

Register your product and get support at
www.philips.com/welcome

BDP5320/F7
BDP5320/F8



EN User manual

FR Manuel de l'Utilisateur

ES Manual del usuario

EN: For further assistance, call the customer support service in your country.

- To obtain assistance in the U.S.A., Canada, Puerto Rico, or the U.S. Virgin Islands, contact Philips Customer Care Center at 1-866-309-0866
- To obtain assistance in Mexico, contact Philips Customer Care Center at 01 800 504 62 00

FR: Pour obtenir de l'aide supplémentaire, communiquez avec le centre de service à la clientèle de votre pays.

- Pour obtenir de l'aide aux États-Unis, au Canada, à Puerto Rico ou aux Îles Vierges américaines, communiquez avec le centre de service à la clientèle Philips au : 1-866-309-0866
- Pour obtenir l'aide au Mexique, entrez en contact avec le centre de soin de client de Philips à 01 800 504 62 00

ES: Para obtener más información, llame al servicio de soporte al cliente de su país.

- Para obtener asistencia en los Estados Unidos, en Canadá, Puerto Rico o en las Islas Vírgenes de los Estados Unidos, comuníquese con Centro de atención al cliente de Philips al 1-866-309-0866
- Solo para México CENTRO DE ATENCIÓN A CLIENTES LADA. 01 800 504 62 00 Solo Para México.

PHILIPS

PRECAUTIONS

Return your Product Registration Card or register online at www.philips.com/welcome today to get the very most from your purchase.

Registering your model with PHILIPS makes you eligible for all of the valuable benefits listed below, so don't miss out. Complete and return your Product Registration Card at once, **or register online at www.philips.com/welcome** to ensure:

*Proof of Purchase

Returning the enclosed card guarantees that your date of purchase will be on file, so no additional paperwork will be required from you to obtain warranty service.

*Product Safety Notification

By registering your product, you'll receive notification - directly from the manufacturer - in the rare case of a product recall or safety defect.

*Additional Benefits

Registering your product guarantees that you'll receive all of the privileges to which you're entitled, including special money-saving offers.

PHILIPS

Congratulations on your purchase, and welcome to the "family!"

Dear PHILIPS product owner:

Thank you for your confidence in PHILIPS. You've selected one of the best-built, best-backed products available today. We'll do everything in our power to keep you happy with your purchase for many years to come.

As a member of the PHILIPS "family," you're entitled to protection by one of the most comprehensive warranties and outstanding service networks in the industry. What's more, your purchase guarantees you'll receive all the information and special offers for which you qualify, plus easy access to accessories from our convenient home shopping network.

Most importantly, you can count on our uncompromising commitment to your total satisfaction.

All of this is our way of saying welcome - and thanks for investing in a PHILIPS product.

P.S. To get the most from your PHILIPS purchase, be sure to complete and return your Product Registration Card at once, or register online at: www.philips.com/welcome

Know these **safety** symbols



CAUTION

RISK OF ELECTRIC SHOCK
DO NOT OPEN



CAUTION: TO REDUCE THE RISK OF ELECTRIC SHOCK, DO NOT REMOVE COVER (OR BACK). NO USER-SERVICEABLE PARTS INSIDE. REFER SERVICING TO QUALIFIED SERVICE PERSONNEL.



This "bolt of lightning" indicates uninsulated material within your unit may cause an electrical shock. For the safety of everyone in your household, please do not remove product covering.



The "exclamation point" calls attention to features for which you should read the enclosed literature closely to prevent operating and maintenance problems.

WARNING: To reduce the risk of fire or electric shock, this apparatus should not be exposed to rain or moisture, and objects filled with liquids, such as vases, should not be placed on this apparatus.

CAUTION: To prevent electric shock, match wide blade of plug to wide slot, fully insert.

ATTENTION: Pour éviter les chocs électriques, introduire la lame la plus large de la fiche dans la borne correspondante de la prise et pousser jusqu'au fond.



The symbol for CLASS II (Double Insulation)

The important note and rating are located on the rear or bottom of the cabinet.

For Customer Use

Enter below the Serial No. which is located on the cabinet. Retain this information for future reference.

Model No. _____
Serial No. _____

PHILIPS Visit our World Wide Web Site at <http://www.philips.com/welcome>

IMPORTANT SAFETY INSTRUCTIONS

1. Read these instructions.
2. Keep these instructions.
3. Heed all warnings.
4. Follow all instructions.
5. Do not use this apparatus near water.
6. Clean only with dry cloth.
7. Do not block any ventilation openings. Install in accordance with the manufacturer's instructions.
8. Do not install near any heat sources such as radiators, heat registers, stoves, or other apparatus (including amplifiers) that produce heat.
9. Do not defeat the safety purpose of the polarized or grounding-type plug. A polarized plug has two blades with one wider than the other. A grounding type plug has two blades and a third grounding prong. The wide blade or the third prong are provided for your safety. If the provided plug does not fit into your outlet, consult an electrician for replacement of the obsolete outlet.
10. Protect the power cord from being walked on or pinched particularly at plugs, convenience receptacles, and the point where they exit from the apparatus.
11. Only use attachments/accessories specified by the manufacturer.
12. Use only with the cart, stand, tripod, bracket, or table specified by the manufacturer, or sold with the apparatus. When a cart is used, use caution when moving the cart/apparatus combination to avoid injury from tip-over.
13. Unplug this apparatus during lightning storms or when unused for long periods of time.
14. Refer all servicing to qualified service personnel. Servicing is required when the apparatus has been damaged in any way, such as power-supply cord or plug is damaged, liquid has been spilled or objects have fallen into the apparatus, the apparatus has been exposed to rain or moisture, does not operate normally, or has been dropped.



FCC WARNING

This equipment may generate or use radio frequency energy. Changes or modifications to this equipment may cause harmful interference unless the modifications are expressly approved in the manual. The user could lose the authority to operate this equipment if an unauthorized change or modification is made.

RADIO-TV INTERFERENCE

This equipment has been tested and found to comply with the limits for a Class B digital device, pursuant to Part 15 of the FCC Rules. These limits are designed to provide reasonable protection against harmful interference in a residential installation. This equipment generates, uses, and can radiate radio frequency energy and, if not installed and used in accordance with the instructions, may cause harmful interference to radio communications. However, there is no guarantee that interference will not occur in a particular installation. If this equipment does cause harmful interference to radio or television reception, which can be determined by turning the equipment off and on, the user is encouraged to try to correct the interference by one or more of the following measures:

- 1) Reorient or relocate the receiving antenna.
- 2) Increase the separation between the equipment and receiver.
- 3) Connect the equipment into an outlet on a circuit different from that to which the receiver is connected.
- 4) Consult the dealer or an experienced radio/TV technician for help.

This Class B digital apparatus complies with Canadian ICES-003.

Disconnect the mains plug to shut off when find trouble or not in use. The mains plug shall remain readily operable.

CAUTION: Danger of explosion if battery is incorrectly replaced. Replace only with the same or equivalent type.

WARNING: Batteries (Battery pack or battery installed) shall not be exposed to excessive heat such as sunshine, fire, or the like.

LASER SAFETY

This apparatus employs a laser. Only a qualified service person should remove the cover or attempt to service this apparatus, due to possible eye injury.

CAUTION: Use of controls or adjustments or performance of procedures other than those specified herein may result in hazardous radiation exposure.

CAUTION: Laser radiation when open. Do not stare into beam.

LOCATION: Inside, near the BD mechanism.

PRECAUTIONS

IMPORTANT COPYRIGHT INFORMATION

Unauthorized copying, broadcasting, public performance and lending of discs are prohibited. This product incorporates copyright protection technology that is protected by U.S. patents and other intellectual property rights. Use of this copyright protection technology must be authorized by Macrovision, and is intended for home and other limited viewing uses only unless otherwise authorized by Macrovision. Reverse engineering or disassembly is prohibited.

Do not place the unit on the furniture that is capable of being tilted by a child and an adult leaning, pulling, standing or climbing on it. A falling unit can cause serious injury or even death.

To Avoid the Hazards of Electrical Shock and Fire

- Do not handle the AC power cord with wet hands.
- Do not pull on the AC power cord when disconnecting it from an AC outlet. Grasp it by the plug.
- Do not put your fingers or objects into the unit.

Location and Handling

- Do not install the unit in direct sunlight, near strong magnetic fields, or in a place subject to dust or strong vibration.
- Avoid a place with drastic temperature changes.
- Install the unit in a horizontal and stable position. Do not place anything directly on top or bottom of the unit. Depending on your external devices, noise or disturbance of the picture and/or sound may be generated if the unit is placed too close to them. In this case, please ensure enough space between the external devices and the unit.
- Depending on the environment, the temperature of this unit may increase slightly. This is not a malfunction.
- Be sure to remove the disc and unplug the AC power cord from the outlet before carrying the unit.

Dew Condensation Warning

- Dew condensation may form inside the unit in the following conditions. If so, do not use this unit at least for a few hours until its inside gets dry.
 - The unit is moved from a cold place to a warm place.
 - Under conditions of high humidity.
 - After heating a cold room.

Notice for Progressive Scan Output

- Consumers should note that not all high definition television sets are fully compatible with this product and may cause artifacts to be displayed in the picture. In case of picture problems with 525(480) progressive scan output, it is recommended that the user switch the connection to the 'standard definition' output. If there are questions regarding your TV set compatibility with this 525p(480p) BD/DVD player, please contact our customer service center.



ENERGY STAR® is a joint program of the U.S. Environmental Protection Agency and the U.S. Department of Energy helping us all save money and protect the environment through energy efficient products and practices.

PRECAUTIONS

Maintenance

Servicing

- Please refer to relevant topics on “TROUBLESHOOTING” on page 59 before returning the product.
- If you need to call a customer service representative, please know the model number and serial number of your product before you call. This information is displayed on the back of the product. Also, please take a moment to identify the problem you are having, and be prepared to explain this to the representative. If you believe the representative will need to help you with operations, please stay near the product. Our representatives will be happy to assist you. For online reference, please visit our web site at <http://www.philips.com/welcome>

Cleaning the Cabinet

- Wipe the front panel and other exterior surfaces of the unit with a soft cloth.
- Never use a solvent, thinner, benzene or alcohol to clean the unit. Do not spray insecticide liquid near the unit. Such chemicals may discolor the surface or damage the unit.

Cleaning Discs

- When a disc becomes dirty, clean it with a cleaning cloth. Wipe the disc from the center to out. Do not wipe in a circular motion.
- Do not use solvents such as benzine, thinner, commercially available cleaners, detergent, abrasive cleaning agents or antistatic spray intended for analog records.

Cleaning the Disc Lens

- If this unit still does not perform properly although you refer to the relevant sections and to “TROUBLESHOOTING” in this user manual, the laser optical pickup unit may be dirty. Consult your dealer or an Authorized Service Center for inspection and cleaning of the laser optical pickup unit.

Disc Handling

- Handle the discs so that fingerprints and dust do not adhere to the surfaces of the discs.
- Always store the disc in its protective case when it is not used.
- Note that discs with special shapes (heart-shaped discs, octagonal discs, etc.) cannot be played back on this unit. Do not attempt to play such discs, as they may damage the unit.

Notice

2010 © Koninklijke Philips Electronics N.V. All rights reserved.

Specifications are subject to change without notice. Trademarks are the property of Koninklijke Philips Electronics N.V. or their respective owners. Philips reserves the right to change products at any time without being obliged to adjust earlier supplies accordingly. The material in this manual is believed adequate for the intended use of the system. If the product, or its individual modules or procedures, are used for purposes other than those specified herein, confirmation of their validity and suitability must be obtained. Philips warrants that the material itself does not infringe any United States patents. No further warranty is expressed or implied. Philips cannot be held responsible neither for any errors in the content of this document nor for any problems as a result of the content in this document. Errors reported to Philips will be adapted and published on the Philips support website as soon as possible.

Warranty

No components are user serviceable. Do not open or remove covers to the inside of the product. Repairs may only be done by Philips Service Centers and official repair shops. Failure to do so shall void any warranty, stated or implied.

Any operation expressly prohibited in this manual, any adjustments, or assembly procedures not recommended or authorized in this manual shall void the warranty.

EN

Introduction

Connections

Basic Setup

Playback

Function Setup

Others

PRECAUTIONS

Important

Registering your model with Philips makes you eligible for all of the valuable benefits listed below, so don't miss out. Complete and return your Product Registration Card at once, or register online at www.philips.com/welcome to ensure :

Proof of Purchase

Returning the enclosed card guarantees that your date of purchase is on file, so no additional paperwork is required from you to obtain warranty service.

Product Safety Notification

By registering your product you receive notification - directly from the manufacturer - in the rare case of a product recall or safety defect.

Additional Benefits of Product Ownership

Registering your product guarantees that you receive all of the privileges to which you're entitled, including special money-saving offers.

For further assistance

For further assistance, call the customer support service in your country.

- To obtain assistance in the U.S.A., Canada, Puerto Rico, or the U.S. Virgin Islands, contact Philips Customer Care Center at 1-866-309-0866

Environmental Care



The packaging of this product is intended to be recycled. Contact your local authorities for information about how to recycle the packaging.

End of life directives



Philips pays a lot of attention to produce environment-friendly products in green focal areas. Your new Blu-ray Disc Player contains materials which can be recycled and reused. At the end of its life, specialized companies can dismantle the discarded Blu-ray Disc Player to concentrate the reusable materials and to minimize the amount of materials to be disposed of. Please ensure you dispose of your old Blu-ray Disc Player according to local regulations.

Disposal of used batteries

The batteries supplied do not contain the heavy metals mercury and cadmium. Nevertheless, in many areas batteries may not be disposed of with your household waste. Please ensure you dispose of batteries according to local regulations.

Supplied Accessories



- remote control
- AAA (1.5V) battery × 2

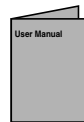

User Manual

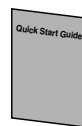

Quick Start Guide

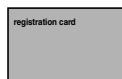

registration card



Netflix Box-insert

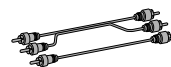

RCA audio / video cables

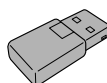

USB wireless LAN adapter (PH2010A)

Note

- Wireless LAN Adapter for Philips model: BDP5320/F7
This wireless device can only be used with a limited number of Philips products. For more details go to: www.philips.com/welcome and enter your model number.
- Do not use the supplied USB wireless LAN adapter with devices other than this unit and a limited number of Philips products.
- The supplied USB wireless LAN adapter is guaranteed by manufacturer.

PRECAUTIONS

Trademark Information



Manufactured under license from Dolby Laboratories. "Dolby" and the double-D symbol are trademarks of Dolby Laboratories.



"BD-LIVE" logo is trademark of Blu-ray Disc Association.



Manufactured under license under U.S. Patent #'s: 5,451,942; 5,956,674; 5,974,380; 5,978,762; 6,226,616; 6,487,535; 7,392,195; 7,272,567; 7,333,929; 7,212,872 & other U.S. and worldwide patents issued & pending. DTS and the Symbol are registered trademarks, & DTS-HD, DTS-HD Master Audio | Essential and the DTS logos are trademarks of DTS, Inc. Product includes software. © DTS, Inc. All Rights Reserved.



Netflix and the Netflix logo are trademarks or registered trademarks of Netflix, Inc.



HDMI, the HDMI Logo, and High-Definition Multimedia Interface are trademarks or registered trademarks of HDMI Licensing LLC in the United States and other countries.



© 2009 Sonic Solutions. Roxio, CinemaNow, Roxio CinemaNow and the Roxio CinemaNow logos are trademarks or registered trademarks owned by Sonic Solutions in the United States and other jurisdictions.

x.v.Color

"x.v.Color" and "x.v.Color" logo are trademarks of Sony Corporation.



BLOCKBUSTER name, design and related marks are trademarks of Blockbuster Inc.



Java and all other Java trademarks and logos are trademarks or registered trademarks of Sun Microsystems, Inc. in the United States and/or other countries.



vTuner is a trademark of Nothing Else Matters Software, Ltd.



Windows Media and the Windows logo are trademarks or registered trademarks of Microsoft Corporation in the United States and/or other countries.

"Blu-ray Disc" and  are trademarks.  is a trademark of DVD Format/Logo Licensing Corporation.



is trademark of Eastman Kodak Company.



DivX®, DivX Certified® and associated logos are registered trademarks of DivX, Inc. and are used under license.



"AVCHD" and the "AVCHD" logo are trademarks of Panasonic Corporation and Sony Corporation.

BONUS VIEW™ "BONUSVIEW" is trademark of Blu-ray Disc Association.

CONTENTS

Introduction

Precautions	2
Maintenance	5
Notice	5
Important	6
Supplied Accessories	6
Trademark Information	7
Features	9
Features	9
Product Info	10
Symbols Used in this User Manual	10
Functional Overview	11
Front Panel	11
Rear Panel	11
Remote Control	12
Front Panel Display	14
Guide to On-Screen Display	15

Connections

Connections	16
Connection to the TV	16
Connection to an Audio System	19
Connection to the Network	20

Basic Setup

Before You Start	22
Finding the Viewing Channel on Your TV	22

Playback

Information on Playback	23
Information on Playback	23
Guide to File List	25
How to Insert a Disc	25
Basic Playback	26
Playing Back a BD, DVD or a Disc with AVCHD Files	26
Playing Back an Audio CD or a Disc with DivX® / MP3 / Windows Media™ Audio / JPEG Files	27
Kodak Picture CD	29
Reading the SD Memory Card	29
About DivX® and DivX® VOD	30
Playing Back DivX® with DivX® External Subtitle	31
Using the Title / Disc Menu	31
Special Playback	32
Fast Forward / Fast Reverse	32
Slow Forward Playback	32
Step by Step Playback	32
Zoom	32
Repeat Playback	33
A-B Repeat	33
Slide Show	33
PiP (BONUSVIEW) Setting	33
Enjoying BD-Live Discs with Internet	34
Title / Chapter Search	34
Track Search	35
Time Search	35
Switching Subtitles	35
Switching Audio Soundtrack	36
Switching Camera Angles	36

Netflix Operations	37
Before Activating the Connection to Netflix	37
Activating the Connection to Netflix	37
Watching Streaming Movies	37
CinemaNow / Blockbuster Operations	38
Before Activating the Connection to CinemaNow / Blockbuster	38
Activating the Connection to CinemaNow / Blockbuster	38
Guide to CinemaNow / Blockbuster Menu Screen	38
Renting or Purchasing Movies / TV episodes	39
Searching Movies / TV episodes	39
Watching Rented or Purchased Movies / TV episodes	39
Enjoying Internet Radio with vTuner	40
Internet Radio Playback	40
Guide to the Playback Screen	41
Add to Favorite List	41
Remove from Favorite List	41
Add Stations on the vTuner Website	41
Reset the Station List	41

Function Setup

List of Settings	42
Setups	48
TV Shape	48
HDMI Video Resolution	48
HDMI Audio	49
Digital Out	51
Ratings Lock	52
Network Connection	53
EasyLink (HDMI CEC)	57
Software Upgrade	58
Reset to Factory Default	58

Others

Troubleshooting	59
Downloading an Electronic Copy	61
Contact Us	61
Glossary	62
Specifications	64
Network Service Disclaimer	65
ONE (1) YEAR LIMITED WARRANTY	66

FEATURES

Congratulations on your purchase, and welcome to Philips!

To fully benefit from the support that Philips offers, register your product at www.philips.com/welcome.

Features

Blu-ray Disc

You can enjoy Blu-ray Disc which is capable of storing five times more data than a conventional DVD.

BD-Java

With some BDs which support Java applications, you can enjoy the interactive functions such as games or interactive menus.

DVD upscaling for enhanced picture quality

Your current DVD will look even better than before thanks to video upscaling. Upscaling will increase the resolution of standard definition DVD to high definition up to 1080p over an HDMI connection. The picture will be less jagged and more realistic for a near high definition experience.

Enjoy your content on different kinds of media

Full backwards compatibility with DVD, CD and SD card ensures that you can continue to enjoy your current audio-video collection. Additionally, you can view JPEG digital pictures or listen to MP3 or Windows Media™ Audio music files.

Listen to rich multi-channel surround sound

Multi-channel surround sound, which realizes real-to-life sound and makes you feel that you are really there.

Intuitive user interface and remote control

The Philips logical user interface allows you to easily navigate through your content and settings, so you can quickly find what you are looking for.

Easy and simple connection to your HDTV via HDMI

Connect your BDP5320 to your HDTV with one single HDMI (High Definition Multimedia Interface) cable. Philips recommends HDMI1.3 (category 2) cable (also known as High Speed HDMI cable) for better compatibility. The high definition video output signal will be transferred to your HDTV without conversion to analog signals, so you will get excellent picture and sound quality, completely free from noise. Thanks to other multiple outputs, you can also easily connect to your home theater system or amplifier.

About EasyLink (HDMI CEC) (Consumer Electronics Control)

EasyLink (HDMI CEC) allows you to operate the linked functions of this player with Philips brand TV with EasyLink feature.

Philips does not guarantee 100 % interoperability with other brands of HDMI CEC compliant devices.

PiP (BONUSVIEW)

Some BD-videos have the PiP function which enables you to display the secondary video in the primary video. You can call up the secondary video by pressing **[BONUSVIEW (PiP)]** whenever the scene contains the secondary video.

BD-Live

BD-Live (BD-ROM version 2 Profile 2.0) that allows interactive functions to be used when this unit is connected to the Internet in addition to the BONUSVIEW function. The various functions differ depending on the disc.

Pop-up menu

Some BD-videos have a pop-up menu which is a navigation menu that can be called up and be operated on the TV screen without interrupting playback. You can call up the pop-up menu by pressing **[DISC MENU / POP-UP MENU]**. Contents in the pop-up menu vary depending on the disc.

HDMI Deep Color

Deep Color reduces posterization effect of the playback image. Refer to "HDMI Deep Color" in the "LIST OF SETTINGS" on page 43.

HDMI 1080p/24 output (BD only)

This unit is equipped with the feature which can provide smooth movement during playback of film originated material with the frame rate of 24 frames per second with progressive. (Available only when the display device is connected by an HDMI cable.) Refer to "HDMI 1080p/24" in the "LIST OF SETTINGS" on page 43.

Playing back contents from an SD Memory Card

You can play back AVCHD / MP3 / WMA / JPEGS stored in an SD Memory Card. BD-ROM Profile 2.0 (BD-Live) and Profile 1.1 discs sometimes store picture-in-picture commentary, subtitles or other extras in the SD Memory Card for use during playback with the BD-video.

Playing back AVCHD files

This unit supports playback of AVCHD format files (new format for high definition video camcorders) recorded on disc / SD card. Your high definition personal archive is playable in HD quality.

x.v.Color

This unit supports playback of video contents on discs recorded with "x.v.Color" technology. To watch this video content with the "x.v.Color" space, a TV or other display device supporting both video image reproduction using "x.v.Color" standard and capability of manual switching of its color space setting is required. Please refer to the owner's manual of your display device for further information.

Netflix

With this unit, you can enjoy movies and TV episodes streamed instantly from Netflix via the Internet. In order to use this feature, you must visit netflix.com/Philips on your PC and become a Netflix member. (This feature is available only in the United States.)

CinemaNow / Blockbuster

With this unit, you can enjoy movies and TV episodes streamed instantly from CinemaNow / Blockbuster via the Internet. In order to use this feature, you must visit following website on your PC and become a CinemaNow / Blockbuster member.

- CinemaNow : www.cinemanow.com/Login
- Blockbuster : www.blockbuster.com/auth/login

vTuner

This unit supports vTuner which is a database service of Internet radio stations. You can enjoy various kinds of Internet radio stations with vTuner via the Internet.

EN

Introduction

Connections

Basic Setup

Playback

Function Setup

Others

FEATURES

Product Info









“Product Info” screen provides information about this unit’s hardware and software version.

You can also download the latest firmware from the web site which is displayed in the “Product Info” screen, and update the firmware yourself.

To access “Product Info”, select “Product Info” in the home menu.

Symbols Used in this User Manual

To specify which media type each function is applicable to, we put the following symbols at the beginning of each item to operate.

Symbol	Description
	Description refers to BD-video
	Description refers to DVD-video
	Description refers to audio CD / DTS-CD
	Description refers to DVD-RW/-R and SD card with AVCHD files
	Description refers to BD-RE/-R, DVD-RW/-R and CD-RW/-R with DivX® files
	Description refers to BD-RE/-R, DVD-RW/-R, CD-RW/-R and SD card with MP3 files
	Description refers to BD-RE/-R, DVD-RW/-R, CD-RW/-R and SD card with Windows Media™ Audio files
	Description refers to BD-RE/-R, DVD-RW/-R, CD-RW/-R and SD card with JPEG files

If you do not find any of the symbols listed above under the function heading, the operation is applicable to all media.

FUNCTIONAL OVERVIEW

Front Panel

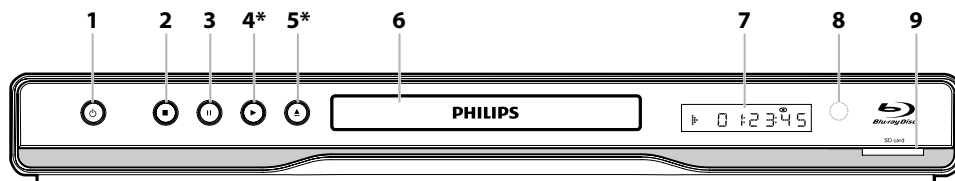

* The unit can also be turned on by pressing these buttons.

1. ⏻ (standby/on) button

- Press to turn on the unit, or to turn the unit into the standby mode. (To completely turn off the unit, you must unplug the AC power cord.)
- Press and hold for 10 seconds to shut down the unit.
- This button lights up in red when the unit is in standby mode and turns off when the power is on.

2. ■ (stop) button

- Press to stop playback.

3. || (pause) button

- Press to pause playback.

4. ▶ (play) button*

- Press to start or resume playback.

5. ▲ (open/close) button*

- Press to open or close the disc tray.

6. Disc tray

- Place a disc after opening the disc tray.

7. Display

- Refer to "Front Panel Display" on page 14.

8. Infrared sensor window

- Receive signals from your remote control so that you can control the unit from a distance.

9. SD card slot

- Insert an SD Memory Card and play back the contents in it.

Note

- This unit will be turned into the standby mode automatically after 25 minutes of no action.

Rear Panel

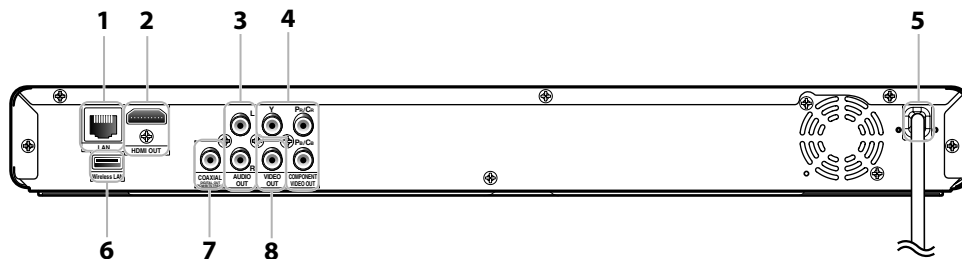

1. LAN terminal

- Use to connect a modem with LAN cable.

2. HDMI OUT jack

- Use to connect to a display with an HDMI compatible port with an HDMI cable.

3. AUDIO OUT jacks

- Use to connect a TV monitor, an AV receiver / amplifier or other device with an RCA audio cable.

4. COMPONENT VIDEO OUT jacks

- Use to connect a TV monitor with component video inputs with an RCA component video cable.

5. AC power cord

- Connect to a standard AC outlet to supply power to this unit.
- Unplug this cord from the AC outlet to completely turn off the unit.

6. Wireless LAN terminal

- Use to connect the supplied USB wireless LAN adapter.

7. DIGITAL OUT (COAXIAL) jack

- Use to connect an AV receiver / amplifier, Dolby Digital / DTS decoder or other device with a digital audio coaxial input jack with a digital audio coaxial cable.

8. VIDEO OUT jack

- Use to connect a TV monitor, an AV receiver / amplifier or other device with an RCA video cable.

Note

- Do not touch the inner pins of the jacks on the rear panel. Electrostatic discharge may cause permanent damage to the unit.
- This unit does not have the RF modulator.
- Do not insert a USB flash memory to the Wireless LAN terminal. This unit is not designed to play back data in USB flash memory.

FUNCTIONAL OVERVIEW

Remote Control

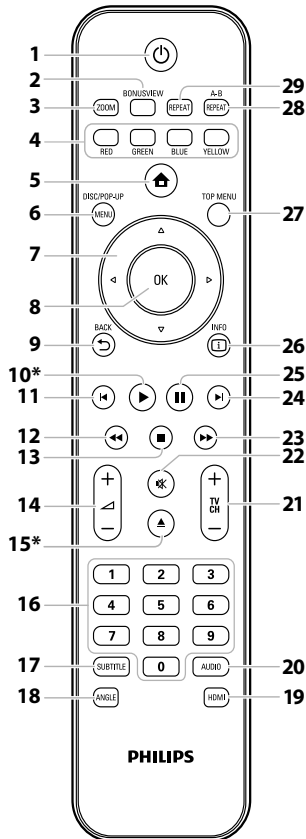

* The unit can also be turned on by pressing these buttons.

1. **⏻ (standby/on) button**

- Press to turn on the unit, or to turn the unit into the standby mode. (To completely turn off the unit, you must unplug the AC power cord.)

2. **BONUSVIEW (PiP) button**

- Press to switch picture in picture feature on/off (only applicable to BD-video which supports the PiP (BONUSVIEW) function).

3. **ZOOM button**

- Press to enlarge the picture on the TV screen.

4. **RED / GREEN / BLUE / YELLOW button**

- Press to activate short cut keys on some BD-video function.
- When file list / setup list is shown, press to switch between pages.

5. **🏠 (home) button**

- Press to display the home menu.

6. **DISC MENU / POP-UP MENU button**

BD:

- Press to display the pop-up menu.

DVD:

- Press to display the disc menu.

7. **▲ / ▼ / ◀ / ▶ buttons**

- Press to select items or settings.

8. **OK button**

- Press to confirm or select menu items.

9. **⏪ (back) button**

- Press to return to the previously displayed menu or screen function.

10. **▶ (play) button***

- Press to start playback or resume playback.

11. **◀ (previous) button**

- During playback, press once to return to the beginning of the current title, chapter, track or file.
- During playback, press twice to return to the previous title, chapter, track or file.
- During the JPEG playback, press to return to the previous file.

12. **◀◀ (reverse) button**

- During playback, press to fast reverse the playback.

13. **■ (stop) button**

- Press to stop playback.

14. **⏶ / + / - (volume) button**

- Press to adjust the TV volume (only applicable to the PHILIPS brand TV).

15. **▲ (open/close) button***

- Press to open or close the disc tray.

16. **Number buttons**

- Press to select a chapter during playback.
- Press to enter values in the input field.

17. **SUBTITLE button**

- Press to select subtitles on a disc.

18. **ANGLE button**

- Press to select camera angles on a disc.
- Press to rotate a picture (JPEG).

19. **HDMI button**

- Press to set the HDMI output mode.

20. **AUDIO button**

- Press to select the audio channel (such as audio languages) on a disc.

21. **TV CH + / - buttons**

- Press to change the channel up and down (only applicable to the PHILIPS brand TV).

22. **🔇 (mute) button**

- Press to mute the TV volume (only applicable to the PHILIPS brand TV).

23. **▶▶ (forward) button**

- During playback, press to fast forward the playback.
- When playback is in pause, press to slow forward the playback.

24. **▶ (next) button**

- During playback, press to skip to the next chapter, track or file.

25. **⏸ (pause) button**

- Press to pause playback.
- When playback is in pause mode, press repeatedly to forward the playback step by step.

26. **INFO ⓘ button**

- Press to display the information display.

27. **TOP MENU button**

BD:

- Press to display the top menu.

DVD:

- Press to display the title menu.

28. **REPEAT A-B button**

- Press to play back a defined section between point A and B repeatedly.

29. **REPEAT button**

- Press to toggle between various repeat modes.

Installing the Batteries in the Remote Control

Install 2 AAA (1.5V) batteries matching the polarity indicated inside battery compartment of the remote control.

1) Open the cover.

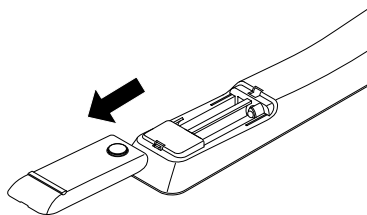

2) Insert batteries.

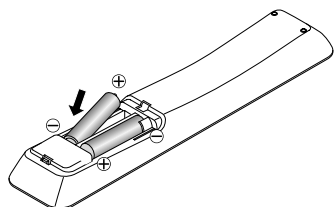

Make sure to match + and - on the batteries to the marks indicated in the battery compartment.

3) Close the cover.

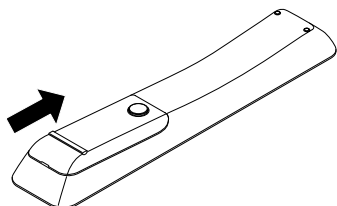

Note

Incorrect use of batteries can result in hazards such as leakage and bursting. Please observe the following:

- Do not mix new and old batteries together.
- Do not use different kinds of batteries together. Although they may look similar, different batteries may have different voltages.
- Make sure that the + and - ends of each battery match the indications in the battery compartment.
- Remove batteries from battery compartment that is not going to be used for a month or more.
- When disposing of used batteries, please comply with governmental regulations or environmental public instruction's rules that apply in your country or area.
- Do not recharge, short-circuit, heat, burn or disassemble batteries.

Using a Remote Control

Remote Control Usage Guidelines:

- Make sure that there are no obstacles between the remote control and the infrared sensor window on the unit.
- Remote operation may become unreliable if strong sunlight or fluorescent light is shining on the infrared sensor window of the unit.
- Remote control for different devices can interfere with each other. Avoid using remote control for other device located close to the unit.
- Replace the batteries when you notice a fall off in the operating range of the remote control.
- The maximum operable ranges from the unit are as follows.
 - **Line of sight:**
approx. 23 feet (7 m)
 - **Either side of the center:**
approx. 16 feet (5 m) within 30°
 - **Above:**
approx. 16 feet (5 m) within 15°
 - **Below:**
approx. 10 feet (3 m) within 30°

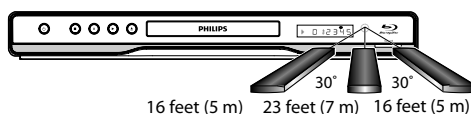

FUNCTIONAL OVERVIEW

Front Panel Display

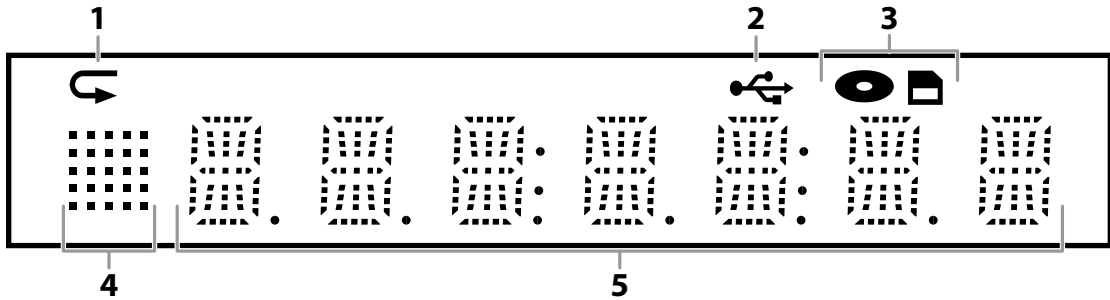

* Brightness of the display can be adjusted. Refer to "Front Panel Brightness" in "LIST OF SETTINGS" on page 46.

1. Displays repeat icon. (Appears during repeat playback.)
2. Displays USB icon (when the supplied USB wireless LAN adapter is connected).
3. Displays media mode icon (disc mode or SD card mode).
4. Displays playback status icon. Refer to the table below.
5. Displays information such as title number, elapsed playing time, repeat type, menu type, etc.

Playback status icon	Mode
	Playback is in progress
	Stop mode
	Pause mode
	Fast forward mode
	Fast reverse mode
	Slow forward mode
	Loading

e.g.)

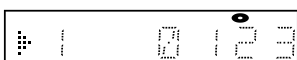

Disc is being played back.
Indicating the current title number and the elapsed time.

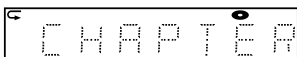

Current chapter is in chapter repeat mode during playback of disc.

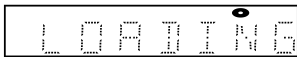

Loading a disc.



Dolby Digital audio is being played back during playback of disc.

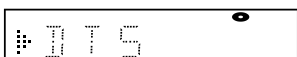

DTS audio is being played back during playback of disc.

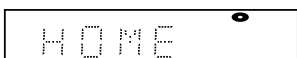

Home menu is displayed and the unit is in disc mode.

Guide to On-Screen Display

Home Menu

When you turn on the unit, home menu will appear automatically. Otherwise, press [**⬆** (home)].

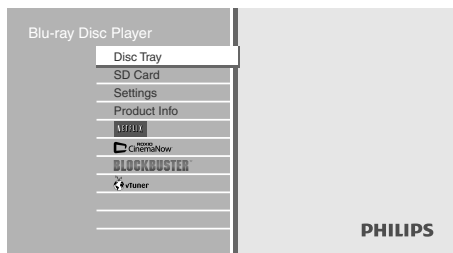

- "Disc Tray"** : To access the track / file list or media filter screen
- "SD Card"** : To access the file list or media filter screen
- "Settings"** : To access the settings menus
- "Product Info"** : To access the product information
- "NETFLIX"** : To access the Netflix screen
- "CinemaNow"** : To access the CinemaNow menu screen
- "BLOCKBUSTER"** : To access the Blockbuster menu screen
- "vTuner"** : To access the menu screen of vTuner

Menu Screen

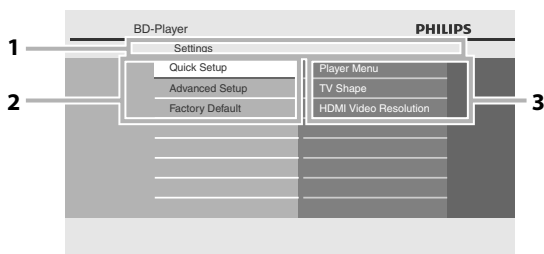

- 1. Directory**
Displays the current hierarchy.
- 2. Menus**
- 3. Options**
Displays options for the highlighted item on the left whenever available.

CONNECTIONS

Connection to the TV

- 1 Choose the appropriate connection, then proceed to the corresponding instruction (A, B or C) on the next page.

Best (Supports up to 1080i^(*1), 1080p^(*2), 1080p/24 resolution.)

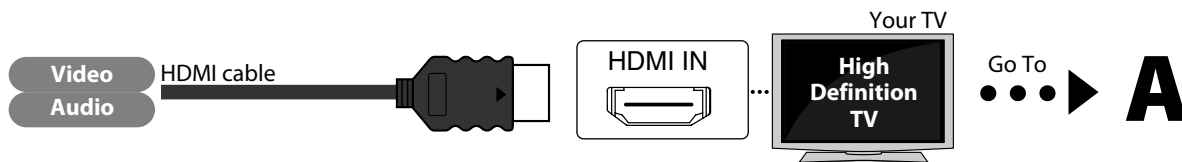

No analog audio connection required.

(*1) 1080i : Outputs the video data with frame rate of 30 frames per second.

(*2) 1080p : Outputs the video data with frame rate of 60 frames per second.

No supplied cables are used in this connection:

Please purchase the necessary cables at your local store.

Use an HDMI cable with the HDMI logo (a certified HDMI cable) for this connection.

High Speed HDMI Cable (also known as HDMI category 2 cable) is recommended for better compatibility.

Better (Supports up to 1080i resolution.)

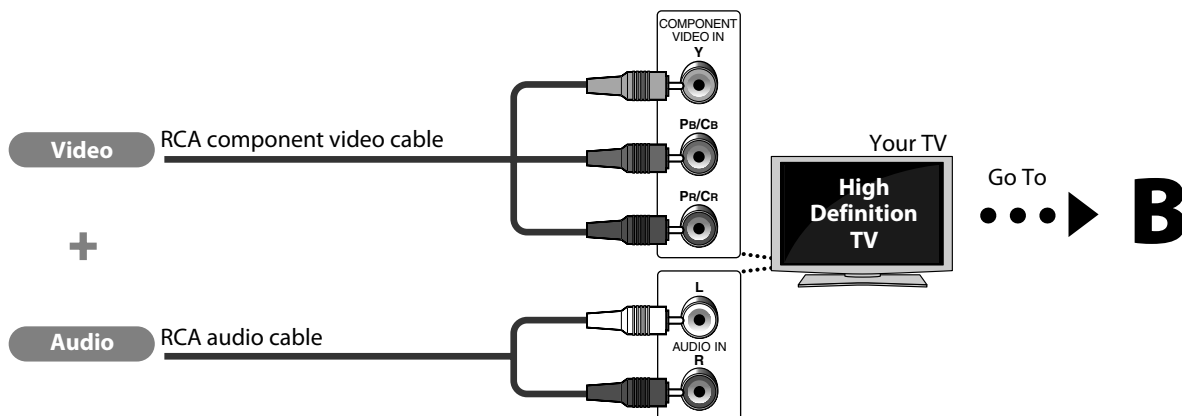

Supplied cables used in this connection are as follows:

- RCA audio cable (L/R) x 1

Please purchase the rest of the necessary cables at your local store.

Basic (Supports only 480i resolution.)

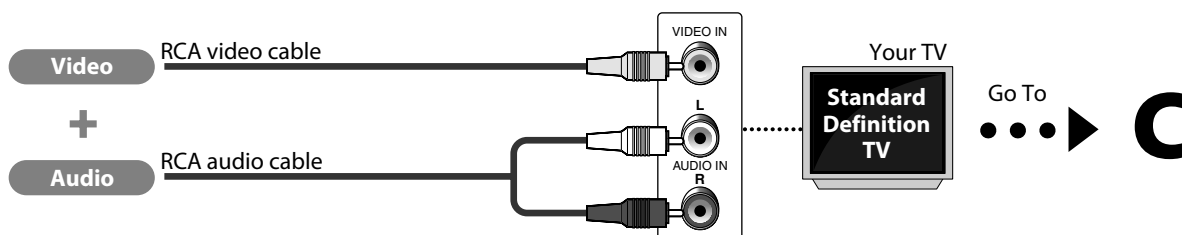

- Connect this unit directly to the TV. If the RCA audio / video cables are connected to a VCR, pictures may be distorted due to the copy right protection system.

Supplied cables used in this connection are as follows:

- RCA audio cable (L/R) x1
- RCA video cable x1

2 Connect the cables by following the descriptions below.

HDMI Video / Audio Connection

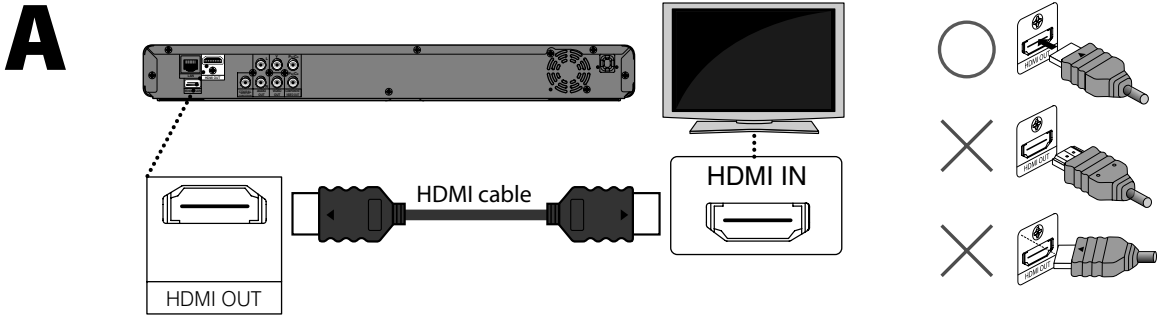

Component Video + Standard Audio Connection

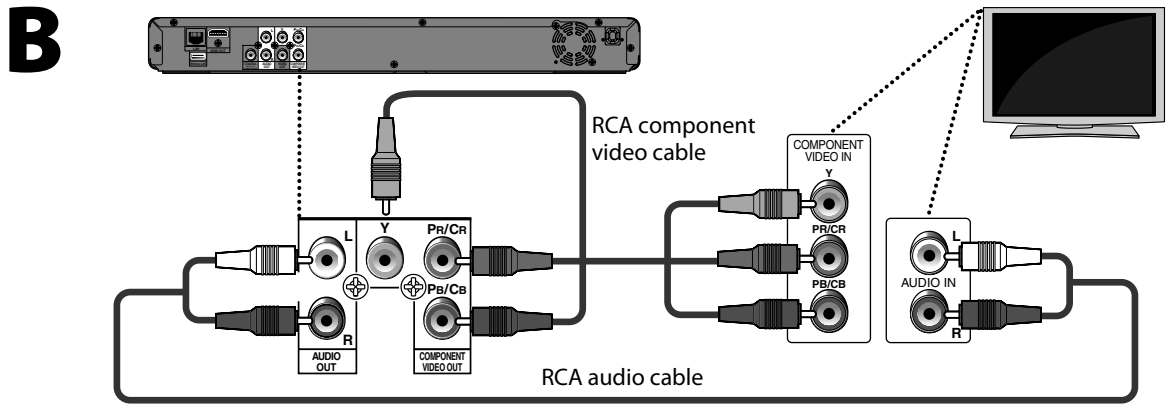

Standard Video + Standard Audio Connection

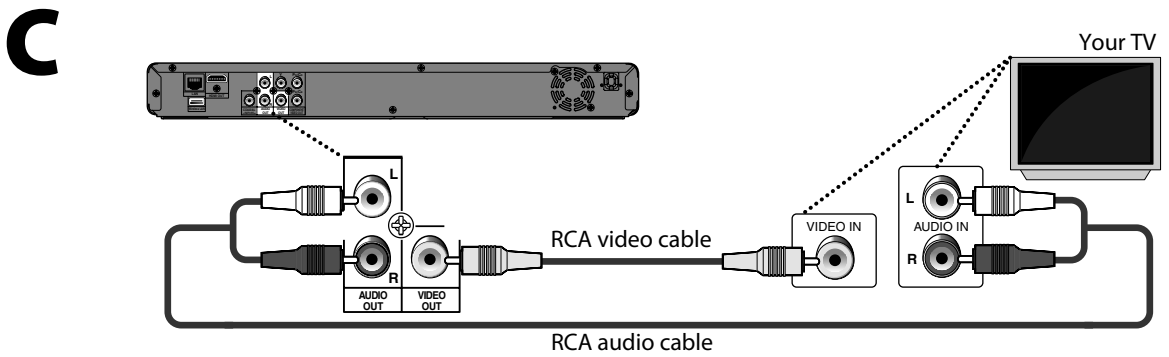

CONNECTIONS

HDMI Mode and Actual Output Signals

Press **[HDMI]** to change the resolution of the video signal being output from the HDMI OUT jack. The video resolution changes as follows every time **[HDMI]** is pressed. Or change the setting in the "HDMI Video Resolution" in the settings menu.

Font Panel Display	HDMI Video Resolution
480P	480 Progressive
Press [HDMI]	
720P	720 Progressive
Press [HDMI]	
1080I	1080 Interlaced
Press [HDMI]	
1080P	1080 Progressive
Press [HDMI]	

Copyright protection system

To play back the digital video images of a BD-video or DVD-video via an HDMI connection, it is necessary that both the player and the display device (or an AV receiver / amplifier) support a copyright protection system called HDCP (high-bandwidth digital content protection system). HDCP is copy protection technology that comprises data encryption and authentication of the connected AV device. This unit supports HDCP. Please read the operating instructions of your display device (or AV receiver / amplifier) for more information.

Note

- When connected to an HDCP incompatible display device, the picture will not be displayed properly.
- The audio signals from the HDMI jack (including the sampling frequency, the number of channels and bit length) may be limited by the device that is connected.
- Among the display device(s) that support HDMI, some do not support audio output (for example, projectors). While connected to a device such as a projector, audio will not be output from the HDMI OUT jack.
- When this unit's HDMI jack is connected to a DVI-D compatible display device(s) (HDCP compatible) with an HDMI-DVI converter cable, the signals are output in digital RGB.
- Pressing **[HDMI]** does not work when HDMI cable is not connected, or when no video signal is being output from the HDMI OUT jack.
- Pressing **[HDMI]** does not work during the playback of a BD-video.
- When you make a selection, the TV monitor temporarily goes blank and then comes back again. If it does not, press **[HDMI]** repeatedly to change the resolution or press and hold **[▶ (play)]** on the front panel for 5 seconds to change the setting back to its default.

CONNECTIONS

Connection to an Audio System

- When you change the connections, all devices should be turned off.
- Refer to the manual accompanying external devices for more information.

2-Channel Analog Audio Connection

Digital Audio Connection

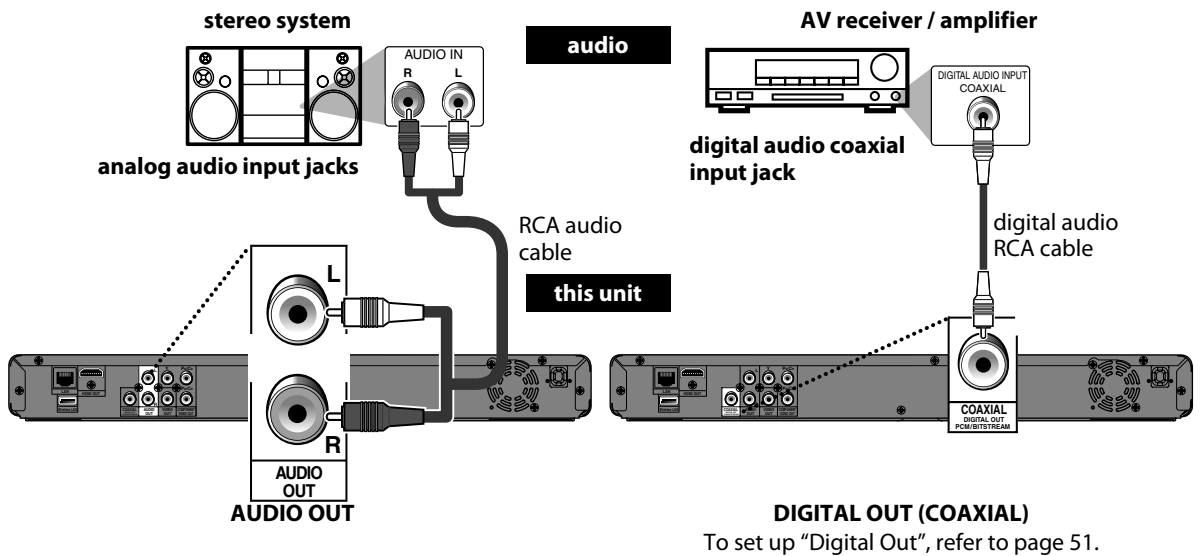

Audio Output from Analog Out (2ch Jacks)

Media	“Blu-ray Disc Audio” setting → Audio Source ↓	“Primary Audio Only”	“Mix Audio Output”
BD-video	Dolby Digital	DownMix 2ch PCM	DownMix 2ch PCM
	Dolby Digital Plus	DownMix 2ch PCM ^{*1}	DownMix 2ch PCM ^{*2}
	Dolby TrueHD	DownMix 2ch PCM ^{*3}	DownMix 2ch PCM ^{*4}
	DTS [®]	DownMix 2ch PCM	DownMix 2ch PCM
	DTS-HD [®]	DownMix 2ch PCM ^{*1}	DownMix 2ch PCM ^{*5}
	LPCM	DownMix 2ch PCM	DownMix 2ch PCM
DVD-video	Dolby Digital	DownMix 2ch PCM	
	DTS [®]	DownMix 2ch PCM	
	LPCM	2ch PCM	
DTS-CD	DTS [®]	DownMix 2ch PCM	
AVCHD	Dolby Digital	DownMix 2ch PCM	
	LPCM	DownMix 2ch PCM	
DivX [®]	Dolby Digital	DownMix 2ch PCM	
	MP3 / MP2	2ch PCM	
Audio CD	PCM	2ch PCM	
MP3	MP3	2ch PCM	
Windows Media™ Audio	WMA	2ch PCM	
Netflix	WMA	2ch PCM	
CinemaNow	AAC	2ch PCM	
Blockbuster	AAC	2ch PCM	
vTuner	MP3 / WMA	2ch PCM	

^{*1}) Full decoded.

^{*2}) Only the independent substream is decoded.

^{*3}) Dolby TrueHD stream is decoded.

^{*4}) Only the Dolby Digital substream is decoded.

^{*5}) Only the core substream is decoded.

CONNECTIONS

HDMI Audio Connection

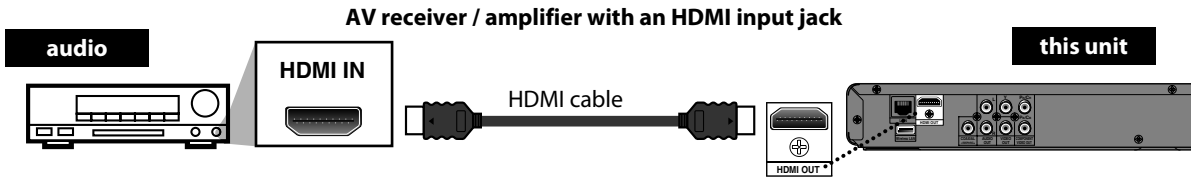

To set up "HDMI Audio", refer to page 49.

Supplied cables used in these connections are as follows:

- RCA audio cable (L/R) x 1
- Please purchase the rest of the necessary cables at your local store.

Connection to the Network

By connecting this unit to the Internet, you can upgrade the software via the Internet or access BD-Live, Netflix, CinemaNow, Blockbuster and vTuner services.

- For more information about software upgrade, refer to "Network Upgrade" on page 58.
- For more information about BD-Live, refer to "Enjoying BD-Live Discs with Internet" on page 34.
- For more information about Netflix, refer to "NETFLIX OPERATIONS" on page 37.
- For more information about CinemaNow and Blockbuster, refer to "CINEMANOW / BLOCKBUSTER OPERATIONS" on page 38.
- For more information about vTuner, refer to "ENJOYING INTERNET RADIO WITH vTuner" on page 40.

Note

- Wired connection is recommended when using following features.
(Using following features with wireless connection can be affected by other devices using radio frequencies.)
 - Video streaming service (Netflix, CinemaNow and Blockbuster)
 - Internet radio service (vTuner)
 - Network upgrade

Wired Connection

Make the following connection if you are using a wired router.

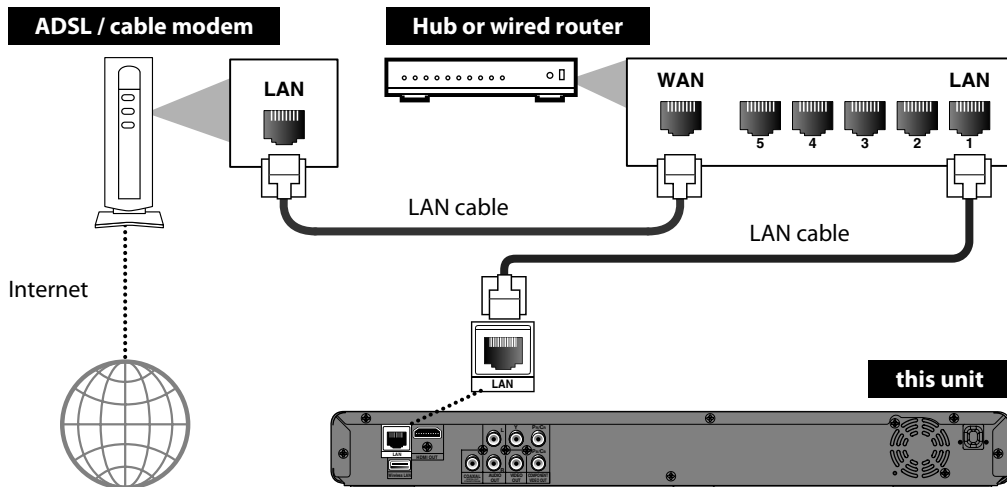

No supplied cables are used in this connection:

Please purchase the necessary cables at your local store.

Note

- After you made a wired connection, set up necessary network settings.
(For the network setting of wired connection, refer to “Enable (Wired)” on page 53.)
- Do not insert any cable other than a LAN cable to the LAN terminal to avoid damaging the unit.
- If your modem does not have router functions, connect a wired router.
- If your modem has router functions but there is no vacant port, use a hub.
- For a wired router, use a router which supports 10BASE-T / 100BASE-TX.
- Do not connect your PC directly to the LAN terminal of this unit.
- Please purchase shielded LAN cables at your local store and use them when you connect to network equipment.

Wireless Connection

Make the following connection if you are using a wireless router.

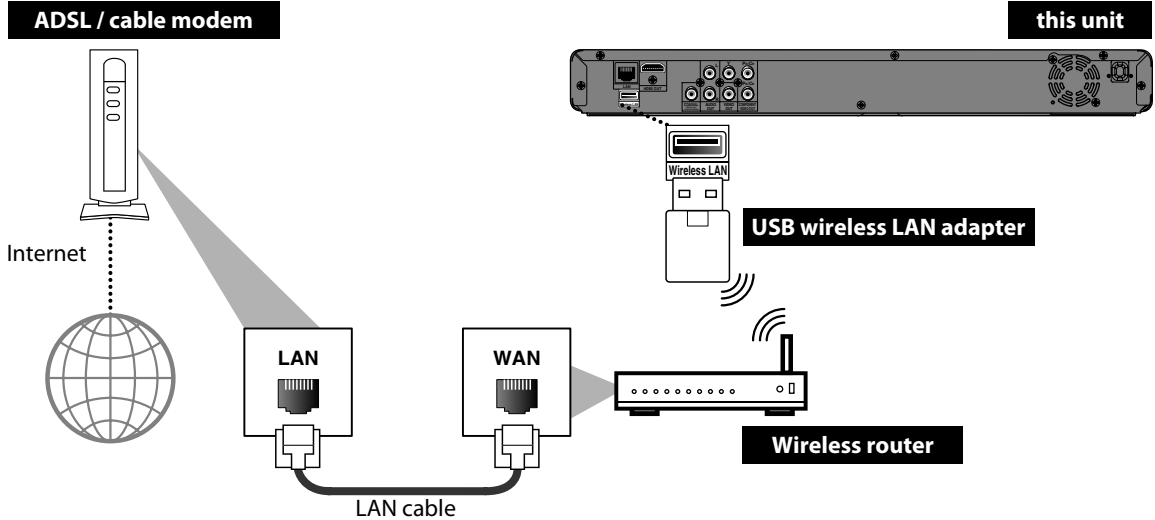

No supplied cables are used in this connection:
Please purchase the necessary cables at your local store.

Note

- After you made the wireless connection, set up necessary network settings.
(For the network setting of wireless connection, refer to “Enable (Wireless)” on page 55.)
- This unit is compatible with the supplied USB wireless LAN Adapter only.
(Commercially available USB wireless adapters are not supported.)
- Do not insert the supplied USB wireless LAN adaptor when the unit is turned on.
Please insert the USB wireless adaptor when the unit is in the standby mode or turned off.
- Do not insert any device other than the supplied USB wireless LAN adapter to the Wireless LAN terminal to avoid damaging the unit.
- For a wireless router, use a router which supports IEEE 802.11 b/g/n.
(n is recommended for stable operation of the wireless network.)
- Set the wireless router to Infrastructure mode. This unit does not support Ad-hoc mode.
- Other radio devices or obstacles may cause interference to the wireless network connection.
- Do not insert USB flash memory in the Wireless LAN terminal. This unit is not designed to play back data from USB flash memory.

BEFORE YOU START

After you have completed all the connections, you must find the viewing channel (external input channel) on your TV.

Finding the Viewing Channel on Your TV

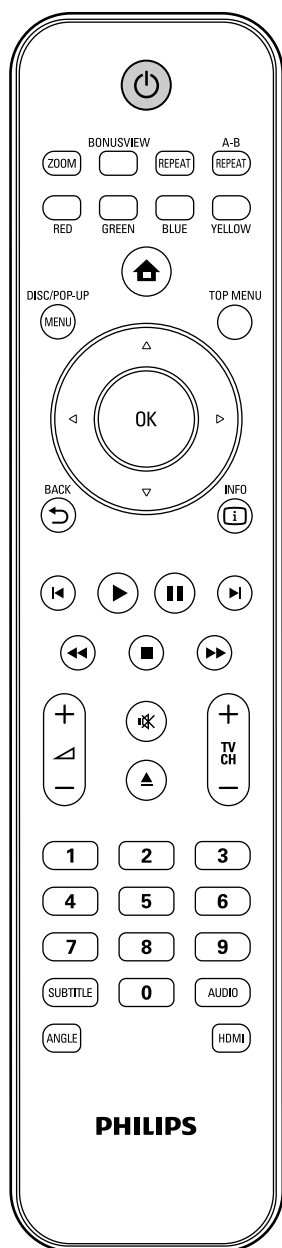

1 After you have made all the necessary connections, press $\text{[} \text{⏻} \text{ (standby/on)]}$ to turn on the unit.

2 Turn on your TV.

3 Press the button on the TV's remote control that accesses the external input channel. It may be labeled "SOURCE", "AV" or "SELECT" (refer to your TV's user manual). Or press "2" on the TV's remote control, then press channel down button repeatedly until you see the PHILIPS splash screen.

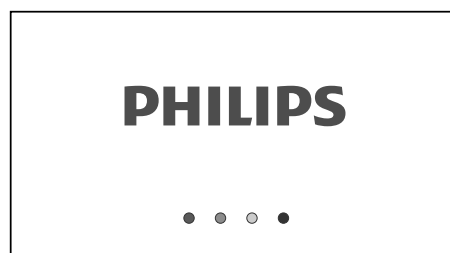

This is the correct viewing channel (external input channel).

- If a certain amount of time has passed since you turned on the unit, you may see the home menu instead of the PHILIPS splash screen.

Home menu:

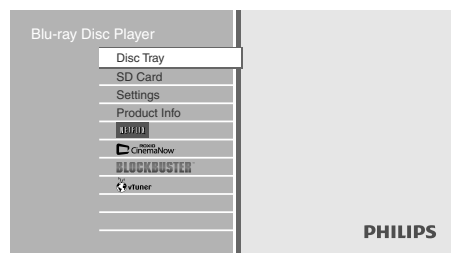

INFORMATION ON PLAYBACK

Information on Playback

Before you start playing back a disc, read the following information.

Playable Discs and Files

This unit is compatible to play back the following discs / files. To play back a disc / file, make sure that it meets the requirements for region codes and color systems as described below. You can play back discs that have the following logos. Other disc types are not guaranteed to play back.

Playable discs	Logos
Blu-ray Disc - BD-video - BD-RE* (ver. 2.1) (Recorded in BDMV format) - BD-R* (ver. 1.1 / 1.2 / 1.3) (Recorded in BDMV format) (Unclosed discs may not be played back.)	
DVD-video	
DVD-RW (finalized video mode discs only)	
DVD-R (finalized video mode discs only)	
CD-DA (audio CD)	
CD-RW	
CD-R	
Kodak Picture CD	
DTS-CD	-

(*) Due to the intentional progression of the Blu-ray Disc format by its standard setting authority, the company cannot guarantee or warrant the playability of future extensions of the Blu-ray Disc format with this product.

Playable files	Media
AVCHD	DVD-RW/-R SD Memory Card (including SDHC) miniSD Card microSD Card
DivX®	BD-RE/-R DVD-RW/-R CD-RW/-R
MP3	BD-RE/-R DVD-RW/-R CD-RW/-R
Windows Media™ Audio	SD Memory Card (including SDHC) miniSD Card microSD Card
JPEG	SD Memory Card (including SDHC) miniSD Card microSD Card

- **ABOUT DIVX VIDEO:** DivX® is a digital video format created by DivX, Inc. This is an official DivX Certified device that plays DivX video. Visit www.divx.com for more information and software tools to convert your files into DivX video.
- **ABOUT DIVX VIDEO-ON-DEMAND:** This DivX Certified® device must be registered in order to play DivX Video-on-Demand (VOD) content. To generate the registration code, locate the DivX VOD section in the device setup menu. Go to vod.divx.com with this code to complete the registration process and learn more about DivX VOD.
- DivX Certified® to play DivX® video, including premium content.
- Discs containing the DivX® files with the DivX® GMC (Global Motion Compensation) playback feature, which is DivX® supplemental function, cannot be played back on this unit.
- This unit cannot play back the disc contents protected by Windows Media™ Digital Rights Management (DRM).

Readable cards	Playable files / data
SD Memory Card (8 MB - 2 GB)	AVCHD, MP3, WMA, JPEG, picture-in-picture
SDHC Memory Card (4 GB - 8 GB)	commentary, subtitles or other extras for BD-ROM
miniSD Card (8 MB - 2 GB)	ver. 2 (Profile 2.0 / Profile 1.1)
microSD Card (8 MB - 2 GB)	

Note for SD Memory Cards

- This unit supports SD Memory Card with FAT12 / FAT16 file system, and SDHC Memory Card with FAT32 file system.
- This unit does not support NTFS file system.
- This unit may not read SD Memory Cards formatted on a computer. If that is the case, please reformat the SD Memory Cards in this unit and try again.
- This unit does not support miniSDHC and microSDHC Memory Card.
- For miniSD Card and microSD Card, an adapter is necessary.

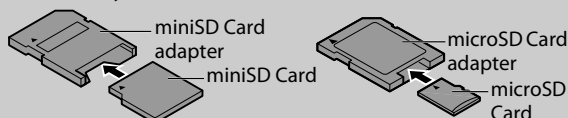

- Portions of this product are protected under copyright law and are provided under license by ARIS / SOLANA / 4C.
- Please keep the SD Memory Cards in their cases when you are not using them.
- Do not try to open or modify the card.
- Do not touch the terminal surface with your fingers or any metals.
- Do not attach additional labels or stickers to cards.
- Do not remove the label of the SD Memory Cards.
- This unit recognizes up to 8 characters of file name in the SD Memory Card. Characters after 8th will not be displayed.

INFORMATION ON PLAYBACK

Unplayable Discs and Files

The following discs will not be played back in this unit.

- CD-ROM
- DVD-RAM
- DVD-audio
- HD DVD
- unfinalized disc
- BD-RE (ver.1.0)
- BD-RE (ver.2.1) (Recorded in BDAV format)
- BD-R (ver.1.1 / 1.2 / 1.3) (Recorded in BDAV format)
- SD Memory Card contains DivX® files
- BD that contains AVCHD files
- BD / DVD hybrid disc (played back as a BD-video only)
- Super Audio CD - Only the sound on the CD layer can be heard. The sound on the high-density Super Audio CD layer cannot be heard.
- Playability of dual discs are not guaranteed.
- CD-I (compact disc-interactive)
- VSD (video single disc)
- video CD
- SVCD

Color Systems

BD-video and DVD-video are recorded in different color systems throughout the world. The most common color system is NTSC (which is used primarily in the United States and Canada).

This unit employs NTSC color system, so the disc you play back must be recorded in the NTSC system. You cannot play back the disc recorded in other color systems.

Region Codes

This unit has been designed to play back BD-video with region "A", DVD-video with region "ALL" or "1" for BDP5320/F7 (USA / Canada) and region "ALL" or "4" for BDP5320/F8 (Mexico). You cannot play back BD-video or DVD-video that are labeled for other regions. Look for the symbols on the right on your BD-video or DVD-video.

If these region symbols do not appear on your BD-video or DVD-video, you cannot play back the disc in this unit. The letter or number inside the globe refers to region of the world. A BD-video or DVD-video labeled for a specific region can only be played back in the unit with the same region code.

BD-video



DVD-video



For BDP5320/F7
(USA / Canada)



For BDP5320/F8
(Mexico)







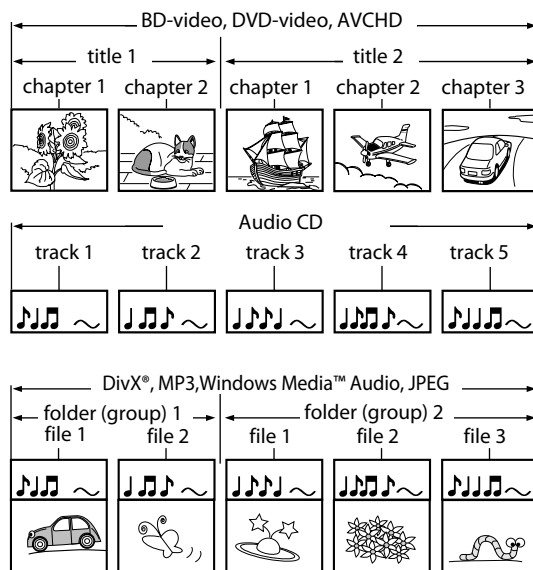

Hint for Disc Playback

The contents of disc are generally divided into sections or folders (groups of titles / files) as shown below.



Description for Icons

- [] : group (folder) icon
- [] : group (folder) return icon
- [] : video file icon
- [] : music file icon
- [] : information icon
- [] : key icon
- [] : signal icon
- "Folders" refers to the groups of files.
- "Tracks" refers to the contents recorded on the audio CD.
- "Files" refers to the contents on a disc which are recorded in DivX®, MP3, Windows Media™ Audio, JPEG file format.

Note

- Unrecognizable characters will be replaced by "□".
- For BD, DVD and SD card, this unit can recognize up to 999 groups (folders), and 9,999 tracks / files.
- For CD, this unit can recognize up to 255 groups (folders), and 999 tracks / files.

Guide to File List

Audio CD Track List

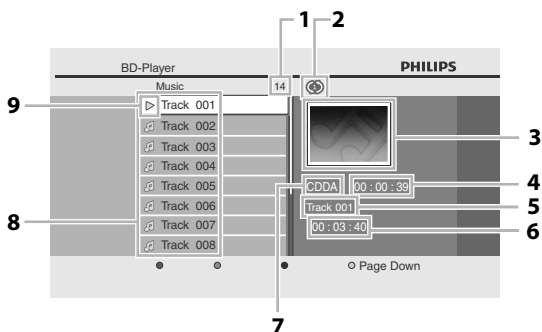

- 1) Total track number
- 2) Repeat status
- 3) Image
- 4) Elapsed playing time of the current track
- 5) Playing track number
- 6) Total time of the current track
- 7) Playing media
- 8) Track list
- 9) Playback status

Video / Music Mode File List

e.g.) MP3 mode

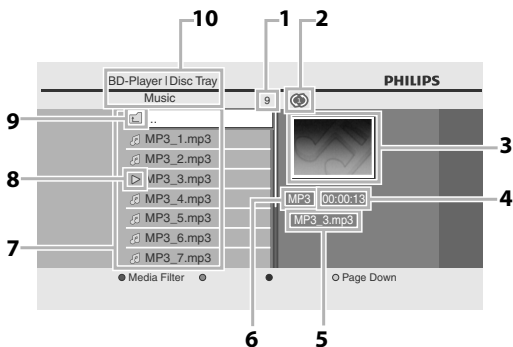

- 1) Number of contents in the current hierarchy
- 2) Repeat status (Music mode only)
- 3) Image
- 4) Elapsed playing time of the current track
- 5) Current file name
- 6) Media type
- 7) Group (folder) / File list
- 8) Playback status
- 9) Root folder
- 10) Directory

Picture Mode File List

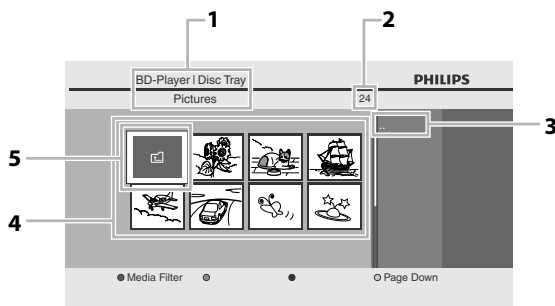

- 1) Directory
- 2) Number of contents in the current hierarchy
- 3) Current file name
- 4) Group (folder) / File list (thumbnails)
- 5) Root folder

How to Insert a Disc

- 1) Press [**▲** (open/close)] to open the disc tray.
- 2) Place the disc on the disc tray with its label side facing up.

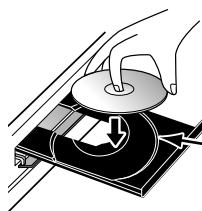

Align the disc to the disc tray guide.

* Make sure the disc is compatible with this unit (refer to page 23 for the list of compatible discs).

- 3) Press [**▲** (open/close)] to close the disc tray.

It may take a while to load the disc.

To eject the disc:

Press [**▲** (open/close)] to open the disc tray.
Remove the disc.
Press [**▲** (open/close)] to close the disc tray.

BASIC PLAYBACK

Playing Back a BD, DVD or a Disc with AVCHD Files

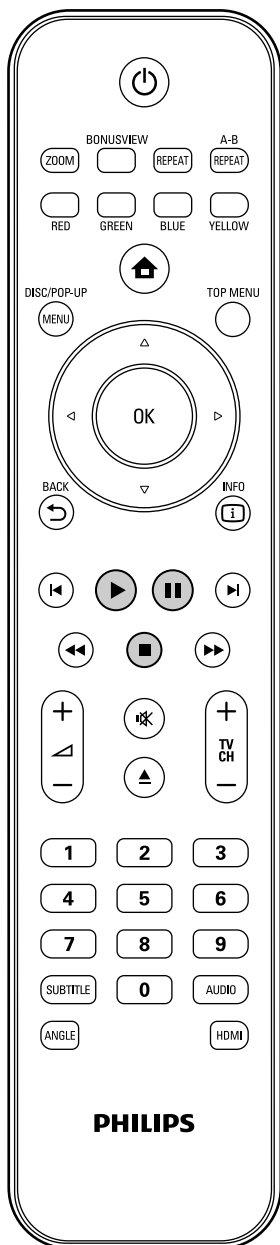

1 Insert a disc (refer to “How to Insert a Disc” on page 25).

2 Playback may start automatically. If not, press **[▶ (play)]**. Some discs may show a title or a disc menu. In this case, refer to “Using the Title / Disc Menu” on page 31.

To pause playback:

Press **[⏸ (pause)]**.

To return to the normal playback:

Press **[▶ (play)]**.

To stop playback:

Press **[■ (stop)]**.

Playback will be in Resume-On-Stop mode, and the home menu will appear.

<Resume-On-Stop mode>

When you press **[▶ (play)]** next time, the playback will start from the point where it has been stopped.

Note

- Playback will also stop and the home menu will appear when you press **[⬆ (home)]**.
- For BD-Java application, the Resume-On-Stop may not be available.
- If you press **[OK]** instead of **[▶ (play)]**, playback can be started from the beginning of the disc even if it was in the Resume-On-Stop mode.
- You can also start from the beginning of the disc if you press **[◀ (previous)]** while the resume message is displayed.
- The resume message can be removed by pressing **[BACK ↶]**.
- Resume-On-Stop mode remains in effect even after power is turned off, but will be cancelled once the disc is ejected.

BASIC PLAYBACK

Playing Back an Audio CD or a Disc with DivX® / MP3 / Windows Media™ Audio / JPEG Files

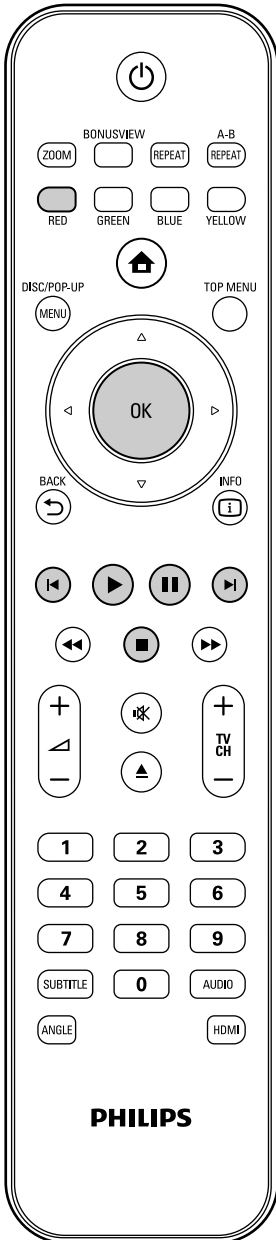

How to Navigate through the Track / File List

- Use [▲ / ▼] to move the highlight up and down in the list.
- To access the files in a group (folder), select the desired group (folder), then press [OK].
- Press [◀], or select [📁], then press [OK] to go back to the previous hierarchy.
- Press [◀] to go back to the previous screen.
- Press [BLUE] or [YELLOW] to change the page of the list.
- Press [RED] to go back to the media filter screen.
- Press [🏠 (home)] to go back to the home menu.

Recommended specifications:

DivX®

Official DivX® Certified product

- Playable codec of AVI files : DivX® 3.x, DivX® 4.x, DivX® 5.x, DivX® 6.x
- Maximum size of a video : 720 x 480 @30 fps
720 x 576 @25 fps
- Sampling frequency of audio : 16 kHz - 48 kHz
- Audio type : MPEG1 audio layer 3(MP3), MPEG1 audio layer 2, Dolby Digital

MP3 / Windows Media™ Audio

- Sampling frequency : 32 kHz, 44.1 kHz or 48 kHz
- Constant bit rate : 112 kbps - 320 kbps (MP3), 48 kbps - 192 kbps (Windows Media™ Audio)

JPEG

Resolution

- Upper limit : 2,560 x 1,900 dots (sub sampling is 4:4:4)
: 5,120 x 3,840 dots (sub sampling is up to 4:2:2)
- Lower limit : 32 x 32 dots
- Maximum file size of a picture : 5 MB

Folder / File number limitations:

BD, DVD and SD card

- 999 folders (groups) and 9,999 files.

CD

- 255 folders (groups) and 999 tracks / files.

EN

Introduction

Connections

Basic Setup

Playback

Function Setup

Others

BASIC PLAYBACK

1 Insert a disc (refer to “How to Insert a Disc” on page 25).

- Home menu appears automatically.

2 With “Disc Tray” selected, press [OK].

- Media filter screen will appear.
- For audio CD, skip to step 4.



3 Select the type of the file you want to play back in the media filter screen. Then press [OK] to display the file list.

- “Video”** : If you want to play back video files such as DivX® video, select “Video”.
- “Music”** : If you want to play back music files such as MP3 or Windows Media™ Audio, select “Music”.
- “Pictures”** : If you want to play back the still images such as JPEG pictures, select “Pictures”.

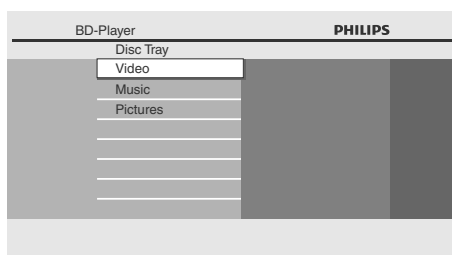

4 Select a group (folder) or track / file you want to play back. Then press [▶ (play)] or [OK] to start playback.

Refer to “How to Navigate through the Track / File List” on page 27.

To skip to the next track / file:

Press [▶] (next).

To skip to the previous track / file:

Press [◀] (previous).

To pause playback:

Press [⏸] (pause).

To return to the normal playback:

Press [▶] (play).

To stop playback:

Press [■] (stop).

Playback will be in Resume-On-Stop mode.

<Resume-On-Stop mode for **audio CD / DivX®** >

Playback will start from the point where it is stopped next time you press [▶] (play).

If you press [OK] instead of [▶] (play), playback will start from the beginning of the track / file instead of resuming from the stop point.

<Resume-On-Stop mode for **MP3 / Windows Media™ Audio / JPEG**>

Playback will start from the beginning of the current file next time you press [▶] (play) or [OK].

To go back to the media filter screen:

Press [RED] in Resume-On-Stop mode.

Note

- Playback will also stop and the home menu will appear when you press [⏠ (home)].
- If a disc contains AVCHD files, the playback of other files which are in the same disc is not available.
- With regard to the multi-border BD-RE/-R, additionally recorded sections cannot be recognized.
- With regard to the multi-border DVD-RW/-R, additionally recorded sections may not be recognized.

Kodak Picture CD

JPEG

This unit can also run JPEG files stored on Kodak Picture CD. You can enjoy picture images on the TV set by playing back the Kodak Picture CD. This unit conforms to ver.7.0 of Kodak Picture CD. For details of Kodak Picture CD, contact a shop that provides developing service of Kodak Inc.

- 1 Insert a Kodak Picture CD.**
 - Home menu appears automatically.
- 2 With "Disc Tray" selected, press [OK].**
 - Media filter screen will appear.
- 3 Select "Pictures" in the media filter screen. Then press [OK] to display the file list.**
- 4 Follow step 4 in "Playing Back an Audio CD or a Disc with DivX® / MP3 / Windows Media™ Audio / JPEG Files" on pages 27-28.**

Tips for JPEG / Kodak Picture CD Playback

- Every press on [ANGLE] will turn the image clockwise by 90 degrees when an image is displayed.

Note

- Some unplayable folders or files may be listed due to the recording status.
- High-resolution JPEG files take longer to be displayed.
- Progressive JPEG files (JPEG files saved in progressive format) cannot be played back in this unit.

Reading the SD Memory Card

AVCHD MP3 WINDOWS MEDIA AUDIO JPEG

You can play back the AVCHD / MP3 / WMA / JPEG files in an SD Memory Card.

With the SD Memory Card, you can also enjoy the following functions.

- Special additional contents for BD-ROM Profile 1 ver.1.1. (For more information about the special additional contents, refer to the instruction book that came with the disc.)
- BD-Live function (BD-ROM ver. 2 Profile 2.0). (For more information about BD-Live, refer to page 34.)

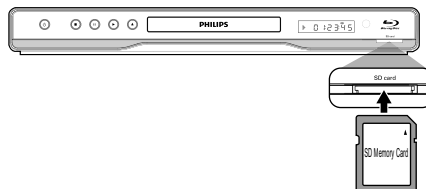

- 1 Insert an SD card and then press [⬆ (home)].**
 - Home menu appears.
- 2 With "SD Card" selected, press [OK].**
 - Media filter screen will appear.
- 3 Select the type of the file you want to play back in the media filter screen. Then press [OK] to display the file list.**

Playback of AVCHD files will start right after you choose "Video". (The file list is not available for AVCHD files.)
- 4 Follow step 4 in "Playing Back an Audio CD or a Disc with DivX® / MP3 / Windows Media™ Audio / JPEG Files" on pages 27-28.**

To remove the SD Memory Card:

In stop mode, gently push in the SD Memory Card, then pull it out slowly.

BASIC PLAYBACK

Note

- In the "SD Card" mode, the resume information will be cleared when;
 - [■ (stop)] is pressed while in the Resume-On-Stop mode.
 - the SD Memory Card is removed.
 - the unit is turned into the standby mode.
- Do not remove the SD Memory Card or turn the unit to the standby mode while the contents of the card are in playback. It may result in malfunction or loss of the card's data.
- Do not delete the folders or files in the SD Memory Card with your computer. This unit may not read SD Memory Cards formatted on a computer.
- If a folder or file name includes one of the following unrecognizable characters, the folder or file name may not be displayed correctly.
 - Unrecognizable characters : ., " = + [] ; / \ : | ¥

About DivX® and DivX® VOD

DivX

Useful tips for purchased or rented official DivX® Certified Videos

- When you purchase or rent a DivX® file through the official site of DivX® video which is called DivX® Video On-Demand (VOD) services, a registration code is required every time you get the new file from the DivX® VOD services. Refer to "DivX® VOD" in "LIST OF SETTINGS" on page 46.

Possible Errors

"This rental has 0 views left. Do you want to use one of your 0 views now?"

Some DivX® VOD files are restricted with limited playable times. You cannot play them back beyond the limit.

"This player is not authorized to play this video."

You cannot play back DivX® VOD files obtained with different registration codes on this unit.

"This rental is expired."

You cannot play back DivX® VOD files with the expired rental period.

"This player does not support this video format."

You cannot play back DivX® files whose resolution exceeds 720 x 576.

"This player does not support this audio format."

For DivX® files with audio format other than MPEG1 audio layer 3 (MP3), MPEG1 audio layer 2 and Dolby Digital, audio will not be output and only the video will be output.

"This player does not support this video frame rate."

You cannot play back DivX® files whose frame rate exceeds 30 fps.

Note

- A file with an extension of ".avi" and ".DivX" is called as a DivX® file. All files with the ".avi" extension are recognized as MPEG4.
- For CD-RW/-R, maximum of 255 group (folder) or 999 files may be recognized.
- For BD-RE/-R and DVD-RW/-R, maximum of 999 group (folder) or 9,999 files may be recognized.
- The 10th and deeper hierarchies cannot be displayed.
- Unrecognizable characters will be replaced with "□".
- When playing back files recorded in high bit rates, images can be interrupted in some occasions.
- Although DivX® logo has been obtained for this unit, it may not be able to play back some data, depending on the characteristics, bit rates, or audio format settings, etc.
- If a large-sized DivX® file is selected, it may take a while to start the playback (over 20 seconds sometimes).
- If DivX® files written on a CD-RW/-R cannot be played back, rewrite them on a BD-RE/-R or DVD-RW/-R, and try playing them back again.
- For more information about DivX®, please visit <http://www.divx.com>.

Playing Back DivX® with DivX® External Subtitle

DivX®

Subtitles created by the user can be displayed during DivX® playback.

1) Follow steps 1 to 3 in “Playing Back an Audio CD or a Disc with DivX® / MP3 / Windows Media™ Audio / JPEG Files” on pages 27-28.

2) Select a file you want to play back, then press [GREEN].

Subtitle list will appear.

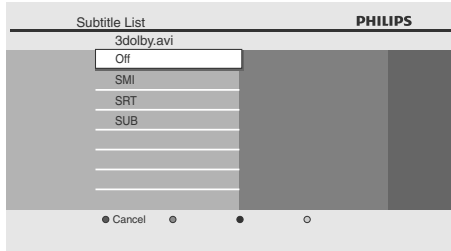

- “DivX Subtitle” appears next to “Green” icon only when DivX® subtitle is available for the selected file.
- If you press [▶ (play)] or [OK] instead of [GREEN], playback without subtitle will start.

3) Select the desired subtitle file, then press [▶ (play)] or [OK].

Playback of the DivX® file with DivX® subtitle will start.

Note

- To utilize this function, the following conditions must be met:
 - Playback file and subtitle file must have the same name.
 - Playback file and subtitle file must be located in the same folder.
 - Only subtitle files with the following extensions are supported; .smi (.SMI), .srt (.SRT), .sub (.SUB), .ass (.ASS), .ssa (.SSA), .txt (.TXT). (.sub (.SUB) and .txt (.TXT) may not be recognized.)
 - Subtitles that exceeds the playback time of the DivX® file will not be displayed.
- If the DivX® subtitle file contains more than one subtitle language, you can toggle those by pressing [SUBTITLE] repeatedly.

Using the Title / Disc Menu



Some BD-video, DVD-video or AVCHD files may contain a title menu which describes the contents of the disc, or a disc menu which guides you through the available functions in the disc.

With such discs, a title menu or a disc menu may appear automatically when you insert the disc. Otherwise, press [TOP MENU] or [DISC MENU / POP-UP MENU] to call up the menu. Refer to the disc’s manual on how to navigate through the menu.

Note

- Menu vary among discs. Refer to the information accompanying the disc for details.
- [TOP MENU] or [DISC MENU / POP-UP MENU] may not work with some discs.
- Title menu is also available for SD card with AVCHD files.

SPECIAL PLAYBACK

Fast Forward / Fast Reverse



- 1) During playback, press [▶▶ (forward)] repeatedly for fast forward.

During playback, press [◀◀ (reverse)] repeatedly for fast reverse.

Every time you press [▶▶ (forward)] or [◀◀ (reverse)], the playback speed will change.

- 2) Press [▶ (play)] to return to the normal playback.

Note

- For BD, DVD and AVCHD, speed changes in 5 different levels.
- For audio CD, DivX®, MP3 and Windows Media™ Audio, speed changes in 3 different levels.
- For some DivX® files, fast forward / fast reverse may not function.

Slow Forward Playback



- 1) During playback, press [|| (pause)]. Then press [▶▶ (forward)].

Every time you press [▶▶ (forward)], the playback speed changes in 3 different levels.

- 2) Press [▶ (play)] to return to the normal playback.

Note

- Only slow forward is available.
- For some DivX® files, slow forward may not function.

Step by Step Playback



- 1) In pause mode, press [|| (pause)] repeatedly.

Every time you press [|| (pause)], playback will advance one step at a time.

- 2) Press [▶ (play)] to return to the normal playback.

Note

- Only step by step forward is available.

Zoom



During playback, you can zoom up the picture.

- 1) During playback, press [ZOOM] repeatedly.

Every time you press [ZOOM], zoom factor will change.

e.g.) DVD-video

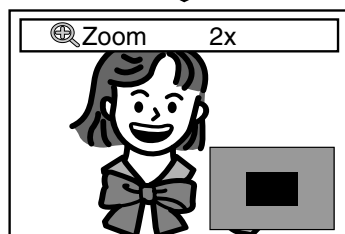
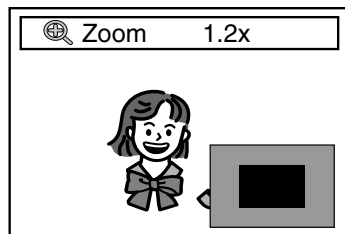

- 2) You can move over the zoomed picture using [▲ / ▼ / ◀ / ▶].

The gray box with an inner blue box displayed at the right bottom corner of the zoomed image is the position guide. The inner blue box indicates the zoomed area. (Not available for the JPEG playback.)

- 3) Press [ZOOM] repeatedly to return to the normal playback.

Note

- For JPEG files, slide show of the zoomed picture is not possible.
- For some DivX® files, zoom may not be available.
- For DivX® and JPEG files, 4x zoom is not available.
- For some DVDs, 4x zoom is not available.
- [ZOOM] does not work during the playback of the BD-video.
- [ZOOM] does not work while DVD menu is displayed.
- For JPEG files, when changing the zoom factor or moving the zoom position, the screen may become black for a moment. This is not a malfunction.

Repeat Playback

Available repeat function varies depending on the discs.

- 1) **During playback, press [REPEAT] repeatedly to select the desired repeat function.**

REPEAT MODE	AVAILABLE MEDIA
Chapter Repeat	BD-video / DVD-video / AVCHD
The current chapter will be played back repeatedly.	
Title Repeat	BD-video / DVD-video / AVCHD
The current title will be played back repeatedly.	
Track Repeat	Audio CD / DTS-CD / DivX® / MP3 / Windows Media™ Audio
The current track or file will be played back repeatedly.	
All Repeat	Audio CD / DTS-CD
All tracks in the media will be played back repeatedly.	
Group Repeat	DivX® / MP3 / Windows Media™ Audio / JPEG
The current group (folder) will be played back repeatedly.	
Random Repeat (Audio CD)	Audio CD / DTS-CD
Repeats the random playback.	
Random Repeat (DivX® / MP3 / Windows Media™ Audio / JPEG)	DivX® / MP3 / Windows Media™ Audio / JPEG
Repeats the random playback in a folder.	

Note

- The repeat setting will be cancelled when you stop playback.
- If you press [REPEAT A-B] when the repeat setting for BD, DVD, CD, AVCHD or DivX® file is set, the repeat setting will be cancelled.
- When the repeat setting is set for a MP3 or WMA folder (file), the repeat setting will be cancelled if you select other MP3 or WMA folder (file) to playback.

A-B Repeat



You can play back the specific part (between point A and point B) repeatedly.

- 1) **During playback, press [REPEAT A-B] once at the point where you want to set point A.**
- 2) **During playback, press [REPEAT A-B] again at the point where you want to set point B.**

As soon as you set point B, the part between point A and point B will start to play repeatedly.

To cancel A-B repeat:

Press [REPEAT A-B] repeatedly until "Off" appears.

Note

- Point B should be set within the same title or track as point A.
- If you press [REPEAT A-B] when the repeat setting for BD, DVD, CD, AVCHD or DivX® file is set, the repeat setting will be cancelled.
- For some DivX® files, A-B repeat playback may not function.
- To cancel the A point which was set, press [CLEAR].

Slide Show

JPEG

- 1) **Follow steps 1 to 3 in "Playing Back an Audio CD or a Disc with DivX® / MP3 / Windows Media™ Audio / JPEG Files" on pages 27-28.**

- 2) **Open the folder which contains the desired JPEG files.**

- 3) **Use [▲ / ▼ / ◀ / ▶] to select a desired file to be played back, then press [▶ (play)] or [OK].**

- An image will be played back from the selected file and go to the next one in turn every 10 seconds.

- 4) **Press [■ (stop)] to stop playback.**

To return to the first item:

Press [TOP MENU].

To return to the file played last:

Press [DISC MENU / POP-UP MENU].

Note

- Large-size JPEG files take a few moments to be displayed.

PiP (BONUSVIEW) Setting



Some BD-videos have the PiP function which enables you to display the secondary video in the primary video. You can call up the secondary video by pressing [BONUSVIEW (PiP)] whenever the scene contains the secondary video.

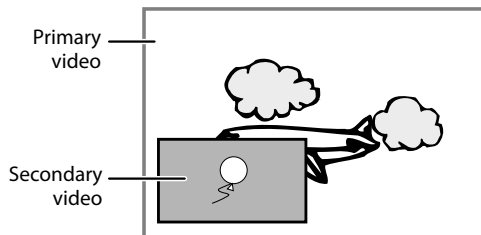

- 1) **During playback, press [BONUSVIEW (PiP)].**

PiP information will appear.

- 2) **Use [▲ / ▼] to select the secondary video you want to show.**

- The secondary video will be displayed with the secondary audio.
- Use [◀ / ▶] to switch between current setting and "Off".

- 3) **Press [BACK ↵] to remove the PiP information.**

- On how to output the secondary audio, refer to "Switching Audio Soundtrack" on page 36 and "Blu-ray Disc Audio" on page 44.

SPECIAL PLAYBACK

Enjoying BD-Live Discs with Internet



You can enjoy BD-Live which enables you to use interactive features when the unit is connected to the Internet.

Examples of BD-Live features:

- Online access to additional content such as movie trailers, subtitles, BD-Java applications, etc.
- While downloading, special video data may be played back.
 - **Service and functions differ depending on the disc. Follow the instructions given by the disc when using the BD-Live function.**
 - **You must insert an SD Memory Card when using the BD-Live function. (SD Memory Card of 1GB or more is recommended.)**
 - **Do not remove the SD Memory Card when using the BD-Live function.**

Note

- You must connect the unit to the Internet and set up necessary settings in order to use BD-Live.
- For the network connection, refer to "Connection to the Network" on page 20.
- For the network setup, refer to "Network Connection" on page 53.
- For certain discs, "BD-Live Setting" may need to be changed.
- Depending on your connection environment, it may take time to connect to the Internet or the Internet may not be connected.
- When BD-Live functions are used and the unit is connected to the Internet, you may be charged for this communication.
- Some discs with BD-Live function require memory when playing back the content. If you cannot play back a disc with BD-Live function, insert an SD card(1GB or more) which is formatted on this unit.

Note for AACs Online

- The player or disc IDs may be sent to the content provider when playing back a disc with BD-Live function.
- If you save your viewing history on the server by using these IDs, you will be introduced to other similar movies.
- You can save game score histories.

Title / Chapter Search



Using [◀ (previous)] / [▶ (next)]

- 1) **During playback, press [▶ (next)] to skip the current title or chapter and move to the next.**
The title or chapter will move forward by one at a time.
 - If there is no chapter in one title, the current title may be skipped.
To go back to the beginning of the current title or chapter, press [◀ (previous)].
Press [◀ (previous)] repeatedly to go to the previous title or chapter. The title or chapter may move backward one at a time.

Using [INFO ⓘ]

- 1) **During playback, press [INFO ⓘ].**

Disc	
Title	001/012
Chapter	001/023
Playing Time	00:01:31
Audio	Dolby Digital

- 2) **Use [▲ / ▼] to select "Title" or "Chapter".**
- 3) **Use [the Number buttons] or [◀ / ▶] to enter the title / chapter number.**
- 4) **Press [OK].**
Playback will start from the beginning of the title / chapter.
- 5) **Press [INFO ⓘ] to remove the information display.**

Using [the Number buttons] (Direct Search)

Title Search

In stop mode, enter the title number you want to search using [the Number buttons].

Playback of the title will start in a few seconds.

Chapter Search

During playback of a title, enter the chapter number you want to search using [the Number buttons].

Playback of the chapter will start in a few seconds.

Note

- As for the BD-video, how it performs will be strongly determined by the disc, and may not perform as described.

Track Search



Using [◀ (previous)] / [▶ (next)]

- 1) During playback, press [▶ (next)] to skip the current track or file and move to the next.

The track / file will move forward one at a time. To go back to the beginning of the current track / file press [◀ (previous)].

Press it repeatedly to go to the previous track / file. The track / file will move backward one at a time.

Time Search



- 1) During playback, press [INFO ⓘ].

- For DivX® files, skip to step 3).

Disc	
Title	001/012
Chapter	001/023
Playing Time	00:01:31
Audio	Dolby Digital

- 2) Use [▲ / ▼] to select "Playing Time".

- 3) Use [the Number buttons] to enter the time count you want to jump to.

e.g.)

Entering 1 hour 45 minutes and 15 seconds.

Press 1 4 5 1 5

- 4) Press [OK].

Playback will start from the desired time count.

- 5) Press [INFO ⓘ] to remove the information display.

Note

- For some DivX® files, time search may not function.

Switching Subtitles

Some BD and DVD may have subtitles in 1 or more languages. For commercially available discs, the supported languages can be found on the disc case. Follow the steps below to switch the subtitle languages during playback.



- 1) During playback, press [SUBTITLE] repeatedly to display "Primary", "Secondary" or "Subtitle Style".

"Primary" : Sets the subtitle for the primary video.

"Secondary" : Sets the subtitle for the secondary video.

"Subtitle Style" : Sets style of the subtitle.

- 2) Use [▲ / ▼] to select your desired subtitle or style.



- Use [◀ / ▶] to switch between current subtitle setting and "Off".

- 3) Press [SUBTITLE] repeatedly to exit.



- 1) During playback, press [SUBTITLE].

- 2) Use [▲ / ▼] to select your desired subtitle.



- Use [◀ / ▶] to switch between current subtitle setting and "Off".

- 3) Press [SUBTITLE] to exit.

Note

- Some discs will only allow you to change the subtitles from the disc menu or pop-up menu. Press [TOP MENU] or [DISC MENU / POP-UP MENU] to display the disc menu or pop-up menu.
- If the disc has no subtitle language or subtitle style, "Not Available" will be displayed on the TV screen.
- During playback of the secondary video, the primary subtitle setting is not available except when there is no subtitle for the secondary video.
- For DivX® external subtitle, "Playing Back DivX® with DivX® External Subtitle" on page 31.

SPECIAL PLAYBACK

Switching Audio Soundtrack

Some BD and DVD contain multiple audio streams. Those are often in different audio languages or audio formats. For BD, available audio varies depending on “Blu-ray Disc Audio” setting. Refer to page 44 for more information.



1) **During playback, press [AUDIO] repeatedly to display “Primary” or “Secondary”.**

“Primary” : Sets the audio for the primary video.

“Secondary” : Sets the audio for the secondary video.

2) **Use [▲ / ▼] to select your desired audio stream channel.**



- For “Secondary”, use [◀ / ▶] to switch between current audio setting and “Off”.

3) **Press [AUDIO] repeatedly to exit.**



1) **During playback, press [AUDIO].**

2) **Use [▲ / ▼] to select your desired audio stream channel.**



3) **Press [AUDIO] to exit.**

Note

- The secondary audio will not be output when the secondary video is not displayed or when “Blu-ray Disc Audio” is set to “Primary Audio Only”. (For some BD, secondary audio will be output even when secondary video is off.)
- The sound mode cannot be changed during playback of discs not recorded in multiple audio.
- Some discs allow changing the audio language setting on the disc menu. (Operation varies depending on the discs. Refer to the manual accompanying the disc.)
- [AUDIO] may not work on some discs with multiple audio streams or channels (e.g. DVDs that allow changing audio setting on the disc menu).
- If the disc has no audio language, “Not Available” will be displayed on the TV screen.
- For DTS-CD (5.1 music disc), selecting audio streams or channels is not available.
- You can check the selected audio stream in the information display. To call up the information display, press [INFO ⓘ] during playback.

Switching Camera Angles



Some BD-video and DVD-video contain scenes which have been shot simultaneously from various angles. You can change the camera angle when  appears on the TV screen.

1) **During playback, press [ANGLE].**

- The selected angle will be displayed on the display bar at the top of the TV screen.

2) **Use [▲ / ▼] to select your desired angle.**



3) **Press [ANGLE] to exit.**

Note

- If “Angle Icon” setting is set to “Off”,  will not appear on the TV screen. (Refer to page 46)

NETFLIX OPERATIONS

With this unit, you can watch movies and TV episodes streamed instantly from Netflix via the Internet. In order to use this feature, you must visit the following website on your PC and become a Netflix member. netflix.com/Philips

Before Activating the Connection to Netflix

After creating a Netflix account at netflix.com/Philips, follow the following procedure before activating the connection to Netflix.

- 1) **Connect this unit to the Internet.**
 - Refer to "Connection to the Network" on page 20.
- 2) **Set up the necessary network connection settings.**
 - Refer to "Network Connection" on page 53.

Activating the Connection to Netflix

In order to watch movies and TV episodes streamed instantly from Netflix via the Internet, you must activate the connection between this unit and your Netflix account.

- 1) Press [**home**] to access the home menu.
- 2) Use [**▲** / **▼**] to select "NETFLIX", then press [**OK**].
 - Netflix welcome screen will appear.
 - For the first time only, "Network Service Disclaimer" screen will appear. After confirming the content, use [**◀** / **▶**] to select "Agree", then press [**OK**].
- 3) Use [**▲** / **▼**] to select "yes - activate instant streaming from Netflix", then press [**OK**].
 - Activation screen with the activation code will appear.



- 4) **On your PC, visit netflix.com/activate and log into your account.**
 - The entry screen of activation code will appear on your PC screen.
- 5) **Enter the activation code which is displayed on the TV screen.**
 - The instant Queue will appear.
 - The connection to Netflix is successfully made.
 - To browse the instant Queue and watch movies, skip to step 3) in "Watching Streaming Movies" on page 37.

Note

- Netflix is available only in the United States.
- You cannot create a Netflix account on this unit.
- If newer version of software is required, software upgrade screen may appear after selecting "NETFLIX" in step 2). (For software upgrade, refer to "Software Upgrade" on page 58.)
- You can deactivate the connection to Netflix by setting the "Netflix Deactivate" to "Yes". (Refer to page 47.)
- The screen image of Netflix may change after upgrading the firmware.
- For questions regarding the Netflix service, visit netflix.com/Help.
- When you contact the Netflix customer service, you may be asked for the ESN number, which is a serial number to identify this unit by Netflix. You can check the ESN number on the bottom of the "Netflix Deactivate" screen. (Refer to page 47.)

Watching Streaming Movies

After you set up the connection to Netflix, you can browse the instant Queue and watch movies on your TV.

- 1) Press [**home**] to access the home menu.
- 2) Use [**▲** / **▼**] to select "NETFLIX", then press [**OK**].
 - The instant Queue will appear.
- 3) Use [**◀** / **▶**] to select the desired movie or TV episode, then press [**▶** (play)] to start playback.

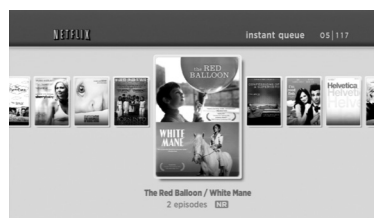

- After loading, playback of the selected movie or TV episode will start.
- To stop the playback, press [**stop**].
- To go back to the instant Queue, press [**RED**].
- To go back to the home menu, press [**home**].

About the Instant Queue

- Instant Queue is the list of movies and TV episodes you add on the Netflix website. (netflix.com) You can manage the movies and TV episodes in your instant Queue from the Netflix website on your PC.
- You cannot add movies or TV episodes to your instant Queue on this unit.
- You can remove movies or TV episodes from the instant Queue on this unit.

Note

- The picture quality differs depending on the speed of your Internet connection at the time of loading.

CINEMANOW / BLOCKBUSTER OPERATIONS

With this unit, you can watch movies and TV episodes streamed instantly from CinemaNow / Blockbuster via the Internet. In order to use this feature, you must visit the following website and create a CinemaNow / Blockbuster account.

- For CinemaNow, visit www.cinemanow.com/Login
- For Blockbuster, visit www.blockbuster.com/auth/login

Before Activating the Connection to CinemaNow / Blockbuster

After creating a CinemaNow / Blockbuster account, follow the following procedure before activating the connection to CinemaNow / Blockbuster.

- 1) Connect this unit to the Internet.**
 - Refer to "Connection to the Network" on page 20.
- 2) Set up the necessary network connection settings.**
 - Refer to "Network Connection" on page 53.

Activating the Connection to CinemaNow / Blockbuster

In order to watch movies and TV episodes streamed instantly from CinemaNow / Blockbuster via the Internet, you must activate the connection between this unit and your CinemaNow / Blockbuster account.

- 1) On your PC, visit following website and log into your account to get the activation code.**
 - Follow the instruction given by the website.
 - Take a note of the activation code which appears on the PC.
- For CinemaNow, visit www.cinemanow.com/activate.
 - For Blockbuster, visit www.blockbuster.com/activate/philipsbd.

- 2) On this unit, press [⬆️ (home)] to access the home menu.**
- 3) Use [▲ / ▼] to select "CinemaNow" or "BLOCKBUSTER", then press [OK].**
 - Menu screen of CinemaNow or Blockbuster will appear.
 - For the first time only, "Network Service Disclaimer" screen will appear. After confirming the content, use [◀ / ▶] to select "Agree", then press [OK].
- 4) Use [▲ / ▼ / ◀ / ▶] to select "Settings" (CinemaNow) or "Configure" (Blockbuster), then press [OK].**
 - For CinemaNow, select "Activate" and press [OK] again in the next screen.
 - Activation code input screen will appear.

e.g.) CinemaNow

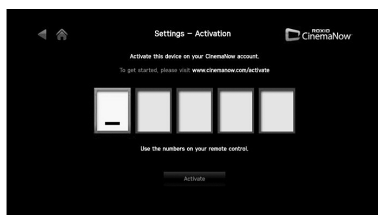

- 5) Enter the activation code displayed on your PC using [◀ / ▶] and [the Number buttons], then select "Activate" and press [OK].**
 - For CinemaNow, confirmation message will appear. Press [OK] to complete the setting.

Note

- The image of menu screen may change without notice after upgrading the firmware or the information on CinemaNow / Blockbuster server is changed.
- You cannot create CinemaNow / Blockbuster account on this unit.
- To deactivate the connection to CinemaNow or Blockbuster, select "Deactivate" in "Settings" (CinemaNow) or "Configure" (Blockbuster).
- For questions regarding CinemaNow service, visit www.cinemanow.com/support.
- For questions regarding Blockbuster service, visit www.blockbuster.com/help.

Guide to CinemaNow / Blockbuster Menu Screen

CinemaNow

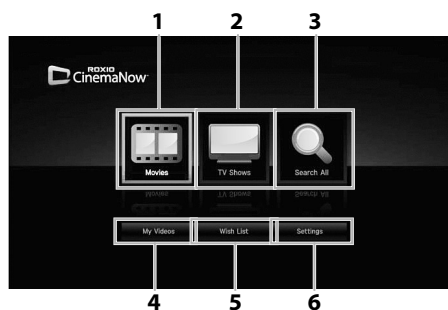

Blockbuster

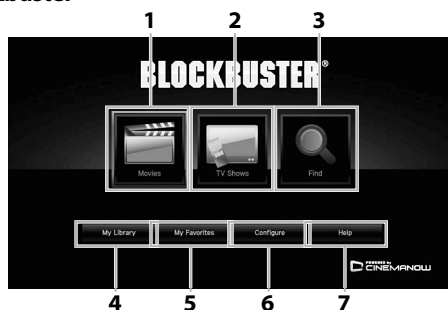

- | | |
|------------------------------------|--|
| 1) Movies | : To access the movie list |
| 2) TV Shows | : To access the TV show list |
| 3) Search All / Find | : To access search screen |
| 4) My Videos / My Library | : To access the list of rented or purchased movies / TV episodes |
| 5) Wish List / My Favorites | : To access your wish list / favorite list |
| 6) Settings / Configure | : To access setting / configure menu |
| 7) Help | : To access the help page |

Renting or Purchasing Movies / TV episodes

After you set up the connection to CinemaNow / Blockbuster, you can rent or purchase movies / TV episodes and watch directly on your TV.

- 1) Press [**⬆** (home)] to access the home menu.
- 2) Use [**▲ / ▼**] to select "CinemaNow" or "BLOCKBUSTER", then press [OK].
- 3) Use [**▲ / ▼ / ◀ / ▶**] to select "Movies" or "TV Shows", then press [OK].
 - List of movies / TV episodes will appear.
- 4) Use [**▲ / ▼ / ◀ / ▶**] to select the desired title, then press [OK].
 - Title details screen of the selected title will appear.
- 5) Use [**◀ / ▶**] to select "Rent" or "Buy", then press [OK].
 - Checkout screen will appear.
- 6) Use [**◀ / ▶**] to select "Submit Order", then press [OK].
- 7) Use [**◀ / ▶**] to select "Watch Now", then press [OK].
 - If you want to continue browsing, select "Continue Browsing" and press [OK] to go back to "Movies".

Note

- If you select "Add to Wish List" (CinemaNow) or "Add to My Favorites" (Blockbuster) in title details screen, the title will be added to your "Wish List" or "My Favorites".
- For CinemaNow, if you want to redeem a gift code, select "Redeem Gift Code" in the checkout screen, then press [OK] and enter the gift code.
- In most cases, rented movies or TV episodes are available for 24 hours from the playback starting time.

Searching Movies / TV episodes

From the search screen, you can search for movies / TV episodes by entering search words.

- 1) Follow steps 1) to 2) in "Renting or Purchasing Movies / TV episodes" on page 39.
- 2) Use [**▲ / ▼**] to select "Search All" (CinemaNow) or "Find" (Blockbuster), then press [OK].
 - Keypad screen will appear.
- 3) Use [**▲ / ▼ / ◀ / ▶**] to select characters, then press [OK].
 - When you enter a letter, titles that start with the letter will be displayed on the right side of the screen.
- 4) Use [**▲ / ▼ / ◀ / ▶**] to select a desired title from the search result on the right side of the screen, then press [OK].
 - Title details screen of the selected title will appear.

Watching Rented or Purchased Movies / TV episodes

- 1) Follow steps 1) to 2) in "Renting or Purchasing Movies / TV episodes" on page 39.
- 2) Use [**▲ / ▼ / ◀ / ▶**] to select "My Videos" (CinemaNow) or "My Library" (Blockbuster), then press [OK].
 - List of rented or purchased movies / TV episodes will appear.
- 3) Use [**▲ / ▼ / ◀ / ▶**] to select a desired title, then press [OK].
- 4) Use [**◀ / ▶**] to select "Watch from Start" (CinemaNow) or "Play Now" (Blockbuster), then press [OK].
 - If you want to resume playback, select "Resume Play" and press [OK].
 - To stop the playback, press [**■** (stop)].
 - To pause the playback, press [**⏸** (pause)].
 - To go back to the home menu, press [**⬆** (home)].

Note

- Depending on your network environment and speed, the playback may be paused or stopped. To improve playback condition, use high speed broadband Internet connection (For details, contact your Internet service provider.)

ENJOYING INTERNET RADIO WITH vTuner

With this unit, you can enjoy Internet radio with vTuner via the Internet.
In order to listen to Internet radio, you must connect this unit to the Internet.

For the network connection, refer to “Connection to the Network” on page 20.

For the network setup, refer to “Network Connection” on page 53.

Internet Radio Playback

After you set up the network connection, follow the following procedure to listen to Internet radio.

- 1) Press [**home**] to access the home menu.
- 2) Use [**▲ / ▼**] to select “vTuner”, then press [OK].
 - Category list will appear.
 - For the first time only, “Network Service Disclaimer” screen will appear. After confirming the content, use [**◀ / ▶**] to select “Agree”, then press [OK].
- 3) In the category list, use [**▲ / ▼**] to select the desired category, then press [OK].

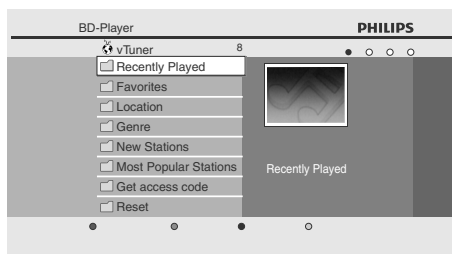

- Station / folder list of selected category will appear.
- For “Location” and “Genre”, use [**▲ / ▼**] to select the desired location or genre after selecting the category, then press [OK].

“Recently Played”	: List of stations which are recently played
“Favorites”	: List of your favorite radio stations
“My Added Stations”	: List of stations which are added on vTuner website (This category will appear only after you add stations on vTuner website.)
“Location”	: List of stations categorized by location
“Genre”	: List of stations categorized by genre
“New Stations”	: List of new stations
“Most Popular Stations”	: List of popular stations
“Get access code”	: Displays the access code, which will be required when creating a vTuner account on your PC
“Reset”	: Removes all stations / folders in “Recently Played”, “Favorites” and “My Added Stations”

- 4) In the station / folder list, use [**▲ / ▼**] to select the desired station, then press [OK].
 - After loading, playback of the selected station will start.
 - If you select a folder, use [**▲ / ▼**] to select the desired station in the next hierarchy, then press [OK].
 - To stop playback, press [**stop**].
 - To go back to the previous or next hierarchy, press [**◀**] or [**▶**].
 - To start playback of the previous / next station in the list during playback, press [**◀ (previous)**] or [**▶ (next)**].

e.g.) Location

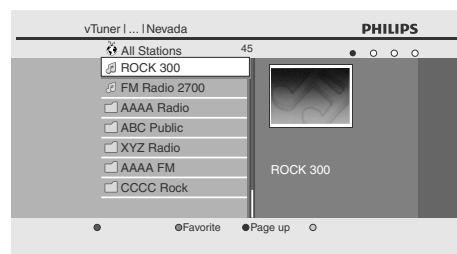

- 5) Press [TOP MENU] to return to the category list or press [**home**] to exit.

Note

- This unit cannot play back stations with audio format other than MP3 and WMA.
- For some stations, playback is not available even if the audio format is displayed as MP3 or WMA.
- Internet radio service may not be fully available with narrowband Internet connection. (e.g. 56k modem) When listening to Internet radio, use broadband Internet connection. (For details, contact your Internet service provider.)
- Depending on the bit rate of a station or the network environment, it may take a while to complete loading the station or playback may not be available.
- Streaming audio may be interrupted during playback, when the vTuner server is busy.
- Some stations cannot be displayed in the list, depending on the network environment.
- If the loading time of a station exceeds 3 minutes, loading will be canceled.
- The order of station / folder in the list depends on the information from vTuner server and may change without notice.

Guide to the Playback Screen

e.g.) Location

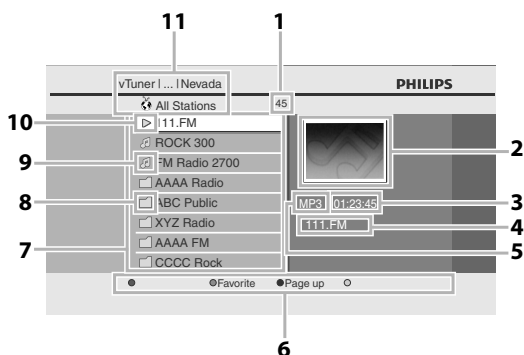

- 1) Number of stations / folders in the current hierarchy
- 2) Image
- 3) Elapsed playing time of the current station
- 4) Current station / folder name
- 5) Audio format of the current station
- 6) Color key (RED / GREEN / BLUE / YELLOW button) guide
- 7) Station / folder list
- 8) Folder icon
- 9) Station icon
- 10) Playback status
- 11) Directory

Add to Favorite List

You can add your favorite stations to "Favorites" in the category list. To add your favorite stations, follow the following procedure.

- 1) Follow steps 1) to 3) in "Internet Radio Playback" on page 40.
- 2) Use [▲ / ▼] to select the station you want to add to "Favorites", then press [GREEN].
 - The selected station is added to "Favorites" folder.
 - Confirmation message will appear.
 - If you select a folder, use [▲ / ▼] to select the desired station in the next hierarchy, then press [GREEN].
- 3) Press [OK].

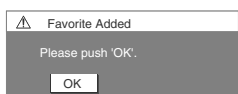

- 4) Press [TOP MENU] to return to the category list or press [▲ (home)] to exit.

Note

- You can also add your favorite stations to "Favorites" on your PC. To add your favorite stations on your PC, visit <http://go2service.vtuner.com/ph/> and create a vTuner account with the access code, which you can check from the category list. (Refer to page 40.)
- You can change folder names or order of lists in your vTuner page on the Internet.
- "My Favorites" folder will appear after you add a station to "Favorites" on this unit. (Your favorite station will also be added to "My Favorites" folder.)

Remove from Favorite List

- 1) Follow steps 1) to 2) in "Internet Radio Playback" on page 40.
- 2) Use [▲ / ▼] to select "Favorites", then press [OK].
- 3) Use [▲ / ▼] to select the station you want to remove from "Favorites", then press [GREEN].
 - Confirmation message will appear.
- 4) Use [◀ / ▶] to select "Yes", then press [OK].
 - The selected station is removed from "Favorites" folder.

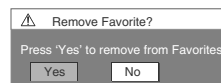

- 5) Press [TOP MENU] to return to the category list or press [▲ (home)] to exit.

Add Stations on the vTuner Website

On the vTuner website, you can add stations which are not in the vTuner station list.

To add stations, you must visit <http://go2service.vtuner.com/ph/> and create a vTuner account with the access code for this unit.

- 1) Follow steps 1) to 2) in "Internet Radio Playback" on page 40.
- 2) Use [▲ / ▼] to select "Get access code", then press [OK].
 - The access code for this unit will be displayed. Please take a note of the access code. (This access code will be required when creating a vTuner account.)
- 3) On your PC, visit <http://go2service.vtuner.com/ph/> and create your vTuner account.
 - Follow the instructions given by the PC screen.
- 4) Add stations by following the instructions given by the PC screen.
 - The stations will be added to "My Added Stations".

Reset the Station List

You can remove all stations / folders in "Recently Played", "Favorites" and "My Added Stations".







- 1) Follow steps 1) to 2) in "Internet Radio Playback" on page 40.
- 2) Use [▲ / ▼] to select "Reset", then press [OK].
- 3) Use [▲ / ▼] to select "Yes", then press [OK].
 - All stations / folders in "Recently Played", "Favorites" and "My Added Stations" are removed.
- 4) Press [TOP MENU] to return to the category list or press [▲ (home)] to exit.

LIST OF SETTINGS

In the settings menu, you can customize the various kinds of settings as you prefer. Refer to the following instruction to navigate through the settings menus.

- 1) Press [**▲** (home)] to access the home menu.
- 2) Use [**▲** / **▼**] to select "Settings", then press [OK].
- 3) Use [**▲** / **▼**] to select the desired setting, then press [OK].
- 4) Use [**▲** / **▼**] to move the highlight up and down in the list.
 - Options of the highlighted item will be displayed in the list on the right whenever available.
- 5) To make a selection or to access options of an item, select the desired item, then press [OK].
 - To go back to the previous screen, press [BACK **↶**].
- 6) Press [**▲** (home)] to exit.

Refer to the following table for the types of settings you can customize. Settings with (*) can be accessed from the "Quick Setup" also. The item highlighted in gray is the default setting.

Category	Menus / Options		Description	
Advanced Setup	Language	Audio   AVCHD	Default Čeština Dansk Deutsch English Español Ελληνικά Français Italiano Magyar Nederlands Norsk Polski Português Русский suomi Svenska Türkçe	Sets the audio language for BD-video, DVD-video or AVCHD playback. <ul style="list-style-type: none"> • If you select "Default", the disc's original language will be in effect.
		Subtitle   AVCHD	Off Čeština Dansk Deutsch English Español Ελληνικά Français Italiano Magyar Nederlands Norsk Polski Português Русский suomi Svenska Türkçe	Sets the subtitle language for BD-video, DVD-video or AVCHD playback.
		Disc Menu   AVCHD	Čeština Dansk Deutsch English Español Ελληνικά Français Italiano Magyar Nederlands Norsk Polski Português Русский suomi Svenska Türkçe	Sets the language for disc menu.
		Player Menu*	Auto (XXXX) English Español Français	Sets the language for player menu (OSD menu) "Auto" : Activates the Get & Set Menu Language function. Refer to page 57. <ul style="list-style-type: none"> • "Auto" is available only when "EasyLink (HDMI CEC)" is set to "On". • Inside the parenthesis next to "Auto" will be the current selected language.
	Video Output	TV Shape* • Refer to page 48 for more information.	4:3 Normal 4:3 Crop 16:9 Widescreen 16:9 Squeeze	Sets the aspect ratio of the playback image to fit your TV.

LIST OF SETTINGS

Category	Menus / Options		Description	
Advanced Setup	Video Output	HDMI 1080p/24  <ul style="list-style-type: none"> This feature is available only when the display device is connected by an HDMI cable. Refer to page 48 for more information. 	Auto Off	"Auto" : Outputs the picture in 1080p/24 (1080 progressive with 24 frames per second) when it meets all the conditions listed below: <ul style="list-style-type: none"> The video resolution and the frame rate of the material is 1080p/24. "HDMI Video Resolution" setting is set to "1080p". The display device supports the 1080p/24 output. "Off" : <ul style="list-style-type: none"> Outputs the picture in 1080p/60. (60 frames per second, progressive)
		HDMI Video Resolution* <ul style="list-style-type: none"> This feature is available only when the display device is connected by an HDMI cable. Refer to page 48 for more information. 	Auto 480p 720p 1080i 1080p	Sets the resolution of the video signal being output from the HDMI OUT jack. <ul style="list-style-type: none"> The selected resolution must also be supported by your TV monitor.
		HDMI Deep Color <ul style="list-style-type: none"> This feature is available only when the display device is connected by an HDMI cable, and when it supports Deep Color feature. 	Auto Off	Reduces the posterization effect of the playback picture. "Auto" : Reduces the posterization effect by automatically outputting up to 36 bit color whenever the unit recognizes the connected display device supports Deep Color feature. "Off" : Outputs the standard 24 bit color.
	Component Output	480i 480p		Sets resolution for component output picture. <ul style="list-style-type: none"> The selected resolution must also be supported by your TV monitor. Refer also to your TV's manual. If you have selected the resolution not supported by your TV by mistake and the picture gets disturbed, press and hold [▶ (play)] on the front panel for 5 seconds to change the setting back to its default. When HDMI cable is connected, only "480i" and the resolution selected in the "HDMI Video Resolution" will be available.
		720p 1080i	With regard to DVD-video with copy protection, the resolution will be set to 480p regardless of the setting here. If 480p output is not available, 480i will be output.	
	De-interlacing Mode	Auto Video		"Auto" : Automatically detects film or video content, and appropriately converts it. "Video" : Select this option when the picture is distorted when using "Auto".
	Black Level	On Off		Adjusts brightness to compensate for ambient room light.
	HD Noise Reduction	On		Reduces noise of the playback picture. "On" : Activates Noise Reduction. "Off" : Deactivates Noise Reduction.
		Off		

EN

Introduction

Connections









Basic Setup

Playback

Function Setup

Others

LIST OF SETTINGS

Category	Menus / Options		Description
Advanced Setup	Night Mode	Auto On Off	Compresses range between soft and loud sounds. "Auto" : Night Mode will be activated automatically when Dolby TrueHD audio is played back. "On" : Activates the Night Mode. "Off" : Deactivates the Night Mode.
	Down Sampling	On Off	Sets the sampling rate for outputting PCM audio from the digital output (coaxial). "On" : Over 96 kHz PCM audio will be down sampled at 48 kHz. "Off" : For BD or DVD recorded in LPCM without copyright protection, 2-channel audio signals up to 96 kHz are output as LPCM signals.
	Virtual Surround       	On Off	Select "On" to enjoy stereophonic virtual space through your existing 2 channel stereo system during playback of BD-video or DVD-video.
	Blu-ray Disc Audio 	Mix Audio Output Primary Audio Only	"Mix Audio Output" : The audio for the secondary video and the interactive application will be output together with the audio for the primary video. "Primary Audio Only" : Only audio for the primary video will be output. When playing back a BD-video which only contains primary audio, the audio output will be the same case as "Primary Audio Only" even if the "Blu-ray Disc Audio" is set to "Mix Audio Output".
	HDMI Audio • This feature is available only when the display device is connected by an HDMI cable. • Refer to page 49 for more information.	HDMI Normal PCM Off	Sets the audio format for sound output from the HDMI OUT jack.
	Digital Out • When HDMI cable is connected, make sure "HDMI Audio" setting is set to "Off" to change the "Digital Out" setting. • Refer to page 51 for more information.	Bitstream PCM	Sets the audio format for the sound output from the DIGITAL OUT (COAXIAL) jack.

LIST OF SETTINGS

Category	Menus / Options			Description		
Ratings Lock • Refer to page 52 for more information.	Rating Level	All		Sets the rating level for the disc playback.		
	New PIN	8 [Adult] to 1 [Kid Safe]		Sets the new password for the "Ratings Lock" setting.		
Network Connection • Refer to pages 53-57 for more information.	Connection Test			Perform a network connection test. After you change IP address or DNS setting, always perform this test.		
	Network Selection	Enable (Wired)	Standard		If you select "Standard", connection test will automatically start.	
			Manual	IP Address Setting	Auto(DHCP)	Set the IP address. In most cases, you can connect to the Internet without making any changes to the default setting.
					Manual	
					Subnet Mask	
					Default Gateway	
				DNS Setting	Auto(DHCP)	Set the DNS setting. In most cases, you can connect to the Internet without making any changes to the default setting.
					Manual	
						Secondary DNS
			Proxy Setting	Do Not Use	Set the proxy server. In most cases, you can connect to the Internet without using proxy server.	
				Use		Proxy Address
					Proxy Port	
			Connection Speed	Auto	Set the connection speed. In most cases, you can connect to the Internet without making any changes to the default setting.	
				10BASE Half		
				10BASE Full		
		100BASE Half				
		100BASE Full				
	BD-Live Setting	Allow	You can restrict Internet access when BD-Live functions are used.			
		Limited Allow				
		Prohibit				
	Network Status		You can check the current status of the network setting.			
	Enable (Wireless)	Wireless Router	Find wireless network	WEP/WPA Authentication	Set up the connection to the wireless router and enter the WEP/WPA key required for wireless network connection.	
			Manually enter your SSID			
			Wireless Router Status		You can check the current status of the wireless router setting.	
	Advanced Settings	Wireless Router	Standard		If you select "Standard", connection test will automatically start.	
			Manual	IP Address Setting		Set the IP address. In most cases, you can connect to the Internet without making any changes to the default setting.
				DNS Setting		Set the DNS setting. In most cases, you can connect to the Internet without making any changes to the default setting.
				Proxy Setting		Set the proxy server. In most cases, you can connect to the Internet without using proxy server.
				BD-Live Setting		You can restrict Internet access when BD-Live functions are used.
		Network Status		You can check the current status of the network setting.		
	Disable	Yes			Deactivate the network connection.	
		No				
Disclaimer					Displays the network service disclaimer.	

LIST OF SETTINGS

Category	Menus / Options		Description
Others	Angle Icon	On <input checked="" type="checkbox"/>	<p>"On": The angle icon automatically appears on the TV screen when playing back content with various camera angles available.</p> <p>"Off": The angle icon does not automatically appear on the TV screen when playing back content with various camera angles available.</p>
		Off <input type="checkbox"/>	
	Front Panel Brightness	Bright	Sets the brightness of the front panel display.
		Dim	
	Screen Saver	Auto <input checked="" type="checkbox"/>	When "Auto" is selected, the front panel display automatically goes dim during playback.
		Off <input type="checkbox"/>	
	Slide Show Transition <input checked="" type="checkbox"/> JPEG	Cut In/Out <input checked="" type="checkbox"/>	Sets the visual effect for the slide show transition mode.
Fade In/Out <input type="checkbox"/>			
DivX® VOD <input checked="" type="checkbox"/> DivX	Registration Code	Your registration code is : ○○○○○○○○○○ To learn more visit www.divx.com/vod	This menu item provides you with the DivX® VOD registration code. The DivX® registration code is required when downloading DivX® VOD files from the Internet. To learn more about DivX® VOD, visit www.divx.com/vod .
	Deactivation Code	Your deactivation code is : ○○○○○○○○○○ To learn more visit www.divx.com/vod	
	Deactivation	Yes <input type="checkbox"/> No <input checked="" type="checkbox"/>	
EasyLink (HDMI CEC) • This feature is available only when the display device is connected with an HDMI cable, and when it supports EasyLink (HDMI CEC) feature. • Refer to page 57 for more information.	On <input checked="" type="checkbox"/>	Off <input type="checkbox"/>	Sets whether to utilize the EasyLink (HDMI CEC) function. EasyLink (HDMI CEC) function allows your PHILIPS brand EasyLink TV to act in conjunction with this unit or vice versa.

LIST OF SETTINGS

	Category	Menus / Options		Description	
Advanced Setup	Others	Software Upgrade • Refer to page 58 for more information.	Disc Upgrade	Yes No	Set the disc upgrade. You can upgrade the firmware version by using the disc. To download the latest firmware version, please visit www.philips.com/support .
			Network Upgrade	Yes No	
Factory Default	Settings	Yes No		<p>"Yes": Resets all the settings, except for "Ratings Lock" and "Network Connection", in "Settings" to the factory default.</p> <p>"No": Does not perform the initialization.</p>	
	Format SD Card	Yes No		<p>"Yes": Re-format SD card.</p> <p>"No": Does not format the SD card.</p>	
	Local Storage	Player	Yes No	<p>"Yes": Re-format local storage (Player) used for BD-Java.</p> <p>"No": Does not perform the initialization.</p>	
			SD Card	Yes No	<p>"Yes": Re-format local storage (SD card) used for BD-Java.</p> <p>"No": Does not format the SD card.</p>
	Network Settings	Yes No		<p>"Yes": Initializes manually entered or automatic (default) network settings.</p> <p>"No": Does not perform the initialization.</p>	
Netflix Deactivate	Yes No		<p>"Yes": Deactivate the connection to Netflix.</p> <p>"No": Does not perform the deactivation.</p>		

EN

Introduction

Connections

Basic Setup

Playback

Function Setup

Others

SETUPS

TV Shape

home → "Settings" → "Advanced Setup" → "Video Output" → "TV Shape"

Use this feature to adjust the aspect ratio of the video source which is different from your TV's ratio to fit your TV monitor without distorting the picture. Descriptions of each setting are as follows:

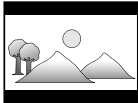
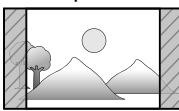
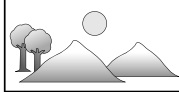
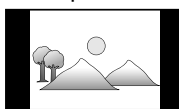
Video source	Your TV	Option	Description
16:9	4:3	4:3 Normal 	To enjoy 16:9 picture on 4:3 monitor: 16:9 picture is scaled down until both sides of the picture fits the 4:3 TV.
		4:3 Crop 	To enjoy 16:9 picture on 4:3 monitor: Both sides of the picture are trimmed to fit the 4:3 TV without distorting the aspect ratio of the picture.
4:3	16:9	16:9 Widescreen 	To enjoy 16:9 picture on 16:9 monitor: Select this setting when you want to enjoy 16:9 picture on the 16:9 TV.
		16:9 Squeeze 	To enjoy 4:3 picture on 16:9 monitor: Use this setting to display 4:3 picture on the 16:9 TV without distorting the aspect ratio of the picture.

HDMI Video Resolution

home → "Settings" → "Advanced Setup" → "Video Output" → "HDMI Video" → "HDMI Video Resolution"

Set the resolution of the video signal being output from the HDMI OUT jack.

You can select the desired "HDMI Video Resolution" among the settings listed below:

"Auto", "480p", "720p", "1080i", "1080p"

- When you make a selection, the TV monitor temporarily goes blank and then comes back again. If it does not, press **[HDMI]** to change the resolution or press and hold **[▶ (play)]** on the front panel for 5 seconds to change the setting back to its default.

Actual Output Resolution by Media:

Media	BD				
	Source				
Setting in the "HDMI Video Resolution"	480i/60	720p/60	1080i/60	720p/24	1080p/24
480p	480p/60	480p/60	480p/60	480p/60	480p/60
720p	720p/60	720p/60	720p/60	720p/60	720p/60
1080i	1080i/60	1080i/60	1080i/60	1080i/60	1080i/60
1080p	1080p/60	1080p/60	1080p/60	1080p/60	1080p/24 or 60 ^(*)
Auto	The highest resolution supported by your display device will be in effect automatically.				

^(*) To output the video in 24 Hz, the connected display device must support 24 Hz output, and "HDMI 1080p/24" should be set to "Auto". Otherwise, the image will be output in 60 Hz.

Media	DVD	AVCHD	DivX®	Photo viewing	OSD-only viewing
Setting in the "HDMI Video Resolution"	Source				
	480i/60	1080p/24	60, 30, other		
480p	480p/60	480p/60	480p/60	480p/60	480p/60
720p	720p/60	720p/60	720p/60	720p/60	720p/60
1080i	1080i/60	1080i/60	1080i/60	1080i/60	1080i/60
1080p	1080p/60	1080p/60	1080p/60	1080p/60	1080p/60
Auto	The highest resolution supported by your display device will be in effect automatically.				

- When HDMI cable is connected, only "480i" and the resolution selected in the "HDMI Video Resolution" will be available for the "Component Output".
- Composite video out (VIDEO OUT) can only output 480i/60.
- For AVCHD and DivX®, outputting the video in 24 Hz (1080p/24) is not available.

Note

- The selected resolution must also be supported by your display device.
- If your TV and the unit is connected by a DVI cable and if you select "Auto", "480p" will be in effect automatically.
- Pressing **[▶ (play)]** on the front panel for 5 seconds changes the setting back to its default. ("Component Output" setting will also be reset to default (480i).)
- Refer also to your TV's manual.

SETUPS

HDMI Audio

home → "Settings" → "Advanced Setup" → "Audio" → "HDMI Audio"

Refer to the table below to see which setting you should choose.

	"HDMI Audio" setting →	"HDMI Normal"		"PCM"		"Off"
	"Blu-ray Disc Audio" setting →	"Primary Audio Only"	"Mix Audio Output"	"Primary Audio Only"	"Mix Audio Output"	Regardless
Media ↓	Audio Source ↓	Which audio format can be output depends on the compatibility of the connected device.				
BD-video	Dolby Digital	Dolby Digital or Multi PCM or Mute	Dolby Digital or Multi PCM or Mute	Multi PCM or Mute	Multi PCM or Mute	Mute
	Dolby Digital Plus	Dolby Digital Plus or Dolby Digital or Multi PCM*1 or Mute	Dolby Digital or Multi PCM*2 or Mute	Multi PCM*1 or Mute	Multi PCM*2 or Mute	Mute
	Dolby TrueHD	Dolby TrueHD or Dolby Digital or Multi PCM*3 or Mute	Dolby Digital or Multi PCM*4 or Mute	Multi PCM*3 or Mute	Multi PCM*4 or Mute	Mute
	DTS®	DTS® or Multi PCM or Mute	DTS® or Multi PCM or Mute	Multi PCM or Mute	Multi PCM or Mute	Mute
	DTS-HD®	DTS-HD® or DTS® or Multi PCM*1 or Mute	DTS® or Multi PCM*5 or Mute	Multi PCM*1 or Mute	Multi PCM*5 or Mute	Mute
	LPCM	Multi PCM or Mute	Multi PCM or Mute	Multi PCM or Mute	Multi PCM or Mute	Mute
DVD-video	Dolby Digital	Dolby Digital, Multi PCM or Mute		Multi PCM or Mute		Mute
	DTS®	DTS®, Multi PCM or Mute		Multi PCM or Mute		Mute
	LPCM	2ch PCM or Mute		2ch PCM or Mute		Mute
DTS-CD	DTS®	DTS®, Multi PCM or Mute		Multi PCM or Mute		Mute
AVCHD	Dolby Digital	Dolby Digital or Multi PCM or Mute		Multi PCM or Mute		Mute
	LPCM	Multi PCM or Mute		Multi PCM or Mute		Mute

EN

Introduction

Connections

Basic Setup

Playback

Function Setup

Others

SETUPS

	"HDMI Audio" setting →	"HDMI Normal"		"PCM"		"Off"
	"Blu-ray Disc Audio" setting →	"Primary Audio Only"	"Mix Audio Output"	"Primary Audio Only"	"Mix Audio Output"	Regardless
Media ↓	Audio Source ↓	Which audio format can be output depends on the compatibility of the connected device.				
DivX®	Dolby Digital	Dolby Digital or Multi PCM or Mute		Multi PCM or Mute		Mute
	MP3 / MP2	2ch PCM or Mute		2ch PCM or Mute		Mute
Audio CD	PCM	2ch PCM or Mute		2ch PCM or Mute		Mute
MP3	MP3	2ch PCM or Mute		2ch PCM or Mute		Mute
Windows Media™ Audio	WMA	2ch PCM or Mute		2ch PCM or Mute		Mute
Netflix	WMA	2ch PCM or Mute		2ch PCM or Mute		Mute
CinemaNow	AAC	AAC or PCM or Mute		PCM or Mute		Mute
Blockbuster	AAC	AAC or PCM or Mute		PCM or Mute		Mute
vTuner	MP3 / WMA	2ch PCM or Mute		2ch PCM or Mute		Mute

*1) Full decoded.

*2) Only the independent substream is decoded.

*3) Dolby TrueHD stream is decoded.

*4) Only the Dolby Digital substream is decoded.

*5) Only the core substream is decoded.

- When playing back a BD-video which only contains the primary audio, the audio output will be the same case as the "Primary Audio Only" even if the "Blu-ray Disc Audio" is set to "Mix Audio Output".

Digital Out

home → "Settings" → "Advanced Setup" → "Audio" → "Digital Out"

Refer to the table below to see which setting you should choose.

	"Digital Out" setting →	"Bitstream"		"PCM"	
	"Blu-ray Disc Audio" setting →	"Primary Audio Only"	"Mix Audio Output"	"Primary Audio Only"	"Mix Audio Output"
Media ↓	Audio Source ↓				
BD-video	Dolby Digital	Dolby Digital	Dolby Digital	DownMix 2ch PCM	DownMix 2ch PCM
	Dolby Digital Plus	Dolby Digital	Dolby Digital	DownMix 2ch PCM ^{*1}	DownMix 2ch PCM ^{*2}
	Dolby TrueHD	Dolby Digital	Dolby Digital	DownMix 2ch PCM ^{*3}	DownMix 2ch PCM ^{*4}
	DTS®	DTS®	DTS®	DownMix 2ch PCM	DownMix 2ch PCM
	DTS-HD®	DTS®	DTS®	DownMix 2ch PCM ^{*1}	DownMix 2ch PCM ^{*5}
	LPCM	DownMix 2ch PCM	DownMix 2ch PCM	DownMix 2ch PCM	DownMix 2ch PCM
DVD-video	Dolby Digital	Dolby Digital		DownMix 2ch PCM	
	DTS®	DTS®		DownMix 2ch PCM	
	LPCM	2ch PCM		2ch PCM	
DTS-CD	DTS®	DTS®		DownMix 2ch PCM	
AVCHD	Dolby Digital	Dolby Digital		DownMix 2ch PCM	
	LPCM	DownMix 2ch PCM		DownMix 2ch PCM	
DivX®	Dolby Digital	Dolby Digital		DownMix 2ch PCM	
	MP3 / MP2	2ch PCM		2ch PCM	
Audio CD	PCM	2ch PCM		2ch PCM	
MP3	MP3	2ch PCM		2ch PCM	
Windows Media™ Audio	WMA	2ch PCM		2ch PCM	
Netflix	WMA	2ch PCM		2ch PCM	
CinemaNow	AAC	2ch PCM		2ch PCM	
Blockbuster	AAC	2ch PCM		2ch PCM	
vTuner	MP3 / WMA	2ch PCM		2ch PCM	

*1) Full decoded.

*2) Only the independent substream is decoded.

*3) Dolby TrueHD stream is decoded.

*4) Only the Dolby Digital substream is decoded.

*5) Only the core substream is decoded.

- When playing back a BD-video which only contains the primary audio, the audio output will be the same case as the "Primary Audio Only" even if the "Blu-ray Disc Audio" is set to "Mix Audio Output".

SETUPS

Ratings Lock

home → "Settings" → "Advanced Setup" → "Ratings Lock"

Some BD-video or DVD-video feature a ratings lock level. Playback will stop if the ratings exceed the levels you set, it will require you to enter a password before the disc will playback. This feature prevents your children from viewing inappropriate material.

1) With "Ratings Lock" selected in the "Advanced Setup" menu, press [OK].

Language	Rating Level
Video Output	New PIN
Audio	
Ratings Lock	
Network Connection	
Others	

2) If a PIN code has not been set, proceed to step 2-a).

If a PIN code has already been set, proceed to step 2-b).

If you want to change the PIN code, proceed to step 2-c).

If you forget the PIN code, proceed to step 2-d).

2-a) Enter 4 digit PIN code using [the Number buttons].

- "4737" cannot be used.
- Press [RED] to return to the previous screen.

2-b) Enter 4 digit PIN code using [the Number buttons].

2-c) Follow step 2-b). Select "New PIN", then press [OK]. Enter the new PIN code.

2-d) Enter "4737". Current PIN code and the "Ratings Lock" settings are now cleared. Follow step 1) and step 2-a) to create a new PIN code.

3) After entering the PIN code, "Rating Level" appears. (If not, use [▲ / ▼] to select "Rating Level".) Select desired rating level then press [OK].

Rating Level	All
New PIN	8 [Adult]
	7 [NC-17]
	6 [R]
	5 [PGR]
	4 [PG-13]
	3 [PG]
	2 [G]

	RATING EXPLANATIONS
All	• Ratings Lock Control is inactive; all discs can playback.
8 [Adult]	• DVD software of any grades (adult / general / children) can be played back.
7 [NC-17]	• No one under 17 admitted.
6 [R]	• Restricted; under 17 requires accompanying parent or adult guardian.
5 [PGR]	• Parental Guidance Recommended.
4 [PG-13]	• Unsuitable for children under 13.
3 [PG]	• Parental Guidance suggested.
2 [G]	• General Audience.
1 [Kid Safe]	• Suitable for children.

To cancel ratings lock temporarily

Some discs allow you to cancel the ratings lock temporarily. With those discs, the message below will appear when you try to play them back.

"Please enter your PIN to unblock content."

Follow the instruction which appears on the TV screen to cancel the ratings lock. After entering the PIN code, "Rating Level" appears.

Select desired rating level, then press [OK].

Network Connection

home → "Settings" → "Advanced Setup" → "Network Connection"

Set up the network connection settings in order to use BD-Live, Netflix / CinemaNow / Blockbuster feature, vTuner service or network upgrade function.

Connection Test

After you enable a network connection or change the network settings, always perform the connection test to check if the connection is correctly made.

- 1) Use [▲ / ▼] to select "Settings" in the home menu, then press [OK].
- 2) Use [▲ / ▼] to select "Advanced Setup", then press [OK].
- 3) Use [▲ / ▼] to select "Network Connection", then press [OK].
- 4) Use [▲ / ▼] to select "Connection Test", then press [OK]. Connection test will start automatically and the test result will appear right after the connection test finishes.
 - "Testing...": The test is in progress.
 - "Pass": Connection test is successfully completed.
 - "Fail": Connection test failed. Check the connection settings.

If the connection test passes, press [OK].
 • Confirmation screen of the network selection will appear.
 e.g.) Wired connection

Network Selection	Wired
	then press 'OK'.

Press [OK] again to display the confirmation screen of network settings.

IP Address	xxx.xxx.xxx.xxx
Subnet Mask	xxx.xxx.xxx.xxx
Default Gateway	xxx.xxx.xxx.xxx
Primary DNS	xxx.xxx.xxx.xxx
Secondary DNS	xxx.xxx.xxx.xxx
	then press 'OK'.

- 5) Press [OK] to go back to the previous screen, or press [▲ (home)] to go back to the home menu.

Note

- If the connection test passes, you are ready to use BD-Live, Netflix / CinemaNow / Blockbuster feature, vTuner service or network upgrade function using the Internet without making any extra settings.
- If the connection test fails, you may need to change the MAC address settings on your router. You can check the MAC address of this unit on "Network Status" screen (refer to page 55).
- When connecting this unit directly to a modem for the first time or connecting it to a modem which was previously connected to any other network device (e.g. a router, PC, etc.), you may have to power cycle the modem to reset the settings on the modem.

Enable (Wired)

Select "Enable (Wired)" if you made a wired connection and set the setting to "Standard"(wired) or "Manual"(wired), in accordance with your network environment.

Standard (Wired)

Network settings are set to the following settings initially. (In most cases, you can connect to the Internet without making any changes to the default settings.)

- IP Address Setting	Auto(DHCP)
- DNS Setting	Auto(DHCP)
- Proxy Setting	Do Not Use
- Connection Speed	Auto
- BD-Live Setting	Allow

If you want to set the network settings back to the default settings as above (except "BD-Live Setting"), follow the procedure below.

- 1) Follow steps 1) to 3) in "Connection Test" on page 53.
- 2) Use [▲ / ▼] to select "Network Selection", then press [OK].
- 3) Use [▲ / ▼] to select "Enable (Wired)", then press [OK].
- 4) Use [▲ / ▼] to select "Standard", then press [OK].
 - The unit will start the connection test automatically and the test result will appear right after the test finishes.
 - If the connection test passes, press [OK] to display the confirmation screen of the network selection.
 - Press [OK] again to display the confirmation screen of the network settings.
- 5) Press [OK] to activate the network settings and set the network connection automatically.
 Press [▲ (home)] to go back to the home menu.

Note

- The setting of "BD-Live Setting" will not be set back to the default, even if you follow the procedure.

Manual (Wired)

In following cases, select "Manual"(wired) to set each setting as necessary.

- When connection test failed with the setting of "Standard"(wired).
- When instructed by your Internet service provider to make specific settings in accordance with your network environment.

To set the network setting to "Manual"(wired), follow the following procedure.

- 1) Follow steps 1) to 3) in "Standard (Wired)" on page 53.
- 2) Use [▲ / ▼] to select "Manual", then press [OK].
 - Setting menu of "Manual"(wired) will be displayed. Set each setting as necessary.

SETUPS

IP Address Setting / DNS Setting

- 1) Use [▲ / ▼] to select "IP Address Setting", then press [OK].
- 2) Use [▲ / ▼] to select the desired setting, then press [OK].

"Auto(DHCP)"	: If your router has DHCP server function, select "Auto(DHCP)".
"Manual"	: If your router does not have DHCP server function, select "Manual".

If you select "Manual", follow the following instruction to set the IP address and DNS.

- 2-a) IP address setting screen will appear. Enter IP address, subnet mask and default gateway with cursor buttons and number buttons.

- Enter the IP address number after checking the specifications of your router.
- If the IP address is unknown, check the IP address of other devices. (e.g. PC connected via LAN cable) and assign a different number from those of other devices.

After you enter all correctly, press [OK] to go to the DNS setting screen.

- 2-b) DNS setting screen will appear. Enter primary DNS and secondary DNS with cursor buttons and number buttons.

- Enter the DNS addresses provided by your Internet provider.
- If the DNS address is unknown, check the DNS address of other devices (e.g. PC connected via LAN cable) and assign the same DNS address.

- 2-c) After you enter all correctly, press [OK].
 - Confirmation message will appear. Select "Yes" to complete the settings.

IP Address	xxx.xxx.xxx.xxx
Subnet Mask	xxx.xxx.xxx.xxx
Default Gateway	xxx.xxx.xxx.xxx
Primary DNS	xxx.xxx.xxx.xxx
Secondary DNS	xxx.xxx.xxx.xxx
Is Setting OK?	Yes
	No

- 3) Press [BACK ↩] to go back to the previous screen, or press [▲ (home)] to go back to the home menu.

Note

- The range of input numbers is between 0 and 255.
- If you enter a number larger than 255, the number will automatically be 255.
- The manually entered addresses will be saved even if you change the setting to "Auto(DHCP)".
- When you enter a wrong number, press [RED] to cancel. (the number will be back to "0".)
- If you want to enter 1 or 2 digit number in one cell, press [▶] to move on to the next cell.
- If the entered IP address or the default gateway or primary DNS address is same as the default setting, IP address setting will be set to "Auto(DHCP)". (The manually entered number will be saved).
- When IP address setting is set to "Manual", the setting of DNS setting will automatically be "Manual" and when IP address setting is set to "Auto(DHCP)", you can set either "Auto(DHCP)" or "Manual" for DNS setting.

Proxy Setting

- 1) Use [▲ / ▼] to select "Proxy Setting", then press [OK].
- 2) Use [▲ / ▼] to select the desired setting, then press [OK].

- For default settings, select "Do Not Use".
- If you need to change the proxy setting as instructed by your Internet service provider to set the designated proxy address and port, select "Use".

If you select "Use", follow the following instructions to set the proxy address and proxy port.

- 2-a) Proxy address setting screen will appear. Enter proxy address.
 - The keyboard screen will appear.

[▲ / ▼ / ◀ / ▶] : Move the highlight.

[the Number buttons] : Enter number.

[OK] : Enter the highlighted number / word.

*[RED] : Clear the entered number or word.

[GREEN] : Clear all the entered numbers or words.

[BLUE] : Switch between abc, ABC and @!?

*[YELLOW] : Set the entered number or word.

*These buttons can be used in other network settings.

After you enter all correctly, press [YELLOW] to go to the proxy port setting screen.

- 2-b) Enter proxy port number with number buttons.

- 2-c) After you enter all correctly, Press [YELLOW].
- Confirmation message will appear. Select "Yes" to complete the settings.

Proxy Address	xxxxxxxxxxxxxxxx
Proxy Port	xxxxx
	Is Setting OK?
	Yes
	No

- 3) Press [BACK ↩] to go back to the previous screen, or press [⬆ (home)] to go back to the home menu.

Note

- The range of input numbers for the port number is between 0 and 65535. (If you enter a number larger than 65535, it will be regarded as 65535.)
- For proxy port, certain ports might be closed, blocked or unusable depending on your network environment.
- If the proxy address is entered with blank only, proxy server setting will be set to "Do Not Use".

Connection Speed

You can set connection speed as your preference. (The default setting is "Auto".)

- 1) Use [▲ / ▼] to select "Connection Speed", then press [OK].
- 2) Use [▲ / ▼] to select the desired setting, then press [OK].

"Auto":

Set the appropriate connection speed automatically, in accordance with your network environment.

"10BASE Half":

Set the connection speed to "10BASE Half".

"10BASE Full":

Set the connection speed to "10BASE Full".

"100BASE Half":

Set the connection speed to "100BASE Half".

"100BASE Full":

Set the connection speed to "100BASE Full".

- 3) Press [BACK ↩] to go back to the previous screen, or press [⬆ (home)] to go back to the home menu.

Note

- Choose a connection speed in accordance with your network environment.
- The network connection may be disabled depending on the device, when the settings are changed.

BD-Live Setting

You can limit Internet access for BD-Live discs. (The default setting is "Allow".)

- 1) Use [▲ / ▼] to select "BD-Live Setting", then press [OK].
- 2) Use [▲ / ▼] to select the desired setting, then press [OK].

"Allow":

Internet access is permitted for all BD-Live contents.

"Limited Allow":

Internet access is permitted only for BD-Live contents which have content owner certificates. Internet access without the certificates is prohibited.

"Prohibit":

Internet access is prohibited for all BD-Live contents.

- 3) Press [BACK ↩] to go back to the previous screen, or press [⬆ (home)] to go back to the home menu.

Network Status

You can check the status of network settings.

- 1) Use [▲ / ▼] to select "Network Status", then press [OK].
 - Network setting list will be displayed.
 - MAC address of this unit will be displayed in the list.
- 2) Press [BACK ↩] to go back to the previous screen, or press [⬆ (home)] to go back to the home menu.

Enable (Wireless)

If you connect this unit to the network wirelessly, select "Enable (Wireless)" and set up necessary settings.

Wireless Router

In order to use a wireless network, you must set up the connection to the wireless router.

Find wireless network

Search for wireless networks automatically and select the wireless network name (SSID) from the list.

- 1) Follow steps 1) to 2) in "Standard (Wired)" on page 53.
- 2) Use [▲ / ▼] to select "Enable (Wireless)", then press [OK].
- 3) Use [▲ / ▼] to select "Wireless Router", then press [OK].
- 4) Use [▲ / ▼] to select "Find wireless network", then press [OK].
 - This unit will start searching for wireless networks automatically.

SETUPS

- 5) The list of wireless networks will be displayed. Use [▲ / ▼] to select the appropriate wireless network name (SSID), then press [OK].

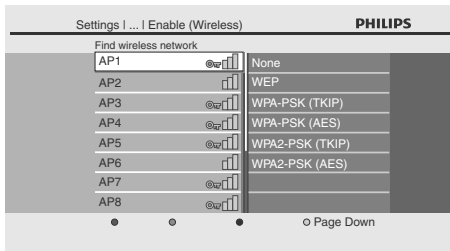

- 6) Use [▲ / ▼] to select the authentication setting of the selected wireless network.

- For a wireless network with authentication setting, select the authentication setting, according to the security type of the wireless network.
- For a wireless network without authentication setting, select "None".

"None":

Set the authentication setting to "None".

"WEP":

Set the authentication setting to "WEP".

"WPA-PSK (TKIP)":

Set the authentication setting to "WPA-PSK (TKIP)".

"WPA-PSK (AES)":

Set the authentication setting to "WPA-PSK (AES)".

"WPA2-PSK (TKIP)":

Set the authentication setting to "WPA2-PSK (TKIP)".

"WPA2-PSK (AES)":

Set the authentication setting to "WPA2-PSK (AES)".

- If you select "WEP", "WPA-PSK (TKIP)", "WPA-PSK (AES)", "WPA2-PSK (TKIP)" or "WPA2-PSK (AES)", "WEP/WPA Key" entry screen will appear.

Enter the WEP/WPA key of the selected wireless network using cursor buttons, number buttons and color key, then press [YELLOW].

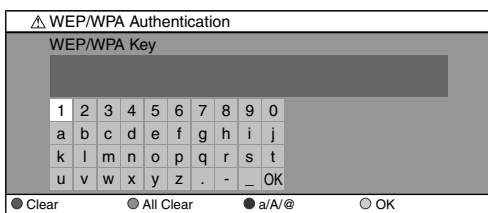

- Confirmation message will appear. Select "Yes" to complete the settings.

SSID	AP1
WEP/WPA Authentication	WPA2-PSK (AES)
WEP/WPA Key	xxxxxxxxxxxxxxxxxxxxx...
	Is Setting OK?
	Yes
	No

- 7) Following screen will appear. Use [◀ / ▶] to select "Yes", then press [OK] to go to "Advanced Settings".
- For further operation, refer to "Advanced Settings" on page 57.
 - To go back to the home menu, press [⬆ (home)].

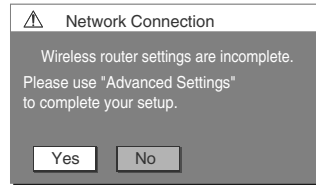

Note

- For a wireless network with authentication setting, key icon appears to the right hand of the wireless network name (SSID).
- Signal icon shows the strength of the signal.
- WEP/WPA key appears as asterisks on the confirmation screen.
- The supplied USB wireless LAN adaptor supports following specifications.
 - Wifi standards : IEEE 802.11 b/g/n
 - Frequency spectrum : 2.4GHz
 - Security protocol : WEP / WPA / WPA2

Manually enter your SSID

Set up the connection to the wireless router manually by entering the wireless network name (SSID).

- 1) Follow steps 1) to 3) in "Find wireless network" on pages 55-56.

- 2) Use [▲ / ▼] to select "Manually enter your SSID", then press [OK].

- Wireless Router Name (SSID) entry screen will appear. Enter the wireless network name (SSID) using cursor buttons, number buttons and color key, then press [YELLOW].

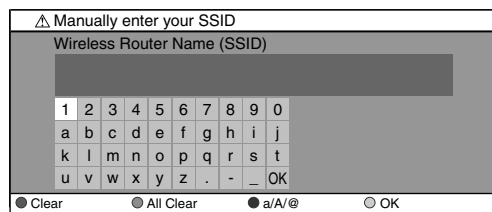

- 3) Follow steps 6) to 7) in "Find wireless network" on pages 55-56.

Wireless Router Status

You can check the current status of "Wireless Router" setting.

- 1) Follow steps 1) to 3) in "Find wireless network" on pages 55-56.

- 2) Use [▲ / ▼] to select "Wireless Router Status", then press [OK].

- The list of current wireless router setting will be displayed.

- 3) Press [BACK ↶] to go back to the previous screen, or press [⬆ (home)] to go back to the home menu.

Advanced Settings

After you set up the "Wireless Router" setting, set the network setting to "Standard" (wireless) or "Manual"(wireless).

Standard (wireless)

To set the network setting to "Standard"(wireless), follow the following procedure. For details of this setting, refer to "Standard (Wired)" on page 53.

- If you select "Yes" in step 7) of "Find wireless network" on pages 55-56, skip to step 3).

- 1) Follow steps 1) to 2) in "Find wireless network" on pages 55-56.
- 2) Use [▲ / ▼] to select "Advanced Settings", then press [OK].
- 3) Use [▲ / ▼] to select "Standard", then press [OK].

Manual (wireless)

To set the network setting to "Manual"(wireless), follow the following procedure.

- If you select "Yes" in step 7) of "Find wireless network" on pages 55-56, skip to step 3).

- 1) Follow steps 1) to 2) in "Find wireless network" on pages 55-56.
- 2) Use [▲ / ▼] to select "Advanced Settings", then press [OK].
- 3) Use [▲ / ▼] to select "Manual", then press [OK].
 - For details of each setting, refer to following pages.

"IP Address Setting" / "DNS Setting":

Refer to "IP Address Setting / DNS Setting" on page 54.

"Proxy Setting":

Refer to "Proxy Setting" on page 54.

"BD-Live Setting":

Refer to "BD-Live Setting" on page 55.

"Network Status":

Refer to "Network Status" on page 55.

Note

- You cannot select "Advanced Settings" if "Wireless Router" setting is not completed.

Disable

Deactivate all the network connection and settings.

- 1) Follow steps 1) to 2) in "Standard (Wired)" on page 53.
- 2) Use [▲ / ▼] to select "Disable", then press [OK].
- 3) Use [▲ / ▼] to select "Yes", then press [OK].
- 4) Press [BACK ↵] to go back to the previous screen, or press [▲ (home)] to go back to the home menu.

Note

- The network connection can be reactivated by setting the network connection to "Enable (Wired)" or "Enable (Wireless)".

EasyLink (HDMI CEC)

home → "Settings" → "Advanced Setup" → "Others" → "EasyLink (HDMI CEC)"

This unit supports Philips EasyLink, which enables your TV (limited to PHILIPS brand EasyLink TV) to act in conjunction with this unit, or vice versa. Compliant TV must be connected to the HDMI OUT jack.

When "EasyLink (HDMI CEC)" setting is set to "On", functions listed below will be available.

One Touch Play

When the operations with following buttons of the remote control of this unit are performed, the TV will automatically be turned on and switched to the appropriate input channel.

Buttons for one touch play:

- [▶ (play)], [◀ (previous)], [▶ (next)], [the Number buttons], [▲ (home)], or [INFO ⓘ]
- [TOP MENU], or [DISC MENU / POP-UP MENU] (when a disc is inserted in the unit)

Standby

When you press and hold [⏻ (standby/on)] for 2 seconds, it turns off the power of the TV first and then turns off the power of this unit also.

System Information

Get & Set Menu Language

The unit recognizes the OSD language set for the TV and automatically sets the same language as the player menu language (OSD menu language) for this unit. Refer to the "Player Menu" on page 42 for available languages.

- This feature is available only when "Auto" is selected in the "Player Menu" in the settings menu.

Software Upgrade

home → "Settings" → "Advanced Setup" → "Others" → "Software Upgrade"

Philips continuously tries to improve its products and we strongly recommend that you update the software when updates are available. New software can be downloaded from our website at www.philips.com using the type number of your Blu-ray Disc Player (e.g. BDP5320) to find information.

Disc Upgrade

You can upgrade the software by using disc.

- 1) Follow steps 1) to 2) in "Connection Test" on page 53.
- 2) Use [▲ / ▼] to select "Others", then press [OK].
- 3) Use [▲ / ▼] to select "Software Upgrade", then press [OK].
- 4) Use [▲ / ▼] to select "Disc Upgrade", then press [OK].
- 5) Use [▲ / ▼] to select "Yes", then press [OK].
- 6) Disc tray will open automatically.
 - Insert the disc for software upgrade and then press [▲ (open/close)].
- 7) After completing loading disc, confirmation message will appear. Use [◀ / ▶] to select "Yes" and press [OK] to start upgrading.
 - It may take a while to complete the upgrading.
- 8) After the disc upgrade finishes, this unit will restart and open the disc tray automatically. Remove the disc.

Note

- Please visit www.philips.com to download the latest firmware version.
- Please do not unplug the AC power cord while executing the "Disc Upgrade".
- All settings will remain the same even if you upgrade the firmware version.
- The version of Netflix will also be upgraded if newer version of Netflix is available when upgrading the firmware.

Network Upgrade

You can upgrade the software by connecting the unit to the Internet.

- 1) Follow steps 1) to 2) in "Connection Test" on page 53.
- 2) Use [▲ / ▼] to select "Others", then press [OK].
- 3) Use [▲ / ▼] to select "Software Upgrade", then press [OK].
- 4) Use [▲ / ▼] to select "Network Upgrade", then press [OK].
- 5) Use [▲ / ▼] to select "Yes", then press [OK].
 - This unit will then start checking for the latest firmware version.
- 6) Confirmation message will appear. Use [◀ / ▶] to select "Yes", then press [OK].
 - The unit will start downloading the latest firmware version.
- 7) When the download completes, confirmation message will appear. Press [OK].
 - The unit will start upgrading the firmware version.
 - It may take a while to complete the upgrading.

- 8) After upgrading finishes, this unit will restart and open the disc tray automatically.

Note

- In order to upgrade the software via the Internet, you must connect the unit to the Internet and set up necessary settings.
- For the network connection, refer to "Connection to the Network" on page 20.
- For the network setup, refer to "Network Connection" on page 53.
- Please do not unplug the AC power cord, LAN cable or USB wireless LAN adapter while executing the "Network Upgrade".
- All settings will remain the same even if you upgrade the software version.
- The disc tray will open automatically after upgrading finishes. This is not a malfunction.
- The version of Netflix will also be upgraded if newer version of Netflix is available when upgrading the firmware.

Reset to Factory Default

home → "Settings" → "Factory Default"

Initialize the setting, SD Memory Card, network setting or deactivate Netflix.

- 1) Use [▲ / ▼] to select "Settings" in the home menu, then press [OK].
- 2) Use [▲ / ▼] to select "Factory Default", then press [OK].
- 3) Use [▲ / ▼] to select the desired setting, then press [OK].

"Settings":

All the settings except for the "Ratings Lock" and "Network Connection" setting will be reset to default.

"Format SD Card" (Available only when an SD Memory Card is inserted):

Initialize the SD Memory Card.

"Local Storage":

Local storage for Player or SD card (Available only when an SD Memory Card is inserted) used for BD-Java will be initialized.

"Network Settings":

Reset the network setting to the default.

"Netflix Deactivate":

Deactivate the connection to Netflix.

- 4) Use [▲ / ▼] to select "Yes", then press [OK].
 - Confirmation message will appear. Press [OK] to complete the setting.
- 5) Press [BACK ↵] to go back to the previous screen, or press [▲ (home)] to go back to the home menu.

Note

- Do not remove the SD Memory Card while executing the "Format SD Card" or "Local Storage" (SD card). It will damage the card.
- "Format SD Card" and "Local Storage" (SD card) are not available when a Blu-ray Disc is in the unit.

TROUBLESHOOTING

EN

	Problem	Tip
POWER	No reaction to the remote control.	Connect the product to the power outlet. Point the remote control at the product. Insert the batteries correctly. Insert new batteries in the remote control.
	No video signal on the display device.	Turn on the TV. Set the TV to the correct external input. Select the correct video resolution using [HDMI] . Press and hold [▶ (play)] on the front panel for 5 seconds to change the setting back to its default.
	No audio / video signal on the display device via HDMI cable.	If the unit is connected to the unauthorized display device with an HDMI cable, the audio / video signal may not be output. Perform an HDMI cable hotplug, wherein you disconnect the HDMI cable from the TV and this unit and then reconnect it to both the devices while they are powered on. Ensure that your HDMI cable is certified.
	No high-definition video signal on the TV.	Does the disc contain high-definition video? High-definition video is not available when the disc does not contain it. Does the TV support high-definition video? High-definition video is not available when the TV does not support it.
	No audio signal from the loudspeakers of the TV.	Assign the audio input of the TV to the corresponding video input. Ensure that the TV's speakers are turned on in the TV menu. Ensure that the TV speakers are not muted.
	No audio signal from the loudspeakers of the audio system.	Turn on the audio system. Set the audio system to the correct external input. Increase the volume level of the audio system.
GENERAL	Cannot play back a disc.	Make sure that the product supports the disc. Check the region code of the disc. This unit supports following region codes. -BD : "A" -DVD : "ALL" or "1" for BDP5320/F7 (USA / Canada) "ALL" or "4" for BDP5320/F8 (Mexico) For DVD-RW/-R, make sure that the disc is finalized. Clean the disc.
	SD Memory Card cannot be read.	The format of the card does not match that accepted by this unit or the card is not compatible.
	Cannot play back JPEG files from a disc.	Make sure that the disc was recorded in the UDF, ISO9660 or JOLIET format.
	Cannot play back MP3 files from a disc.	Make sure that the disc was recorded in the UDF, ISO9660 or JOLIET format. Make sure that the bit rate of the MP3 files is between 112 and 320 kbps. Make sure that the sample rate of the MP3 files is 32 kHz, 44.1 kHz or 48 kHz.
	Cannot play back Windows Media™ Audio files from a disc.	Make sure that the sample rate of the Windows Media™ Audio files is 44.1 kHz or 48 kHz.
	Cannot play back DivX® files from a disc.	Make sure that the file extension is .avi, .AVI, .divx or .DIVX. Ensure that the DivX® video on the disc meets the DivX® playback capabilities of this device outlined on page 27.

Introduction

Connections

Basic Setup

Playback

Function Setup

Others

TROUBLESHOOTING

Problem	Tip
✕ in the upper right hand corner of the TV screen.	The operation is not possible.
Buttons do not work or the unit stops responding.	To completely reset the unit, press and hold [⏻ (standby/on)] on the front panel for 10 seconds to shut down the unit or unplug the AC cord from the AC outlet for 5-10 seconds.
Cannot find a JPEG file.	Make sure that the selected group (folder) does not contain more than 9,999 files for BD / DVD / SD card, and 999 files for CD. Make sure that the file extension is .jpg, .JPG, .jpeg or .JPEG.
Cannot find an MP3 and Windows Media™ Audio file.	Make sure that the selected folder does not contain more than 9,999 files for BD / DVD / SD card, and 999 files for CD. Make sure that the file extension is .mp3 or .MP3 for MP3, and .wma or .WMA for Windows Media™ Audio.
Error message appears when I select "Auto" in the "Player Menu".	Make sure that the unit is connected to the PHILIPS brand EasyLink TV and the "EasyLink (HDMI CEC)" is set to "On". This error message may appear when your TV's OSD language is not supported by this unit.
Cannot connect to the network.	Check if the network connection is properly made. Turn on the modem or router. Check the network settings. Check if the router and/or modem is correctly connected. Check the "BD-Live Setting". When connecting directly to a modem via a LAN cable, you might need to power cycle the modem to reset settings on the modem.
Cannot use the wireless connection.	Check if the USB wireless LAN adapter is connected to the Wireless LAN terminal. Use the supplied USB wireless LAN adapter. Commercially available USB wireless LAN adapters are not supported. Once you have activated the wireless connection please wait 30 seconds for the connection to be established after turning on the unit, before trying to access network features such as BD-Live, Netflix, CinemaNow, Blockbuster or vTuner.
Cannot connect to the network while my PC is connected to the network.	Check the content of your Internet service contract to see if your Internet Service Provider prevents multiple terminals connecting at the same time.
The capacity of the SD card decreased.	Data may be written to the SD card when a BD-video that supports the virtual package is used and an SD card is in the slot.
MPEG-2 video and audio on the SD card cannot be played back.	MPEG-2 is noncompliant on this unit.
The contents of the card cannot be read.	The card is not compatible or the contents on the card may be damaged. Turn off and then turn the unit on again.
Cannot use the BD-Live function or download of data does not perform properly.	Insert an SD card with enough capacity(1GB or more). Check if an SD card is correctly inserted. Make sure the write-protect switch on the SD card is not enabled.
Cannot play back BD-video(BD-ROM Profile 2.0).	Insert an SD card(1GB or more) which is formatted on this unit. Some discs with BD-Live function require memory when playing back the content. Do not remove the card during playback. Make sure the write-protect switch on the SD card is not enabled.
Cannot use Netflix feature.	Netflix is available only in the United States. Check if the network connection is properly made. Visit netflix.com/Philips on your PC and become a Netflix member.
Cannot add movies or TV episodes to the instant Queue.	Visit netflix.com on your PC. Adding movies or TV episodes on this unit is not available.
Even though the speed of the Internet connection improves during playback, the picture quality of Netflix streaming movie does not improve.	The picture quality does not change during playback. The picture quality differs depending on the speed of Internet connection at the time of loading.

GENERAL

TROUBLESHOOTING

EN

Problem	Tip
The picture quality of streaming movie (Netflix, CinemaNow or Blockbuster) is poor.	Check the speed of your Internet connection.
Streaming movie (Netflix, CinemaNow or Blockbuster) often stops or start buffering during playback.	Contact your Internet service provider. (You may need to improve the broadband speed.)
Cannot use CinemaNow / Blockbuster feature.	Check if the network connection is properly made. Visit www.cinemanow.com/Login (CinemaNow) or www.blockbuster.com/auth/login (Blockbuster) on your PC and create an account.
Cannot play back Internet radio.	Check if the network connection is properly made. Check the firewall setting of the modem or router. For some stations, playback is not available on this unit.
Cannot play back the Internet radio station in my favorite list.	The station is busy or no longer active. Try again later.
The audio of Internet radio station interrupted.	vTuner server, station or the Internet connection is busy. The bit rate of the station is high.
The quality of the Internet radio audio is poor or noise occurs during playback of Internet station.	The bit rate of the station is low.

Downloading an Electronic Copy

To obtain an electronic copy of this manual :

- 1) **Point your browser to www.philips.com/support.**
- 2) **Choose your country of location.**
- 3) **Enter the model number or a keyword in the "Find your product" field. Alternatively, you can browse the catalog.**
- 4) **Click the description or model.**
- 5) **Under Product support, click "User manuals".**

Contact Us

If you cannot resolve your problem, refer to the FAQ for this Blu-ray Disc Player at www.philips.com/support.
If the problem remains unresolved, contact the Customer Support Center in your country.

Note

- Do not attempt to repair the Blu-ray Disc Player yourself. This may cause severe injury, irreparable damage to your Blu-ray Disc Player or void your warranty.
- Please have available your Blu-ray Disc Player model and serial number before contacting us. These numbers are available on the cabinet, as well as on the packaging.

Introduction

Connections

Basic Setup

Playback

Function Setup

Others

GLOSSARY

Analog Audio

An electrical signal that directly represents sound. Compare this to digital audio which can be an electrical signal, but is an indirect representation of sound. See also "Digital Audio".

Aspect Ratio

The width of a TV screen relative to its height. Conventional TVs are 4:3 (in other words, the TV screen is almost square); widescreen models are 16:9 (the TV screen is almost twice as wide as it is high).

AVCHD

AVCHD is a new format for high definition video camcorders which can record and play high-resolution HD images.

BD-Live

BD-Live is a BD-video (BD-ROM version 2 Profile 2.0) which contains new functions (e.g. Internet connection), in addition to the BONUSVIEW function.

Blockbuster

Blockbuster is online service which you can rental or purchase movies and TV episodes streamed over the Internet.

Blu-ray Disc (BD)

Blu-ray Disc is a next generation optical video disc which is capable of storing much more data than a conventional DVD. The large capacity makes it possible to benefit from the features such as high-definition videos, multi-channel surround sounds, interactive menus and so on.

Chapter

Just as a book is split up into several chapters, a title on a BD-video or DVD-video is usually divided into chapters. See also "Title".

CinemaNow

CinemaNow is online service which you can rental or purchase movies and TV episodes streamed over the internet.

Component Video Output

Each signal of luminance (Y) and component (P_B/C_B, P_R/C_R) is independent to output so that you can experience picture color as it is.

Also, due to compatibility with progressive video (525p/480p), you can experience higher-density picture than that in interlace (525i/480i).

Digital Audio

An indirect representation of sound by numbers. During recording, the sound is measured at discrete intervals (44,100 times a second for CD audio) by an analog-to-digital converter, generating a stream of numbers. On playback, a digital-to-analog converter generates an analog signal based on these numbers. See also "Sampling Frequency" and "Analog Audio".

DivX®

DivX® is a codec (compression/decompression) that can compress pictures to a very small amount of data. The software can compress video data from almost any devices to the size that can be sent on the Internet without compromising visual quality of the pictures.

DNS Server

A server which translates Internet domain names into IP addresses.

Dolby Digital

The system to compress digital sound developed by Dolby Laboratories. It offers you sound of stereo (2ch) or multi-channel audio.

Dolby Digital Plus

Dolby Digital Plus is the next generation digital audio compression technology developed as an extension to Dolby Digital. Blu-ray Disc supports 7.1 multi-channel surround sound output.

Dolby TrueHD

Dolby TrueHD is a lossless coding technology developed for next generation optical discs. Blu-ray Disc supports 7.1 multi-channel surround sound output.

DTS® (Digital Theater System)

DTS® is a multi channel surround sound system. You can enjoy movie dynamic and realistic sound like movie theater. DTS surround sound technologies were developed by DTS, Inc.

DTS-HD®

DTS-HD® is a lossless coding technology developed as an extension of the original DTS Coherent Acoustics format. Blu-ray Disc supports 7.1 multi-channel surround sound output.

Gateway

IP address of the electronic devices (such as router) which provide Internet access.

HDMI (High Definition Multimedia Interface)

A digital interface between audio and video source. It can transmit component video, audio, and control signal with one cable connection.

Hub

A device used for connecting multiple device to the network.

IP Address

A set of numbers which are assigned to devices participating in a computer network.

JPEG (Joint Photographic Experts Group)

JPEG is a method of compressing still picture files. You can copy JPEG files on CD-RW/-R, DVD-RW/-R, BD-RE/-R or SD Memory Card from a computer and play back the files on this unit.

LAN (Local Area Network)

A group of computer networks covering a small area like a company, school or home.

Local Storage

A storage area of sub contents for playing virtual packages on BD-video.

MP3 (MPEG audio layer 3)

MP3 is a method of compressing files. You can copy MP3 files on CD-RW/-R, DVD-RW/-R, BD-RE/-R or SD Memory Card from the computer and play back the files on this unit.

Netflix

Netflix is online movie rental service, offering online streaming to customers in the United States.

PCM (Pulse Code Modulation)

The most common system of encoding digital audio, found on CD and DAT. Excellent quality, but requires a lot of data compared to formats such as Dolby Digital and MPEG audio. For compatibility with digital audio recorders (CD, MD and DAT) and AV amplifiers with digital inputs, this unit can convert Dolby Digital, DTS, and MPEG audio to PCM. See also "Digital Audio".

Proxy Server

Proxy server is a server which acts as an intermediary between a workstation user and the Internet to ensure security.

Region Code

Regions associate discs and players with particular areas of the world. This unit will only play back discs that have compatible region codes. You can find the region code of your unit by looking on the rear panel. Some discs are compatible with more than one region (or all regions).

Router

A networking device which distinguishes the IP address assigned to each device and routing and forwarding information in the computer network.

Sampling Frequency

The rate which sound is measured by a specified interval to turn into digital audio data. The numbers of sampling in one second defines as sampling frequency. The higher the rate, the better the sound quality.

Subnet Mask

A mask which is used to determine what subnet an IP address belongs to.

Title

A collection of chapters on BD-video or DVD-video. See also "Chapter".

Track

Audio CD uses tracks to divide up the content of a disc. The BD-video or DVD-video equivalent is called a chapter. See also "Chapter".

Virtual Package

The function which copies data to other media (local storage) from the Internet and plays secondary video, secondary audio and subtitles at the same time. The method of the playback varies depending on discs.

vTuner

vTuner is a database service of Internet radio. vTuner enables users to access various kinds of Internet radio stations through its database.

Windows Media™ Audio

Windows Media™ Audio is the audio compressing technology developed by Microsoft. You can copy Windows Media™ Audio files on CD-RW/-R, DVD-RW/-R or SD Memory Card from a computer and play them back on this unit.

x.v.Color

"x.v.Color" is a promotion name given to the products that have the capability to realize a wide color space based on the xvYCC specifications and is a trademark of Sony Corporation.

SPECIFICATIONS

General

Signal System	NTSC Color
Power requirements	120 V AC, 60 Hz
Power consumption	16 W (standby: 0.5 W)
Dimensions (width x height x depth)	17.2 x 2.0 x 8.5 inches (435 x 50 x 215 mm)
Weight	5.07 lbs. (2.3 kg)
Operating temperature	41°F (5°C) to 104°F (40°C)
Operating humidity	Less than 80 % (no condensation)

Terminals

Front	SD card slot			
	slot x 1			
Rear	Audio output (Analog)			
	RCA jack x 2	L/R: 2 Vrms (output impedance: more than 1kΩ)		
	Video output			
	RCA jack x 1	1 Vp-p (75Ω)		
	Component video output			
	RCA jack x 3	Y: 1 Vp-p (75Ω)	P _B /C _B : 700 mVp-p (75Ω)	P _R /C _R : 700 mVp-p (75Ω)
	Audio output (Digital)			
	RCA jack x 1	500 mVp-p (75Ω)		
HDMI output				
HDMI jack x 1	Video: 480p, 720p, 1080i, 1080p, 1080p24/Audio			
LAN terminal	10BASE-T / 100BASE-TX			
Wireless LAN terminal	IEEE 802.11 b/g/n			

Note

- The specifications and design of this product are subject to change without notice.

Network Service Disclaimer

Content and services made available through this product are transmitted by third parties by means of networks and transmission facilities over which Company has no control and third party services may be terminated or interrupted at any time, and Company makes no representation or warranty that any content or service will remain available for any period of time. Without limiting the generality of this disclaimer, Company expressly disclaims any responsibility for any interruption or suspension of any content or service made available through this product. Company is not responsible for customer service related to the content and services. Any question or request for service relating to the content or services should be made directly to the respective content and service providers.

THIRD PARTY CONTENT AND SERVICES MADE AVAILABLE THROUGH THIS PRODUCT ARE PROVIDED "AS IS." COMPANY DOES NOT WARRANT CONTENT OR SERVICES SO PROVIDED, FOR ANY PURPOSE WHATSOEVER. COMPANY EXPRESSLY DISCLAIMS ANY WARRANTIES, EXPRESS OR IMPLIED INCLUDING WITHOUT LIMITATION, WARRANTIES OF MERCHANTABILITY OR FITNESS FOR A PARTICULAR PURPOSE, ACCURACY, VALIDITY, TIMELINESS, LEGALITY, SUITABILITY, OR QUALITY OF ANY CONTENT OR SERVICE MADE AVAILABLE THROUGH THIS PRODUCT.

IN NO EVENT SHALL COMPANY BE LIABLE FOR, ANY DAMAGES, WHETHER ARISING IN CONTRACT OR TORT, INCLUDING WITHOUT LIMITATION, ANY DIRECT, INDIRECT, INCIDENTAL, SPECIAL OR CONSEQUENTIAL DAMAGES, LOST PROFITS, ATTORNEY FEES, EXPENSES, OR ANY OTHER DAMAGES ARISING OUT OF, OR IN CONNECTION WITH, ANY CONTENT (OR ANY INFORMATION CONTAINED THEREIN) OR SERVICE PROVIDED TO THE USER OR ANY THIRD PARTY, EVEN IF ADVISED OF THE POSSIBILITY OF SUCH DAMAGES.

All content and services accessible through this product belong to third parties and are protected by copyright, patent, trademark and/or other intellectual property rights. Such content and services are provided solely for the User's personal noncommercial use. User may not use any content or services in a manner that has not been authorized by the content owner or service provider. Without limiting the foregoing, unless expressly authorized by the applicable content owner or service provider, you may not modify, copy, republish, upload, post, transmit, translate, sell, create derivative works, exploit, or distribute in any manner or medium any content or services made available through this product.

ONE (1) YEAR LIMITED WARRANTY

WARRANTY COVERAGE:

This warranty obligation is limited to the terms set forth below.

WHO IS COVERED:

This product is warranted to the original purchaser or the person receiving the product as a gift against defects in materials and workmanship as based on the date of original purchase ("Warranty Period") from an Authorized Dealer. The original sales receipt showing the product name and the purchase date from an authorized retailer is considered such proof.

WHAT IS COVERED:

This warranty covers new products if a defect in material or workmanship occurs and a valid claim is received within the Warranty Period. At its option, the company will either (1) repair the product at no charge, using new or refurbished replacement parts, or (2) exchange the product with a product that is new or which has been manufactured from new, or serviceable used parts and is at least functionally equivalent or most comparable to the original product in current inventory, or (3) refund the original purchase price of the product. The Company warrants replacement products or parts provided under this warranty against defects in materials and workmanship from the date of the replacement or repair for ninety (90) days or for the remaining portion of the original product's warranty, whichever provides longer coverage for you. When a product or part is exchanged, any replacement item becomes your property and the replaced item becomes the company's property. When a refund is given, your product becomes the company's property. **Note: Any product sold and identified as refurbished or renewed carries a ninety (90) day limited warranty.**

Replacement product can only be sent if all warranty requirements are met. Failure to follow all requirements can result in delay.

WHAT IS NOT COVERED - EXCLUSIONS AND LIMITATIONS:

This Limited Warranty applies only to the new products that can be identified by the trademark, trade name, or logo affixed to it. This Limited Warranty does not apply to any non-Philips hardware product or any software, even if packaged or sold with the product. Non-Philips manufacturers, suppliers, or publishers may provide a separate warranty for their own products packaged with the bundled product.

The Company is not liable for any damage to or loss of any programs, data, or other information stored on any media contained within the product, or any non-Philips product or part not covered by this warranty. Recovery or reinstallation of programs, data or other information is not covered under this Limited Warranty.

This warranty does not apply (a) to damage caused by accident, abuse, misuse, neglect, misapplication, or non-Philips product, (b) to damage caused by service performed by anyone other than an Authorized Service Location, (c) to a product or

a part that has been modified without written permission, or (d) if any serial number has been removed or defaced, or (e) product, accessories or consumables sold "AS IS" without warranty of any kind by including refurbished Philips product sold "AS IS" by some retailers.

This Limited Warranty does not cover:

- Shipping charges to return defective product.
- Labor charges for installation or setup of the product, adjustment of customer controls on the product, and installation or repair of antenna/signal source systems outside of the product.
- Product repair and/or part replacement because of improper installation or maintenance, connections to improper voltage supply, power line surge, lightning damage, retained images or screen markings resulting from viewing fixed stationary content for extended periods, product cosmetic appearance items due to normal wear and tear, unauthorized repair or other cause not within the control of the company.
- Damage or claims for products not being available for use, or for lost data or lost software.
- Damage from mishandled shipments or transit accidents when returning product.
- A product that requires modification or adaptation to enable it to operate in any country other than the country for which it was designed, manufactured, approved and/or authorized, or repair of products damaged by these modifications.
- A product used for commercial or institutional purposes (including but not limited to rental purposes).
- Product lost in shipment and no signature verification receipt can be provided.
- Failure to operate per Owner's Manual.

TO OBTAIN ASSISTANCE IN THE U.S.A., CANADA, PUERTO RICO, OR U.S. VIRGIN ISLANDS...

Contact Customer Care Center at:
1-866-309-0866

REPAIR OR REPLACEMENT AS PROVIDED UNDER THIS WARRANTY IS THE EXCLUSIVE REMEDY FOR THE CONSUMER. PHILIPS SHALL NOT BE LIABLE FOR ANY INCIDENTAL OR CONSEQUENTIAL DAMAGES FOR BREACH OF ANY EXPRESS OR IMPLIED WARRANTY ON THIS PRODUCT. EXCEPT TO THE EXTENT PROHIBITED BY APPLICABLE LAW, ANY IMPLIED WARRANTY OF MERCHANTABILITY OR FITNESS FOR A PARTICULAR PURPOSE ON THIS PRODUCT IS LIMITED IN DURATION TO THE DURATION OF THIS WARRANTY.

Some states do not allow the exclusions or limitation of incidental or consequential damages, or allow limitations on how long an implied warranty lasts, so the above limitations or exclusions may not apply to you.

This warranty gives you specific legal rights. You may have other rights which vary from state/province to state/province.

P&F USA, Inc.
PO Box 430 Daleville, IN 47334-0430

Introduction

Connections

Basic Setup

Playback

Function Setup

Others

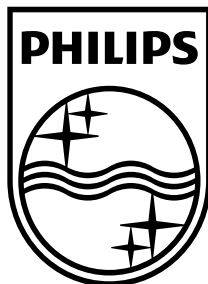

P&F USA, Inc.
PO Box 430 Daleville, IN 47334-0430

P&F Mexicana, S.A. de C.V.
Av. La Palma No. 6, Col. San Fernando La Herradura,
Huixquilucan Edo. de México C.P. 52787

Meet Philips at the Internet
<http://www.philips.com/welcome>

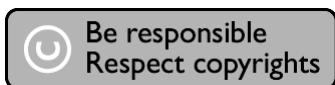



	ENERGIA
BDP5320	120 V ~ 60 Hz 16 W

Comercializado por : P&F Mexicana, S.A. DE C.V.

IMPORTADOR: Sojitz Mexicana, S.A. de C.V.
Av. Paseo de las Palmas no. 239-302
Col. Lomas de Chapultepec, c.p. 11000
México, D.F. 52 (55) 5202 - 7222

EXPORTADOR : FUNAI ELECTRIC CO. L.T.D.

País de Origen : CHINA

GARANTIA INCLUIDA EN EL INSTRUCTIVO DE USO  

LEA CUIDADOSAMENTE ESTE INSTRUCTIVO
ANTES DE USAR SU APARATO.



Printed in China
JpnYN-1018/F7-3
1VMN29535★★★★★
E5SK6UD

