

Register your product and get support at
www.philips.com/welcome

BDP7520/F7
BDP7520/F8



EN User Manual

FR Manuel d'Utilisation

ES Manual del Usuario

EN: For further assistance, call the customer support service in your country.

- To obtain assistance in the U.S.A., Canada, Puerto Rico, or the U.S. Virgin Islands, contact Philips Customer Care Center at 1-866-309-0866
- To obtain assistance in Mexico, contact Philips Customer Care Center at 01 800 504 62 00

FR: Pour obtenir de l'aide supplémentaire, communiquez avec le centre de service à la clientèle de votre pays.

- Pour obtenir de l'aide aux États-Unis, au Canada, à Puerto Rico ou aux Îles Vierges américaines, communiquez avec le centre de service à la clientèle Philips au : 1-866-309-0866
- Pour obtenir l'aide au Mexique, entrez en contact avec le centre de soin de client de Philips à 01 800 504 62 00

ES: Para obtener más información, llame al servicio de soporte al cliente de su país.

- Para obtener asistencia en los Estados Unidos, en Canadá, Puerto Rico o en las Islas Vírgenes de los Estados Unidos, comuníquese con Centro de atención al cliente de Philips al 1-866-309-0866
- Solo para México CENTRO DE ATENCIÓN A CLIENTES LADA. 01 800 504 62 00 Solo Para México.

PHILIPS

PRECAUTIONS

Return your Product Registration Card or register online at www.philips.com/welcome today to get the very most from your purchase.

Registering your model with PHILIPS makes you eligible for all of the valuable benefits listed below, so don't miss out. Complete and return your Product Registration Card at once, **or register online at www.philips.com/welcome** to ensure:

*Proof of Purchase

Returning the enclosed card guarantees that your date of purchase will be on file, so no additional paperwork will be required from you to obtain warranty service.

*Product Safety Notification

By registering your product, you'll receive notification - directly from the manufacturer - in the rare case of a product recall or safety defect.

*Additional Benefits

Registering your product guarantees that you'll receive all of the privileges to which you're entitled, including special money-saving offers.

PHILIPS

Congratulations on your purchase, and welcome to the "family!"

Dear PHILIPS product owner:

Thank you for your confidence in PHILIPS. You've selected one of the best-built, best-backed products available today. We'll do everything in our power to keep you happy with your purchase for many years to come.



As a member of the PHILIPS "family," you're entitled to protection by one of the most comprehensive warranties and outstanding service networks in the industry. What's more, your purchase guarantees you'll receive all the information and special offers for which you qualify, plus easy access to accessories from our convenient home shopping network.

Most importantly, you can count on our uncompromising commitment to your total satisfaction.

All of this is our way of saying welcome - and thanks for investing in a PHILIPS product.

P.S. To get the most from your PHILIPS purchase, be sure to complete and return your Product Registration Card at once, or register online at: www.philips.com/welcome

Know these **safety** symbols

	CAUTION RISK OF ELECTRIC SHOCK DO NOT OPEN	
CAUTION: TO REDUCE THE RISK OF ELECTRIC SHOCK, DO NOT REMOVE COVER (OR BACK). NO USER-SERVICEABLE PARTS INSIDE. REFER SERVICING TO QUALIFIED SERVICE PERSONNEL.		



This "bolt of lightning" indicates uninsulated material within your unit may cause an electrical shock. For the safety of everyone in your household, please do not remove product covering.



The "exclamation point" calls attention to features for which you should read the enclosed literature closely to prevent operating and maintenance problems.

WARNING: To reduce the risk of fire or electric shock, this apparatus should not be exposed to rain or moisture, and objects filled with liquids, such as vases, should not be placed on this apparatus.

CAUTION: To prevent electric shock, match wide blade of plug to wide slot, fully insert.

ATTENTION: Pour éviter les chocs électriques, introduire la lame la plus large de la fiche dans la borne correspondante de la prise et pousser jusqu'au fond.



The symbol for CLASS II (Double Insulation)

The important note and rating are located on the rear or bottom of the cabinet.

For Customer Use

Please write the model and serial number of your unit (located on the cabinet) in the space below for future reference.

Model No. _____
Serial No. _____

PHILIPS Visit our World Wide Web Site at <http://www.philips.com/welcome>

IMPORTANT SAFETY INSTRUCTIONS

1. Read these instructions.
2. Keep these instructions.
3. Heed all warnings.
4. Follow all instructions.
5. Do not use this apparatus near water.
6. Clean only with dry cloth.
7. Do not block any ventilation openings. Install in accordance with the manufacturer's instructions.
8. Do not install near any heat sources such as radiators, heat registers, stoves, or other apparatus (including amplifiers) that produce heat.
9. Do not defeat the safety purpose of the polarized or grounding-type plug. A polarized plug has two blades with one wider than the other. A grounding type plug has two blades and a third grounding prong. The wide blade or the third prong are provided for your safety. If the provided plug does not fit into your outlet, consult an electrician for replacement of the obsolete outlet.
10. Protect the power cord from being walked on or pinched particularly at plugs, convenience receptacles, and the point where they exit from the apparatus.
11. Only use attachments/accessories specified by the manufacturer.
12. Use only with the cart, stand, tripod, bracket, or table specified by the manufacturer, or sold with the apparatus. When a cart is used, use caution when moving the cart/apparatus combination to avoid injury from tip-over.
13. Unplug this apparatus during lightning storms or when unused for long periods of time.
14. Refer all servicing to qualified service personnel. Servicing is required when the apparatus has been damaged in any way, such as power-supply cord or plug is damaged, liquid has been spilled or objects have fallen into the apparatus, the apparatus has been exposed to rain or moisture, does not operate normally, or has been dropped.



FCC WARNING

This equipment may generate or use radio frequency energy. Changes or modifications to this equipment may cause harmful interference unless the modifications are expressly approved in the manual. The user could lose the authority to operate this equipment if an unauthorized change or modification is made.

RADIO-TV INTERFERENCE

This equipment has been tested and found to comply with the limits for a Class B digital device, pursuant to Part 15 of the FCC Rules. These limits are designed to provide reasonable protection against harmful interference in a residential installation. This equipment generates, uses, and can radiate radio frequency energy and, if not installed and used in accordance with the instructions, may cause harmful interference to radio communications. However, there is no guarantee that interference will not occur in a particular installation. If this equipment does cause harmful interference to radio or television reception, which can be determined by turning the equipment off and on, the user is encouraged to try to correct the interference by one or more of the following measures:

- 1) Reorient or relocate the receiving antenna.
- 2) Increase the separation between the equipment and receiver.
- 3) Connect the equipment into an outlet on a circuit different from that to which the receiver is connected.
- 4) Consult the dealer or an experienced radio/TV technician for help.

This Class B digital apparatus complies with Canadian ICES-003.

Disconnect the mains plug to shut off when find trouble or not in use. The mains plug shall remain readily operable.

CAUTION: Danger of explosion if battery is incorrectly replaced. Replace only with the same or equivalent type.

WARNING: Batteries (Battery pack or battery installed) shall not be exposed to excessive heat such as sunshine, fire, or the like.

LASER SAFETY

This apparatus employs a laser. Only a qualified service person should remove the cover or attempt to service this apparatus, due to possible eye injury.

CAUTION: Use of controls or adjustments or performance of procedures other than those specified herein may result in hazardous radiation exposure.

CAUTION: Laser radiation when open. Do not stare into beam.

LOCATION: Inside, near the BD mechanism.

PRECAUTIONS

IMPORTANT COPYRIGHT INFORMATION

Unauthorized copying, broadcasting, public performance and lending of discs are prohibited. This item incorporates copy protection technology that is protected by U.S. patents and other intellectual property rights of Rovi Corporation. Reverse engineering and disassembly are prohibited.

Do not place the unit on the furniture that is capable of being tilted by a child and an adult leaning, pulling, standing or climbing on it. A falling unit can cause serious injury or even death.

To Avoid the Hazards of Electrical Shock and Fire

- Do not handle the AC power cord with wet hands.
- Do not pull on the AC power cord when disconnecting it from an AC outlet. Grasp it by the plug.
- Do not put your fingers or objects into the unit.

Location and Handling

- Do not install the unit in direct sunlight, near strong magnetic fields, or in a place subject to dust or strong vibration.
- Avoid a place with drastic temperature changes.
- Install the unit in a horizontal and stable position. Do not place anything directly on top or bottom of the unit. Depending on your external devices, noise or disturbance of the picture and/or sound may be generated if the unit is placed too close to them. In this case, please ensure enough space between the external devices and the unit.
- Depending on the environment, the temperature of this unit may increase slightly. This is not a malfunction.
- Be sure to remove the disc and unplug the AC power cord from the outlet before carrying the unit.

Dew Condensation Warning

- Dew condensation may form inside the unit in the following conditions. If so, do not use this unit at least for a few hours until its inside gets dry.
 - The unit is moved from a cold place to a warm place.
 - Under conditions of high humidity.
 - After heating a cold room.

Notice for Progressive Scan Output

- Consumers should note that not all high definition television sets are fully compatible with this product and may cause artifacts to be displayed in the picture. In case of picture problems with 525(480) progressive scan output, it is recommended that the user switch the connection to the 'standard definition' output. If there are questions regarding your TV set compatibility with this 525p(480p) BD/DVD player, please contact our customer service center.



ENERGY STAR® is a joint program of the U.S. Environmental Protection Agency and the U.S. Department of Energy helping us all save money and protect the environment through energy efficient products and practices.

PRECAUTIONS

Maintenance

Servicing

- Please refer to relevant topics on “TROUBLESHOOTING” on page 64 before returning the product.
- If you need to call a customer service representative, please know the model number and serial number of your product before you call. This information is displayed on the back of the product. Also, please take a moment to identify the problem you are having, and be prepared to explain this to the representative. If you believe the representative will need to help you with operations, please stay near the product. Our representatives will be happy to assist you. For online reference, please visit our web site at <http://www.philips.com/welcome>

Cleaning the Cabinet

- Wipe the front panel and other exterior surfaces of the unit with a soft cloth.
- Never use a solvent, thinner, benzene or alcohol to clean the unit. Do not spray insecticide liquid near the unit. Such chemicals may discolor the surface or damage the unit.

Cleaning Discs

- When a disc becomes dirty, clean it with a cleaning cloth. Wipe the disc from the center to out. Do not wipe in a circular motion.
- Do not use solvents such as benzine, thinner, commercially available cleaners, detergent, abrasive cleaning agents or antistatic spray intended for analog records.

Cleaning the Disc Lens

- If this unit still does not perform properly although you refer to the relevant sections and to “TROUBLESHOOTING” in this user manual, the laser optical pickup unit may be dirty. Consult your dealer or an Authorized Service Center for inspection and cleaning of the laser optical pickup unit.

Disc Handling

- Handle the discs so that fingerprints and dust do not adhere to the surfaces of the discs.
- Always store the disc in its protective case when it is not used.
- Note that discs with special shapes (heart-shaped discs, octagonal discs, etc.) cannot be played back on this unit. Do not attempt to play such discs, as they may damage the unit.

Notice

2010 © Koninklijke Philips Electronics N.V. All rights reserved.

Specifications are subject to change without notice. Trademarks are the property of Koninklijke Philips Electronics N.V. or their respective owners. Philips reserves the right to change products at any time without being obliged to adjust earlier supplies accordingly. The material in this manual is believed adequate for the intended use of the system. If the product, or its individual modules or procedures, are used for purposes other than those specified herein, confirmation of their validity and suitability must be obtained. Philips warrants that the material itself does not infringe any United States patents. No further warranty is expressed or implied. Philips cannot be held responsible neither for any errors in the content of this document nor for any problems as a result of the content in this document. Errors reported to Philips will be adapted and published on the Philips support website as soon as possible.

Warranty

No components are user serviceable. Do not open or remove covers to the inside of the product. Repairs may only be done by Philips Service Centers and official repair shops. Failure to do so shall void any warranty, stated or implied.

Any operation expressly prohibited in this manual, any adjustments, or assembly procedures not recommended or authorized in this manual shall void the warranty.

EN

Introduction

Connections

Basic Setup

Playback

Function Setup

Others

PRECAUTIONS

Important

Registering your model with Philips makes you eligible for all of the valuable benefits listed below, so don't miss out. Complete and return your Product Registration Card at once, or register online at www.philips.com/welcome to ensure :

Proof of Purchase

Returning the enclosed card guarantees that your date of purchase is on file, so no additional paperwork is required from you to obtain warranty service.

Product Safety Notification

By registering your product you receive notification - directly from the manufacturer - in the rare case of a product recall or safety defect.

Additional Benefits of Product Ownership

Registering your product guarantees that you receive all of the privileges to which you're entitled, including special money-saving offers.

For further assistance

For further assistance, call the customer support service in your country.

- To obtain assistance in the U.S.A., Canada, Puerto Rico, or the U.S. Virgin Islands, contact Philips Customer Care Center at 1-866-309-0866

Environmental Care



The packaging of this product is intended to be recycled. Contact your local authorities for information about how to recycle the packaging.

End of life directives

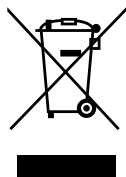

Philips pays a lot of attention to produce environment-friendly products in green focal areas. Your new Blu-ray Disc Player contains materials which can be recycled and reused. At the end of its life, specialized companies can dismantle the discarded Blu-ray Disc Player to concentrate the reusable materials and to minimize the amount of materials to be disposed of. Please ensure you dispose of your old Blu-ray Disc Player according to local regulations.

Disposal of used batteries

The batteries supplied do not contain the heavy metals mercury and cadmium. Nevertheless, in many areas batteries may not be disposed of with your household waste. Please ensure you dispose of batteries according to local regulations.

Supplied Accessories

- Remote Control
- Batteries (AAA, 1.5V x 2)
- User Manual
- Quick Start Guide
- Quick Set-up for Philips Wireless MediaConnect
- Registration card
- Box-inserts
- RCA audio / video cables

Trademark Information



Manufactured under license from Dolby Laboratories. "Dolby" and the double-D symbol are trademarks of Dolby Laboratories.



Manufactured under license under U.S. Patent #'s: 5,451,942; 5,956,674; 5,974,380; 5,978,762; 6,226,616; 6,487,535; 7,392,195; 7,272,567; 7,333,929; 7,212,872 & other U.S. and worldwide patents issued & pending. DTS and the Symbol are registered trademarks, & DTS-HD, DTS-HD Master Audio | Essential and the DTS logos are trademarks of DTS, Inc. Product includes software. © DTS, Inc. All Rights Reserved.



HDMI, the HDMI Logo, and High-Definition Multimedia Interface are trademarks or registered trademarks of HDMI Licensing LLC in the United States and other countries.

PRECAUTIONS

x.v.Color

"x.v.Color" and "x.v.Color" logo are trademarks of Sony Corporation.



Java and all Java based trademarks and logos are trademarks or registered trademarks of Oracle and/or its affiliates.



Windows Media and the Windows logo are trademarks or registered trademarks of Microsoft Corporation in the United States and/or other countries.



DivX®, DivX Certified® and associated logos are registered trademarks of DivX, Inc. and are used under license.



"AVCHD" and the "AVCHD" logo are trademarks of Panasonic Corporation and Sony Corporation.

BONUS VIEW™ "BONUSVIEW" is trademark of Blu-ray Disc Association.



"BD-Live" and "BD-Live" logo are trademarks of Blu-ray Disc Association.



DLNA®, the DLNA Logo and DLNA CERTIFIED® are trademarks, service marks, or certification marks of the Digital Living Network Alliance.

instant
streaming
ready

NETFLIX

Netflix and the Netflix logo are trademarks or registered trademarks of Netflix, Inc.



© 2010 Sonic Solutions. Roxio, CinemaNow, Roxio CinemaNow and the Roxio CinemaNow logos are trademarks or registered trademarks owned by Sonic Solutions in the United States and other jurisdictions.



BLOCKBUSTER name, design and related marks are trademarks of Blockbuster Inc.



VUDU™ is a trademark of VUDU, Inc.



"Blu-ray 3D" and "Blu-ray 3D" logo are trademarks of Blu-ray Disc Association.



"Blu-ray Disc", "Blu-ray" and "Blu-ray Disc" logo are trademarks of Blu-ray Disc Association.

DVD is a trademark of DVD Format/Logo Licensing Corporation.



Kodak and KODAK Picture CD Compatible are trademarks of Kodak used under license.



EN

Introduction

Connections

Basic Setup

Playback

Function Setup

Others

CONTENTS

Introduction

Precautions	2
Maintenance	5
Notice	5
Important	6
Supplied Accessories	6
Trademark Information	6
Features	9
Features	9
Product Info	10
Symbols Used in this User Manual	10
Functional Overview	11
Front Panel	11
Rear Panel	11
Remote Control	12
Front Panel Display	14
Guide to On-Screen Display	15

Connections

Connections	16
Connection to the TV	16
Connection to an Audio System	19
Connection to the Network	20

Basic Setup

Before You Start	22
Finding the Viewing Channel on Your TV	22

Playback

Information on Playback	23
Information on Playback	23
Guide to File List	25
How to Insert a Disc	25
Basic Playback	26
Playing Back a BD, DVD or a Disc with AVCHD Files	26
Playing Back an Audio CD or a Disc with DivX® / MP3 / Windows Media™ Audio / JPEG Files	27
Playing Back a Blu-ray 3D Disc	29
KODAK Picture CD	29
Reading the SD Memory Card	30
Playing Video / Music / Photo Files from DLNA Certified Home Media Servers	31
About DivX® and DivX® VOD	32
Playing Back DivX® with DivX® External Subtitle	33
Using the Title / Disc Menu	33
Special Playback	34
Fast Forward / Fast Reverse	34
Slow Forward Playback	34
Step by Step Playback	34
Zoom	34
Repeat Playback	35
A-B Repeat	35
Slide Show	35
PiP (BONUSVIEW) Setting	36
Enjoying BD-Live Discs with Internet	36
Title / Chapter Search	37
Track Search	37
Time Search	37
Switching Subtitles	38
Switching Audio Soundtrack	38
Switching Camera Angles	39
Philips Wireless MediaConnect	39

Netflix Operations	40
Before Activating the Connection to Netflix	40
Activating the Connection to Netflix	40
Watching Streaming Movies	40
CinemaNow / Blockbuster Operations	41
Before Activating the Connection to CinemaNow / Blockbuster	41
Activating the Connection to CinemaNow / Blockbuster	41
Guide to CinemaNow / Blockbuster Menu Screen	41
Renting or Purchasing Movies / TV episodes	42
Searching Movies / TV episodes	42
Watching Rented or Purchased Movies / TV episodes	42
VUDU Operations	43
Activating VUDU	43
Guide to VUDU Menu Screen	43
Renting or Purchasing VUDU Movies	44
Watching Rented or Purchased VUDU movies	44
Using Internet Applications	44

Function Setup

List of settings	45
Setups	52
TV Shape	52
HDMI Video Resolution	52
HDMI Audio	53
Digital Out	55
Ratings Lock	56
Network Connection	57
EasyLink (HDMI CEC)	62
Software Upgrade	62
Reset to Factory Default	63

Others

Troubleshooting	64
Downloading an Electronic Copy	66
Contact Us	66
Glossary	67
Specifications	69
Network Service Disclaimer	70
IMPORTANT HEALTH AND SAFETY INFORMATION FOR 3D TELEVISIONS	71
ONE (1) YEAR LIMITED WARRANTY	72

FEATURES

Congratulations on your purchase, and welcome to Philips!

To fully benefit from the support that Philips offers, register your product at www.philips.com/welcome.

Features

Blu-ray Disc

You can enjoy Blu-ray Disc which is capable of storing five times more data than a conventional DVD.

Playing back Blu-ray 3D Disc

This unit can play back Blu-ray 3D Discs which contain stereoscopic 3D video. In order to enjoy 3D video, connect this unit to a 3D capable TV using an HDMI 1.4 cable.

BD-Java

With some BDs which support Java applications, you can enjoy the interactive functions such as games or interactive menus.

DVD upscaling for enhanced picture quality

Your current DVD will look even better than before thanks to video upscaling. Upscaling will increase the resolution of standard definition DVD to high definition up to 1080p over an HDMI connection. The picture will be less jagged and more realistic for a near high definition experience.

Enjoy your content on different kinds of media

Full backwards compatibility with DVD, CD and SD card ensures that you can continue to enjoy your current audio-video collection. Additionally, you can enjoy AVCHD / DivX® / MP3 / WMA / JPEG files.

Listen to rich multi-channel surround sound

Multi-channel surround sound, which realizes real-to-life sound and makes you feel that you are really there.

Intuitive user interface and remote control

The Philips logical user interface allows you to easily navigate through your content and settings, so you can quickly find what you are looking for.

Easy and simple connection to your HDTV via HDMI

Connect your BDP7520 to your HDTV with one single HDMI (High Definition Multimedia Interface) cable. Philips recommends HDMI1.4 (category 2) cable (also known as High Speed HDMI cable) for better compatibility. The high definition video output signal will be transferred to your HDTV without conversion to analog signals, so you will get excellent picture and sound quality, completely free from noise. Thanks to other multiple outputs, you can also easily connect to your home theater system or amplifier.

About EasyLink (HDMI CEC) (Consumer Electronics Control)

EasyLink (HDMI CEC) allows you to operate the linked functions of this player with Philips brand TV with EasyLink feature.

Philips does not guarantee 100 % interoperability with other brands of HDMI CEC compliant devices.

PiP (BONUSVIEW)

Some BD-videos have the PiP function which enables you to display the secondary video in the primary video. You can call up the secondary video by pressing **[BONUSVIEW (PiP)]** whenever the scene contains the secondary video.

BD-Live

BD-Live (BD-ROM version 2 Profile 2.0) that allows interactive functions to be used when this unit is connected to the Internet in addition to the BONUSVIEW function. The various functions differ depending on the disc.

Pop-up menu

Some BD-videos have a pop-up menu which is a navigation menu that can be called up and be operated on the TV screen without interrupting playback. You can call up the pop-up menu by pressing **[DISC MENU / POP-UP MENU]**. Contents in the pop-up menu vary depending on the disc.

HDMI Deep Color

Deep Color reduces posterization effect of the playback image. Refer to "HDMI Deep Color" in the "LIST OF SETTINGS" on page 46.

HDMI 1080p/24 output (BD only)

This unit is equipped with the feature which can provide smooth movement during playback of film originated material with the frame rate of 24 frames per second with progressive. (Available only when the display device is connected by an HDMI cable.) Refer to "HDMI 1080p/24" in the "LIST OF SETTINGS" on page 46.

Playing back contents from an SD Memory Card

You can play back AVCHD / DivX® / MP3 / WMA / JPEGs stored in an SD Memory Card. BD-ROM Profile 2.0 (BD-Live) and Profile 1.1 discs sometimes store picture-in-picture commentary, subtitles or other extras in the SD Memory Card for use during playback with the BD-video.

Playing back AVCHD files

This unit supports playback of AVCHD format files (new format for high definition video camcorders) recorded on disc / SD card. Your high definition personal archive is playable in HD quality.

x.v.Color

This unit supports playback of video contents on discs recorded with "x.v.Color" technology. To watch this video content with the "x.v.Color" space, a TV or other display device supporting both video image reproduction using "x.v.Color" standard and capability of manual switching of its color space setting is required. Please refer to the user manual of your display device for further information.

FEATURES

Enjoy contents stored on DLNA certified home media servers

This unit is a DLNA certified media player that can play video, music and photo files stored on DLNA certified home media servers connected to your home network.

Netflix

With this unit, you can enjoy movies and TV episodes streamed instantly from Netflix via the Internet. In order to use this feature, you must visit netflix.com/Philips on your PC and become a Netflix member.

(This feature is available only in the United States.)

CinemaNow / Blockbuster

With this unit, you can enjoy movies and TV episodes streamed instantly from CinemaNow / Blockbuster via the Internet.

In order to use this feature, you must visit following website on your PC and become a CinemaNow / Blockbuster member.

- CinemaNow : www.cinemanow.com/Login

- Blockbuster : www.blockbuster.com/auth/login

VUDU

This unit supports VUDU which is the leading HD on-demand video service. With VUDU, you can also enjoy various kinds of Internet applications. In order to use this feature, you must connect this unit to the Internet.

Product Info

“Product Info” screen provides information about this unit’s hardware and software version.











You can also download the latest software from the Philips web site and upgrade it yourself if it is newer than the version currently on your unit. The current version of software on your unit can be seen on the “Product Info” screen.

To access “Product Info”, follow the procedure below.

- 1) Press [**Home**].
- 2) Use [**Up** / **Down**] to select “Settings”, then press [**OK**].
- 3) Use [**Up** / **Down**] to select “Others”, then press [**OK**].
- 4) Use [**Up** / **Down**] to select “Product Info”, then press [**OK**].

Symbols Used in this User Manual

To specify which media type each function is applicable to, we put the following symbols at the beginning of each item to operate.

Symbol	Description
	Description refers to BD-video
	Description refers to DVD-video
	Description refers to audio CD / DTS-CD
	Description refers to DVD-RW/-R and SD card with AVCHD files
	Description refers to BD-RE/-R, DVD-RW/-R, CD-RW/-R and SD card with DivX® files
	Description refers to BD-RE/-R, DVD-RW/-R, CD-RW/-R and SD card with MP3 files
	Description refers to BD-RE/-R, DVD-RW/-R, CD-RW/-R and SD card with Windows Media™ Audio files
	Description refers to BD-RE/-R, DVD-RW/-R, CD-RW/-R and SD card with JPEG files
	Description refers to video files in the DLNA home server
	Description refers to music files in the DLNA home server
	Description refers to photo files in the DLNA home server

If you do not find any of the symbols listed above under the function heading, the operation is applicable to all media.

FUNCTIONAL OVERVIEW

Front Panel

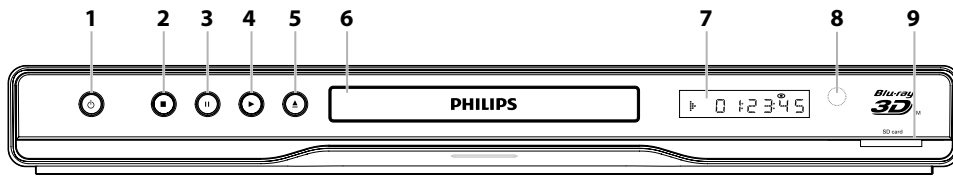

1. **⏻ (standby/on) button**

- Press to turn on the unit, or to turn the unit into the standby mode. (To completely turn off the unit, you must unplug the AC power cord.)
- Press and hold for 10 seconds to shut down the unit.
- This button lights up in red when the unit is in standby mode and turns off when the power is on.

2. **■ (stop) button**

- Press to stop playback.

3. **⏸ (pause) button**

- Press to pause playback.

4. **▶ (play) button**

- Press to start or resume playback.

5. **▲ (open/close) button**

- Press to open or close the disc tray.

6. **Disc tray**

- Place a disc after opening the disc tray.

7. **Display**

- Refer to “Front Panel Display” on page 14.

8. **Infrared sensor window**

- Receive signals from your remote control so that you can control the unit from a distance.

9. **SD card slot**

- Insert an SD Memory Card and play back the contents in it.

Note

- Due to new ENERGY STAR® requirements, this unit will automatically enter standby mode after 25 minutes of inactivity.

Rear Panel

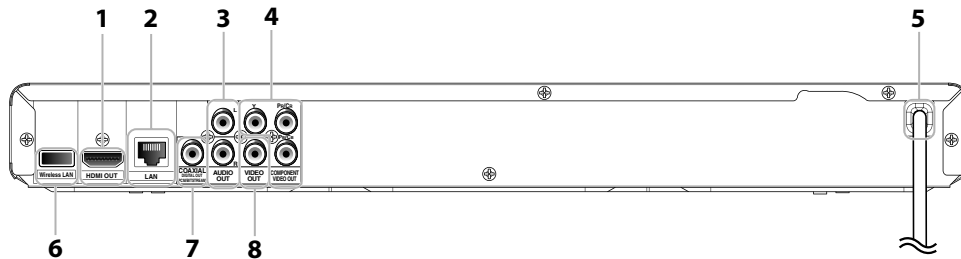

1. **HDMI OUT jack**

- Use to connect to a display with an HDMI compatible port with an HDMI cable.

2. **LAN terminal**

- Use to connect to network provisioning equipment such as a router or a modem with a LAN cable.

3. **AUDIO OUT jacks**

- Use to connect a TV monitor, an AV receiver / amplifier or other device with an RCA audio cable.

4. **COMPONENT VIDEO OUT jacks**

- Use to connect a TV monitor with component video inputs with an RCA component video cable.

5. **AC power cord**

- Connect to a standard AC outlet to supply power to this unit.
- Unplug this cord from the AC outlet to completely turn off the unit.

6. **Wireless LAN (Internal)**

7. **DIGITAL OUT (COAXIAL) jack**

- Use to connect an AV receiver / amplifier, Dolby Digital / DTS decoder or other device with a digital audio coaxial input jack with a digital audio coaxial cable.

8. **VIDEO OUT jack**

- Use to connect a TV monitor, an AV receiver / amplifier or other device with an RCA video cable.

Note

- Do not touch the inner pins of the jacks on the rear panel. Electrostatic discharge may cause permanent damage to the unit.
- This unit does not have the RF modulator.
- Do not try to rip the internal Wireless LAN from the unit.

FUNCTIONAL OVERVIEW

Remote Control

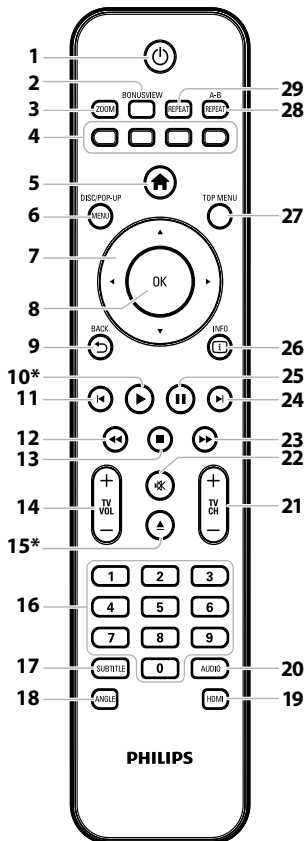

* The unit can also be turned on by pressing these buttons.

1. **⏻ (standby/on) button**

- Press to turn on the unit, or to turn the unit into the standby mode. (To completely turn off the unit, you must unplug the AC power cord.)

2. **BONUSVIEW (PiP) button**

- Press to switch picture in picture feature on/off (only applicable to BD-video which supports the PiP (BONUSVIEW) function).

3. **ZOOM button**

- Press to enlarge the picture on the TV screen.

4. **Red / Green / Blue / Yellow button**

- Press to activate short cut keys on some BD-video function.
- When file list / setup list is shown, press to switch between pages.

5. **⬆️ (home) button**

- Press to display the home menu.

6. **DISC MENU / POP-UP MENU button**

BD:

- Press to display the pop-up menu.

DVD:

- Press to display the disc menu.

7. **▲ / ▼ / ◀️ / ▶️ buttons**

- Press to select items or settings.

8. **OK button**

- Press to confirm or select menu items.

9. **⏪ (BACK) button**

- Press to return to the previously displayed menu or screen function.

10. **▶️ (play) button***

- Press to start playback or resume playback.

11. **◀️ (previous) button**

- During playback, press once to return to the beginning of the current title, chapter, track or file.
- During playback, press twice to return to the previous title, chapter, track or file.
- During the JPEG playback, press to return to the previous file.

12. **◀️ (reverse) button**

- During playback, press to fast reverse the playback.

13. **■ (stop) button**

- Press to stop playback.

14. **TV VOL + / - button**

- Press to adjust the TV volume. (Applicable to Philips TVs with EasyLink or some other devices with HDMI CEC. EasyLink has to be enabled in both devices for this function to work.)

15. **▲ (open/close) button***

- Press to open or close the disc tray.

16. **Number buttons**

- Press to select a chapter during playback.
- Press to enter values in the input field.

17. **SUBTITLE button**

- Press to select subtitles on a disc.

18. **ANGLE button**

- Press to select camera angles on a disc.
- Press to rotate a picture (JPEG).

19. **HDMI button**

- Press to set the HDMI output mode.

20. **AUDIO button**

- Press to select the audio channel (such as audio languages) on a disc.

21. **TV CH + / - button**

- Press to change the channel up and down. (Applicable to Philips TVs with EasyLink or some other devices with HDMI CEC. EasyLink has to be enabled in both devices for this function to work.)

22. **🔇 (mute) button**

- Press to mute the TV volume. (Applicable to Philips TVs with EasyLink or some other devices with HDMI CEC. EasyLink has to be enabled in both devices for this function to work.)

23. **▶️▶️ (forward) button**

- During playback, press to fast forward the playback.
- When playback is in pause, press to slow forward the playback.

24. **▶️ (next) button**

- During playback, press to skip to the next chapter, track or file.

25. **⏸️ (pause) button**

- Press to pause playback.
- When playback is in pause mode, press repeatedly to forward the playback step by step.

26. **INFO ⓘ button**

- Press to display the information display.

27. **TOP MENU button**

BD:

- Press to display the top menu.

DVD:

- Press to display the title menu.

28. **REPEAT A-B button**

- Press to play back a defined section between point A and B repeatedly.

29. **REPEAT button**

- Press to toggle between various repeat modes.

Installing the Batteries in the Remote Control

Install 2 AAA (1.5V) batteries matching the polarity indicated inside battery compartment of the remote control.

1) Open the cover.

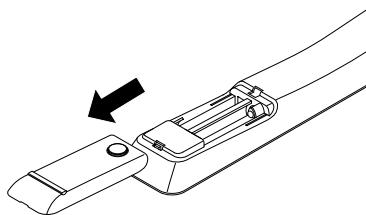

2) Insert batteries.

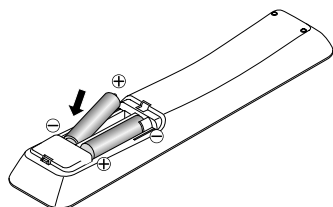

Make sure to match + and - on the batteries to the marks indicated in the battery compartment.

3) Close the cover.

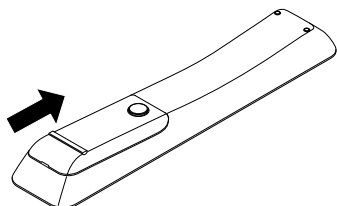

Note

Incorrect use of batteries can result in hazards such as leakage and bursting. Please observe the following:

- Do not mix new and old batteries together.
- Do not use different kinds of batteries together. Although they may look similar, different batteries may have different voltages.
- Make sure that the + and - ends of each battery match the indications in the battery compartment.
- Remove batteries from battery compartment that is not going to be used for a month or more.
- When disposing of used batteries, please comply with governmental regulations or environmental public instruction's rules that apply in your country or area.
- Do not recharge, short-circuit, heat, burn or disassemble batteries.

Using a Remote Control

Remote Control Usage Guidelines:

- Make sure that there are no obstacles between the remote control and the infrared sensor window on the unit.
- Remote operation may become unreliable if strong sunlight or fluorescent light is shining on the infrared sensor window of the unit.
- Remote control for different devices can interfere with each other. Avoid using remote control for other device located close to the unit.
- Replace the batteries when you notice a fall off in the operating range of the remote control.
- The maximum operable ranges from the unit are as follows.
 - **Line of sight:**
approx. 23 feet (7 m)
 - **Either side of the center:**
approx. 16 feet (5 m) within 30°
 - **Above:**
approx. 16 feet (5 m) within 15°
 - **Below:**
approx. 10 feet (3 m) within 30°

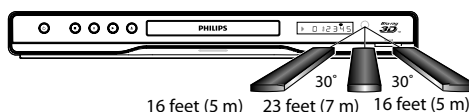

FUNCTIONAL OVERVIEW

Front Panel Display

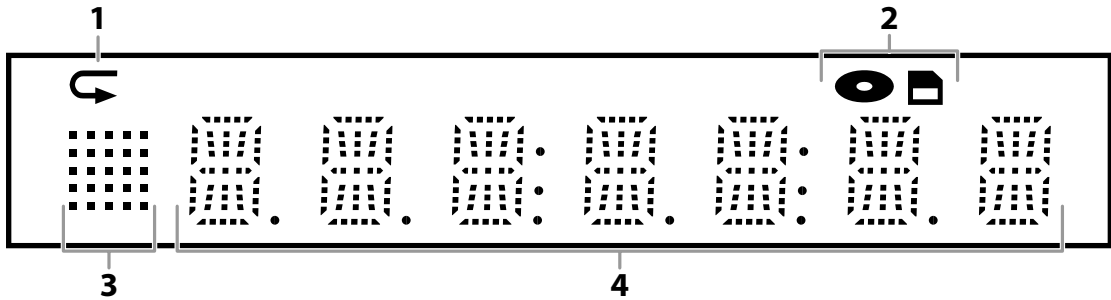

* Brightness of the display can be adjusted. Refer to "Front Panel Brightness" in "LIST OF SETTINGS" on page 50.

1. Displays repeat icon. (Appears during repeat playback.)
2. Displays media mode icon (disc mode or SD card mode).
3. Displays playback status icon. Refer to the table below.
4. Displays information such as title number, elapsed playing time, repeat type, menu type, etc.

Playback status icon	Mode
	Playback is in progress
	Stop mode
	Pause mode
	Fast forward mode
	Fast reverse mode
	Slow forward mode
	Loading

e.g.)

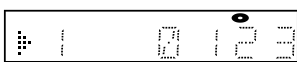

Disc is being played back.
Indicating the current title number and the elapsed time.

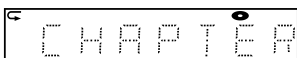

Current chapter is in chapter repeat mode during playback of disc.



Loading a disc.

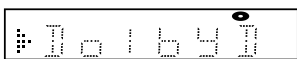

Dolby Digital audio is being played back during playback of disc.

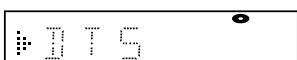

DTS audio is being played back during playback of disc.

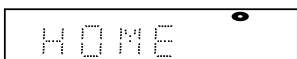

Home menu is displayed and the unit is in disc mode.

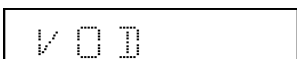

Loading VUDU.

Guide to On-Screen Display

Home Menu

When you turn on the unit, home menu will appear automatically. Otherwise, press [**⬆** (home)].



- “Play Disc”** : Initiates playback of inserted disc, displays a list of tracks / files or the media filter menu
- “SD Card”** : Displays a list of tracks / files on the inserted SD card or the media filter menu
- “Home Network”** : Displays a list of available DLNA media servers discovered on the connected network
- “Settings”** : To access settings menus
- “MediaConnect”** : To access the Philips Wireless MediaConnect menu
- “NETFLIX”** : Launches the Netflix application
- “vudu”** : Launches the VUDU App Home screen
- “BLOCKBUSTER”** : Launches the Blockbuster application
- “CinemaNow”** : Launches the CinemaNow application

Menu Screen

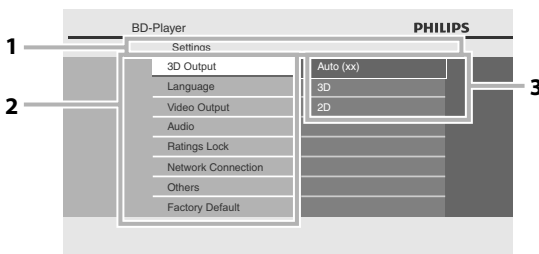

- 1. Directory**
Displays the current hierarchy.
- 2. Menus**
- 3. Options**
Displays options for the highlighted item on the left whenever available.

CONNECTIONS

Connection to the TV

- 1 Choose the appropriate connection, then proceed to the corresponding instruction (A, B or C) on the next page.

Best (Supports up to 1080i^(*1), 1080p^(*2), 1080p/24 resolution.)

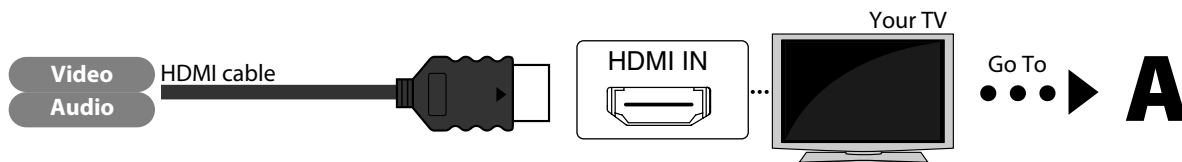

No analog audio connection required.

(*1) 1080i : Outputs the video data with frame rate of 30 frames per second.

(*2) 1080p : Outputs the video data with frame rate of 60 frames per second.

No supplied cables are used in this connection:

- Please purchase the necessary cables at your local store.
Use an HDMI cable with the HDMI logo (a certified HDMI cable) for this connection.
High Speed HDMI cable (also known as HDMI category 2 cable) is recommended for better compatibility.
- To enjoy 3D Blu-ray video, connect this unit to a 3D capable TV using an HDMI 1.4 cable.

Better (Supports up to 1080i resolution.)

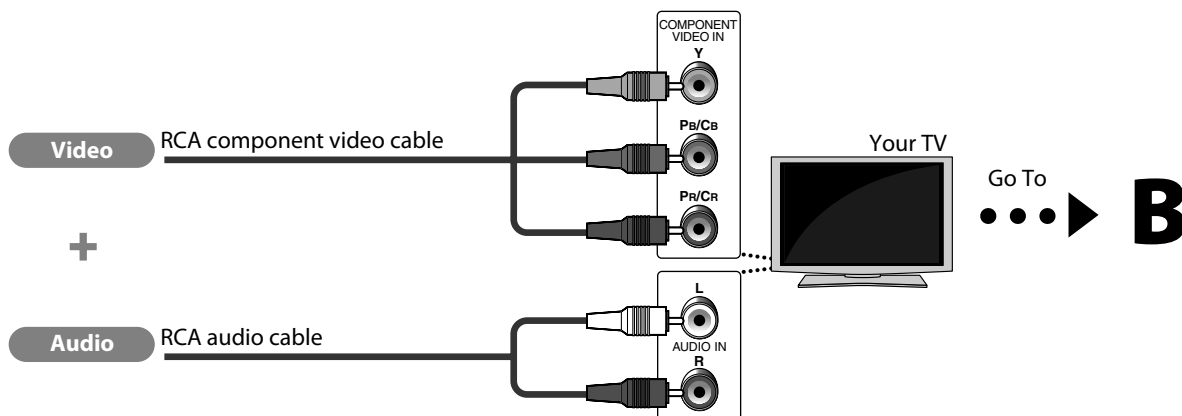

Supplied cables used in this connection are as follows:

- RCA audio cable (L/R) x 1
- Please purchase the rest of the necessary cables at your local store.

Basic (Supports only 480i resolution.)

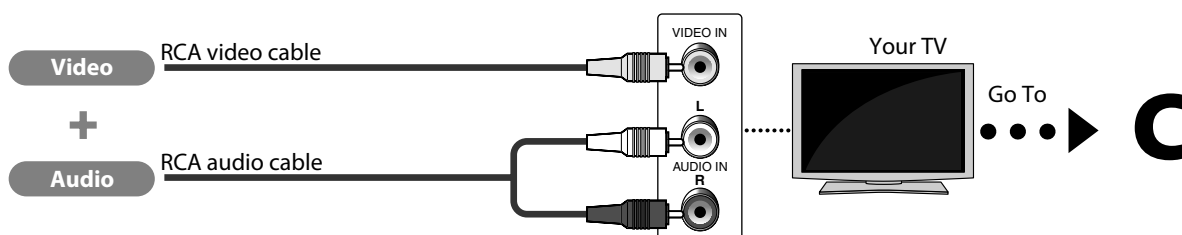

- Connect this unit directly to the TV. If the RCA audio / video cables are connected to a VCR, pictures may be distorted due to the copy right protection system.

Supplied cables used in this connection are as follows:

- RCA audio cable (L/R) x1
- RCA video cable x1

2 Connect the cables by following the descriptions below.

HDMI Video / Audio Connection

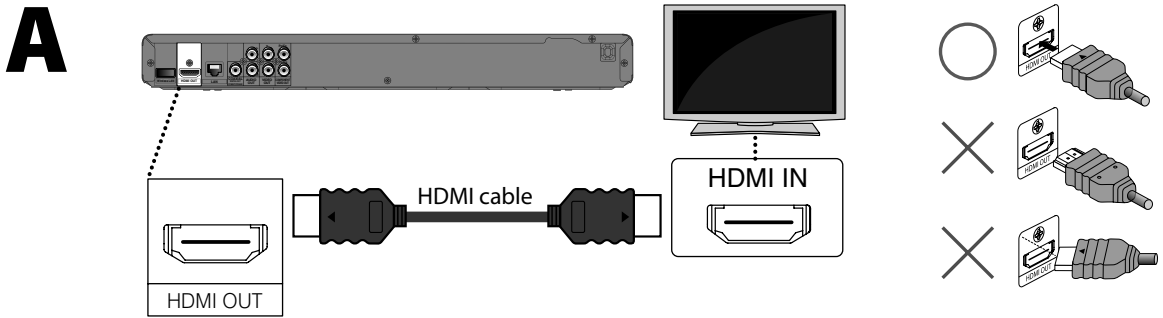

Component Video + Standard Audio Connection

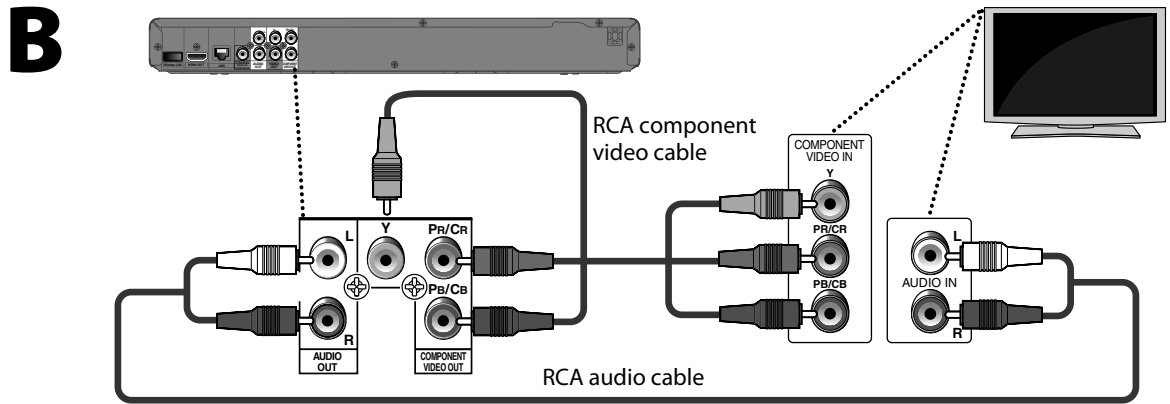

Standard Video + Standard Audio Connection

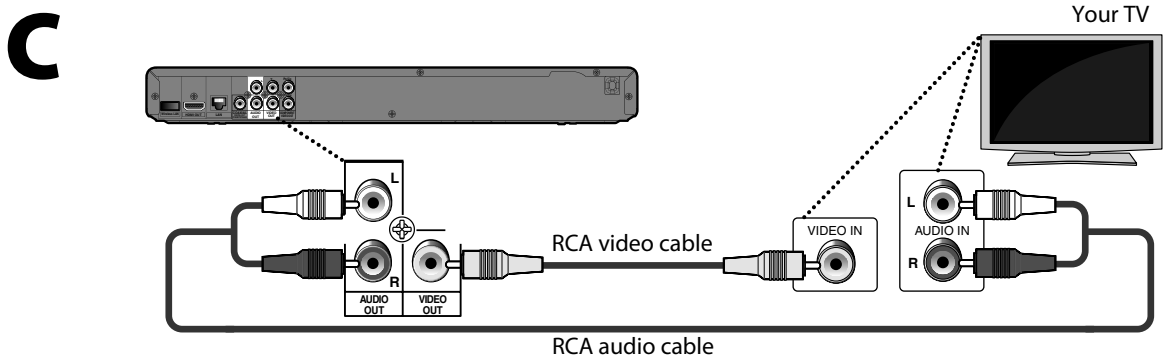

CONNECTIONS

HDMI Mode and Actual Output Signals

Press **[HDMI]** to change the resolution of the video signal being output from the HDMI OUT jack. The video resolution changes as follows every time **[HDMI]** is pressed. Or change the setting in the "HDMI Video Resolution" in the settings menu.

Font Panel Display	HDMI Video Resolution
480P	480 Progressive
Press [HDMI]	
720P	720 Progressive
Press [HDMI]	
1080I	1080 Interlaced
Press [HDMI]	
1080P	1080 Progressive
Press [HDMI]	

Copyright protection system

To play back the digital video images of a BD-video or DVD-video via an HDMI connection, it is necessary that both the player and the display device (or an AV receiver / amplifier) support a copyright protection system called HDCP (high-bandwidth digital content protection system). HDCP is copy protection technology that comprises data encryption and authentication of the connected AV device. This unit supports HDCP. Please read the operating instructions of your display device (or AV receiver / amplifier) for more information.

Note

- When connected to an HDCP incompatible display device, the picture will not be displayed properly.
- The audio signals from the HDMI jack (including the sampling frequency, the number of channels and bit length) may be limited by the device that is connected.
- Among the display device(s) that support HDMI, some do not support audio output (for example, projectors). While connected to a device such as a projector, audio will not be output from the HDMI OUT jack.
- When this unit's HDMI jack is connected to a DVI-D compatible display device(s) (HDCP compatible) with an HDMI-DVI converter cable, the signals are output in digital RGB.
- Pressing **[HDMI]** does not work when HDMI cable is not connected, or when no video signal is being output from the HDMI OUT jack.
- Pressing **[HDMI]** does not work during the playback of a BD-video.
- When you make a selection, the TV monitor temporarily goes blank and then comes back again. If it does not, press **[HDMI]** repeatedly to change the resolution or press and hold **[▶ (play)]** on the front panel for 5 seconds to change the setting back to its default.

CONNECTIONS

Connection to an Audio System

- When you change the connections, all devices should be turned off.
- Refer to the manual accompanying external devices for more information.

2-Channel Analog Audio Connection

Digital Audio Connection

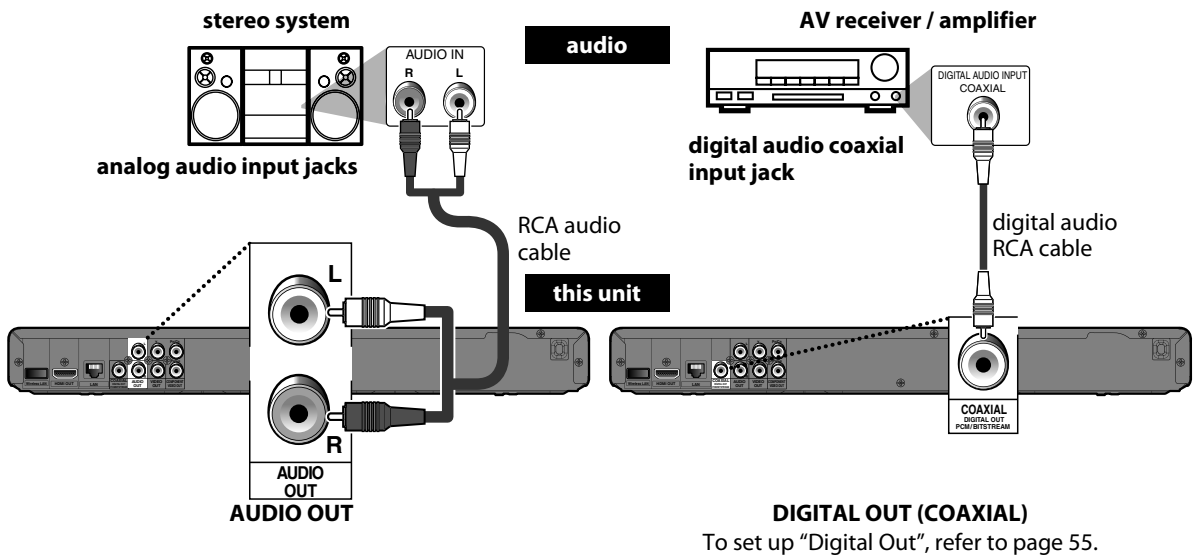

Audio Output from Analog Out (2ch Jacks)

Media ↓	"Blu-ray Disc Audio" setting → Audio Source ↓	"Primary Audio Only"	"Mix Audio Output"
	BD-video	Dolby Digital	DownMix 2ch PCM
Dolby Digital Plus		DownMix 2ch PCM ^{*1}	DownMix 2ch PCM ^{*2}
Dolby TrueHD		DownMix 2ch PCM ^{*3}	DownMix 2ch PCM ^{*4}
DTS [®]		DownMix 2ch PCM	DownMix 2ch PCM
DTS-HD [®]		DownMix 2ch PCM ^{*1}	DownMix 2ch PCM ^{*5}
LPCM		DownMix 2ch PCM	DownMix 2ch PCM
DVD-video	Dolby Digital	DownMix 2ch PCM	
	DTS [®]	DownMix 2ch PCM	
	LPCM	2ch PCM	
DTS-CD	DTS [®]	DownMix 2ch PCM	
AVCHD	Dolby Digital	DownMix 2ch PCM	
	LPCM	DownMix 2ch PCM	
DivX [®]	Dolby Digital	DownMix 2ch PCM	
	MP3 / MP2	2ch PCM	
Audio CD	PCM	2ch PCM	
MP3	MP3	2ch PCM	
Windows Media™ Audio	WMA	2ch PCM	
DLNA Video	Dolby Digital	DownMix 2ch PCM	
	MP2	2ch PCM	
	LPCM	2ch PCM	
DLNA Music	MP3 / WMA / LPCM	2ch PCM	
Netflix	WMA	2ch PCM	
CinemaNow	AAC	2ch PCM	
Blockbuster	AAC	2ch PCM	
VUDU	Dolby Digital Plus	DownMix 2ch PCM ^{*1}	DownMix 2ch PCM ^{*2}
	MP3	2ch PCM	

*1) Full decoded.

*2) Only the independent substream is decoded.

*3) Dolby TrueHD stream is decoded.

*4) Only the Dolby Digital substream is decoded.

*5) Only the core substream is decoded.

CONNECTIONS

HDMI Audio Connection

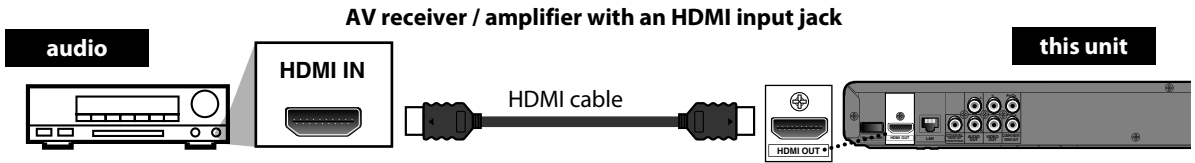

To set up "HDMI Audio", refer to page 53.

Supplied cables used in these connections are as follows:

- RCA audio cable (L/R) x 1
- Please purchase the rest of the necessary cables at your local store.

Connection to the Network

By connecting this unit to the Internet, you can upgrade the software via the Internet, play contents stored on DLNA home media servers or access BD-Live, Netflix, CinemaNow, Blockbuster and VUDU services.

- For more information about software upgrade, refer to "Network Upgrade" on page 62.
- For more information about DLNA, refer to "Playing Video / Music / Photo Files from DLNA Certified Home Media Servers" on page 31.
- For more information about BD-Live, refer to "Enjoying BD-Live Discs with Internet" on page 36.
- For more information about Netflix, refer to "NETFLIX OPERATIONS" on page 40.
- For more information about CinemaNow and Blockbuster, refer to "CINEMANOW / BLOCKBUSTER OPERATIONS" on page 41.
- For more information about VUDU, refer to "VUDU OPERATIONS" on page 43.

Note

- Wired connection is recommended when using following features.
(Using following features with wireless connection can be affected by other devices using radio frequencies.)
 - Play contents from DLNA certified home media servers
 - Video streaming services (Netflix / CinemaNow / Blockbuster / VUDU)
 - Network upgrade

Wired Connection

Make the following connection if you are using a wired router.

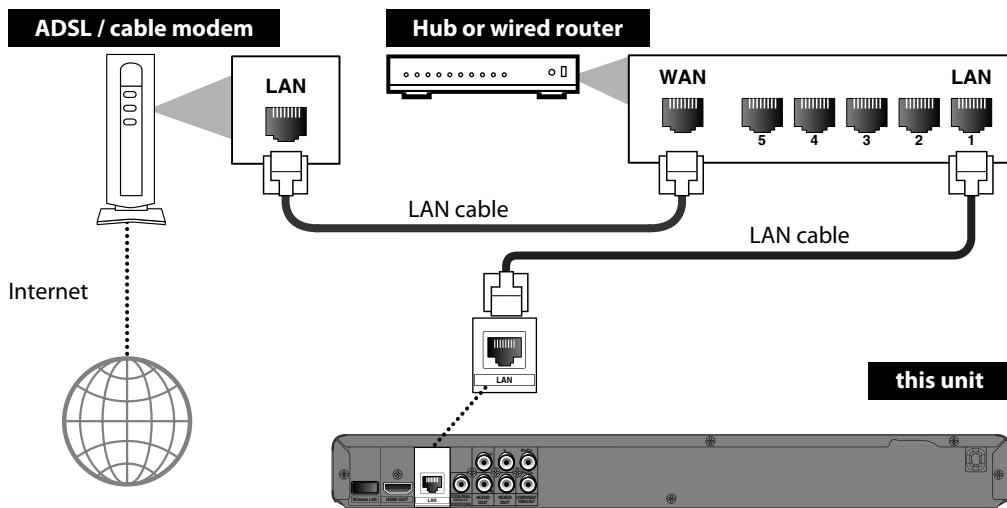

No supplied cables are used in this connection:

Please purchase the necessary cables at your local store.

Note

- After you made a wired connection, set up necessary network settings.
(For the network setting of wired connection, refer to “Wired Connection” on page 57.)
- Do not insert any cable other than a LAN cable to the LAN terminal to avoid damaging the unit.
- If your modem does not have router functions, connect a wired router.
- If your modem has router functions but there is no vacant port, use a hub.
- For a wired router, use a router which supports 10BASE-T / 100BASE-TX.
- Do not connect your PC directly to the LAN terminal of this unit.
- Please purchase shielded LAN cables at your local store and use them when you connect to network equipment.

Wireless Connection

Make the following connection if you are using a wireless router.

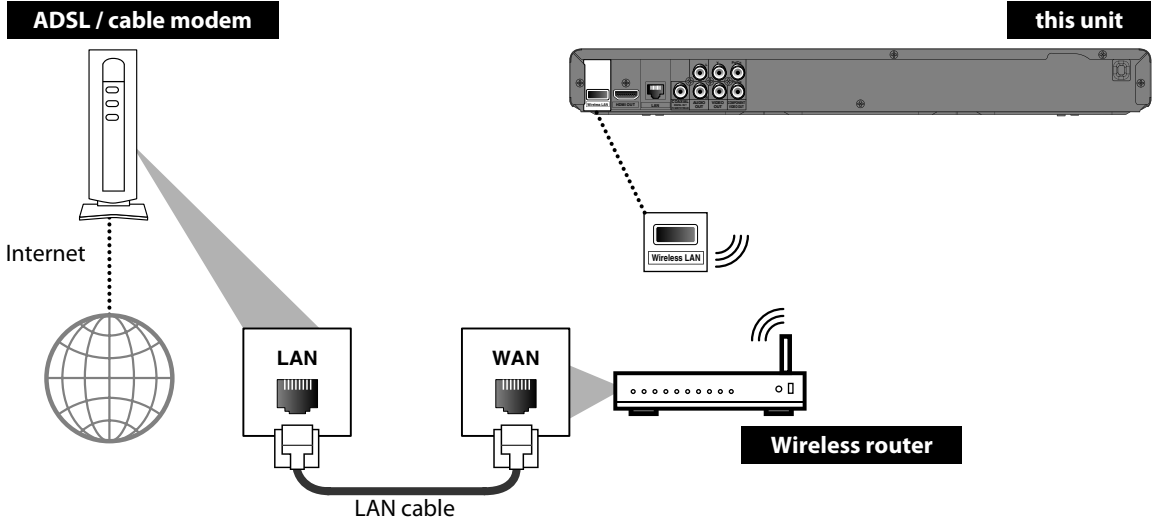

No supplied cables are used in this connection:
Please purchase the necessary cables at your local store.

Note

- After you made the wireless connection, set up necessary network settings.
(For the network setting of wireless connection, refer to “Wireless Connection” on page 60.)
- For a wireless router, use a router which supports IEEE 802.11 b/g/n.
(n is recommended for stable operation of the wireless network.)
- Set the wireless router to Infrastructure mode. This unit does not support Ad-hoc mode.
- Other radio devices or obstacles may cause interference to the wireless network connection.

BEFORE YOU START

After you have completed all the connections, you must find the viewing channel (external input channel) on your TV.

Finding the Viewing Channel on Your TV

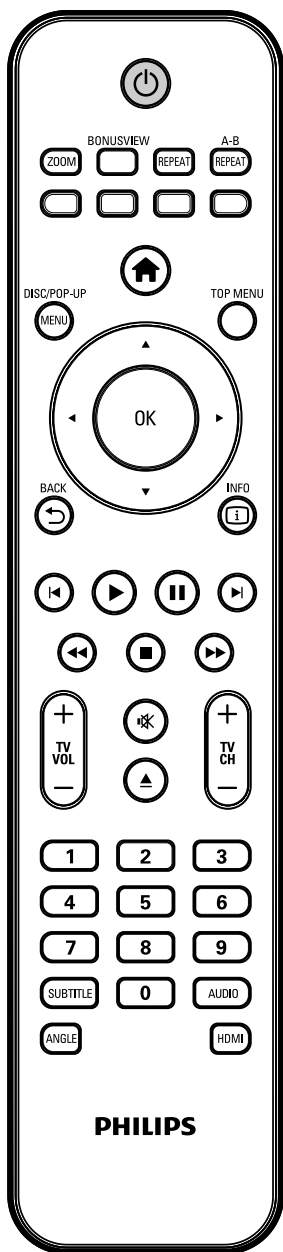

- 1** After you have made all the necessary connections, press $\text{[} \text{⏻} \text{ (standby/on)]}$ to turn on the unit.
- 2** Turn on your TV.
- 3** Press the button on the TV's remote control that accesses the external input channel. It may be labeled "SOURCE", "AV" or "SELECT" (refer to your TV's user manual). Or press "2" on the TV's remote control, then press channel down button repeatedly until you see the PHILIPS splash screen.

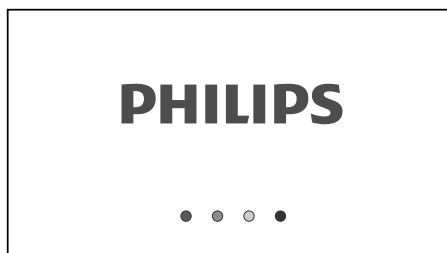

This is the correct viewing channel (external input channel).

- If a certain amount of time has passed since you turned on the unit, you may see the home menu instead of the PHILIPS splash screen.

Home menu:



INFORMATION ON PLAYBACK

Information on Playback

Before you start playing back a disc, read the following information.

Playable Discs and Files

This unit is compatible to play back the following discs / files. To play back a disc / file, make sure that it meets the requirements for region codes and color systems as described below. You can play back discs that have the following logos. Other disc types are not guaranteed to play back.

Playable discs	Logos
Blu-ray Disc - BD-video - Blu-ray 3D Disc - Blu-ray 3D only Disc - BD-RE* (ver. 2.1) (Recorded in BDMV format) - BD-R* (ver. 1.1 / 1.2 / 1.3) (Recorded in BDMV format) (Unclosed discs may not be played back.)	 
DVD-video	
DVD-RW (finalized video mode discs only)	
DVD-R (finalized video mode discs only)	
CD-DA (audio CD)	
CD-RW	
CD-R	
KODAK Picture CD	
DTS-CD	-

(*) Due to the intentional progression of the Blu-ray Disc format by its standard setting authority, the company cannot guarantee or warrant the playability of future extensions of the Blu-ray Disc format with this product.

Playable files	Media
AVCHD	DVD-RW/-R SD Memory Card (including SDHC) miniSD Card microSD Card
DivX®	BD-RE/-R
MP3	DVD-RW/-R CD-RW/-R
Windows Media™ Audio	SD Memory Card (including SDHC) miniSD Card
JPEG	microSD Card

- ABOUT DIVX VIDEO: DivX® is a digital video format created by DivX, Inc. This is an official DivX Certified device that plays DivX video. Visit www.divx.com for more information and software tools to convert your files into DivX video.
- ABOUT DIVX VIDEO-ON-DEMAND: This DivX Certified® device must be registered in order to play DivX Video-on-Demand (VOD) content. To generate the registration code, locate the DivX VOD section in the device setup menu. Go to vod.divx.com with this code to complete the registration process and learn more about DivX VOD.
- DivX Certified® to play DivX® video up to HD 1080p, including premium content.
- Discs containing the DivX® files with the DivX® GMC (Global Motion Compensation) playback feature, which is DivX® supplemental function, cannot be played back on this unit.
- This unit cannot play back the disc contents protected by Windows Media™ Digital Rights Management (DRM).

Readable cards	Playable files / data
SD Memory Card (8 MB - 2 GB)	AVCHD, DivX®, MP3, WMA,
SDHC Memory Card (4 GB - 8 GB)	JPEG, picture-in-picture
miniSD Card (8 MB - 2 GB)	commentary, subtitles or
microSD Card (8 MB - 2 GB)	other extras for BD-ROM
	ver. 2 (Profile 2.0 / Profile 1.1)

Note for SD Memory Cards

- This unit supports SD Memory Card with FAT12 / FAT16 file system, and SDHC Memory Card with FAT32 file system.
- This unit does not support NTFS file system.
- This unit may not read SD Memory Cards formatted on a computer. If that is the case, please reformat the SD Memory Cards in this unit and try again.
- This unit does not support miniSDHC and microSDHC Memory Card.
- For miniSD Card and microSD Card, an adapter is necessary.

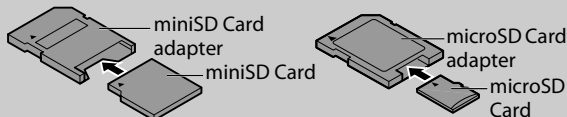

- Portions of this product are protected under copyright law and are provided under license by ARIS / SOLANA / 4C.
- Please keep the SD Memory Cards in their cases when you are not using them.
- Do not try to open or modify the card.
- Do not touch the terminal surface with your fingers or any metals.
- Do not attach additional labels or stickers to cards.
- Do not remove the label of the SD Memory Cards.
- This unit recognizes up to 8 characters of file name in the SD Memory Card. Characters after 8th will not be displayed.

INFORMATION ON PLAYBACK

Unplayable Discs and Files

The following discs will not be played back in this unit.

- CD-ROM
- DVD-RAM
- DVD-audio
- HD DVD
- unfinalized disc
- BD-RE (ver.1.0)
- BD-RE (ver.2.1) (Recorded in BDAV format)
- BD-R (ver.1.1 / 1.2 / 1.3) (Recorded in BDAV format)
- BD that contains AVCHD files
- BD / DVD hybrid disc (played back as a BD-video only)
- Super Audio CD - Only the sound on the CD layer can be heard. The sound on the high-density Super Audio CD layer cannot be heard.
- Playability of dual discs are not guaranteed.
- CD-I (compact disc-interactive)
- VSD (video single disc)
- video CD
- SVCD

Color Systems

BD-video and DVD-video are recorded in different color systems throughout the world. The most common color system is NTSC (which is used primarily in the United States and Canada).

This unit employs NTSC color system, so the disc you play back must be recorded in the NTSC system. You cannot play back the disc recorded in other color systems.

Region Codes

This unit has been designed to play back BD-video with region "A", DVD-video with region "ALL" or "1" for BDP7520/F7 (USA / Canada) and region "ALL" or "4" for BDP7520/F8 (Mexico). You cannot play back BD-video or DVD-video that are labeled for other regions. Look for the symbols on the right on your BD-video or DVD-video.

If these region symbols do not appear on your BD-video or DVD-video, you cannot play back the disc in this unit. The letter or number inside the globe refers to region of the world. A BD-video or DVD-video labeled for a specific region can only be played back in the unit with the same region code.

BD-video



DVD-video



For BDP7520/F7
(USA / Canada)



For BDP7520/F8
(Mexico)







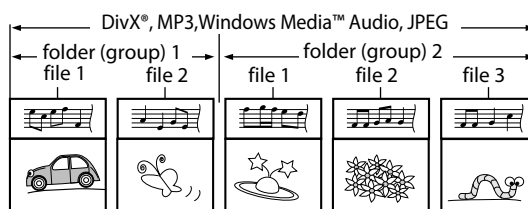
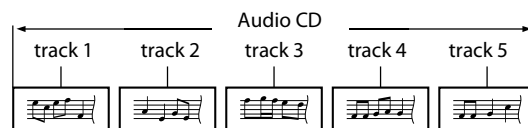
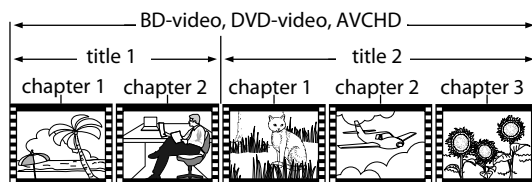



Hint for Disc Playback

The contents of disc are generally divided into sections or folders (groups of titles / files) as shown below.



Description for Icons

- [] : group (folder) icon
- [] : group (folder) return icon
- [] : video file icon
- [] : music file icon
- [] : photo file icon
- [] : information icon
- [] : key icon
- [] : signal icon
- "Folders" refers to the groups of files.
- "Tracks" refers to the contents recorded on the audio CD.
- "Files" refers to the contents on a disc which are recorded in DivX®, MP3, Windows Media™ Audio, JPEG file format.

Note

- Unrecognizable characters will be replaced by "□".
- For BD, DVD and SD card, this unit can recognize up to 999 groups (folders), and 9,999 tracks / files.
- For CD, this unit can recognize up to 255 groups (folders), and 999 tracks / files.

Guide to File List

Audio CD Track List

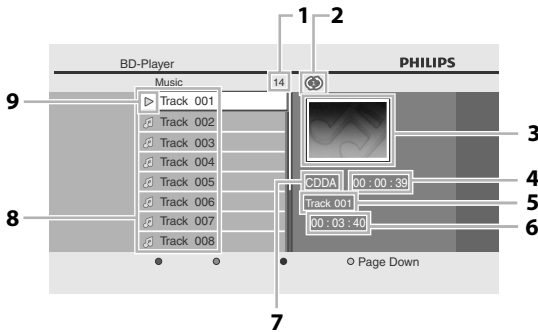

- 1) Total track number
- 2) Repeat status
- 3) Image
- 4) Elapsed playing time of the current track
- 5) Playing track number
- 6) Total time of the current track
- 7) Playing media
- 8) Track list
- 9) Playback status

Video / Music Mode File List

e.g.) MP3 mode

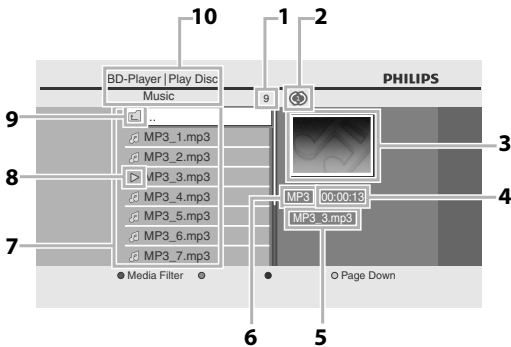

- 1) Number of contents in the current hierarchy
- 2) Repeat status (Music mode only)
- 3) Image
- 4) Elapsed playing time of the current track
- 5) Current file name
- 6) Media type
- 7) Group (folder) / File list
- 8) Playback status
- 9) Root folder
- 10) Directory

Picture Mode File List

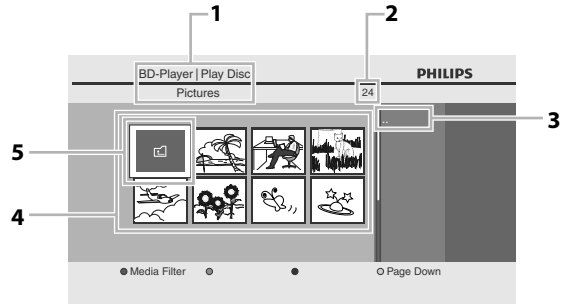

- 1) Directory
- 2) Number of contents in the current hierarchy
- 3) Current file name
- 4) Group (folder) / File list (thumbnails)
- 5) Root folder

How to Insert a Disc

- 1) Press [**▲** (open/close)] to open the disc tray.
- 2) Place the disc on the disc tray with its label side facing up.

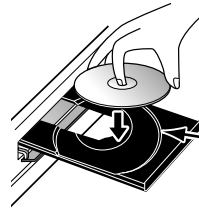

Align the disc to the disc tray guide.

* Make sure the disc is compatible with this unit (refer to page 23 for the list of compatible discs).

- 3) Press [**▲** (open/close)] to close the disc tray.

It may take a while to load the disc.

To eject the disc:

Press [**▲** (open/close)] to open the disc tray.
Remove the disc.
Press [**▲** (open/close)] to close the disc tray.

BASIC PLAYBACK

Playing Back a BD, DVD or a Disc with AVCHD Files

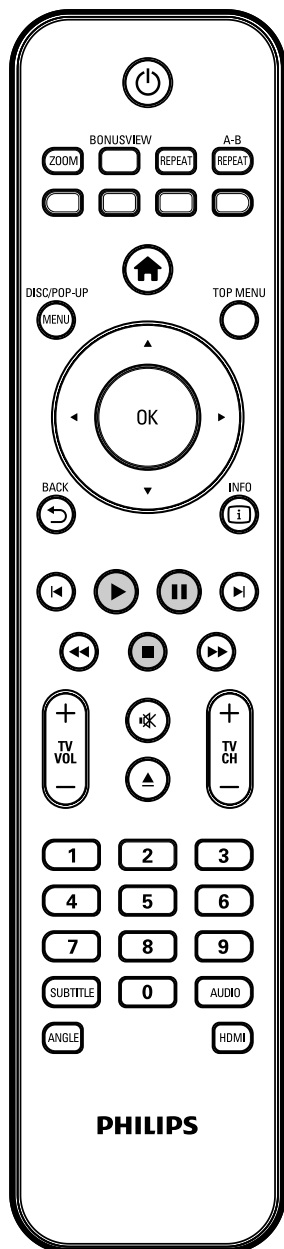

1 Insert a disc (refer to “How to Insert a Disc” on page 25).

2 Playback may start automatically.
If not, press **[▶ (play)]**.
Some discs may show a title or a disc menu. In this case, refer to “Using the Title / Disc Menu” on page 33.

To pause playback:

Press **[⏸ (pause)]**.

To return to the normal playback:

Press **[▶ (play)]**.

To stop playback:

Press **[■ (stop)]**.

Playback will be in Resume-On-Stop mode, and the home menu will appear.

<Resume-On-Stop mode>

When you press **[▶ (play)]** next time, the playback will start from the point where it has been stopped.

Note

- Playback will also stop and the home menu will appear when you press **[⬆ (home)]**.
- For BD-Java application, the Resume-On-Stop may not be available.
- If you press **[OK]** instead of **[▶ (play)]**, playback can be started from the beginning of the disc even if it was in the Resume-On-Stop mode.
- You can also start from the beginning of the disc if you press **[◀ (previous)]** while the resume message is displayed.
- The resume message can be removed by pressing **[BACK ↶]**.
- Resume-On-Stop mode remains in effect even after power is turned off, but will be cancelled once the disc is ejected.
- If you change “3D Output” setting to “2D” while the unit is in the Resume-On-Stop mode of Blu-ray 3D Disc playback, the resume information will be cleared.

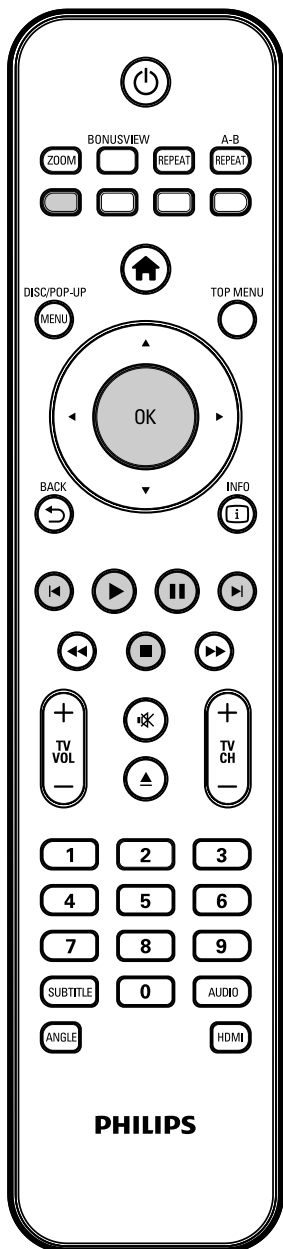

How to Navigate through the Track / File List

- Use [▲ / ▼] to move the highlight up and down in the list.
- To access the files in a group (folder), select the desired group (folder), then press [OK].
- Press [◀], or select [⏪], then press [OK] to go back to the previous hierarchy.
- Press [◀] to go back to the previous screen.
- Press [Blue] or [Yellow] to change the page of the list.
- Press [Red] to go back to the media filter screen.
- Press [⏪ (home)] to go back to the home menu.

Recommended specifications:

DivX®

Official DivX® Certified product

- Playable codec of AVI files : DivX® 3.x, DivX® 4.x, DivX® 5.x, DivX® 6.x
- Maximum size of a video : 1920 x 1080 @60 fps
- Sampling frequency of audio : 16 kHz - 48 kHz
- Audio type : MPEG1 audio layer 3(MP3), MPEG1 audio layer 2, Dolby Digital

MP3 / Windows Media™ Audio

- Sampling frequency : 32 kHz, 44.1 kHz or 48 kHz
- Constant bit rate : 112 kbps - 320 kbps (MP3), 48 kbps - 192 kbps (Windows Media™ Audio)

JPEG

Resolution

- Upper limit : 2,560 x 1,900 dots (sub sampling is 4:4:4)
: 5,120 x 3,840 dots (sub sampling is up to 4:2:2)
- Lower limit : 32 x 32 dots
- Maximum file size of a picture : 5 MB

Folder / File number limitations:

BD, DVD and SD card

- 999 folders (groups) and 9,999 files.

CD

- 255 folders (groups) and 999 tracks / files.

1 Insert a disc (refer to “How to Insert a Disc” on page 25).

- Home menu appears automatically.

2 With “Play Disc” selected, press [OK].

- Media filter screen will appear.
- For audio CD, skip to step 4.



3 Select the type of the file you want to play back in the media filter screen. Then press [OK] to display the file list.

- “Video”** : If you want to play back video files such as DivX® video, select “Video”.
- “Music”** : If you want to play back music files such as MP3 or Windows Media™ Audio, select “Music”.
- “Pictures”** : If you want to play back the still images such as JPEG pictures, select “Pictures”.

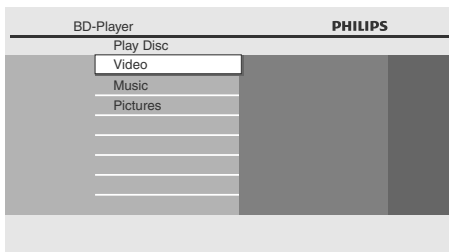

4 Select a group (folder) or track / file you want to play back. Then press [▶ (play)] or [OK] to start playback.

Refer to “How to Navigate through the Track / File List” on page 27.

To skip to the next track / file:

Press [▶] (next).

To skip to the previous track / file:

Press [◀] (previous).

To pause playback:

Press [⏸] (pause).

To return to the normal playback:

Press [▶] (play).

To stop playback:

Press [■] (stop).

Playback will be in Resume-On-Stop mode.

<Resume-On-Stop mode for **audio CD / DivX®** >

Playback will start from the point where it is stopped next time you press [▶] (play).

If you press [OK] instead of [▶] (play), playback will start from the beginning of the track / file instead of resuming from the stop point.

<Resume-On-Stop mode for **MP3 / Windows Media™ Audio / JPEG**>

Playback will start from the beginning of the current file next time you press [▶] (play) or [OK].

To go back to the media filter screen:

Press [Red] in Resume-On-Stop mode.

Note

- Playback will also stop and the home menu will appear when you press [⬆] (home).
- If a disc contains AVCHD files, the playback of other files on the same disc is not available. All files on an SD Memory Card are available.
- With regard to the multi-border BD-RE/-R, additionally recorded sections cannot be recognized.
- With regard to the multi-border DVD-RW/-R, additionally recorded sections may not be recognized.

Playing Back a Blu-ray 3D Disc



This unit can play back Blu-ray 3D Disc which contains stereoscopic 3D video. In order to view 3D Blu-ray videos, you need to have the following:

- 3D capable TV
- HDMI 1.4 cable
- 3D glasses
- Blu-ray 3D Disc or Blu-ray 3D only Disc

1 Connect 3D capable TV with HDMI 1.4 cable.

- Refer to "Connection to the TV" on page 16.

2 Insert a Blu-ray 3D Disc or a Blu-ray 3D only Disc.

- Refer to "How to Insert a Disc" on page 25.

3 Follow step 2 in "Playing Back a BD, DVD or a Disc with AVCHD Files" on page 26.

Caution

- Watching 3D videos may cause headache, dizziness or tiredness.
To avoid such consequences, do not watch 3D videos for a long period of time.
- Watching 3D videos is not recommended for the following people:
 - People who are susceptible to motion sickness
 - Children from walking age to seven years
 - Pregnant woman

For more information, refer to "IMPORTANT HEALTH AND SAFETY INFORMATION FOR 3D TELEVISIONS" on page 71.

Note

- For more information, refer to the 3D TV's manual.
- When "3D Output" is set to "Auto (XX)" and your TV is not 3D capable, playback of Blu-ray 3D Discs will revert to 2D depending on the disc.
- You can turn off 3D output mode by setting "3D Output" to "2D". (Refer to page 45.)
- For Blu-ray 3D only Discs, playback in 2D mode is not possible.
- You can check the current output mode (2D or 3D) by pressing [INFO] during playback.

KODAK Picture CD

JPEG

This unit can also run JPEG files stored on KODAK Picture CD. You can enjoy picture images on the TV set by playing back the KODAK Picture CD. This unit conforms to ver.7.0 of KODAK Picture CD. For details of KODAK Picture CD, contact a shop that provides developing service of Kodak Inc.

1 Insert a KODAK Picture CD.

- Home menu appears automatically.

2 With "Play Disc" selected, press [OK].

- Media filter screen will appear.

3 Select "Pictures" in the media filter screen. Then press [OK] to display the file list.

4 Follow step 4 in "Playing Back an Audio CD or a Disc with DivX® / MP3 / Windows Media™ Audio / JPEG Files" on pages 27-28.

Tips for JPEG / KODAK Picture CD Playback

- Every press on [ANGLE] will turn the image clockwise by 90 degrees when an image is displayed.

Note

- Some unplayable folders or files may be listed due to the recording status.
- High-resolution JPEG files take longer to be displayed.
- Progressive JPEG files (JPEG files saved in progressive format) cannot be played back in this unit.

BASIC PLAYBACK

Reading the SD Memory Card

AVCHD

DivX

MP3

WINDOWS
MEDIA
AUDIO

JPEG

You can play back the AVCHD / DivX® / MP3 / WMA / JPEG files in an SD Memory Card. With the SD Memory Card, you can also enjoy the following functions.

- Special additional contents for BD-ROM Profile 1 ver.1.1. (For more information about the special additional contents, refer to the instruction book that came with the disc.)
- BD-Live function (BD-ROM ver. 2 Profile 2.0). (For more information about BD-Live, refer to page 36.)

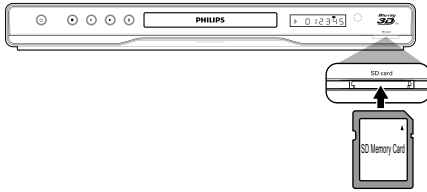

1 Insert an SD card and then press [▲ (home)].

Home menu appears.

2 With "SD Card" selected, press [OK].

- Media filter screen will appear.

3 Select the type of the file you want to play back in the media filter screen. Then press [OK] to display the file list.

For "Video":

- If the SD Memory Card contains AVCHD and DivX® files, use [▲ / ▼] to select "AVCHD" or "DivX", then press [OK].
- If the SD Memory Card contains AVCHD files and no DivX® files, the playback will start right after you select "Video". (The file list is not available for AVCHD files.)

4 Follow step 4 in "Playing Back an Audio CD or a Disc with DivX® / MP3 / Windows Media™ Audio / JPEG Files" on pages 27-28.

To remove the SD Memory Card:

In stop mode, gently push in the SD Memory Card, then pull it out slowly.

Note

- In the "SD Card" mode, the resume information will be cleared when;
 - [■ (stop)] is pressed while in the Resume-On-Stop mode.
 - the SD Memory Card is removed.
 - the unit is turned into the standby mode.
- Do not remove the SD Memory Card or turn the unit to the standby mode while the contents of the card are in playback. It may result in malfunction or loss of the card's data.
- Do not delete the folders or files in the SD Memory Card with your computer. This unit may not read SD Memory Cards formatted on a computer.
- If a folder or file name includes one of the following unrecognizable characters, the folder or file name may not be displayed correctly.
 - Unrecognizable characters: ., " = + [] ; / \ : | ¥
- Playback of DivX® files in an SD Memory Card is not guaranteed.

Playing Video / Music / Photo Files from DLNA Certified Home Media Servers



On this unit, you can play video, music and photo files stored on DLNA certified home media servers connected to your home network. In order to use this feature, you must connect this unit to the Internet.

1 Connect this unit to the Internet.
 • Refer to "Connection to the Network" on page 20.

2 Set up the necessary network connection settings.
 • Refer to "Network Connection" on page 57.

3 Start DLNA home media servers in your home network.
 • For details, refer to the user manual of the DLNA certified device.

4 Press [↑ (home)] to access the home menu.

5 With "Home Network" selected, press [OK].
 • This unit will start loading the home server list.
 • To cancel loading, press [■ (stop)].
 • To reload the home server list, press [Green].

6 After loading, home server list will appear. Select a home server you want to access, then press [OK].

7 File list of the selected home server will appear. Select a file you want to play back, then press [▶ (play)] or [OK] to start playback.

- If you select a folder, select a file in the folder and then press [▶ (play)] or [OK] to start playback.

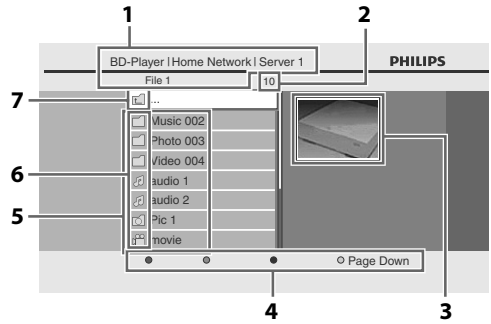

- 1) Directory
- 2) Number of contents in the current hierarchy
- 3) Icon of the current home server
- 4) Color key (Red / Green / Blue / Yellow button) guide
- 5) Group (folder) / file list
- 6) Folder / media icon
- 7) Root folder (go back to the previous hierarchy)

- To control the playback, use following buttons.

Button	Action
◀ (previous) / ▶ (next)	Skip to the previous / next file during playback or in pause mode
⏸ (pause)	Pause the playback
▶ (play)	Return to the normal playback
■ (stop)	Stop the playback (For video files, playback will be in Resume-On-Stop mode.) <Resume-On-Stop mode for video files> Playback will start from the point where it is stopped next time you press [▶ (play)]. If you press [OK] instead of [▶ (play)], playback will start from the beginning of the file instead of resuming from the stop point.

BASIC PLAYBACK

Note

- For the home server list, maximum of 10 servers can be displayed.
- The system can recognize up to 9,999 files (including folders).
- The 10th and deeper hierarchies cannot be displayed.
- This unit supports following formats. (Formats other than listed below cannot be recognized.)
 - Video : MPEG 1
MPEG 2 PS
MPEG 2 TS / TTS
 - Music : LPCM
MP3
WMA
 - Photo : JPEG
- Unplayable files in the home server will not be displayed in the file list.
- For some files, playback is not available even if displayed in the file list.
- In order to play back the contents in home servers, the player and the servers must be connected to the same access point.
- Compatibility and available playback function may differ depending on the home server.
- If you select a photo file in step 7 on page 31, the selected file will be played back and go to the next file in the current hierarchy in turn every 10 seconds.
- For photo files, every press on **[ANGLE]** will turn the image clockwise by 90 degrees when an image is displayed.
- For a folder contains only photo files, file list or thumbnail list will be displayed, depending on the information from the home server.
- Video files with unsupported audio format will be skipped.
- The quality of the playback picture or audio differs depending on your network condition.

About DivX® and DivX® VOD

DivX

Useful tips for purchased or rented official DivX® Certified Videos

- When you purchase or rent a DivX® file through the official site of DivX® video which is called DivX® Video On-Demand (VOD) services, a registration code is required every time you get the new file from the DivX® VOD services. Refer to "DivX® VOD" in "LIST OF SETTINGS" on page 50.

Possible Errors

"This rental has 0 views left. Do you want to use one of your 0 views now?"

Some DivX® VOD files are restricted with limited playable times. You cannot play them back beyond the limit.

"This player is not authorized to play this video."

You cannot play back DivX® VOD files obtained with different registration codes on this unit.

"This rental is expired."

You cannot play back DivX® VOD files with an expired rental period.

"This player does not support this video format."

You cannot play back DivX® files whose resolution exceeds 1920 x 1080.

"This player does not support this audio format."

For DivX® files with audio format other than MPEG1 audio layer 3 (MP3), MPEG1 audio layer 2 and Dolby Digital, audio will not be output and only the video will be output.

Note

- A file with an extension of ".avi" and ".DivX" is called as a DivX® file. All files with the ".avi" extension are recognized as MPEG4.
- For CD-RW/-R, maximum of 255 group (folder) or 999 files may be recognized.
- For BD-RE/-R and DVD-RW/-R, maximum of 999 group (folder) or 9,999 files may be recognized.
- The 10th and deeper hierarchies cannot be displayed.
- Unrecognizable characters will be replaced with "□".
- When playing back files recorded in high bit rates, images can be interrupted in some occasions.
- Although DivX® logo has been obtained for this unit, it may not be able to play back some data, depending on the characteristics, bit rates, or audio format settings, etc.
- If a large-sized DivX® file is selected, it may take a while to start the playback (over 20 seconds sometimes).
- If DivX® files written on a CD-RW/-R cannot be played back, rewrite them on a BD-RE/-R or DVD-RW/-R, and try playing them back again.
- For more information about DivX®, please visit <http://www.divx.com>.

Playing Back DivX® with DivX® External Subtitle

DivX®

Subtitles created by the user can be displayed during DivX® playback.

1) Follow steps 1 to 3 in “Playing Back an Audio CD or a Disc with DivX® / MP3 / Windows Media™ Audio / JPEG Files” on pages 27-28.

2) Select a file you want to play back, then press [Green].

Subtitle list will appear.

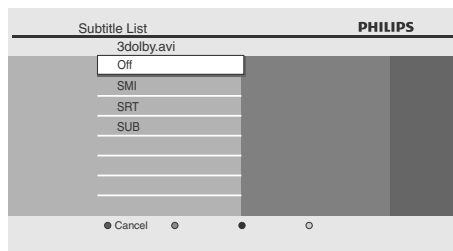

- “DivX Subtitle” appears next to “Green” icon only when DivX® subtitle is available for the selected file.
- If you press **[▶ (play)]** or **[OK]** instead of **[Green]**, playback without subtitle will start.

3) Select the desired subtitle file, then press [▶ (play)] or [OK].

Playback of the DivX® file with DivX® subtitle will start.

Note

- To utilize this function, the following conditions must be met:
 - Playback file and subtitle file must have the same name.
 - Playback file and subtitle file must be located in the same folder.
 - Only subtitle files with the following extensions are supported; .smi (.SMI), .srt (.SRT), .sub (.SUB), .ass (.ASS), .ssa (.SSA), .txt (.TXT). (.sub (.SUB) and .txt (.TXT) may not be recognized.)
 - Subtitles that exceeds the playback time of the DivX® file will not be displayed.
- If the DivX® subtitle file contains more than one subtitle language, you can toggle those by pressing **[SUBTITLE]** repeatedly.

Using the Title / Disc Menu



Some BD-video, DVD-video or AVCHD files may contain a title menu which describes the contents of the disc, or a disc menu which guides you through the available functions in the disc.

With such discs, a title menu or a disc menu may appear automatically when you insert the disc. Otherwise, press **[TOP MENU]** or **[DISC MENU / POP-UP MENU]** to call up the menu. Refer to the disc’s manual on how to navigate through the menu.

Note

- Menu vary among discs. Refer to the information accompanying the disc for details.
- **[TOP MENU]** or **[DISC MENU / POP-UP MENU]** may not work with some discs.
- Title menu is also available for SD card with AVCHD files.

SPECIAL PLAYBACK

Fast Forward / Fast Reverse



- 1) During playback, press [▶▶ (forward)] repeatedly for fast forward.
During playback, press [◀◀ (reverse)] repeatedly for fast reverse.
Every time you press [▶▶ (forward)] or [◀◀ (reverse)], the playback speed will change.
- 2) Press [▶ (play)] to return to the normal playback.

Note

- For BD, DVD and AVCHD, speed changes in 5 different levels.
- For audio CD, DivX®, MP3, Windows Media™ Audio, and video / audio files on DLNA home server, speed changes in 3 different levels.
- For some video / music files on DLNA home server or DivX® files, fast forward / fast reverse may not function.

Slow Forward Playback



- 1) During playback, press [|| (pause)]. Then press [▶▶ (forward)].
Every time you press [▶▶ (forward)], the playback speed changes in 3 different levels.
- 2) Press [▶ (play)] to return to the normal playback.

Note

- Only slow forward is available.
- For some video files on DLNA home server or DivX® files, slow forward may not function.

Step by Step Playback



- 1) In pause mode, press [|| (pause)] repeatedly.
Every time you press [|| (pause)], playback will advance one step at a time.
- 2) Press [▶ (play)] to return to the normal playback.

Note

- Only step by step forward is available.

Zoom



During playback, you can zoom up the picture.

- 1) During playback, press [ZOOM] repeatedly.
Every time you press [ZOOM], zoom factor will change.
e.g.) DVD-video

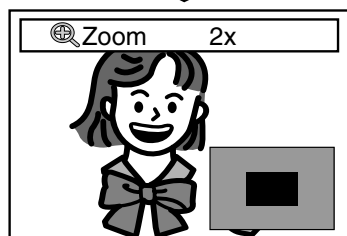
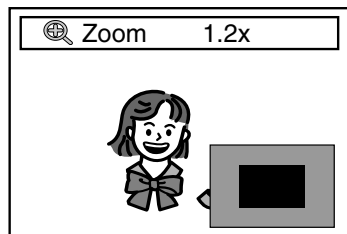

- 2) You can move over the zoomed picture using [▲ / ▼ / ◀ / ▶].
The gray box with an inner blue box displayed at the right bottom corner of the zoomed image is the position guide. The inner blue box indicates the zoomed area. (Not available for the JPEG and photo files on DLNA home server.)
- 3) Press [ZOOM] repeatedly to return to the normal playback.





























Note

- For JPEG files, slide show of the zoomed picture is not possible.
- For some DivX® files, zoom may not be available.
- For DivX® and JPEG files, 4x zoom is not available.
- For some DVDs, 4x zoom is not available.
- [ZOOM] does not work during the playback of the BD-video.
- [ZOOM] does not work while DVD menu is displayed.
- For JPEG files, when changing the zoom factor or moving the zoom position, the screen may become black for a moment. This is not a malfunction.

Repeat Playback

Available repeat function varies depending on the discs.

1) **During playback, press [REPEAT] repeatedly to select the desired repeat function.**

REPEAT MODE	AVAILABLE MEDIA
Chapter Repeat The current chapter will be played back repeatedly.	  
Title Repeat The current title will be played back repeatedly.	  
Track Repeat The current track or file will be played back repeatedly.	     
All Repeat All tracks in the media will be played back repeatedly.	
Group Repeat The current group (folder) will be played back repeatedly.	      
Random Repeat (Audio CD) Repeats the random playback.	
Random Repeat (DivX® / MP3 / Windows Media™ Audio / JPEG) Repeats the random playback in a folder.	      

Note

- The repeat setting will be cancelled when you stop playback.
- If you press [REPEAT A-B] when the repeat setting for BD, DVD, CD, AVCHD, DivX® file or video file on DLNA home server is set, the repeat setting will be cancelled.
- When the repeat setting is set for a MP3 or WMA folder (file), the repeat setting will be cancelled if you select other MP3 or WMA folder (file) to play back.
- For some video / music / photo files on DLNA home server or DivX® files, repeat playback may not function.

A-B Repeat



You can play back the specific part (between point A and point B) repeatedly.

- 1) **During playback, press [REPEAT A-B] once at the point where you want to set point A.**
- 2) **During playback, press [REPEAT A-B] again at the point where you want to set point B.**

As soon as you set point B, the part between point A and point B will start to play repeatedly.

To cancel A-B repeat:

Press [REPEAT A-B] repeatedly until "Off" appears.

Note

- Point B should be set within the same title, track or file as point A.
- If you press [REPEAT A-B] when the repeat setting for BD, DVD, CD, AVCHD, DivX® file or video file on DLNA home server is set, the repeat setting will be cancelled.
- For some video files on DLNA home server or DivX® files, A-B repeat playback may not function.
- To cancel the A point which was set, press [CLEAR].

Slide Show

JPEG

- 1) **Follow steps 1 to 3 in "Playing Back an Audio CD or a Disc with DivX® / MP3 / Windows Media™ Audio / JPEG Files" on pages 27-28.**
- 2) **Open the folder which contains the desired JPEG files.**
- 3) **Use [▲ / ▼ / ◀ / ▶] to select a desired file to be played back, then press ► (play) or [OK].**
 - An image will be played back from the selected file and go to the next one in turn every 10 seconds.
- 4) **Press [■ (stop)] to stop playback.**
 - To return to the first item:**
Press [TOP MENU].
 - To return to the file played last:**
Press [DISC MENU / POP-UP MENU].

Note

- Large-size JPEG files take a few moments to be displayed.

SPECIAL PLAYBACK

PiP (BONUSVIEW) Setting



Some BD-videos have the PiP function which enables you to display the secondary video in the primary video. You can call up the secondary video by pressing **[BONUSVIEW (PiP)]** whenever the scene contains the secondary video.

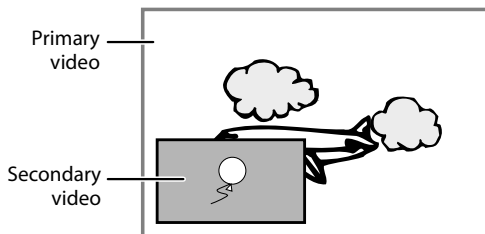

- 1) During playback, press [BONUSVIEW (PiP)].**
PiP information will appear.
- 2) Use [▲ / ▼] to select the secondary video you want to show.**
 - The secondary video will be displayed with the secondary audio.
 - Use [◀ / ▶] to switch between current setting and "Off".
- 3) Press [BACK ↵] to remove the PiP information.**
 - On how to output the secondary audio, refer to "Switching Audio Soundtrack" on page 38 and "Blu-ray Disc Audio" on page 47.

Enjoying BD-Live Discs with Internet



You can enjoy BD-Live which enables you to use interactive features when the unit is connected to the Internet.

Examples of BD-Live features:

- Online access to additional content such as movie trailers, subtitles, BD-Java applications, etc.
 - While downloading, special video data may be played back.
- **Service and functions differ depending on the disc. Follow the instructions given by the disc when using the BD-Live function.**
 - **You must insert an SD Memory Card when using the BD-Live function. (SD Memory Card of 1GB or more is recommended.)**
 - **Do not remove the SD Memory Card when using the BD-Live function.**

Note

- You must connect the unit to the Internet and set up necessary settings in order to use BD-Live.
- For the network connection, refer to "Connection to the Network" on page 20.
- For the network setup, refer to "Network Connection" on page 57.
- For certain discs, for "BD-Live Setting" may need to be changed.
- Depending on your connection environment, it may take time to connect to the Internet or the Internet may not be connected.
- When BD-Live functions are used and the unit is connected to the Internet, you may be charged for this communication.
- Some discs with BD-Live function require memory when playing back the content. If you cannot play back a disc with BD-Live function, insert an SD card(1GB or more) which is formatted on this unit.

Note for AACs Online

- The player or disc IDs may be sent to the content provider when playing back a disc with BD-Live function.
- If you save your viewing history on the server by using these IDs, you will be introduced to other similar movies.
- You can save game score histories.

Title / Chapter Search



Using [◀ (previous)] / [▶ (next)]

- 1) **During playback, press [▶ (next)] to skip the current title or chapter and move to the next.**
The title or chapter will move forward by one at a time.
 - If there is no chapter in one title, the current title may be skipped.
 To go back to the beginning of the current title or chapter, press [◀ (previous)].
Press [◀ (previous)] repeatedly to go to the previous title or chapter. The title or chapter may move backward one at a time.

Using [INFO ⓘ]

- 1) **During playback, press [INFO ⓘ].**
e.g.) DVD

Disc	
Title	001/012
Chapter	001/023
Playing Time	00:01:31
Audio	Dolby Digital

- 2) Use [▲ / ▼] to select "Title" or "Chapter".
- 3) Use [the Number buttons] or [◀ / ▶] to enter the title / chapter number.
- 4) Press [OK].
Playback will start from the beginning of the title / chapter.
- 5) Press [INFO ⓘ] to remove the information display.

Using [the Number buttons] (Direct Search)

Title Search

In stop mode, enter the title number you want to search using [the Number buttons].

Playback of the title will start in a few seconds.

Chapter Search

During playback of a title, enter the chapter number you want to search using [the Number buttons].

Playback of the chapter will start in a few seconds.

Note

- As for the BD-video, how it performs will be strongly determined by the disc, and may not perform as described.

Track Search



Using [◀ (previous)] / [▶ (next)]

- 1) **During playback, press [▶ (next)] to skip the current track or file and move to the next.**
The track / file will move forward one at a time. To go back to the beginning of the current track / file press [◀ (previous)].
Press it repeatedly to go to the previous track / file. The track / file will move backward one at a time.

Time Search



- 1) **During playback, press [INFO ⓘ].**
 - For DivX® files and video files on DLNA server, skip to step 3).

e.g.) DVD

Disc	
Title	001/012
Chapter	001/023
Playing Time	00:01:31
Audio	Dolby Digital

- 2) Use [▲ / ▼] to select "Playing Time".
- 3) Use [the Number buttons] to enter the time count you want to jump to.

e.g.)
Entering 1 hour 45 minutes and 15 seconds.

Press

- 4) Press [OK].
Playback will start from the desired time count.
- 5) Press [INFO ⓘ] to remove the information display.

Note

- For some video files on DLNA home server or DivX® files, time search may not function.

SPECIAL PLAYBACK

Switching Subtitles

Some video materials may have subtitles in one or more languages. For commercially available discs, the supported languages can be found on the disc case. Follow the steps below to switch the subtitle language during playback.



1) During playback, press [SUBTITLE] repeatedly to display "Primary", "Secondary" or "Subtitle Style".

- "Primary" : Sets the subtitle for the primary video.
"Secondary" : Sets the subtitle for the secondary video.
"Subtitle Style" : Sets style of the subtitle.

2) Use [▲ / ▼] to select your desired subtitle or style.

Primary 1 English

- Use [◀ / ▶] to switch between current subtitle setting and "Off".

3) Press [SUBTITLE] repeatedly to exit.



1) During playback, press [SUBTITLE].

2) Use [▲ / ▼] to select your desired subtitle.

Subtitle 1 English

- Use [◀ / ▶] to switch between current subtitle setting and "Off".

3) Press [SUBTITLE] to exit.

Note

- Some discs will only allow you to change the subtitles from the disc menu or pop-up menu. Press [TOP MENU] or [DISC MENU / POP-UP MENU] to display the disc menu or pop-up menu.
- If the disc has no subtitle language or subtitle style, "Not Available" will be displayed on the TV screen.
- During playback of the secondary video, the primary subtitle setting is not available except when there is no subtitle for the secondary video.
- For DivX® external subtitle, "Playing Back DivX® with DivX® External Subtitle" on page 33.

Switching Audio Soundtrack

When playing back video material recorded with two or more soundtracks (these are often in different audio languages or audio formats), you can switch them during playback. For BD, available audio varies depending on "Blu-ray Disc Audio" setting. Refer to page 47 for more information.



1) During playback, press [AUDIO] repeatedly to display "Primary" or "Secondary".

- "Primary" : Sets the audio for the primary video.
"Secondary" : Sets the audio for the secondary video.

2) Use [▲ / ▼] to select your desired audio stream channel.

Primary 2 English Dolby Digital Multi

- For "Secondary", use [◀ / ▶] to switch between current audio setting and "Off".

3) Press [AUDIO] repeatedly to exit.



1) During playback, press [AUDIO].

2) Use [▲ / ▼] to select your desired audio stream channel.

Audio 2 English Dolby Digital Multi

3) Press [AUDIO] to exit.

Note

- The secondary audio will not be output when the secondary video is not displayed or when "Blu-ray Disc Audio" is set to "Primary Audio Only". (For some BD, secondary audio will be output even when secondary video is off.)
- The sound mode cannot be changed during playback of discs not recorded in multiple audio.
- Some discs allow changing the audio language setting on the disc menu. (Operation varies depending on the discs. Refer to the manual accompanying the disc.)
- [AUDIO] may not work on some discs with multiple audio streams or channels (e.g. DVDs that allow changing audio setting on the disc menu).
- If the disc has no audio language, "Not Available" will be displayed on the TV screen.
- For DTS-CD (5.1 music disc), selecting audio streams or channels is not available.
- You can check the selected audio stream in the information display. To call up the information display, press [INFO ⓘ] during playback.

Switching Camera Angles



Some BD-video and DVD-video contain scenes which have been shot simultaneously from various angles. You can change the camera angle when  appears on the TV screen.

1) During playback, press [ANGLE].

- The selected angle will be displayed on the display bar at the top of the TV screen.

2) Use [▲ / ▼] to select your desired angle.



3) Press [ANGLE] to exit.

Note

- If "Angle Icon" setting is set to "Off",  will not appear on the TV screen. (Refer to page 50)

Philips Wireless MediaConnect

With this feature, you can enjoy your TV as a PC monitor wirelessly using your home network. Make sure you download the Philips Wireless MediaConnect software and install it on your PC before you perform the steps below.

Install Philips Wireless MediaConnect

- 1) Start your Internet browser on your PC and open the Philips Wireless MediaConnect download page at www.wifimediaconnect.philips.com. On the website, you can check the necessary PC system requirements.
- 2) Enter the 12 digit code printed on the bottom of your Blu-ray Disc Player.
- 3) Click the "Download now" button to download the free Philips Wireless MediaConnect software.
- 4) Once downloaded, start the file "Philips Wireless MediaConnect_setup.exe". Follow the instructions on the screen to complete software installation.

Using Philips Wireless MediaConnect

- 1) Launch Philips Wireless MediaConnect on your PC first.
- 2) Press [ (home)] on the Blu-ray Disc Player remote.
- 3) Use [▲ / ▼] to select "MediaConnect", then press [OK].
 - The startup screen for Philips Wireless MediaConnect will be displayed and the unit searches for an available PC that is running Philips Wireless MediaConnect software.

Once connected, the Philips Wireless MediaConnect software will encode and stream the screen of your PC as a video along with audio.

Depending on your computer and network configuration, there will be a delay between your PC screen and the TV but the audio-video will always be in sync.

Philips Wireless MediaConnect Help

To read the Philips Wireless MediaConnect Help, right click the program icon in the notification tray of the PC and select Help.

Specifics

You can project high definition (HD) or standard definition (SD) video, depending on the processing power of your PC. For smooth playback of HD video, please use a hardware accelerated video player on your computer. A hardware accelerated video player uses the graphics adapter of your PC to render HD video rather than the processor. This frees up the processor for Philips Wireless MediaConnect video encoding. The content protection on most DVD or Blu-ray Disc movies might restrict watching the movie on TV when the disc is playing on a PC. The TV shows PC media files with a small delay. Philips Wireless MediaConnect is only available for PC.

PC and network requirements

Supported OS

Windows XP, Windows Vista, Windows 7 (PC only)

Minimum requirements

- Intel Core 2 Duo 1.8GHz
- 512MB RAM
- IEEE 802.11n

Recommended requirements

- Intel Core 2 Duo 2.1GHz
- 1GB RAM

NETFLIX OPERATIONS

With this unit, you can watch movies and TV episodes streamed instantly from Netflix via the Internet. In order to use this feature, you must visit the following website on your PC and become a Netflix member.

netflix.com/Philips

Before Activating the Connection to Netflix

After creating a Netflix account at netflix.com/Philips, follow the following procedure before activating the connection to Netflix.

- 1) **Connect this unit to the Internet.**
 - Refer to "Connection to the Network" on page 20.
- 2) **Set up the necessary network connection settings.**
 - Refer to "Network Connection" on page 57.

Activating the Connection to Netflix

In order to watch movies and TV episodes streamed instantly from Netflix via the Internet, you must activate the connection between this unit and your Netflix account.

- 1) Press [**▲** (home)] to access the home menu.
- 2) Use [**▲** / **▼**] to select "NETFLIX", then press [**OK**].
 - Netflix welcome screen will appear.
 - For the first time only, "Network Service Disclaimer" screen will appear. After confirming the content, use [**◀** / **▶**] to select "Agree", then press [**OK**].
- 3) Use [**▲** / **▼**] to select "yes - activate instant streaming from Netflix", then press [**OK**].
 - Activation screen with the activation code will appear.



- 4) **On your PC, visit netflix.com/activate and log into your account.**
 - The entry screen of activation code will appear on your PC screen.
- 5) **Enter the activation code which is displayed on the TV screen.**
 - The instant Queue will appear.
 - The connection to Netflix is successfully made.
 - To browse the instant Queue and watch movies, skip to step 3) in "Watching Streaming Movies" on page 40.

Note

- Netflix is available only in the United States.
- You cannot create a Netflix account on this unit.
- If newer version of software is required, software upgrade screen may appear after selecting "NETFLIX" in step 2). (For software upgrade, refer to "Software Upgrade" on page 62.)
- You can deactivate the connection to Netflix by setting the "Netflix Deactivate" to "Yes". (Refer to page 51.)
- The screen image of Netflix may change after upgrading the software.
- For questions regarding the Netflix service, visit netflix.com/Help.
- When you contact the Netflix customer service, you may be asked for the ESN number, which is a serial number to identify this unit by Netflix. You can check the ESN number on the bottom of the "Netflix Deactivate" screen. (Refer to page 51.)

Watching Streaming Movies

After you set up the connection to Netflix, you can browse the instant Queue and watch movies on your TV.

- 1) Press [**▲** (home)] to access the home menu.
- 2) Use [**▲** / **▼**] to select "NETFLIX", then press [**OK**].
 - The instant Queue will appear.
- 3) Use [**◀** / **▶**] to select the desired movie or TV episode, then press [**▶** (play)] to start playback.



- After loading, playback of the selected movie or TV episode will start.
- To stop the playback, press [**■** (stop)].
- To go back to the instant Queue, press [**Red**].
- To go back to the home menu, press [**▲** (home)].

About the Instant Queue

- Instant Queue is the list of movies and TV episodes you add on the Netflix website. (netflix.com) You can manage the movies and TV episodes in your instant Queue from the Netflix website on your PC.
- You cannot add movies or TV episodes to your instant Queue on this unit.
- You can remove movies or TV episodes from the instant Queue on this unit.

Note

- The picture quality differs depending on the speed of your Internet connection at the time of loading.

CINEMANOW / BLOCKBUSTER OPERATIONS

With this unit, you can watch movies and TV episodes streamed instantly from CinemaNow / Blockbuster via the Internet. In order to use this feature, you must visit the following website and create a CinemaNow / Blockbuster account.

- For CinemaNow, visit www.cinemanow.com/Login
- For Blockbuster, visit www.blockbuster.com/auth/login

Before Activating the Connection to CinemaNow / Blockbuster

After creating a CinemaNow / Blockbuster account, follow the following procedure before activating the connection to CinemaNow / Blockbuster.

- 1) Connect this unit to the Internet.**
 - Refer to "Connection to the Network" on page 20.
- 2) Set up the necessary network connection settings.**
 - Refer to "Network Connection" on page 57.

Activating the Connection to CinemaNow / Blockbuster

In order to watch movies and TV episodes streamed instantly from CinemaNow / Blockbuster via the Internet, you must activate the connection between this unit and your CinemaNow / Blockbuster account.

- 1) On your PC, visit following website and log into your account to get the activation code.**
 - Follow the instruction given by the website.
 - Take a note of the activation code which appears on the PC.
- For CinemaNow, visit www.cinemanow.com/activate.
- For Blockbuster, visit www.blockbuster.com/activate/philipsbd.
- 2) On this unit, press [↑ (home)] to access the home menu.**
- 3) Use [▲ / ▼] to select "CinemaNow" or "BLOCKBUSTER", then press [OK].**
 - Menu screen of CinemaNow or Blockbuster will appear.
 - For the first time only, "Network Service Disclaimer" screen will appear. After confirming the content, use [◀ / ▶] to select "Agree", then press [OK].
- 4) Use [▲ / ▼ / ◀ / ▶] to select "Settings" (CinemaNow) or "Configure" (Blockbuster), then press [OK].**
 - For CinemaNow, select "Activate" and press [OK] again in the next screen.
 - Activation code input screen will appear.

e.g.) CinemaNow



- 5) Enter the activation code displayed on your PC using [◀ / ▶] and [the Number buttons], then select "Activate" and press [OK].**
 - For CinemaNow, confirmation message will appear. Press [OK] to complete the setting.

Note

- The image of menu screen may change without notice after upgrading the software or the information on CinemaNow / Blockbuster server is changed.
- You cannot create CinemaNow / Blockbuster account on this unit.
- To deactivate the connection to CinemaNow or Blockbuster, select "Deactivate" in "Settings" (CinemaNow) or "Configure" (Blockbuster).
- For questions regarding CinemaNow service, visit www.cinemanow.com/support.
- For questions regarding Blockbuster service, visit www.blockbuster.com/help.

Guide to CinemaNow / Blockbuster Menu Screen

CinemaNow

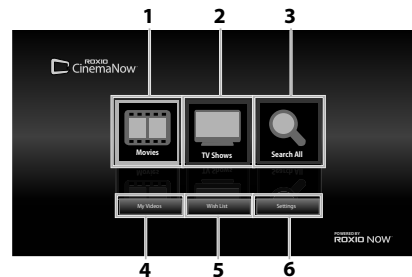

Blockbuster

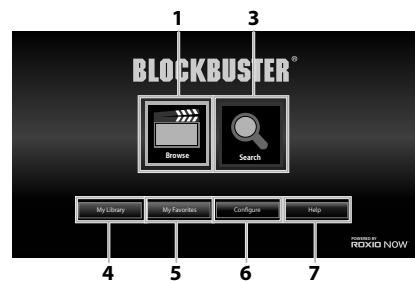

- | | |
|------------------------------------|--|
| 1) Movies / Browse | : To access the movie list |
| 2) TV Shows | : To access the TV show list |
| 3) Search All / Search | : To access search screen |
| 4) My Videos / My Library | : To access the list of rented or purchased movies / TV episodes |
| 5) Wish List / My Favorites | : To access your wish list / favorite list |
| 6) Settings / Configure | : To access setting / configure menu |
| 7) Help | : To access the help page |

Renting or Purchasing Movies / TV episodes

After you set up the connection to CinemaNow / Blockbuster, you can rent or purchase movies / TV episodes and watch directly on your TV.

- 1) Press [**▲** (home)] to access the home menu.
- 2) Use [**▲** / **▼**] to select "CinemaNow" or "BLOCKBUSTER", then press [OK].
- 3) Use [**▲** / **▼** / **◀** / **▶**] to select "Movies", "Browse" or "TV Shows", then press [OK].
 - List of movies / TV episodes will appear.
- 4) Use [**▲** / **▼** / **◀** / **▶**] to select the desired title, then press [OK].
 - Title details screen of the selected title will appear.
- 5) Use [**◀** / **▶**] to select "Rent" or "Buy", then press [OK].
 - Checkout screen will appear.
- 6) Use [**◀** / **▶**] to select "Submit Order", then press [OK].
- 7) Use [**◀** / **▶**] to select "Watch Now", then press [OK].
 - If you want to continue browsing, select "Continue Browsing" and press [OK] to go back to "Movies" or "Browse".

Note

- If you select "Add to Wish List" (CinemaNow) or "Add to My Favorites" (Blockbuster) in title details screen, the title will be added to your "Wish List" or "My Favorites".
- For CinemaNow, if you want to redeem a gift code, select "Redeem Gift Code" in the checkout screen, then press [OK] and enter the gift code.
- In most cases, rented movies or TV episodes are available for 24 hours from the playback starting time.

Searching Movies / TV episodes

From the search screen, you can search for movies / TV episodes by entering search words.

- 1) Follow steps 1) to 2) in "Renting or Purchasing Movies / TV episodes" on page 42.
- 2) Use [**▲** / **▼**] to select "Search All" (CinemaNow) or "Find" (Blockbuster), then press [OK].
 - Keypad screen will appear.
- 3) Use [**▲** / **▼** / **◀** / **▶**] to select characters, then press [OK].
 - When you enter a letter, titles that start with the letter will be displayed on the right side of the screen.
- 4) Use [**▲** / **▼** / **◀** / **▶**] to select a desired title from the search result on the right side of the screen, then press [OK].
 - Title details screen of the selected title will appear.

Watching Rented or Purchased Movies / TV episodes

- 1) Follow steps 1) to 2) in "Renting or Purchasing Movies / TV episodes" on page 42.
- 2) Use [**▲** / **▼** / **◀** / **▶**] to select "My Videos" (CinemaNow) or "My Library" (Blockbuster), then press [OK].
 - List of rented or purchased movies / TV episodes will appear.
- 3) Use [**▲** / **▼** / **◀** / **▶**] to select a desired title, then press [OK].
- 4) Use [**◀** / **▶**] to select "Watch from Start" (CinemaNow) or "Play Now" (Blockbuster), then press [OK].
 - If you want to resume playback, select "Resume Play" and press [OK].
 - To stop the playback, press [**■** (stop)].
 - To pause the playback, press [**⏸** (pause)].
 - To go back to the home menu, press [**▲** (home)].

Note

- Depending on your network environment and speed, the playback may be paused or stopped. To improve playback condition, use high speed broadband Internet connection (For details, contact your Internet service provider.)

VUDU OPERATIONS

With this unit, you can enjoy VUDU HD on-demand movies / TV episodes and Internet applications. In order to use this feature, you must connect this unit to the Internet. (Broadband Internet connection of 8 Mbps or faster is recommended.)

- For network connection, refer to "Connection to the Network" on page 20.
- For network setup, refer to "Network Connection" on page 57.

For complete instructions on using VUDU service, please visit www.vudu.com/docs to view an updated in-depth online manual.

Activating VUDU

After you set up the network connection, you must set up a VUDU account and activate this unit before watching VUDU movies.

- 1) Press [**Home**] to access the home menu.
- 2) Use [**Up** / **Down**] to select "vudu", then press [**OK**].
 - VUDU App Home screen will appear.
 - For the first time only, "Network Service Disclaimer" screen will appear. After confirming the content, use [**Left** / **Right**] to select "Agree", then press [**OK**].
- 3) Use [**Up** / **Down** / **Left** / **Right**] to select "VUDU movies", then press [**OK**].
 - VUDU welcome screen will appear.
- 4) Select "SIGN Up Now", then press [**OK**].
- 5) Enter the e-mail address you would like associated with your VUDU account. After you enter your e-mail address correctly, select "Done" and press [**OK**].
 - Activation e-mail will be sent to the e-mail address. (You must have access to the e-mail address to activate VUDU.)
- 6) Follow directions in the activation e-mail to complete your account activation.

Note

- You can deactivate the connection to VUDU by setting "Vudu Deactivate" to "Yes". (Refer to page 51.)
- For questions regarding VUDU service, please contact VUDU Customer Care at 1-888-554-VUDU (8838) or visit www.vudu.com/support.

Guide to VUDU Menu Screen

App Home Screen

App Home screen is the entry point to VUDU applications including VUDU movies.

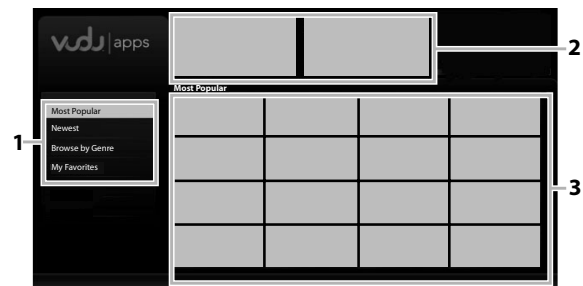

- 1) **Viewing mode** : List of different viewing modes for App Home applications
- 2) **Promotional graphics** : Placeholder where promotional graphics are displayed
- 3) **Application list** : Grid of applications in the selected viewing mode

VUDU Movies Home Screen

When you select "VUDU movies" in App Home screen, VUDU movies home screen will appear.

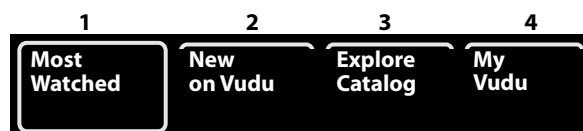

- 1) **Most Watched** : To access the list of popular movies / TV episodes on VUDU
- 2) **New on Vudu** : To access the list of newly available movies / TV episodes
- 3) **Explore Catalog** : To access the list of options to search movies / TV episodes
- 4) **My Vudu** : To access the list of rented or purchased contents

Note

- You can go back to VUDU movies home screen by pressing [**Blue**] while you are using VUDU movies features.

VUDU OPERATIONS

Renting or Purchasing VUDU Movies

After activating this unit, you are ready to purchase or rent movies / TV episodes and watch directly on your TV.

- 1) Select a desired movie or TV episode by navigating VUDU movies menus. Press [OK] to display the "MOVIE DETAILS" screen.
- 2) Use [▲ / ▼] to select "Rent / Own", then press [OK].
- 3) Use [▲ / ▼] to select a desired quality option, then press [OK].
 - Select the quality option that best suits your network environment.

	Video Resolution	Minimum Bit Rate
SD	480p	1 Mbps
HD	720p	2.25 Mbps
HDX	1080p	4.5 Mbps

- 4) Use [▲ / ▼] to select "Rent for \$*.***" or "Buy for \$*.***", then press [OK] to confirm your rental or purchase.
- 5) Select "Watch Now" to start playing the movie / TV episode.
 - If you want to return to the "MOVIE DETAILS", select "Watch Later".

Note

- Available quality options differ depending on the content.

Watching Rented or Purchased VUDU movies

- 1) In VUDU movies home screen, select "My Vudu" and press [OK].
- 2) Use [◀ / ▶] to select "My Rentals", "My Movies" or "My TV Shows", then press [OK].
- 3) Use [▲ / ▼] to select a desired movie / TV episode, then press [OK].
- 4) Select "Watch" or "Watch ****" to start watching the movie / TV episode.
 - During playback, use following buttons to control the playback.

Button	Action
[(pause)]	Pause the playback.
[■ (stop)]	Stop the playback.
[◀◀ (reverse)] / [▶▶ (forward)]	Fast reverse or forward the playback.
[▶ (play)]	Resume the playback.
[Yellow]	Display the info banner which shows the playback information.
[⬆ (home)]	Go back to the home menu.

Note

- Available buttons and actions may subject to change without notice.

Using Internet Applications

In addition to VUDU movies, you can use various kinds of Internet applications.

- 1) In App Home screen, use [▲ / ▼ / ▶ / ◀] to select a desired application and press [OK].
- 2) Follow the instructions on screen of the selected application.

Note







- Available applications may change without notice.

LIST OF SETTINGS

In the settings menu, you can customize the various kinds of settings as you prefer. Refer to the following instruction to navigate through the settings menus.

- 1) Press [**⬆** (home)] to access the home menu.
- 2) Use [**▲** / **▼**] to select "Settings", then press [OK].
- 3) Use [**▲** / **▼**] to select the desired setting, then press [OK].
- 4) Use [**▲** / **▼**] to move the highlight up and down in the list.
 - Options of the highlighted item will be displayed in the list on the right whenever available.
- 5) To make a selection or to access options of an item, select the desired item, then press [OK].
 - To go back to the previous screen, press [BACK **⬅**].
- 6) Press [**⬆** (home)] to exit.

Refer to the following table for the types of settings you can customize. The item highlighted in gray is the default setting.

Category	Menus / Options		Description
3D Output  This feature is available only when the display device is connected by an HDMI cable.	Auto (XX) 3D 2D		Sets the 3D output mode for playback of Blu-ray 3D Discs. "Auto (XX)" : Playback picture will be output in 3D or 2D mode, depending on a disc or the connected TV. (Inside the parenthesis next to "Auto" will be the current output mode.) "3D" : Outputs the picture in 3D mode. "2D" : Outputs the picture in 2D mode.
Language	Audio   AVCHD	Default Čeština Dansk Deutsch English Español Ελληνικά Français Italiano Magyar Nederlands Norsk Polski Português Русский suomi Svenska Türkçe	Sets the audio language for BD-video, DVD-video or AVCHD playback. • If you select "Default", the disc's original language will be in effect.
	Subtitle   AVCHD	Off Čeština Dansk Deutsch English Español Ελληνικά Français Italiano Magyar Nederlands Norsk Polski Português Русский suomi Svenska Türkçe	Sets the subtitle language for BD-video, DVD-video or AVCHD playback.
	Disc Menu   AVCHD	Čeština Dansk Deutsch English Español Ελληνικά Français Italiano Magyar Nederlands Norsk Polski Português Русский suomi Svenska Türkçe	Sets the language for disc menu.
	Player Menu	Auto (XXXX) English Español Français	Sets the language for player menu (OSD menu) "Auto" : Activates the Get & Set Menu Language function. Refer to page 62. • "Auto" is available only when "EasyLink (HDMI CEC)" is set to "On". • Inside the parenthesis next to "Auto" will be the current selected language.

LIST OF SETTINGS

Category	Menus / Options		Description	
Video Output	TV Shape	4:3 Normal 4:3 Crop 16:9 Widescreen 16:9 Squeeze	Sets the aspect ratio of the playback image to fit your TV.	
	HDMI Video	HDMI 1080p/24 	Auto Off	<p>"Auto": Outputs the picture in 1080p/24 (1080 progressive with 24 frames per second) when it meets all the conditions listed below:</p> <ul style="list-style-type: none"> The video resolution and the frame rate of the material is 1080p/24 . "HDMI Video Resolution" setting is set to "1080p". The display device supports the 1080p/24 output. <p>"Off": • Outputs the picture in 1080p/60. (60 frames per second, progressive)</p>
		HDMI Video Resolution	Auto 480p 720p 1080i 1080p	Sets the resolution of the video signal being output from the HDMI OUT jack. • The selected resolution must also be supported by your TV monitor.
		HDMI Deep Color	Auto Off	Reduces the posterization effect of the playback picture. "Auto": Reduces the posterization effect by automatically outputting up to 36 bit color whenever the unit recognizes the connected display device supports Deep Color feature. "Off": Outputs the standard 24 bit color.
	Component Output	480i 480p		Sets resolution for component output picture.
		720p 1080i	With regard to DVD-video with copy protection, the resolution will be set to 480p regardless of the setting here. If 480p output is not available, 480i will be output.	<ul style="list-style-type: none"> The selected resolution must also be supported by your TV monitor. Refer also to your TV's manual. If you have selected the resolution not supported by your TV by mistake and the picture gets disturbed, press and hold [▶ (play)] on the front panel for 5 seconds to change the setting back to its default. When HDMI cable is connected, only "480i" and the resolution selected in the "HDMI Video Resolution" will be available.

LIST OF SETTINGS

Category	Menus / Options		Description
Video Output	De-interlacing Mode	Auto Video	<p>"Auto": Automatically detects film or video content, and appropriately converts it.</p> <p>"Video": Select this option when the picture is distorted when using "Auto".</p>
	Black Level	On Off	Adjusts brightness to compensate for ambient room light.
	HD Noise Reduction	On Off	<p>Reduces noise of the playback picture.</p> <p>"On": Activates Noise Reduction.</p> <p>"Off": Deactivates Noise Reduction.</p>
Audio	Night Mode	Auto On Off	<p>Compresses range between soft and loud sounds.</p> <p>"Auto": Night Mode will be activated automatically when Dolby TrueHD audio is played back.</p> <p>"On": Activates the Night Mode.</p> <p>"Off": Deactivates the Night Mode.</p>
	Down Sampling	On Off	<p>Sets the sampling rate for outputting PCM audio from the digital output (coaxial).</p> <p>"On": Over 96 kHz PCM audio will be down sampled at 48 kHz.</p> <p>"Off": For BD or DVD recorded in LPCM without copyright protection, 2-channel audio signals up to 96 kHz are output as LPCM signals.</p>
	Virtual Surround	On Off	Select "On" to enjoy stereophonic virtual space through your existing 2 channel stereo system during playback of BD-video or DVD-video.
	Blu-ray Disc Audio	Mix Audio Output Primary Audio Only	<p>"Mix Audio Output": The audio for the secondary video and the interactive application will be output together with the audio for the primary video.</p> <p>"Primary Audio Only": Only audio for the primary video will be output.</p> <p>When playing back a BD-video which only contains primary audio, the audio output will be the same case as "Primary Audio Only" even if the "Blu-ray Disc Audio" is set to "Mix Audio Output".</p>

EN

Introduction

Connections

Basic Setup

Playback

Function Setup

Others

LIST OF SETTINGS

Category	Menus/Options		Description
Audio	HDMI Audio <ul style="list-style-type: none"> This feature is available only when the display device is connected by an HDMI cable. Refer to page 53 for more information. 	HDMI Normal PCM Off	Sets the audio format for sound output from the HDMI OUT jack.
	Digital Out <ul style="list-style-type: none"> When HDMI cable is connected, make sure "HDMI Audio" setting is set to "Off" to change the "Digital Out" setting. Refer to page 55 for more information. 	Bitstream PCM	Sets the audio format for the sound output from the DIGITAL OUT (COAXIAL) jack.
Ratings Lock • Refer to page 56 for more information.	Rating Level	All 8 [Adult] to 1 [Kid Safe]	Sets the rating level for the disc playback.
	New PIN		Sets the new password for the "Ratings Lock" setting.

LIST OF SETTINGS

Category	Menus / Options		Description			
Network Connection • Refer to pages 57-61 for more information.	Connection Test		Perform a network connection test. After you change IP address or DNS setting, always perform this test.			
	Network Selection	Wired Connection	Standard	If you select "Standard", connection test will automatically start.		
			Manual	IP Address Setting	Auto(DHCP)	Set the IP address. In most cases, you can connect to the Internet without making any changes to the default setting.
					Manual	
			Subnet Mask			
			Default Gateway			
			DNS Setting	Auto(DHCP)	Set the DNS setting. In most cases, you can connect to the Internet without making any changes to the default setting.	
				Manual		Primary DNS
					Secondary DNS	
			Proxy Setting	Do Not Use	Set the proxy server. In most cases, you can connect to the Internet without using proxy server.	
				Use		Proxy Address
			Proxy Port			
		Connection Speed	Auto	Set the connection speed. In most cases, you can connect to the Internet without making any changes to the default setting.		
			10BASE Half			
			10BASE Full			
			100BASE Half 100BASE Full			
		BD-Live Setting	Allow	You can restrict Internet access when BD-Live functions are used.		
			Limited Allow Prohibit			
		Network Status		You can check the current status of the network setting.		
	Wireless Connection	Wireless Router	Find wireless network	WEP/WPA Authentication		
Manually enter your SSID						
Wireless Router Status			You can check the current status of the wireless router setting.			
Advanced Settings		Standard	If you select "Standard", connection test will automatically start.			
		Manual	IP Address Setting	Set the IP address. In most cases, you can connect to the Internet without making any changes to the default setting.		
					DNS Setting	
			Proxy Setting			
			BD-Live Setting			
			Network Status			
Disable		Yes	Deactivates the network connection.			
		No				
Disclaimer			Displays the network service disclaimer.			

EN

Introduction

Connections

Basic Setup

Playback

Function Setup

Others

LIST OF SETTINGS

Category	Menus / Options		Description	
Others	Angle Icon	On <input type="checkbox"/> Off <input type="checkbox"/>	<p>"On": The angle icon automatically appears on the TV screen when playing back content with various camera angles available.</p> <p>"Off": The angle icon does not automatically appear on the TV screen when playing back content with various camera angles available.</p>	
	Front Panel Brightness	Bright <input type="checkbox"/> Dim <input type="checkbox"/> Auto <input checked="" type="checkbox"/>	Sets the brightness of the front panel display. When "Auto" is selected, the front panel display automatically goes dim during playback.	
	Screen Saver	On <input type="checkbox"/> Off <input type="checkbox"/>	Sets whether to activate the screen saver after 5 minutes of no action on the unit.	
	Slide Show Transition JPEG <input type="checkbox"/>	Cut In/Out <input type="checkbox"/> Fade In/Out <input type="checkbox"/>	Sets the visual effect for the slide show transition mode. "Cut In/Out": The pictures will cut in and out sharply as playback progresses. "Fade In/Out": The pictures will fade in and out as playback progresses.	
	DivX® VOD DivX <input type="checkbox"/>	Registration Code	Your registration code is : ○○○○○○○○○○○○ To learn more visit www.divx.com/vod	This menu item provides you with the DivX® VOD registration code. The DivX® registration code is required when downloading DivX® VOD files from the Internet. To learn more about DivX® VOD, visit www.divx.com/vod .
		Deactivation Code	Your deactivation code is : ○○○○○○○○○○ To learn more visit www.divx.com/vod	This menu item provides you with the DivX® VOD deactivation code. The DivX® deactivation code is required when re-downloading DivX® VOD files from the Internet after deactivating. To learn more about DivX® VOD, visit www.divx.com/vod .
		Deactivation	Yes <input type="checkbox"/> No <input checked="" type="checkbox"/>	This menu deactivates this unit and provides you with new registration code and deactivation code in order to download DivX® VOD files from the Internet.
EasyLink (HDMI CEC) • This feature is available only when the display device is connected with an HDMI cable, and when it supports EasyLink (HDMI CEC) feature. • Refer to page 62 for more information.	On <input type="checkbox"/> Off <input type="checkbox"/>	Sets whether to utilize the EasyLink (HDMI CEC) function. EasyLink (HDMI CEC) function allows your PHILIPS brand EasyLink TV to act in conjunction with this unit or vice versa.		

LIST OF SETTINGS

Category	Menus / Options		Description	
Others	Software Upgrade • Refer to page 62 for more information.	Disc Upgrade	Yes No	Set the disc upgrade. You can upgrade the software version by using a disc. To download the latest software version, please visit www.philips.com/support .
		Network Upgrade	Yes No	Set the network upgrade. You can upgrade the software version by connecting this unit to the Internet.
	Product Info		Displays the product info screen.	
Factory Default	Settings	Yes No	<p>"Yes": Resets all the settings, except for "Ratings Lock" and "Network Connection", in "Settings" to the factory default.</p> <p>"No": Does not perform the initialization.</p>	
	Format SD Card	Yes No	<p>"Yes": Re-format SD card.</p> <p>"No": Does not format the SD card.</p>	
	Local Storage	Player	Yes No	<p>"Yes": Re-format local storage (Player) used for BD-Java.</p> <p>"No": Does not perform the initialization.</p>
		SD Card	Yes No	<p>"Yes": Re-format local storage (SD card) used for BD-Java.</p> <p>"No": Does not format the SD card.</p>
	Network Settings	Yes No	<p>"Yes": Initializes manually entered or automatic (default) network settings.</p> <p>"No": Does not perform the initialization.</p>	
	Netflix Deactivate	Yes No	<p>"Yes": Deactivates the connection to Netflix.</p> <p>"No": Does not perform the deactivation.</p>	
	Vudu Deactivate	Yes No	<p>"Yes": Deactivates the connection to VUDU.</p> <p>"No": Does not perform the deactivation.</p>	

EN

Introduction

Connections

Basic Setup

Playback

Function Setup

Others

SETUPS

TV Shape

home → "Settings" → "Video Output" → "TV Shape"

Use this feature to adjust the aspect ratio of the video source which is different from your TV's ratio to fit your TV monitor without distorting the picture. Descriptions of each setting are as follows:

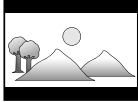
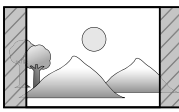
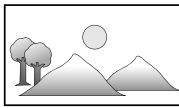
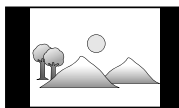
Video source	Your TV	Option	Description
16:9	4:3	4:3 Normal 	To enjoy 16:9 picture on 4:3 monitor: 16:9 picture is scaled down until both sides of the picture fits the 4:3 TV.
		4:3 Crop 	To enjoy 16:9 picture on 4:3 monitor: Both sides of the picture are trimmed to fit the 4:3 TV without distorting the aspect ratio of the picture.
	16:9 Widescreen 	To enjoy 16:9 picture on 16:9 monitor: Select this setting when you want to enjoy 16:9 picture on the 16:9 TV.	
4:3	16:9	16:9 Squeeze 	To enjoy 4:3 picture on 16:9 monitor: Use this setting to display 4:3 picture on the 16:9 TV without distorting the aspect ratio of the picture.

HDMI Video Resolution

home → "Settings" → "Video Output" → "HDMI Video" → "HDMI Video Resolution"

Set the resolution of the video signal being output from the HDMI OUT jack.

You can select the desired "HDMI Video Resolution" among the settings listed below:

"Auto", "480p", "720p", "1080i", "1080p"

- When you make a selection, the TV monitor temporarily goes blank and then comes back again. If it does not, press [HDMI] to change the resolution or press and hold ► (play) on the front panel for 5 seconds to change the setting back to its default.

Actual Output Resolution by Media:

Media	BD				
	Source				
Setting in the "HDMI Video Resolution"	480i/60	720p/60	1080i/60	720p/24	1080p/24
480p	480p/60	480p/60	480p/60	480p/60	480p/60
720p	720p/60	720p/60	720p/60	720p/60	720p/60
1080i	1080i/60	1080i/60	1080i/60	1080i/60	1080i/60
1080p	1080p/60	1080p/60	1080p/60	1080p/60	1080p/24 or 60 ^(*)
Auto	The highest resolution supported by your display device will be in effect automatically.				

(*) To output the video in 24 Hz, the connected display device must support 24 Hz output, and "HDMI 1080p/24" should be set to "Auto". Otherwise, the image will be output in 60 Hz.

Media	DVD	AVCHD	DivX®	Photo viewing	OSD-only viewing
	Setting in the "HDMI Video Resolution"	Source			
	480i/60	1080p/24	60, 30, other		
480p	480p/60	480p/60	480p/60	480p/60	480p/60
720p	720p/60	720p/60	720p/60	720p/60	720p/60
1080i	1080i/60	1080i/60	1080i/60	1080i/60	1080i/60
1080p	1080p/60	1080p/60	1080p/60	1080p/60	1080p/60
Auto	The highest resolution supported by your display device will be in effect automatically.				

- When HDMI cable is connected, only "480i" and the resolution selected in the "HDMI Video Resolution" will be available for the "Component Output".
- Composite video out (VIDEO OUT) can only output 480i/60.
- For AVCHD and DivX®, outputting the video in 24 Hz (1080p/24) is not available.

Note

- The selected resolution must also be supported by your display device.
- If your TV and the unit is connected by a DVI cable and if you select "Auto", "480p" will be in effect automatically.
- Pressing ► (play) on the front panel for 5 seconds changes the setting back to its default. ("Component Output" setting will also be reset to default (480i).)
- Refer also to your TV's manual.
- When the HDMI OUT jack is outputting the video in 1080p/24, picture will not be output from the VIDEO OUT jack and COMPONENT VIDEO OUT jacks.
- When playing back a Frame Sequential 3D Disc, video resolution of output picture will depend on contents on the disc. ("HDMI Video Resolution" setting is not effective for Frame Sequential 3D Discs.)

SETUPS

HDMI Audio

home → "Settings" → "Audio" → "HDMI Audio"

Refer to the table below to see which setting you should choose.

	"HDMI Audio" setting →	"HDMI Normal"		"PCM"		"Off"
	"Blu-ray Disc Audio" setting →	"Primary Audio Only"	"Mix Audio Output"	"Primary Audio Only"	"Mix Audio Output"	Regardless
Media ↓	Audio Source ↓	Which audio format can be output depends on the compatibility of the connected device.				
BD-video	Dolby Digital	Dolby Digital or Multi PCM or Mute	Dolby Digital or Multi PCM or Mute	Multi PCM or Mute	Multi PCM or Mute	Mute
	Dolby Digital Plus	Dolby Digital Plus or Dolby Digital or Multi PCM*1 or Mute	Dolby Digital or Multi PCM*2 or Mute	Multi PCM*1 or Mute	Multi PCM*2 or Mute	Mute
	Dolby TrueHD	Dolby TrueHD or Dolby Digital or Multi PCM*3 or Mute	Dolby Digital or Multi PCM*4 or Mute	Multi PCM*3 or Mute	Multi PCM*4 or Mute	Mute
	DTS®	DTS® or Multi PCM or Mute	DTS® or Multi PCM or Mute	Multi PCM or Mute	Multi PCM or Mute	Mute
	DTS-HD®	DTS-HD® or DTS® or Multi PCM*1 or Mute	DTS® or Multi PCM*5 or Mute	Multi PCM*1 or Mute	Multi PCM*5 or Mute	Mute
	LPCM	Multi PCM or Mute	Multi PCM or Mute	Multi PCM or Mute	Multi PCM or Mute	Mute
DVD-video	Dolby Digital	Dolby Digital, Multi PCM or Mute		Multi PCM or Mute		Mute
	DTS®	DTS®, Multi PCM or Mute		Multi PCM or Mute		Mute
	LPCM	2ch PCM or Mute		2ch PCM or Mute		Mute
DTS-CD	DTS®	DTS®, Multi PCM or Mute		Multi PCM or Mute		Mute
AVCHD	Dolby Digital	Dolby Digital or Multi PCM or Mute		Multi PCM or Mute		Mute
	LPCM	Multi PCM or Mute		Multi PCM or Mute		Mute

SETUPS

	"HDMI Audio" setting →	"HDMI Normal"		"PCM"		"Off"
	"Blu-ray Disc Audio" setting →	"Primary Audio Only"	"Mix Audio Output"	"Primary Audio Only"	"Mix Audio Output"	Regardless
Media ↓	Audio Source ↓	Which audio format can be output depends on the compatibility of the connected device.				
DivX®	Dolby Digital	Dolby Digital or Multi PCM or Mute		Multi PCM or Mute		Mute
	MP3 / MP2	2ch PCM or Mute		2ch PCM or Mute		Mute
Audio CD	PCM	2ch PCM or Mute		2ch PCM or Mute		Mute
MP3	MP3	2ch PCM or Mute		2ch PCM or Mute		Mute
Windows Media™ Audio	WMA	2ch PCM or Mute		2ch PCM or Mute		Mute
DLNA Video	Dolby Digital	Dolby Digital or Multi PCM or Mute		Multi PCM or Mute		Mute
	MP2	2ch PCM or Mute		2ch PCM or Mute		Mute
	LPCM	Multi PCM or Mute		Multi PCM or Mute		Mute
DLNA Music	MP3 / WMA / LPCM	2ch PCM or Mute		2ch PCM or Mute		Mute
Netflix	WMA	2ch PCM or Mute		2ch PCM or Mute		Mute
CinemaNow	AAC	2ch AAC or PCM or Mute		PCM or Mute		Mute
Blockbuster	AAC	2ch AAC or PCM or Mute		PCM or Mute		Mute
VUDU	Dolby Digital Plus	Dolby Digital Plus or Dolby Digital or Multi PCM*1 or Mute	Dolby Digital or Multi PCM*2 or Mute	Multi PCM*1 or Mute	Multi PCM*2 or Mute	Mute
	MP3	2ch PCM or Mute		2ch PCM or Mute		Mute

*1) Full decoded.

*2) Only the independent substream is decoded.

*3) Dolby TrueHD stream is decoded.

*4) Only the Dolby Digital substream is decoded.

*5) Only the core substream is decoded.

- When playing back a BD-video which only contains the primary audio, the audio output will be the same case as the "Primary Audio Only" even if the "Blu-ray Disc Audio" is set to "Mix Audio Output".

Digital Out

home → "Settings" → "Audio" → "Digital Out"

Refer to the table below to see which setting you should choose.

	"Digital Out" setting →	"Bitstream"		"PCM"	
	"Blu-ray Disc Audio" setting → Audio Source ↓	"Primary Audio Only"	"Mix Audio Output"	"Primary Audio Only"	"Mix Audio Output"
Media ↓					
BD-video	Dolby Digital	Dolby Digital	Dolby Digital	DownMix 2ch PCM	DownMix 2ch PCM
	Dolby Digital Plus	Dolby Digital	Dolby Digital	DownMix 2ch PCM ^{*1}	DownMix 2ch PCM ^{*2}
	Dolby TrueHD	Dolby Digital	Dolby Digital	DownMix 2ch PCM ^{*3}	DownMix 2ch PCM ^{*4}
	DTS®	DTS®	DTS®	DownMix 2ch PCM	DownMix 2ch PCM
	DTS-HD®	DTS®	DTS®	DownMix 2ch PCM ^{*1}	DownMix 2ch PCM ^{*5}
	LPCM	DownMix 2ch PCM	DownMix 2ch PCM	DownMix 2ch PCM	DownMix 2ch PCM
DVD-video	Dolby Digital	Dolby Digital		DownMix 2ch PCM	
	DTS®	DTS®		DownMix 2ch PCM	
	LPCM	2ch PCM		2ch PCM	
DTS-CD	DTS®	DTS®		DownMix 2ch PCM	
AVCHD	Dolby Digital	Dolby Digital		DownMix 2ch PCM	
	LPCM	DownMix 2ch PCM		DownMix 2ch PCM	
DivX®	Dolby Digital	Dolby Digital		DownMix 2ch PCM	
	MP3 / MP2	2ch PCM		2ch PCM	
Audio CD	PCM	2ch PCM		2ch PCM	
MP3	MP3	2ch PCM		2ch PCM	
Windows Media™ Audio	WMA	2ch PCM		2ch PCM	
DLNA Video	Dolby Digital	Dolby Digital		DownMix 2ch PCM	
	MP2	2ch PCM		2ch PCM	
	LPCM	DownMix 2ch PCM		DownMix 2ch PCM	
DLNA Music	MP3 / WMA / LPCM	2ch PCM		2ch PCM	
Netflix	WMA	2ch PCM		2ch PCM	
CinemaNow	AAC	2ch PCM		2ch PCM	
Blockbuster	AAC	2ch PCM		2ch PCM	
VUDU	Dolby Digital Plus	Dolby Digital	Dolby Digital	DownMix 2ch PCM ^{*1}	DownMix 2ch PCM ^{*2}
	MP3	2ch PCM		2ch PCM	

*1) Full decoded.

*2) Only the independent substream is decoded.

*3) Dolby TrueHD stream is decoded.

*4) Only the Dolby Digital substream is decoded.

*5) Only the core substream is decoded.

- When playing back a BD-video which only contains the primary audio, the audio output will be the same case as the "Primary Audio Only" even if the "Blu-ray Disc Audio" is set to "Mix Audio Output".

SETUPS

Ratings Lock

home → "Settings" → "Ratings Lock"

Some BD-video or DVD-video feature a ratings lock level. Playback will stop if the ratings exceed the levels you set, it will require you to enter a password before the disc will play back. This feature prevents your children from viewing inappropriate material.

1) With "Ratings Lock" selected in the "Settings" menu, press [OK].

3D Output	Rating Level
Language	New PIN
Video Output	
Audio	
Ratings Lock	
Network Connection	
Others	
Factory Default	

2) If a PIN code has not been set, proceed to step 2-a). If a PIN code has already been set, proceed to step 2-b). If you want to change the PIN code, proceed to step 2-c). If you forget the PIN code, proceed to step 2-d).

2-a) Enter 4 digit PIN code using [the Number buttons].



- "4737" cannot be used.
- Press [Red] to return to the previous screen.

2-b) Enter 4 digit PIN code using [the Number buttons].

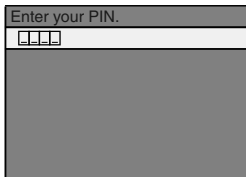

2-c) Follow step 2-b). Select "New PIN", then press [OK]. Enter the new PIN code.
 2-d) Enter "4737". Current PIN code and the "Ratings Lock" settings are now cleared. Follow step 1) and step 2-a) to create a new PIN code.

3) After entering the PIN code, "Rating Level" appears. (If not, use [▲ / ▼] to select "Rating Level".) Select desired rating level then press [OK].

Rating Level	All
New PIN	8 [Adult]
	7 [NC-17]
	6 [R]
	5 [PGR]
	4 [PG-13]
	3 [PG]
	2 [G]

	RATING EXPLANATIONS
All	• Ratings Lock Control is inactive; all discs can play back.
8 [Adult]	• DVD software of any grades (adult / general / children) can be played back.
7 [NC-17]	• No one under 17 admitted.
6 [R]	• Restricted; under 17 requires accompanying parent or adult guardian.
5 [PGR]	• Parental Guidance Recommended.
4 [PG-13]	• Unsuitable for children under 13.
3 [PG]	• Parental Guidance suggested.
2 [G]	• General Audience.
1 [Kid Safe]	• Suitable for children.

To cancel ratings lock temporarily

Some discs allow you to cancel the ratings lock temporarily. With those discs, the message below will appear when you try to play them back. "Please enter your PIN to unblock content." Follow the instruction which appears on the TV screen to cancel the ratings lock. After entering the PIN code, "Rating Level" appears.

Select desired rating level, then press [OK].

Network Connection

home → "Settings" → "Network Connection"

Set up network connection settings in order to use BD-Live, DLNA home media server, Netflix / CinemaNow / Blockbuster / VUDU or network upgrade function.

Connection Test

After you enable a network connection or change the network settings, always perform the connection test to check if the connection is correctly made.

- 1) Use [▲ / ▼] to select "Settings" in the home menu, then press [OK].
- 2) Use [▲ / ▼] to select "Network Connection", then press [OK].
- 3) Use [▲ / ▼] to select "Connection Test", then press [OK].

Connection test will start automatically and the test result will appear right after the connection test finishes.

- "Testing...": The test is in progress.
- "Pass": Connection test is successfully completed.
- "Fail": Connection test failed. Check the connection settings.

If the connection test passes, press [OK].

- Confirmation screen of the network selection will appear. e.g.) Wired connection

Network Selection	Wired
	then press 'OK'.

Press [OK] again to display the confirmation screen of network settings.

IP Address	xxx.xxx.xxx.xxx
Subnet Mask	xxx.xxx.xxx.xxx
Default Gateway	xxx.xxx.xxx.xxx
Primary DNS	xxx.xxx.xxx.xxx
Secondary DNS	xxx.xxx.xxx.xxx
	then press 'OK'.

- 4) Press [OK] to go back to the previous screen, or press [⬆️ (home)] to go back to the home menu.

Note

- If the connection test passes, you are ready to use BD-Live, DLNA home media server, Netflix / CinemaNow / Blockbuster / VUDU or network upgrade function, using the Internet without making any additional settings.
- If the connection test fails, you may need to change the MAC address settings on your router. You can check the MAC address of this unit on "Network Status" screen (refer to page 60).
- When connecting this unit directly to a modem for the first time or connecting it to a modem which was previously connected to any other network device (e.g. a router, PC, etc.), you may have to power cycle the modem to reset the settings on the modem.

Wired Connection

Select "Wired Connection" if you made a wired connection and set the setting to "Standard"(wired) or "Manual"(wired), in accordance with your network environment.

Standard (Wired)

Network settings are set to the following settings initially. (In most cases, you can connect to the Internet without making any changes to the default settings.)

- IP Address Setting Auto(DHCP)
- DNS Setting Auto(DHCP)
- Proxy Setting Do Not Use
- Connection Speed Auto
- BD-Live Setting Allow

If you want to set the network settings back to the default settings as above (except "BD-Live Setting"), follow the procedure below.

- 1) Follow steps 1) to 2) in "Connection Test" on page 57.
- 2) Use [▲ / ▼] to select "Network Selection", then press [OK].
- 3) Use [▲ / ▼] to select "Wired Connection", then press [OK].
- 4) Use [▲ / ▼] to select "Standard", then press [OK].
 - The unit will start the connection test automatically.
 - If the connection test passes, press [OK] to go back to the home menu.
 - If the connection test fails, press [OK] to go back to the previous screen. Please verify your settings and try again.

Note

- The setting of "BD-Live Setting" will not be set back to the default, even if you follow the procedure.

SETUPS

Manual (Wired)

In following cases, select “Manual”(wired) to set each setting as necessary.

- When connection test failed with the setting of “Standard”(wired).
- When instructed by your Internet service provider to make specific settings in accordance with your network environment.

To set the network setting to “Manual”(wired), follow the following procedure.

1) Follow steps 1) to 3) in “Standard (Wired)” on page 57.

2) Use [▲ / ▼] to select “Manual”, then press [OK].

- Setting menu of “Manual”(wired) will be displayed. Set each setting as necessary.

IP Address Setting / DNS Setting

1) Use [▲ / ▼] to select “IP Address Setting”, then press [OK].

2) Use [▲ / ▼] to select the desired setting, then press [OK].

“Auto(DHCP)”	: If your router has DHCP server function, select “Auto(DHCP)”.
“Manual”	: If your router does not have DHCP server function, select “Manual”.

If you select “Manual”, follow the following instruction to set the IP address and DNS.

2-a) IP address setting screen will appear. Enter IP address, subnet mask and default gateway with cursor buttons and number buttons.

- Enter the IP address number after checking the specifications of your router.
- If the IP address is unknown, check the IP address of other devices. (e.g. PC connected via LAN cable) and assign a different number from those of other devices.

After you enter all correctly, press [OK] to go to the DNS setting screen.

2-b) DNS setting screen will appear. Enter primary DNS and secondary DNS with cursor buttons and number buttons.

- Enter the DNS addresses provided by your Internet provider.
- If the DNS address is unknown, check the DNS address of other devices (e.g. PC connected via LAN cable) and assign the same DNS address.

2-c) After you enter all correctly, press [OK].

- Confirmation message will appear. Select “Yes” to complete the settings.

IP Address	xxx.xxx.xxx.xxx
Subnet Mask	xxx.xxx.xxx.xxx
Default Gateway	xxx.xxx.xxx.xxx
Primary DNS	xxx.xxx.xxx.xxx
Secondary DNS	xxx.xxx.xxx.xxx
	Is Setting OK?
	Yes
	No

3) Press [BACK ↩] to go back to the previous screen, or press [⬆ (home)] to go back to the home menu.

Note

- The range of input numbers is between 0 and 255.
- If you enter a number larger than 255, the number will automatically be 255.
- The manually entered addresses will be saved even if you change the setting to “Auto(DHCP)”.
- When you enter a wrong number, press [Red] to cancel. (the number will be back to “0”.)
- If you want to enter 1 or 2 digit number in one cell, press [▶] to move on to the next cell.
- If the entered IP address or the default gateway or primary DNS address is same as the default setting, IP address setting will be set to “Auto(DHCP)”. (The manually entered number will be saved).
- When IP address setting is set to “Manual”, the setting of DNS setting will automatically be “Manual” and when IP address setting is set to “Auto(DHCP)”, you can set either “Auto(DHCP)” or “Manual” for DNS setting.

Proxy Setting

- 1) Use **[▲ / ▼]** to select “Proxy Setting”, then press **[OK]**.
- 2) Use **[▲ / ▼]** to select the desired setting, then press **[OK]**.
 - For default settings, select “Do Not Use”.
 - If you need to change the proxy setting as instructed by your Internet service provider to set the designated proxy address and port, select “Use”.

If you select “Use”, follow the following instructions to set the proxy address and proxy port.

- 2-a) Proxy address setting screen will appear.
 - Enter proxy address.
 - The keyboard screen will appear.

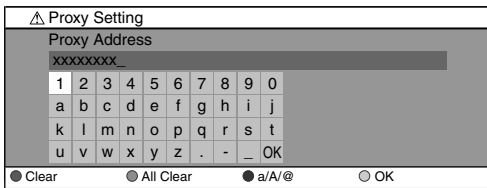

[▲ / ▼ / ◀ / ▶] : Move the highlight.
[the Number buttons] : Enter number.
[OK] : Enter the highlighted number / word.
***[Red]** : Clear the entered number or word.
[Green] : Clear all the entered numbers or words.
[Blue] : Switch between abc, ABC and @!?
***[Yellow]** : Set the entered number or word.
 * These buttons can be used in other network settings.

After you enter all correctly, press [Yellow] to go to the proxy port setting screen.

- 2-b) Enter proxy port number with number buttons.



- 2-c) After you enter all correctly, Press **[Yellow]**.
 - Confirmation message will appear. Select “Yes” to complete the settings.

Proxy Address	xxxxxxxxxxxxxxxx
Proxy Port	xxxxx
	Is Setting OK?
	Yes
	No

- 3) Press **[BACK ↶]** to go back to the previous screen, or press **[⬆ (home)]** to go back to the home menu.

Note

- The range of input numbers for the port number is between 0 and 65535. (If you enter a number larger than 65535, it will be regarded as 65535.)
- For proxy port, certain ports might be closed, blocked or unusable depending on your network environment.

Connection Speed

You can set connection speed as your preference. (The default setting is “Auto”.)

- 1) Use **[▲ / ▼]** to select “Connection Speed”, then press **[OK]**.
- 2) Use **[▲ / ▼]** to select the desired setting, then press **[OK]**.

“Auto”:

Set the appropriate connection speed automatically, in accordance with your network environment.

“10BASE Half”:

Set the connection speed to “10BASE Half”.

“10BASE Full”:

Set the connection speed to “10BASE Full”.

“100BASE Half”:

Set the connection speed to “100BASE Half”.

“100BASE Full”:

Set the connection speed to “100BASE Full”.

- 3) Press **[BACK ↶]** to go back to the previous screen, or press **[⬆ (home)]** to go back to the home menu.

Note

- Choose a connection speed in accordance with your network environment.
- The network connection may be disabled depending on the device, when the settings are changed.

SETUPS

BD-Live Setting

You can limit Internet access for BD-Live discs.
(The default setting is "Allow".)

- 1) Use [▲ / ▼] to select "BD-Live Setting", then press [OK].
- 2) Use [▲ / ▼] to select the desired setting, then press [OK].

"Allow":

Internet access is permitted for all BD-Live contents.

"Limited Allow":

Internet access is permitted only for BD-Live contents which have content owner certificates. Internet access without the certificates is prohibited.

"Prohibit":

Internet access is prohibited for all BD-Live contents.

- 3) Press [BACK ↵] to go back to the previous screen, or press [⬆️ (home)] to go back to the home menu.

Network Status

You can check the status of network settings.

- 1) Use [▲ / ▼] to select "Network Status", then press [OK].
 - Network setting list will be displayed.
 - MAC address of this unit will be displayed in the list.
- 2) Press [BACK ↵] to go back to the previous screen, or press [⬆️ (home)] to go back to the home menu.

Wireless Connection

If you connect this unit to the network wirelessly, select "Wireless Connection" and set up necessary settings.

Wireless Router

In order to use a wireless network, you must set up the connection to the wireless router.

Find wireless network

Search for wireless networks automatically and select the wireless network name (SSID) from the list.

- 1) Follow steps 1) to 2) in "Standard (Wired)" on page 57.
- 2) Use [▲ / ▼] to select "Wireless Connection", then press [OK].
- 3) Use [▲ / ▼] to select "Wireless Router", then press [OK].
- 4) Use [▲ / ▼] to select "Find wireless network", then press [OK].
 - This unit will start searching for wireless networks automatically.

- 5) The list of wireless networks will be displayed. Use [▲ / ▼] to select the appropriate wireless network name (SSID), then press [OK].

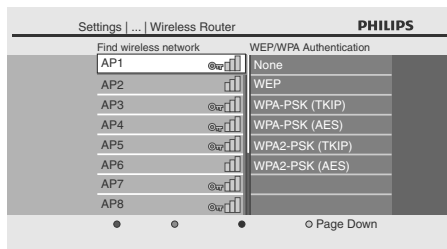

- 6) Use [▲ / ▼] to select the authentication setting of the selected wireless network.
 - For a wireless network with authentication setting, select the authentication setting, according to the security type of the wireless network.
 - For a wireless network without authentication setting, select "None".

"None":

Set the authentication setting to "None".

"WEP":

Set the authentication setting to "WEP".

"WPA-PSK (TKIP)":

Set the authentication setting to "WPA-PSK (TKIP)".

"WPA-PSK (AES)":

Set the authentication setting to "WPA-PSK (AES)".

"WPA2-PSK (TKIP)":

Set the authentication setting to "WPA2-PSK (TKIP)".

"WPA2-PSK (AES)":

Set the authentication setting to "WPA2-PSK (AES)".

- If you select "WEP", "WPA-PSK (TKIP)", "WPA-PSK (AES)", "WPA2-PSK (TKIP)" or "WPA2-PSK (AES)", "WEP/WPA Key" entry screen will appear. Enter the WEP/WPA key of the selected wireless network using cursor buttons, number buttons and color key, then press [Yellow].

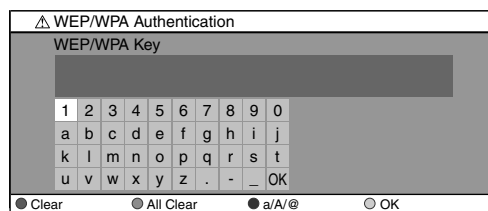

- Confirmation message will appear. Select "Yes" to complete the settings.

SSID	AP1
WEP/WPA Authentication	WPA2-PSK (AES)
WEP/WPA Key	xxxxxxxxxxxxxxxxxxxxx...
	Is Setting OK?
	Yes
	No

- 7) **Following screen will appear. Use [◀/▶] to select "Yes", then press [OK] to go to "Advanced Settings".**
- For further operation, refer to "Advanced Settings" on page 61.
 - To go back to the home menu, press [⬆️ (home)].

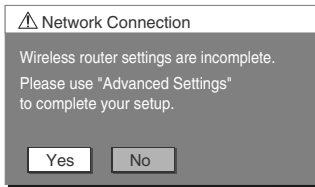

Note

- For a wireless network with authentication setting, key icon appears to the right hand of the wireless network name (SSID).
- Signal icon shows the strength of the signal.
- WEP/WPA key appears as asterisks on the confirmation screen.
- The internal Wireless LAN supports following specifications.
 - Wireless standards : IEEE 802.11 b/g/n
 - Frequency spectrum : 2.4GHz
 - Security protocol : WEP / WPA / WPA2

Manually enter your SSID

Set up the connection to the wireless router manually by entering the wireless network name (SSID).

- 1) **Follow steps 1) to 3) in "Find wireless network" on pages 60-61.**
- 2) **Use [▲ / ▼] to select "Manually enter your SSID", then press [OK].**
 - Wireless Router Name (SSID) entry screen will appear. Enter the wireless network name (SSID) using cursor buttons, number buttons and color key, then press [Yellow].

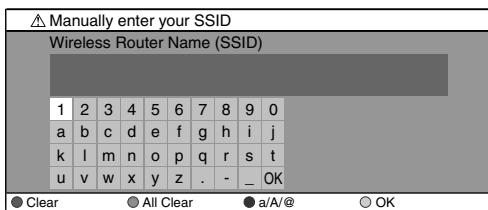

- 3) **Follow steps 6) to 7) in "Find wireless network" on pages 60-61.**

Wireless Router Status

You can check the current status of "Wireless Router" setting.

- 1) **Follow steps 1) to 3) in "Find wireless network" on pages 60-61.**
- 2) **Use [▲ / ▼] to select "Wireless Router Status", then press [OK].**
 - The list of current wireless router setting will be displayed.
- 3) **Press [BACK ↵] to go back to the previous screen, or press [⬆️ (home)] to go back to the home menu.**

Advanced Settings

After you set up the "Wireless Router" setting, set the network setting to "Standard" (wireless) or "Manual"(wireless).

Standard (wireless)

To set the network setting to "Standard"(wireless), follow the following procedure. For details of this setting, refer to "Standard (Wired)" on page 57.

- If you select "Yes" in step 7) of "Find wireless network" on pages 60-61, skip to step 3).

- 1) **Follow steps 1) to 2) in "Find wireless network" on pages 60-61.**

- 2) **Use [▲ / ▼] to select "Advanced Settings", then press [OK].**

- 3) **Use [▲ / ▼] to select "Standard", then press [OK].**

Manual (wireless)

To set the network setting to "Manual"(wireless), follow the following procedure.

- If you select "Yes" in step 7) of "Find wireless network" on pages 60-61, skip to step 3).

- 1) **Follow steps 1) to 2) in "Find wireless network" on pages 60-61.**

- 2) **Use [▲ / ▼] to select "Advanced Settings", then press [OK].**

- 3) **Use [▲ / ▼] to select "Manual", then press [OK].**

- For details of each setting, refer to following pages.
 - "IP Address Setting" / "DNS Setting": Refer to "IP Address Setting / DNS Setting" on page 58.

- "Proxy Setting": Refer to "Proxy Setting" on page 59.

- "BD-Live Setting": Refer to "BD-Live Setting" on page 60.

- "Network Status": Refer to "Network Status" on page 60.

Note

- You cannot select "Advanced Settings" if "Wireless Router" setting is not completed.

Disable

Deactivates all the network connection and settings.

- 1) **Follow steps 1) to 2) in "Standard (Wired)" on page 57.**

- 2) **Use [▲ / ▼] to select "Disable", then press [OK].**

- 3) **Use [▲ / ▼] to select "Yes", then press [OK].**

- 4) **Press [BACK ↵] to go back to the previous screen, or press [⬆️ (home)] to go back to the home menu.**

Note

- The network connection can be reactivated by setting the network connection to "Wired Connection" or "Wireless Connection".

EasyLink (HDMI CEC)

home → "Settings" → "Others" → "EasyLink (HDMI CEC)"

This unit supports Philips EasyLink, which enables your TV (limited to PHILIPS brand EasyLink TV) to act in conjunction with this unit, or vice versa. Compliant TV must be connected to the HDMI OUT jack.

When "EasyLink (HDMI CEC)" setting is set to "On", functions listed below will be available.

One Touch Play

When the operations with following buttons of the remote control of this unit are performed, the TV will automatically be turned on and switched to the appropriate input channel.

Buttons for one touch play:

- [▶ (play)], [◀ (previous)], [▶ (next)], [the Number buttons], [▲ (home)], or [INFO ⓘ]
- [TOP MENU], or [DISC MENU / POP-UP MENU] (when a disc is inserted in the unit)

Standby

When you press and hold [⏻ (standby/on)] for 2 seconds, it turns off the power of the TV first and then turns off the power of this unit also.

System Information

Get & Set Menu Language

The unit recognizes the OSD language set for the TV and automatically sets the same language as the player menu language (OSD menu language) for this unit. Refer to the "Player Menu" on page 45 for available languages.

- This feature is available only when "Auto" is selected in the "Player Menu" in the settings menu.

Software Upgrade

home → "Settings" → "Others" → "Software Upgrade"

Philips continuously tries to improve its products and we strongly recommend that you upgrade the software when upgrades are available. New software can be downloaded from our website at www.philips.com using the type number of your Blu-ray Disc Player (e.g. BDP7520) to find information.

Disc Upgrade

You can upgrade the software by using disc.

- 1) Follow step 1) in "Connection Test" on page 57.
- 2) Use [▲ / ▼] to select "Others", then press [OK].
- 3) Use [▲ / ▼] to select "Software Upgrade", then press [OK].
- 4) Use [▲ / ▼] to select "Disc Upgrade", then press [OK].
- 5) Use [▲ / ▼] to select "Yes", then press [OK].
- 6) Disc tray will open automatically.
 - Insert the disc for software upgrade and then press [▲ (open/close)].

- 7) After completing loading disc, confirmation message will appear. Use [◀ / ▶] to select "Yes" and press [OK] to start upgrading.

- It may take a while to complete the upgrading.

- 8) After the disc upgrade finishes, this unit will restart and open the disc tray automatically. Remove the disc.

Note

- Please visit www.philips.com to download the latest software version. Please read the software upgrade Read-me file carefully before performing an upgrade using a disc.
- Please do not unplug the AC power cord while executing the "Disc Upgrade".
- All settings will remain the same even if you upgrade the software version.
- The version of Netflix will also be upgraded if newer version of Netflix is available when upgrading the software.

Network Upgrade

You can upgrade the software by connecting the unit to the Internet.

- 1) Follow step 1) in "Connection Test" on page 57.
- 2) Use [▲ / ▼] to select "Others", then press [OK].
- 3) Use [▲ / ▼] to select "Software Upgrade", then press [OK].
- 4) Use [▲ / ▼] to select "Network Upgrade", then press [OK].
- 5) Use [▲ / ▼] to select "Yes", then press [OK].
 - This unit will then start checking for the latest software version.
- 6) Confirmation message will appear. Use [◀ / ▶] to select "Yes", then press [OK].
 - The unit will start downloading the latest software version.
- 7) When the download completes, confirmation message will appear. Press [OK].
 - The unit will start upgrading the software version.
 - It may take a while to complete the upgrading.
- 8) After upgrading finishes, this unit will restart and open the disc tray automatically.

Note

- In order to upgrade the software via the Internet, you must connect the unit to the Internet and set up necessary settings.
- For the network connection, refer to "Connection to the Network" on page 20.
- For the network setup, refer to "Network Connection" on page 57.
- Please do not unplug the AC power cord or LAN cable while executing the "Network Upgrade".
- All settings will remain the same even if you upgrade the software version.
- The disc tray will open automatically after upgrading finishes. This is not a malfunction.
- The version of Netflix will also be upgraded if newer version of Netflix is available when upgrading the software.

Reset to Factory Default

home → "Settings" → "Factory Default"

Menus to reset player settings, format SD card, local storage, clear network settings and deactivate Netflix or VUDU.

- 1) Use [▲ / ▼] to select **"Settings"** in the home menu, then press [OK].
- 2) Use [▲ / ▼] to select **"Factory Default"**, then press [OK].
- 3) Use [▲ / ▼] to select the desired setting, then press [OK].
 - "Settings":**
All the settings except for the "Ratings Lock" and "Network Connection" setting will be reset to default.
 - "Format SD Card" (Available only when an SD Memory Card is inserted):**
Initialize the SD Memory Card.
 - "Local Storage":**
Local storage for Player or SD card (Available only when an SD Memory Card is inserted) used for BD-Java will be initialized.
 - "Network Settings":**
Reset the network setting to the default.
 - "Netflix Deactivate":**
Deactivates the connection to Netflix.
 - "Vudu Deactivate":**
Deactivates the connection to VUDU.
- 4) Use [▲ / ▼] to select **"Yes"**, then press [OK].
 - Confirmation message will appear. Press [OK] to complete the setting.
- 5) Press [BACK ↵] to go back to the previous screen, or press [⬆ (home)] to go back to the home menu.

Note

- Do not remove the SD Memory Card while executing the "Format SD Card" or "Local Storage" (SD card). It will damage the card.
- "Format SD Card" and "Local Storage" (SD card) are not available when a Blu-ray Disc is in the unit.

TROUBLESHOOTING

	Problem	Tip
POWER	No reaction to the remote control.	<p>Connect the product to the power outlet.</p> <p>Point the remote control at the product.</p> <p>Insert the batteries correctly.</p> <p>Insert new batteries in the remote control.</p>
	No video signal on the display device.	<p>Turn on the TV.</p> <p>Set the TV to the correct external input.</p> <p>Select the correct video resolution using [HDMI].</p> <p>Press and hold [▶ (play)] on the front panel for 5 seconds to change the setting back to its default.</p>
	No audio / video signal on the display device via HDMI cable.	<p>If the unit is connected to the unauthorized display device with an HDMI cable, the audio / video signal may not be output.</p> <p>Perform an HDMI cable hotplug, wherein you disconnect the HDMI cable from the TV and this unit and then reconnect it to both the devices while they are powered on.</p> <p>Ensure that your HDMI cable is certified.</p>
	No high-definition video signal on the TV.	<p>Does the disc contain high-definition video? High-definition video is not available when the disc does not contain it.</p> <p>Does the TV support high-definition video? High-definition video is not available when the TV does not support it.</p>
	No 3D video on the TV.	<p>Check if your TV is 3D capable.</p> <p>Use HDMI 1.4 cable to connect the 3D capable TV.</p> <p>Set "3D Output" to "Auto (XX)". (Refer to page 45.)</p> <p>Wear 3D glasses and make sure they are switched on and in sync with your TV.</p> <p>Check the battery levels of your glasses.</p> <p>Refer to your 3D TV's user manual for more information.</p>
	No audio signal from the loudspeakers of the TV.	<p>Assign the audio input of the TV to the corresponding video input.</p> <p>Ensure that the TV's speakers are turned on in the TV menu.</p> <p>Ensure that the TV speakers are not muted.</p>
	No audio signal from the loudspeakers of the audio system.	<p>Turn on the audio system.</p> <p>Set the audio system to the correct external input.</p> <p>Increase the volume level of the audio system.</p>
GENERAL	Cannot play back a disc.	<p>Make sure that the product supports the disc.</p> <p>Check the region code of the disc. This unit supports following region codes.</p> <p>-BD : "A"</p> <p>-DVD : "ALL" or "1" for BDP7520/F7 (USA / Canada)</p> <p>"ALL" or "4" for BDP7520/F8 (Mexico)</p> <p>For DVD-RW/-R, make sure that the disc is finalized.</p> <p>Clean the disc.</p>
	SD Memory Card cannot be read.	The format of the card does not match that accepted by this unit or the card is not compatible.
	Cannot play back JPEG files from a disc.	Make sure that the disc was recorded in the UDF, ISO9660 or JOLIET format.
	Cannot play back MP3 files from a disc.	<p>Make sure that the disc was recorded in the UDF, ISO9660 or JOLIET format.</p> <p>Make sure that the bit rate of the MP3 files is between 112 and 320 kbps.</p> <p>Make sure that the sample rate of the MP3 files is 32 kHz, 44.1 kHz or 48 kHz.</p>
	Cannot play back Windows Media™ Audio files from a disc.	Make sure that the sample rate of the Windows Media™ Audio files is 44.1 kHz or 48 kHz.
	Cannot play back DivX® files from a disc.	<p>Make sure that the file extension is .avi, .AVI, .divx or .DIVX.</p> <p>Ensure that the DivX® video on the disc meets the DivX® playback capabilities of this device outlined on page 27.</p>

TROUBLESHOOTING

EN

Problem	Tip
✘ in the upper right hand corner of the TV screen.	The operation is not possible.
Buttons do not work or the unit stops responding.	To completely reset the unit, press and hold [⏻ (standby/on)] on the front panel for 10 seconds to shut down the unit or unplug the AC cord from the AC outlet for 5-10 seconds.
Cannot find a JPEG file.	Make sure that the selected group (folder) does not contain more than 9,999 files for BD / DVD / SD card, and 999 files for CD.
	Make sure that the file extension is .jpg, .JPG, .jpeg or .JPEG.
Cannot find an MP3 and Windows Media™ Audio file.	Make sure that the selected folder does not contain more than 9,999 files for BD / DVD / SD card, and 999 files for CD.
	Make sure that the file extension is .mp3 or .MP3 for MP3, and .wma or .WMA for Windows Media™ Audio.
Error message appears when I select "Auto" in the "Player Menu".	Make sure that the unit is connected to the PHILIPS brand EasyLink TV and the "EasyLink (HDMI CEC)" is set to "On".
	This error message may appear when your TV's OSD language is not supported by this unit.
Cannot connect to the network.	Check if the network connection is properly made.
	Turn on the modem or router.
	Check the network settings.
	Check if the router and/or modem is correctly connected.
	Check the "BD-Live Setting".
	When connecting directly to a modem via a LAN cable, you might need to power cycle the modem to reset settings on the modem.
Cannot use the wireless connection.	Once you have activated the wireless connection please wait 30 seconds for the connection to be established after turning on the unit, before trying to access network features such as BD-Live, DLNA, Netflix, CinemaNow, Blockbuster or VUDU.
Cannot get into the PC's screen after "MediaConnect" is selected.	The startup screen (PHILIPS logo with spinning circle) keep displaying until the unit found the PC that is running Philips Wireless MediaConnect.
	Make sure if the network connection is connected properly.
	Check if your PC runs Philips Wireless MediaConnect.
	Make sure your TV and PC are connected on the same network.
Cannot connect to the network while my PC is connected to the network.	Check the content of your Internet service contract to see if your Internet Service Provider prevents multiple terminals connecting at the same time.
The capacity of the SD card decreased.	Data may be written to the SD card when a BD-video that supports the virtual package is used and an SD card is in the slot.
MPEG-2 video and audio on the SD card cannot be played back.	MPEG-2 is noncompliant on this unit.
The contents of the card cannot be read.	The card is not compatible or the contents on the card may be damaged. Turn off and then turn the unit on again.
Cannot use the BD-Live function or download of data does not perform properly.	Insert an SD card with enough capacity(1GB or more). Check if an SD card is correctly inserted.
	Make sure the write-protect switch on the SD card is not enabled.
Cannot play back BD-video(BD-ROM Profile 2.0).	Insert an SD card(1GB or more) which is formatted on this unit. Some discs with BD-Live function require memory when playing back the content.
	Do not remove the card during playback.
	Make sure the write-protect switch on the SD card is not enabled.
Folder or files stored on DLNA home media server are not displayed in the file list or cannot be played back.	Check the setting on your home media server. (Refer to the user manual of the home media server.) Check the network connection and settings.
Cannot use Netflix feature.	Netflix is available only in the United States.
	Check if the network connection is properly made.
	Visit netflix.com/Philips on your PC and become a Netflix member.
	Visit netflix.com on your PC.
Cannot add movies or TV episodes to the instant Queue.	Adding movies or TV episodes on this unit is not available.

GENERAL

Introduction

Connections

Basic Setup

Playback

Function Setup

Others

TROUBLESHOOTING

Problem	Tip
Even though the speed of the Internet connection improves during playback, the picture quality of Netflix streaming movie does not improve.	The picture quality does not change during playback. The picture quality differs depending on the speed of Internet connection at the time of loading.
The picture quality of streaming movie (Netflix, CinemaNow or Blockbuster) is poor.	Check the speed of your Internet connection.
Streaming movie (Netflix, CinemaNow or Blockbuster) often stops or start buffering during playback.	Contact your Internet service provider. (You may need to improve the broadband speed.)
Cannot use CinemaNow / Blockbuster feature.	Check if the network connection is properly made. Visit www.cinemanow.com/Login (CinemaNow) or www.blockbuster.com/auth/login (Blockbuster) on your PC and create an account.
Cannot use the VUDU service.	Check if the network connection is properly made.
Cannot rent or buy movies / TV shows on VUDU.	You need to activate the VUDU account. (Refer to page 43) Log into your account at http://my.vudu.com and check your payment information.
The picture quality of VUDU movie is poor.	Check the speed of your Internet connection. You need speeds of at least 8 Mbps to this player for high quality uninterrupted playback.
VUDU movie often stops or starts buffering during playback.	Contact your Internet service provider to troubleshoot your Internet connection for speed and line quality. Consistent line quality and speed are very important for Internet video playback.

GENERAL

Downloading an Electronic Copy

To obtain an electronic copy of this manual :

- 1) **Point your browser to www.philips.com/support.**
- 2) **Choose your country of location.**
- 3) **Enter the model number or a keyword in the "Find your product" field. Alternatively, you can browse the catalog.**
- 4) **Click the description or model.**
- 5) **Under Product support, click "User manuals".**

Contact Us

If you cannot resolve your problem, refer to the FAQ for this Blu-ray Disc Player at www.philips.com/support.
If the problem remains unresolved, contact the Customer Support Center in your country.

Note

- Do not attempt to repair the Blu-ray Disc Player yourself. This may cause severe injury, irreparable damage to your Blu-ray Disc Player or void your warranty.
- Please have available your Blu-ray Disc Player model and serial number before contacting us. These numbers are available on the cabinet, as well as on the packaging.

Analog Audio

An electrical signal that directly represents sound. Compare this to digital audio which can be an electrical signal, but is an indirect representation of sound. See also "Digital Audio".

Aspect Ratio

The width of a TV screen relative to its height. Conventional TVs are 4:3 (in other words, the TV screen is almost square); widescreen models are 16:9 (the TV screen is almost twice as wide as it is high).

AVCHD

AVCHD is a new format for high definition video camcorders which can record and play high-resolution HD images.

BD-Live

BD-Live is a BD-video (BD-ROM version 2 Profile 2.0) which contains new functions (e.g. Internet connection), in addition to the BONUSVIEW function.

Blockbuster

Blockbuster is online service which you can rent or purchase movies and TV episodes streamed over the Internet.

Blu-ray Disc (BD)

Blu-ray Disc is a next generation optical video disc which is capable of storing much more data than a conventional DVD. The large capacity makes it possible to benefit from the features such as high-definition videos, multi-channel surround sounds, interactive menus and so on.

Chapter

Just as a book is split up into several chapters, a title on a BD-video or DVD-video is usually divided into chapters. See also "Title".

CinemaNow

CinemaNow is online service which you can rent or purchase movies and TV episodes streamed over the Internet.

Component Video Output

Each signal of luminance (Y) and component (P_B/C_B, P_R/C_R) is independent to output so that you can experience picture color as it is.

Also, due to compatibility with progressive video (525p/480p), you can experience higher-density picture than that in interlace (525i/480i).

Digital Audio

An indirect representation of sound by numbers. During recording, the sound is measured at discrete intervals (44,100 times a second for CD audio) by an analog-to-digital converter, generating a stream of numbers. On playback, a digital-to-analog converter generates an analog signal based on these numbers. See also "Sampling Frequency" and "Analog Audio".

DivX®

DivX® is a codec (compression/decompression) that can compress pictures to a very small amount of data. The software can compress video data from almost any devices to the size that can be sent on the Internet without compromising visual quality of the pictures.

DLNA (Digital Living Network Alliance)

DLNA is a cross-industry organization of consumer electronics that formulates DLNA Interoperability Guidelines for sharing digital contents within a home network.

DNS Server

A server which translates Internet domain names into IP addresses.

Dolby Digital

The system to compress digital sound developed by Dolby Laboratories. It offers you sound of stereo (2ch) or multi-channel audio.

Dolby Digital Plus

Dolby Digital Plus is the next generation digital audio compression technology developed as an extension to Dolby Digital. Blu-ray Disc supports 7.1 multi-channel surround sound output.

Dolby TrueHD

Dolby TrueHD is a lossless coding technology developed for next generation optical discs. Blu-ray Disc supports 7.1 multi-channel surround sound output.

DTS® (Digital Theater System)

DTS® is a multi channel surround sound system. You can enjoy movie dynamic and realistic sound like movie theater. DTS surround sound technologies were developed by DTS, Inc.

DTS-HD®

DTS-HD® is a lossless coding technology developed as an extension of the original DTS Coherent Acoustics format. Blu-ray Disc supports 7.1 multi-channel surround sound output.

GLOSSARY

Gateway

IP address of the electronic devices (such as router) which provide Internet access.

HDMI (High Definition Multimedia Interface)

A digital interface between audio and video source. It can transmit component video, audio, and control signal with one cable connection.

Hub

A device used for connecting multiple device to the network.

IP Address

A set of numbers which are assigned to devices participating in a computer network.

JPEG (Joint Photographic Experts Group)

JPEG is a method of compressing still picture files. You can copy JPEG files on CD-RW/-R, DVD-RW/-R, BD-RE/-R or SD Memory Card from a computer and play back the files on this unit.

LAN (Local Area Network)

A group of computer networks covering a small area like a company, school or home.

Local Storage

A storage area of sub contents for playing virtual packages on BD-video.

MP3 (MPEG audio layer 3)

MP3 is a method of compressing files. You can copy MP3 files on CD-RW/-R, DVD-RW/-R, BD-RE/-R or SD Memory Card from the computer and play back the files on this unit.

Netflix

Netflix is online movie rental service, offering online streaming to customers in the United States.

PCM (Pulse Code Modulation)

The most common system of encoding digital audio, found on CD and DAT. Excellent quality, but requires a lot of data compared to formats such as Dolby Digital and MPEG audio. For compatibility with digital audio recorders (CD, MD and DAT) and AV amplifiers with digital inputs, this unit can convert Dolby Digital, DTS, and MPEG audio to PCM. See also "Digital Audio".

Proxy Server

Proxy server is a server which acts as an intermediary between a workstation user and the Internet to ensure security.

Region Code

Regions associate discs and players with particular areas of the world. This unit will only play back discs that have compatible region codes. You can find the region code of your unit by looking on the rear panel. Some discs are compatible with more than one region (or all regions).

Router

A networking device which distinguishes the IP address assigned to each device and routing and forwarding information in the computer network.

Sampling Frequency

The rate which sound is measured by a specified interval to turn into digital audio data. The numbers of sampling in one second defines as sampling frequency. The higher the rate, the better the sound quality.

Subnet Mask

A mask which is used to determine what subnet an IP address belongs to.

Title

A collection of chapters on BD-video or DVD-video. See also "Chapter".

Track

Audio CD uses tracks to divide up the content of a disc. The BD-video or DVD-video equivalent is called a chapter. See also "Chapter".

Virtual Package

The function which copies data to other media (local storage) from the Internet and plays secondary video, secondary audio and subtitles at the same time. The method of the playback varies depending on discs.

VUDU

VUDU is a leading HD on-demand video service which utilizes the Internet connection to deliver the highest quality on-demand video and Internet applications.

Windows Media™ Audio

Windows Media™ Audio is the audio compressing technology developed by Microsoft. You can copy Windows Media™ Audio files on CD-RW/-R, DVD-RW/-R or SD Memory Card from a computer and play them back on this unit.

x.v.Color

"x.v.Color" is a promotion name given to the products that have the capability to realize a wide color space based on the xvYCC specifications and is a trademark of Sony Corporation.

SPECIFICATIONS

General

Signal System	NTSC Color
Power requirements	120 V AC, 60 Hz
Power consumption	17 W (standby: 0.5 W)
Dimensions (width x height x depth)	17.2 x 2.0 x 8.5 inches (435 x 50 x 215 mm)
Weight	4.6 lbs. (2.1 kg)
Operating temperature	41°F (5°C) to 104°F (40°C)
Operating humidity	Less than 80 % (no condensation)

Terminals

Front	SD card slot			
	slot x 1			
Rear	Audio output (Analog)			
	RCA jack x 2	L/R: 2 Vrms (output impedance: more than 1kΩ)		
	Video output			
	RCA jack x 1	1 Vp-p (75Ω)		
	Component video output			
	RCA jack x 3	Y: 1 Vp-p (75Ω)	P _B /C _B : 700 mVp-p (75Ω)	P _R /C _R : 700 mVp-p (75Ω)
	Audio output (Digital)			
	RCA jack x 1	500 mVp-p (75Ω)		
HDMI output				
HDMI jack x 1	Video: 480p, 720p, 1080i, 1080p, 1080p24/Audio			
LAN terminal	10BASE-T / 100BASE-TX			
Wireless LAN (Internal)	IEEE 802.11 b/g/n			

Note

- The specifications and design of this product are subject to change without notice.

NETWORK SERVICE DISCLAIMER

Network Service Disclaimer

Content and services made available through this product are transmitted by third parties by means of networks and transmission facilities over which Company has no control and third party services may be terminated or interrupted at any time, and Company makes no representation or warranty that any content or service will remain available for any period of time. Without limiting the generality of this disclaimer, Company expressly disclaims any responsibility for any interruption or suspension of any content or service made available through this product. Company is not responsible for customer service related to the content and services. Any question or request for service relating to the content or services should be made directly to the respective content and service providers.

THIRD PARTY CONTENT AND SERVICES MADE AVAILABLE THROUGH THIS PRODUCT ARE PROVIDED "AS IS." COMPANY DOES NOT WARRANT CONTENT OR SERVICES SO PROVIDED, FOR ANY PURPOSE WHATSOEVER. COMPANY EXPRESSLY DISCLAIMS ANY WARRANTIES, EXPRESS OR IMPLIED INCLUDING WITHOUT LIMITATION, WARRANTIES OF MERCHANTABILITY OR FITNESS FOR A PARTICULAR PURPOSE, ACCURACY, VALIDITY, TIMELINESS, LEGALITY, SUITABILITY, OR QUALITY OF ANY CONTENT OR SERVICE MADE AVAILABLE THROUGH THIS PRODUCT.

IN NO EVENT SHALL COMPANY BE LIABLE FOR, ANY DAMAGES, WHETHER ARISING IN CONTRACT OR TORT, INCLUDING WITHOUT LIMITATION, ANY DIRECT, INDIRECT, INCIDENTAL, SPECIAL OR CONSEQUENTIAL DAMAGES, LOST PROFITS, ATTORNEY FEES, EXPENSES, OR ANY OTHER DAMAGES ARISING OUT OF, OR IN CONNECTION WITH, ANY CONTENT (OR ANY INFORMATION CONTAINED THEREIN) OR SERVICE PROVIDED TO THE USER OR ANY THIRD PARTY, EVEN IF ADVISED OF THE POSSIBILITY OF SUCH DAMAGES.

All content and services accessible through this product belong to third parties and are protected by copyright, patent, trademark and/or other intellectual property rights. Such content and services are provided solely for the User's personal noncommercial use. User may not use any content or services in a manner that has not been authorized by the content owner or service provider. Without limiting the foregoing, unless expressly authorized by the applicable content owner or service provider, you may not modify, copy, republish, upload, post, transmit, translate, sell, create derivative works, exploit, or distribute in any manner or medium any content or services made available through this product.

Read the following information before viewing 3D television images.

CAUTION NOTICE:

1. Ambient fluorescent lighting may cause a flickering effect and direct sunlight may adversely affect the operation of your 3D glasses.
2. DO NOT place your television near open stairwells, balconies or other objects as viewing in 3D images may cause disorientation for some viewers resulting in falls, tripping or walking into objects.
3. If you experience (1) altered vision; (2) lightheadedness; (3) dizziness; (4) involuntary movements such as eye or muscle twitching; (5) confusion; (6) nausea; (7) loss of awareness; (8) convulsions; (9) cramps; and/or (10) disorientation, immediately stop watching 3D images and consult your doctor.
4. Parents should regularly monitor their children concerning the above symptoms as children and teenagers may be more likely to experience these symptoms more frequently than adults. Watching 3D television is not recommended for children under the age of 6 as their visual system is not yet fully developed.
5. Prolonged viewing of 3D images might cause discomfort, dizziness, eye strain, headaches or disorientation.

WARNING NOTICE:

1. Some viewers may experience an epileptic seizure or stroke when exposed to certain flashing images or lights contained in certain television pictures or video games. If you or any of your family has a history of epilepsy or stroke, please consult your doctor before viewing 3D images.
2. DO NOT watch 3D television if you are pregnant, elderly, sleep-deprived, suffering from serious medical conditions, in poor physical condition or under the influence of alcohol.
3. Sitting too close to the screen for an extended period of time may damage your eyesight. The ideal distance should be at least three times the height of the TV screen and at the viewer's eyes level.
4. Wearing the 3D glasses for any reason other than viewing 3D television (as general spectacles, sunglasses, protective goggles, etc.) may physically harm you or weaken your eyesight.
5. If you experience any discomfort while viewing 3D images, stop and do not immediately engage in any potentially hazardous activity such as driving a car until your symptoms have disappeared. If your symptoms persist, do not resume watching 3D images without consulting your doctor.

ONE (1) YEAR LIMITED WARRANTY

WARRANTY COVERAGE:

This warranty obligation is limited to the terms set forth below.

WHO IS COVERED:

This product is warranted to the original purchaser or the person receiving the product as a gift against defects in materials and workmanship as based on the date of original purchase ("Warranty Period") from an Authorized Dealer. The original sales receipt showing the product name and the purchase date from an authorized retailer is considered such proof.

WHAT IS COVERED:

This warranty covers new products if a defect in material or workmanship occurs and a valid claim is received within the Warranty Period. At its option, the company will either (1) repair the product at no charge, using new or refurbished replacement parts, or (2) exchange the product with a product that is new or which has been manufactured from new, or serviceable used parts and is at least functionally equivalent or most comparable to the original product in current inventory, or (3) refund the original purchase price of the product. The Company warrants replacement products or parts provided under this warranty against defects in materials and workmanship from the date of the replacement or repair for ninety (90) days or for the remaining portion of the original product's warranty, whichever provides longer coverage for you. When a product or part is exchanged, any replacement item becomes your property and the replaced item becomes the company's property. When a refund is given, your product becomes the company's property. **Note: Any product sold and identified as refurbished or renewed carries a ninety (90) day limited warranty.**

Replacement product can only be sent if all warranty requirements are met. Failure to follow all requirements can result in delay.

WHAT IS NOT COVERED - EXCLUSIONS AND LIMITATIONS:

This Limited Warranty applies only to the new products that can be identified by the trademark, trade name, or logo affixed to it. This Limited Warranty does not apply to any non-Philips hardware product or any software, even if packaged or sold with the product. Non-Philips manufacturers, suppliers, or publishers may provide a separate warranty for their own products packaged with the bundled product.

The Company is not liable for any damage to or loss of any programs, data, or other information stored on any media contained within the product, or any non-Philips product or part not covered by this warranty. Recovery or reinstallation of programs, data or other information is not covered under this Limited Warranty.

This warranty does not apply (a) to damage caused by accident, abuse, misuse, neglect, misapplication, or non-Philips product, (b) to damage caused by service performed by anyone other than an Authorized Service Location, (c) to a product or

a part that has been modified without written permission, or (d) if any serial number has been removed or defaced, or (e) product, accessories or consumables sold "AS IS" without warranty of any kind by including refurbished Philips product sold "AS IS" by some retailers.

This Limited Warranty does not cover:

- Shipping charges to return defective product.
- Labor charges for installation or setup of the product, adjustment of customer controls on the product, and installation or repair of antenna/signal source systems outside of the product.
- Product repair and/or part replacement because of improper installation or maintenance, connections to improper voltage supply, power line surge, lightning damage, retained images or screen markings resulting from viewing fixed stationary content for extended periods, product cosmetic appearance items due to normal wear and tear, unauthorized repair or other cause not within the control of the company.
- Damage or claims for products not being available for use, or for lost data or lost software.
- Damage from mishandled shipments or transit accidents when returning product.
- A product that requires modification or adaptation to enable it to operate in any country other than the country for which it was designed, manufactured, approved and/or authorized, or repair of products damaged by these modifications.
- A product used for commercial or institutional purposes (including but not limited to rental purposes).
- Product lost in shipment and no signature verification receipt can be provided.
- Failure to operate per Owner's Manual.

TO OBTAIN ASSISTANCE IN THE U.S.A., CANADA, PUERTO RICO, OR U.S. VIRGIN ISLANDS...

Contact Customer Care Center at:
1-866-309-0866

REPAIR OR REPLACEMENT AS PROVIDED UNDER THIS WARRANTY IS THE EXCLUSIVE REMEDY FOR THE CONSUMER. PHILIPS SHALL NOT BE LIABLE FOR ANY INCIDENTAL OR CONSEQUENTIAL DAMAGES FOR BREACH OF ANY EXPRESS OR IMPLIED WARRANTY ON THIS PRODUCT. EXCEPT TO THE EXTENT PROHIBITED BY APPLICABLE LAW, ANY IMPLIED WARRANTY OF MERCHANTABILITY OR FITNESS FOR A PARTICULAR PURPOSE ON THIS PRODUCT IS LIMITED IN DURATION TO THE DURATION OF THIS WARRANTY.

Some states do not allow the exclusions or limitation of incidental or consequential damages, or allow limitations on how long an implied warranty lasts, so the above limitations or exclusions may not apply to you.

This warranty gives you specific legal rights. You may have other rights which vary from state/province to state/province.

P&F USA, Inc.
PO Box 430 Daleville, IN 47334-0430

Introduction

Connections

Basic Setup

Playback

Function Setup

Others

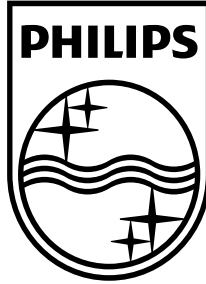

P&F USA, Inc.
PO Box 430 Daleville, IN 47334-0430

P&F Mexicana, S.A. de C.V.
Av. La Palma No. 6, Col. San Fernando La Herradura,
Huixquilucan Edo. de México C.P. 52787

Meet Philips at the Internet
<http://www.philips.com/welcome>

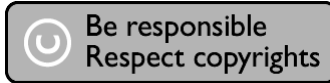

	ENERGIA
BDP7520	120 V ~ 60 Hz 17 W

Comercializado por : P&F Mexicana, S.A. DE C.V.
IMPORTADOR: Sojitz Mexicana, S.A. de C.V.
Av. Paseo de las Palmas no. 239-302
Col. Lomas de Chapultepec, c.p. 11000
México, D.F. 52 (55) 5202 - 7222
EXPORTADOR : FUNAI ELECTRIC CO. L.T.D.
País de Origen : CHINA

GARANTIA INCLUIDA EN EL INSTRUCTIVO DE USO



LEA CUIDADOSAMENTE ESTE INSTRUCTIVO
ANTES DE USAR SU APARATO.



Printed in China
JpnYN-1043/F7-3
1VMN30256A★★★★
E5VK6UD

