

# ***Nikon***

DIGITAL CAMERA

# **1 J1**

## **Reference Manual**

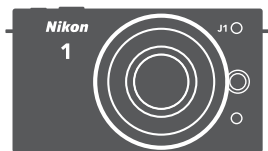

**En**

Thank you for your purchase of a Nikon digital camera. To get the most from your camera, please be sure to read all instructions thoroughly and keep them where they will be read by all who use the product.

### Camera Settings

The explanations in this manual assume that default settings are used.

### Symbols and Conventions

To make it easier to find the information you need, the following symbols and conventions are used:



This icon marks cautions; information that should be read before use to prevent damage to the camera.



This icon marks notes; information that should be read before using the camera.



This icon marks references to other pages in this manual.





























### Digitutor

“Digitutor”, a series of “watch and learn” manuals in movie form, is available from the following website:

[http://www.nikondigitutor.com/index\\_eng.html](http://www.nikondigitutor.com/index_eng.html)

### For Your Safety

Before using the camera for the first time, read the safety instructions in “For Your Safety” (📖 x–xii).

<b>Getting the Most from Your Camera</b>	 ii
<b>Table of Contents</b>	 iv
 <b>Introduction</b>	 1
 <b>Still Image Mode</b>	 21
 <b>Smart Photo Selector Mode</b>	 31
 <b>Movie Mode</b>	 37
 <b>Motion Snapshot Mode</b>	 45
 <b>Available Settings</b>	 49
 <b>More on Photography</b>	 53
 <b>More on Playback</b>	 63
 <b>Connections</b>	 75
 <b>The Playback Menu</b>	 93
 <b>The Shooting Menu</b>	 103
 <b>The Setup Menu</b>	 147
 <b>Technical Notes</b>	 157

## Getting the Most from Your Camera

**Take pictures or movies** in any of four modes.

Choose ① **Motion Snapshot mode** (📖 45) to record both photographs and brief movie vignettes,

② **Smart Photo Selector mode** (📖 31) to capture fleeting changes of expression and other hard-to-time shots,

③ **still image mode** (📖 21) for most photographs, or

④ **movie mode** (📖 37) to record high-definition or slow-motion movies.

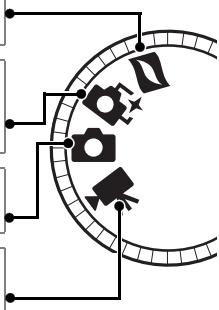

**Combine** photos, movies, and music.

① **Install** the supplied software (📖 75), ② **copy** photos and movies to your computer (📖 79), and ③ use Short Movie Creator to **create** short movies (📖 82).



## **View** short movies in high definition.

① **Transfer** short movies to the camera (📖 83) and use an HDMI cable to ② **connect the camera to an HDTV** (📖 84).



## **Accessories**

Expand your photographic horizons with a wide variety of interchangeable lenses and other accessories (📖 157).



Lenses



Remote controls

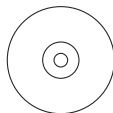

Software for  
Nikon digital  
cameras  
(available on  
CD)

## Table of Contents

Getting the Most from Your Camera .....	ii
Accessories .....	iii
Table of Contents .....	iv
For Your Safety.....	x
Notices .....	xiii
<b>Introduction .....</b>	<b>1</b>
Package Contents.....	1
<b>Parts of the Camera.....</b>	<b>2</b>
The Camera Body .....	2
The Monitor .....	4
The DISP (Display) Button .....	5
The Mode Dial .....	6
The Multi Selector .....	7
The <b>F</b> (Feature) Button .....	8
The MENU Button .....	9
First Steps.....	11
<b>Still Image Mode .....</b>	<b>21</b>
Taking Photos in Still Image Mode .....	21
Viewing Photographs .....	28
Deleting Pictures .....	29
<b>Smart Photo Selector Mode .....</b>	<b>31</b>
Taking Photos in Smart Photo Selector Mode .....	31
Viewing Photographs .....	34
Choosing the Best Shot.....	34
Deleting Pictures .....	35

<b>Movie Mode .....</b>	<b>37</b>
HD Movies.....	37
Slow Motion .....	40
Viewing Movies .....	42
Deleting Movies .....	43
<b>Motion Snapshot Mode.....</b>	<b>45</b>
Shooting in Motion Snapshot Mode .....	45
Viewing Motion Snapshots .....	48
Deleting Motion Snapshots .....	48
<b>Available Settings.....</b>	<b>49</b>
<b>More on Photography .....</b>	<b>53</b>
Self-Timer and Remote Control Modes.....	53
Exposure Compensation .....	56
The Built-in Flash.....	58
Choosing a Flash Mode .....	59
<b>More on Playback .....</b>	<b>63</b>
Photo Information .....	63
Thumbnail Playback.....	66
Calendar Playback .....	67
Playback Zoom .....	68
Deleting Pictures .....	69
Deleting the Current Picture .....	69
The Playback Menu.....	69
Rating Pictures.....	70
Slide Shows .....	71

**Connections ..... 75**

Installing the Supplied Software .....	75
System Requirements.....	77
<b>Viewing and Editing Pictures on a Computer .....</b>	<b>79</b>
Transferring Pictures .....	79
Viewing Pictures .....	80
Creating Short Movies .....	82
<b>Viewing Pictures on TV .....</b>	<b>84</b>
High-Definition Devices.....	84
<b>Printing Photographs .....</b>	<b>86</b>
Connecting the Printer.....	86
Printing Pictures One at a Time.....	87
Printing Multiple Pictures.....	88
Creating a DPOF Print Order: Print Set .....	92

**The Playback Menu ..... 93**

Selecting Multiple Images.....	95
<b>Rotate Tall .....</b>	<b>96</b>
<b>Protect .....</b>	<b>96</b>
<b>Rating.....</b>	<b>96</b>
<b>D-Lighting .....</b>	<b>97</b>
<b>Resize .....</b>	<b>98</b>
<b>Crop.....</b>	<b>99</b>
<b>Edit Movie .....</b>	<b>100</b>

**The Shooting Menu ..... 103**

<b>Reset Shooting Options .....</b>	<b>105</b>
<b>Exposure Mode .....</b>	<b>106</b>
P Programmed Auto .....	108
S Shutter-Priority Auto .....	109
A Aperture-Priority Auto.....	110
M Manual.....	111



<b>Image Quality</b> .....	114
<b>Image Size</b> .....	114
<b>Frame Rate</b> .....	116
<b>Movie Settings</b> .....	116
<b>Metering</b> .....	117
Autoexposure Lock.....	118
<b>White Balance</b> .....	119
Fine-Tuning White Balance .....	120
Preset Manual .....	121
<b>ISO Sensitivity</b> .....	124
<b>Picture Control</b> .....	125
Modifying Picture Controls .....	125
<b>Custom Picture Control</b> .....	129
Edit/Save .....	129
Load from/Save to Card .....	130
<b>Color Space</b> .....	131
<b>Active D-Lighting</b> .....	132
<b>Long Exposure NR</b> .....	133
<b>High ISO Noise Reduction</b> .....	133
<b>Fade in/Fade Out</b> .....	133
<b>Movie Sound Options</b> .....	134
<b>Interval Timer Shooting</b> .....	135
<b>Vibration Reduction</b> .....	136
<b>Focus Mode</b> .....	137
Manual Focus .....	140
<b>AF-Area Mode</b> .....	142
Focus Lock.....	143
<b>Face-Priority AF</b> .....	145
<b>Built-in AF Assist</b> .....	145
<b>Flash Compensation</b> .....	146

<b>The Setup Menu .....</b>	<b>147</b>
Reset Setup Options .....	149
Format Memory Card.....	149
Slot Empty Release Lock .....	149
Welcome Screen .....	150
Monitor Brightness .....	150
Grid Display .....	150
Sound Settings.....	151
Auto Power Off.....	151
Remote on Duration .....	152
Assign AE/AF-L Button .....	152
Shutter Button AE Lock .....	152
Flicker Reduction.....	153
Reset File Numbering .....	153
Time Zone and Date.....	154
Language .....	154
Auto Image Rotation.....	155
Firmware Version .....	155

<b>Technical Notes</b> .....	<b>157</b>
<b>Optional Accessories</b> .....	<b>157</b>
Approved Memory Cards.....	160
Attaching a Power Connector and AC Adapter .....	161
<b>Storage and Cleaning</b> .....	<b>163</b>
Storage .....	163
Cleaning .....	163
<b>Caring for the Camera and Battery: Cautions</b> .....	<b>164</b>
<b>Defaults</b> .....	<b>168</b>
<b>Memory Card Capacity</b> .....	<b>169</b>
<b>Troubleshooting</b> .....	<b>171</b>
Display .....	171
Shooting (All Exposure Modes) .....	172
Shooting (P, S, A, and M Modes) .....	173
Movies.....	174
Playback .....	174
Miscellaneous .....	175
<b>Error Messages</b> .....	<b>176</b>
<b>Specifications</b> .....	<b>180</b>
Nikon 1 J1 Digital Camera .....	180
Battery Life .....	190
<b>Index</b> .....	<b>191</b>

## For Your Safety

To prevent damage to your Nikon product or injury to yourself or to others, read the following safety precautions in their entirety before using this equipment. Keep these safety instructions where all those who use the product will read them.

The consequences that could result from failure to observe the precautions listed in this section are indicated by the following symbol:



This icon marks warnings. To prevent possible injury, read all warnings before using this Nikon product.

### ■ WARNINGS

- ⚠ **Keep the sun out of the frame.** Keep the sun well out of the frame when shooting backlit subjects. Sunlight focused into the camera when the sun is in or close to the frame could cause a fire.
- ⚠ **Do not disassemble.** Touching the product's internal parts could result in injury. In the event of malfunction, the product should be repaired only by a qualified technician. Should the product break open as the result of a fall or other accident, remove the battery and/or AC adapter and then take the product to a Nikon-authorized service center for inspection.
- ⚠ **Turn off immediately in the event of malfunction.** Should you notice smoke or an unusual smell coming from the equipment or AC adapter (available separately), unplug the AC adapter and remove the battery immediately, taking care to avoid burns. Continued operation could result in injury. After removing the battery, take the equipment to a Nikon-authorized service center for inspection.
- ⚠ **Keep out of reach of children.** Failure to observe this precaution could result in injury. In addition, note that small parts constitute a choking hazard. Should a child swallow any part of this equipment, consult a physician immediately.
- ⚠ **Do not use in the presence of flammable gas.** Do not use electronic equipment in the presence of flammable gas, as this could result in explosion or fire.
- ⚠ **Do not place the strap around the neck of an infant or child.** Failure to observe this precaution could result in strangulation.

**⚠ Do not remain in contact with the camera or charger for extended periods while the devices are on or in use.** Parts of the device become hot. Leaving the device in direct contact with the skin for extended periods may result in low-temperature burns.

**⚠ Do not aim the flash at the operator of a motor vehicle.** Failure to observe this precaution could result in accidents.

**⚠ Observe caution when using a flash.**

- Using the camera with the flash in close contact with the skin or other objects could cause burns.
- Using a flash close to the subject's eyes could cause temporary visual impairment. Particular care should be observed when photographing infants, when the flash should be no less than one meter (39 in.) from the subject.

**⚠ Avoid contact with liquid crystal.** Should the displays break, care should be taken to avoid injury due to broken glass and to prevent the liquid crystal from the displays touching the skin or entering the eyes or mouth.

**⚠ Observe proper precautions when handling batteries.** Batteries may leak or explode if improperly handled. Observe the following precautions when handling batteries for use in this product:

- Use only batteries approved for use in this equipment.
- Do not short or disassemble the battery.
- Be sure the product is off before replacing the battery. If you are using an AC adapter, be sure it is unplugged.

- Do not attempt to insert the battery upside down or backwards.
- Do not expose the battery to flame or to excessive heat.
- Do not immerse in or expose to water.
- Replace the terminal cover when transporting the battery. Do not transport or store the battery with metal objects such as necklaces or hairpins.
- Batteries are prone to leakage when fully discharged. To avoid damage to the product, be sure to remove the battery when no charge remains.
- When the battery is not in use, attach the terminal cover and store in a cool, dry place.
- The battery may be hot immediately after use or when the product has been used on battery power for an extended period. Before removing the battery turn the camera off and allow the battery to cool.
- Discontinue use immediately should you notice any changes in the battery, such as discoloration or deformation.

**⚠ Do not remain in contact with the battery for extended periods during charging.** Parts of the device become hot. Leaving the device in direct contact with the skin for extended periods may result in low-temperature burns.

**⚠ Observe proper precautions when handling the charger:**

- Keep dry. Failure to observe this precaution could result in fire or electric shock.
- Do not short the charger terminals. Failure to observe this precaution could result in overheating and damage to the charger.
- Dust on or near the metal parts of the plug should be removed with a dry cloth. Continued use could result in fire.
- Do not go near the charger during thunderstorms. Failure to observe this precaution could result in electric shock.
- Do not handle the plug or charger with wet hands. Failure to observe this precaution could result in electric shock.
- Do not use with travel converters or adapters designed to convert from one voltage to another or with DC-to-AC inverters. Failure to observe this precaution could damage the product or cause overheating or fire.

**⚠ Use appropriate cables.** When connecting cables to the input and output jacks, use only the cables provided or sold by Nikon for the purpose to maintain compliance with product regulations.

**⚠ CD-ROMs:** CD-ROMs containing software or manuals should not be played back on audio CD equipment. Playing CD-ROMs on an audio CD player could cause hearing loss or damage the equipment.

## Notices

- No part of the manuals included with this product may be reproduced, transmitted, transcribed, stored in a retrieval system, or translated into any language in any form, by any means, without Nikon's prior written permission.
- Nikon reserves the right to change the specifications of the hardware and software described in these manuals at any time and without prior notice.
- Nikon will not be held liable for any damages resulting from the use of this product.
- While every effort has been made to ensure that the information in these manuals is accurate and complete, we would appreciate it were you to bring any errors or omissions to the attention of the Nikon representative in your area (address provided separately).

### **Notice for Customers in Canada**

#### **CAUTION**

This Class B digital apparatus complies with Canadian ICES-003.

#### **ATTENTION**

Cet appareil numérique de la classe B est conforme à la norme NMB-003 du Canada.

### **Notice for Customers in Europe**

**CAUTION: RISK OF EXPLOSION IF BATTERY IS REPLACED BY AN INCORRECT TYPE. DISPOSE OF USED BATTERIES ACCORDING TO THE INSTRUCTIONS.**

This symbol indicates that this product is to be collected separately.



The following apply only to users in European countries:

- This product is designated for separate collection at an appropriate collection point. Do not dispose of as household waste.
- For more information, contact the retailer or the local authorities in charge of waste management.

This symbol on the battery indicates that the battery is to be collected separately.



The following apply only to users in European countries:

- All batteries, whether marked with this symbol or not, are designated for separate collection at an appropriate collection point. Do not dispose of as household waste.
- For more information, contact the retailer or the local authorities in charge of waste management.

## Notice for Customers in the U.S.A.

### The Battery Charger

# IMPORTANT SAFETY INSTRUCTIONS—SAVE THESE INSTRUCTIONS

## DANGER—TO REDUCE THE RISK OF FIRE OR ELECTRIC SHOCK, CAREFULLY FOLLOW THESE INSTRUCTIONS

For connection to a supply not in the U.S.A., use an attachment plug adapter of the proper configuration for the power outlet if needed. This power unit is intended to be correctly oriented in a vertical or floor mount position.

### Federal Communications Commission (FCC) Radio Frequency Interference Statement

This equipment has been tested and found to comply with the limits for a Class B digital device, pursuant to Part 15 of the FCC rules. These limits are designed to provide reasonable protection against harmful interference in a residential installation. This equipment generates, uses, and can radiate radio frequency energy and, if not installed and used in accordance with the instructions, may cause harmful interference to radio communications. However, there is no guarantee that interference will not occur in a particular installation. If this equipment does cause harmful interference to radio or television reception, which can be determined by turning the equipment off and on, the user is encouraged to try to correct the interference by one or more of the following measures:

- Reorient or relocate the receiving antenna.
- Increase the separation between the equipment and receiver.
- Connect the equipment into an outlet on a circuit different from that to which the receiver is connected.
- Consult the dealer or an experienced radio/television technician for help.



**Nikon**

1 J1

#### CAUTIONS

##### *Modifications*

The FCC requires the user be notified that any changes or modifications made to this device that are not expressly approved by Nikon Corporation may void the user's authority to operate the equipment.

##### *Interface Cables*

Use the interface cables sold or provided by Nikon for your equipment. Using other interface cables may exceed the limits of Class B Part 15 of the FCC rules.

### Notice for Customers in the State of California

**WARNING:** Handling the cord on this product may expose you to lead, a chemical known to the State of California to cause birth defects or other reproductive harm. *Wash hands after handling.*

Nikon Inc., 1300 Walt Whitman Road, Melville, New York 11747-3064, U.S.A.  
Tel.: 631-547-4200



## **Notice Concerning Prohibition of Copying or Reproduction**

Note that simply being in possession of material that has been digitally copied or reproduced by means of a scanner, digital camera, or other device may be punishable by law.

### **• Items prohibited by law from being copied or reproduced**

Do not copy or reproduce paper money, coins, securities, government bonds, or local government bonds, even if such copies or reproductions are stamped "Sample."

The copying or reproduction of paper money, coins, or securities which are circulated in a foreign country is prohibited.

Unless the prior permission of the government has been obtained, the copying or reproduction of unused postage stamps or post cards issued by the government is prohibited.

The copying or reproduction of stamps issued by the government and of certified documents stipulated by law is prohibited.

### **• Cautions on certain copies and reproductions**

The government has issued cautions on copies or reproductions of securities issued by private companies (shares, bills, checks, gift certificates, etc.), commuter passes, or coupon tickets, except when a minimum of necessary copies are to be provided for business use by a company. Also, do not copy or reproduce passports issued by the government, licenses issued by public agencies and private groups, ID cards, and tickets, such as passes and meal coupons.

### **• Comply with copyright notices**

The copying or reproduction of copyrighted creative works such as books, music, paintings, woodcuts, prints, maps, drawings, movies, and photographs is governed by national and international copyright laws. Do not use this product for the purpose of making illegal copies or to infringe copyright laws.

## **Disposing of Data Storage Devices**

Please note that deleting images or formatting memory cards or other data storage devices does not completely erase the original image data. Deleted files can sometimes be recovered from discarded storage devices using commercially available software, potentially resulting in the malicious use of personal image data. Ensuring the privacy of such data is the user's responsibility.

Before discarding a data storage device or transferring ownership to another person, erase all data using commercial deletion software, or format the device and then completely refill it with images containing no private information (for example, pictures of empty sky). Care should be taken to avoid injury when physically destroying data storage devices.

## **AVC Patent Portfolio License**

THIS PRODUCT IS LICENSED UNDER THE AVC PATENT PORTFOLIO LICENSE FOR THE PERSONAL AND NON-COMMERCIAL USE OF A CONSUMER TO (i) ENCODE VIDEO IN COMPLIANCE WITH THE AVC STANDARD (“AVC VIDEO”) AND/OR (ii) DECODE AVC VIDEO THAT WAS ENCODED BY A CONSUMER ENGAGED IN A PERSONAL AND NON-COMMERCIAL ACTIVITY AND/OR WAS OBTAINED FROM A VIDEO PROVIDER LICENSED TO PROVIDE AVC VIDEO. NO LICENSE IS GRANTED OR SHALL BE IMPLIED FOR ANY OTHER USE. ADDITIONAL INFORMATION MAY BE OBTAINED FROM MPEG LA, L.L.C. SEE <http://www.mpegla.com>

## **Temperature Warnings**

The camera may become warm to the touch during use; this is normal and does not indicate a malfunction. At high ambient temperatures, after extended periods of continuous use, or after several photographs have been taken in quick succession, a temperature warning may be displayed, following which the camera will turn off automatically to minimize damage to its internal circuits. Wait for the camera to cool before resuming use.

## **Use Only Nikon Brand Electronic Accessories**

Nikon cameras are designed to the highest standards and include complex electronic circuitry. Only Nikon brand electronic accessories (including chargers, batteries, AC adapters, and flash accessories) certified by Nikon specifically for use with this Nikon digital camera are engineered and proven to operate within the operational and safety requirements of this electronic circuitry.

The use of non-Nikon electronic accessories could damage the camera and may void your Nikon warranty. The use of third-party rechargeable Li-ion batteries not bearing the Nikon holographic seal shown at right could interfere with normal operation of the camera or result in the batteries overheating, igniting, rupturing, or leaking.

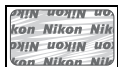

For more information about Nikon brand accessories, contact a local authorized Nikon dealer.

### **Use Only Nikon Brand Accessories**

Only Nikon brand accessories certified by Nikon specifically for use with your Nikon digital camera are engineered and proven to operate within its operational and safety requirements. THE USE OF NON-NIKON ACCESSORIES COULD DAMAGE YOUR CAMERA AND MAY VOID YOUR NIKON WARRANTY.

### **Servicing the Camera and Accessories**

The camera is a precision device and requires regular servicing. Nikon recommends that the camera be inspected by the original retailer or a Nikon-authorized service representative once every one to two years, and that it be serviced once every three to five years (note that fees apply to these services). Frequent inspection and servicing are particularly recommended if the camera is used professionally. Any accessories regularly used with the camera, such as lenses, should be included when the camera is inspected or serviced.

### **Before Taking Important Pictures**

Before taking pictures on important occasions (such as at weddings or before taking the camera on a trip), take a test shot to ensure that the camera is functioning normally. Nikon will not be held liable for damages or lost profits that may result from product malfunction.

### **Life-Long Learning**

As part of Nikon's "Life-Long Learning" commitment to ongoing product support and education, continually-updated information is available on-line at the following sites:

- **For users in the U.S.A.:** <http://www.nikonusa.com/>
- **For users in Europe and Africa:** <http://www.europe-nikon.com/support/>
- **For users in Asia, Oceania, and the Middle East:** <http://www.nikon-asia.com/>

Visit these sites to keep up-to-date with the latest product information, tips, answers to frequently-asked questions (FAQs), and general advice on digital imaging and photography. Additional information may be available from the Nikon representative in your area. For contact information, visit <http://imaging.nikon.com/>



# Introduction

## Package Contents

Confirm that the package contains the following items.

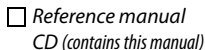
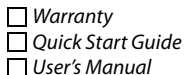
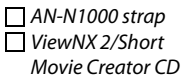
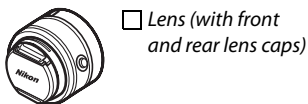
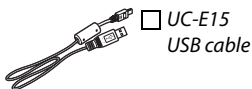
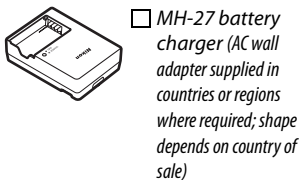
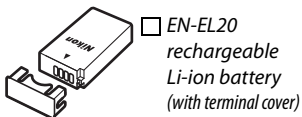
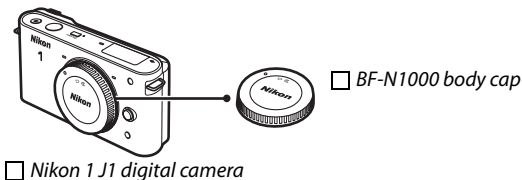

Memory cards are sold separately.

## Parts of the Camera

Take a few moments to familiarize yourself with camera controls and displays. You may find it helpful to bookmark this section and refer to it as you read through the rest of the manual.

### The Camera Body

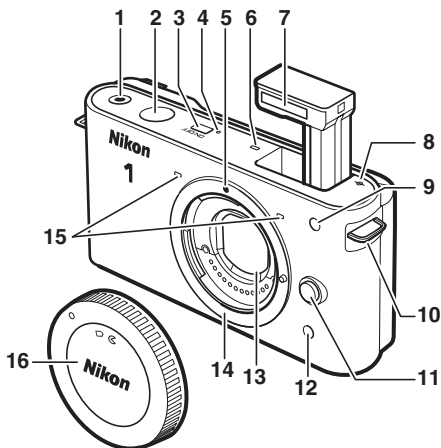

<b>1</b> Movie-record button .....	38	<b>10</b> Eyelet for camera strap .....	11
<b>2</b> Shutter-release button .....	25, 32, 39	<b>11</b> Lens release button .....	16
<b>3</b> Power switch .....	17	<b>12</b> Infrared receiver .....	54, 173
<b>4</b> Power lamp .....	17	<b>13</b> Dust shield .....	163
<b>5</b> Mounting mark .....	16	<b>14</b> Lens mount .....	16, 141
<b>6</b> Speaker .....	42	<b>15</b> Microphone .....	38, 134
<b>7</b> Built-in flash .....	58	<b>16</b> Body cap .....	159
<b>8</b> Focal plane mark (☉) .....	141		
<b>9</b> AF-assist illuminator .....	138, 145		
Self-timer lamp .....	54		
Red-eye reduction lamp .....	58		

## The Camera Body (Continued)

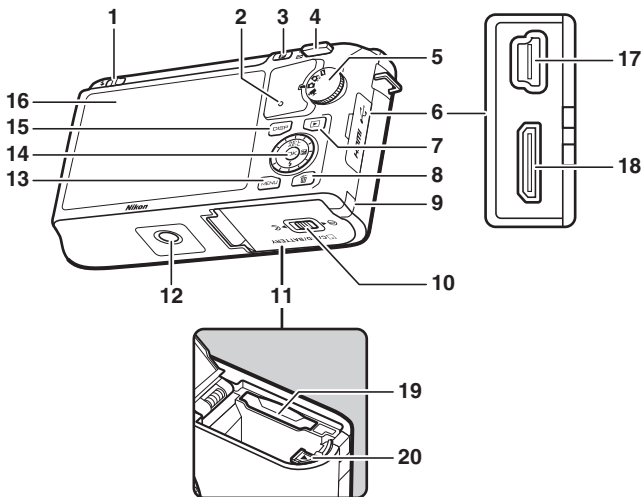

- |  |            |   |               |
|--|------------|---|---------------|
| <b>1</b> Flash pop-up control .....                                  | 58         | <b>12</b> Tripod socket .....           |               |
| <b>2</b> Memory card access lamp .....                               | 15, 24     | <b>13</b> MENU (menu) button .....      | 9             |
| <b>3</b> (feature) button .....                                      | 8          | <b>14</b> Multi selector .....          | 7             |
| <b>4</b> (playback zoom/<br>thumbnail) control .....                 | 28, 141    | <b>15</b> (OK) button .....             | 7             |
| <b>5</b> Mode dial .....   | 6          | <b>16</b> (AE-L/AF-L) .....             | 118, 143, 152 |
| <b>6</b> Connector cover .....                                       |            | <b>17</b> (exposure compensation) ..... | 56            |
| <b>7</b> (playback) button .....                                     | 28, 34, 48 | <b>18</b> (flash mode) .....            | 59            |
| <b>8</b> (delete) button .....                                       | 35, 69     | <b>19</b> (self-timer) .....            | 53            |
| <b>9</b> Power connector cover<br>for optional power connector ..... | 161        | <b>20</b> DISP (display) button .....   | 5             |
| <b>10</b> Battery-chamber/memory card slot<br>cover latch .....      | 13, 15     | <b>16</b> Monitor .....                 | 4, 5          |
| <b>11</b> Battery-chamber/<br>memory card slot cover .....           | 13, 15     | <b>17</b> USB connector .....           | 79            |
|  |            | <b>18</b> HDMI mini-pin connector ..... | 84            |
|  |            | <b>19</b> Memory card slot .....        | 13            |
|  |            | <b>20</b> Battery latch .....           | 13, 15, 161   |

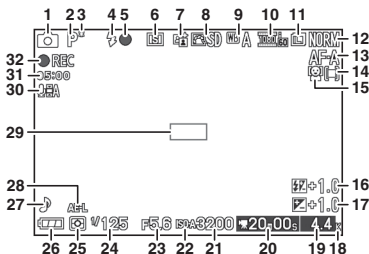

<b>1</b> Shooting mode .....	6	<b>19</b> Number of exposures remaining .....	20
<b>2</b> Exposure mode .....	106	Number of shots remaining before memory buffer fills .....	23, 27
<b>3</b> Flexible program indicator .....	108	White balance recording indicator .....	121
<b>4</b> Flash mode .....	58	Card warning indicator .....	149, 176
<b>5</b> Flash-ready indicator .....	58	<b>20</b> Time available .....	38, 41
<b>6</b> Self-timer/ remote control mode .....	53	<b>21</b> ISO sensitivity * .....	124
Continuous mode * .....	26	<b>22</b> ISO sensitivity indicator * .....	124
<b>7</b> Active D-Lighting * .....	132	Auto ISO sensitivity indicator * .....	124
<b>8</b> Picture Control * .....	125	<b>23</b> Aperture .....	110, 111
<b>9</b> White balance * .....	119	<b>24</b> Shutter speed .....	109, 111
<b>10</b> Movie settings (HD movies) * .....	116	<b>25</b> Metering .....	117
Frame rate (slow motion movies) * .....	116	<b>26</b> Battery indicator * .....	20
<b>11</b> Image size * .....	114	<b>27</b> Sound settings * .....	151
<b>12</b> Image quality * .....	114	<b>28</b> Autoexposure (AE) lock indicator .....	118, 143
<b>13</b> Focus mode * .....	137	<b>29</b> Focus area .....	23, 142
<b>14</b> AF-area mode * .....	142	<b>30</b> Microphone sensitivity * .....	38, 134
<b>15</b> Face-priority AF * .....	23, 145	<b>31</b> Time elapsed .....	38, 41
<b>16</b> Flash compensation .....	146	<b>32</b> Recording indicator .....	38, 41
<b>17</b> Exposure compensation .....	56		
<b>18</b> "K" (appears when memory remains for over 1,000 exposures) .....	20		

\* Available only in detailed display (□ 5).



## The DISP (Display) Button

Press DISP to cycle through shooting ( 4) and playback ( 63) indicators as shown below.

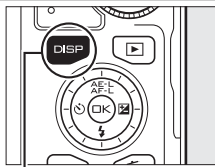

DISP button

### Shooting

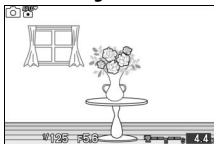

Simplified display

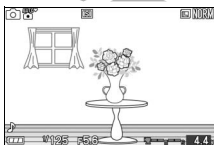

Detailed display

### Playback

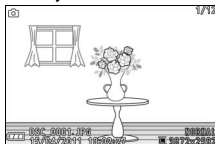

Simple photo info

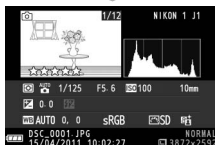

Detailed photo info

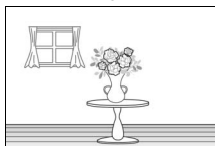
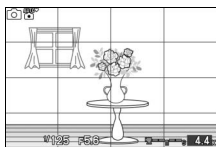

Image only

### The Framing Grid

A framing grid can be displayed by selecting **On** for **Grid display** in the setup menu ( 150).



## The Mode Dial

The camera offers a choice of the following shooting modes:

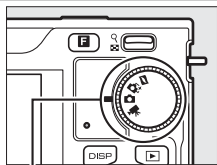

Mode dial



**Motion Snapshot mode** (☞ 45): Each time the shutter is released, the camera records a still image and about a second of movie footage. When the resulting “Motion Snapshot” is viewed on the camera, the movie will play back in slow motion over approximately 2.5 s, followed by the still image.



**Smart Photo Selector mode** (☞ 31): Each time the shutter is released, the camera automatically selects the best shot and four best shot candidates based on composition and motion.

**Still image mode** (☞ 21): For photographs. By default, the camera automatically adjusts camera settings to suit the subject (automatic scene selection).

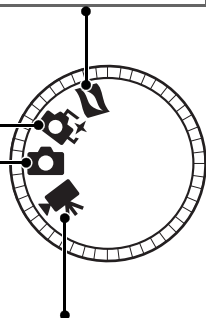
**Movie mode** (☞ 37): Record HD or slow-motion movies.



## The Multi Selector

The multi selector and  button are used to adjust settings and navigate the camera menus ( 9).

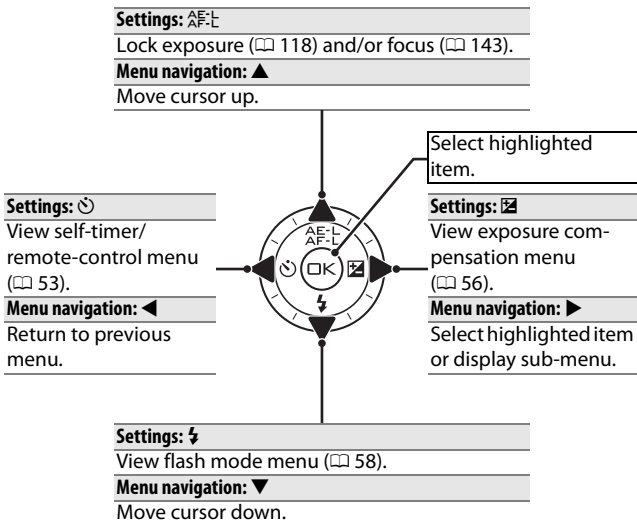



**Note:** You can also highlight items by rotating the multi selector.

### The Multi Selector

In this manual, the ▲, ▶, ▼, and ◀ symbols are used to represent up, right, down, and left on the multi selector. Items can be highlighted by rotating the multi selector as shown at right.





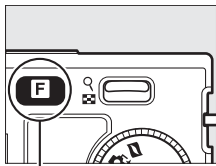

## The **F** (Feature) Button

The **F** button gives access to the following features in still-image, movie, Motion Snapshot, and playback modes. Press **F** and use the multi selector (or  control) and  button to adjust options.



**F** button

- **Continuous (still-image mode;  26):** Choose from **Single frame**, **Continuous**, or **Electronic (Hi)**.
- **Movie mode (movie recording;  39):** Choose from high-definition (**HD movie**) and slow-motion (**Slow motion**) recording.
- **Theme (Motion Snapshot mode;  47):** Choose from **Beauty**, **Waves**, **Relaxation**, and **Tenderness**.
- **Rating (playback mode;  70):** Rate pictures.

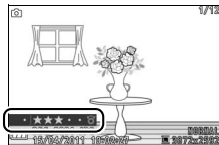

## The MENU Button

Most shooting, playback, and setup options can be accessed from the camera menu. To view the menus, press the MENU button.

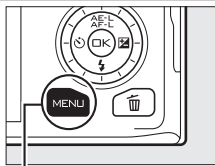

MENU button

### Tabs

Choose from the following menus:

▶ Playback menu (103)

⚙ Setup menu (147)

📷 Shooting menu (103)

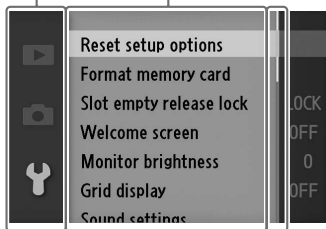

Menu options  
Options in current menu.

Slider shows position in current menu.



## ■ ■ Using the Menus

Use the multi selector to navigate the menus (📖 7).

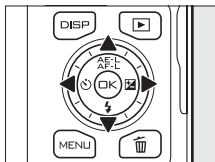

*Multi selector*

**1** Press ▲ or ▼ to select the tab then press ▶ to display menu items.

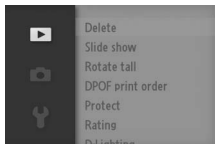

**2** Highlight menu item and press ▶ to display options.

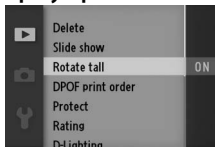

**3** Highlight desired option and press Ⓞ to select.

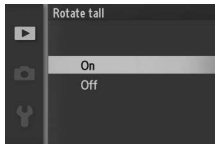

**Note:** The items listed may vary with camera settings. Items displayed in gray are not currently available (📖 49).

To exit the menus and return to shooting mode, press the shutter-release button halfway (📖 25).

## First Steps

### 1 Attach the camera strap.

Attach the strap securely to the two camera eyelets.

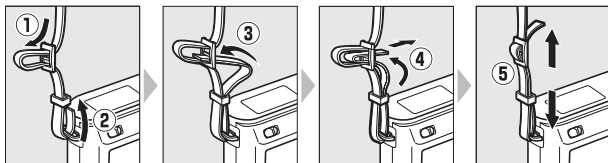

### 2 Charge the battery.

Insert the battery ① and plug the charger in ②. An exhausted battery fully charges in about 2 hours. Unplug the charger and remove the battery when charging is complete.

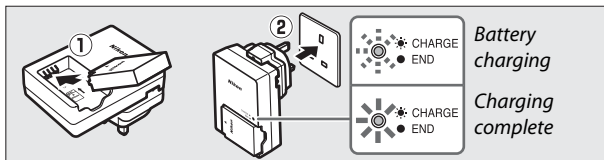

#### The Plug Adapter

Depending on the country or region of purchase, a plug adapter may be supplied with the charger. The shape of the adapter varies with the country or region of purchase. If a plug adapter is supplied, raise the wall plug and connect the plug adapter as shown at right, making sure the plug is fully inserted. Attempting to forcibly remove the plug adapter could damage the product.

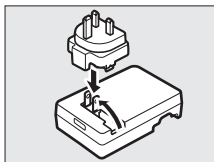



### **✔ The Battery and Charger**

*Read and follow the warnings and cautions on pages x–xii and 164–167 of this manual.* Do not use the battery at ambient temperatures below 0°C/32°F or above 40°C/104°F; failure to observe this precaution could damage the battery or impair its performance. Capacity may be reduced and charging times may increase at battery temperatures from 0°C/32°F to 10°C/50°F and from 45°C/113°F to 60°C/140°F; the battery will not charge if its temperature is below 0°C/32°F or above 60°C/140°F.

Charge the battery at ambient temperatures between 5°C/41°F and 35°C/95°F. If the **CHARGE** lamp flickers during charging, cease use immediately and take battery and charger to your retailer or a Nikon-authorized service representative.

Do not move the charger or touch the battery during charging. Failure to observe this precaution could in very rare instances result in the charger showing that charging is complete when the battery is only partially charged. Remove and reinsert the battery to begin charging again.

Use the charger with compatible batteries only. Unplug when not in use.



### 3 Insert the battery and a memory card.

Check to be sure the battery and card are in the correct orientation. Using the battery to keep the orange battery latch pressed to one side, slide the battery in until it latches, and then slide in the memory card until it clicks into place.

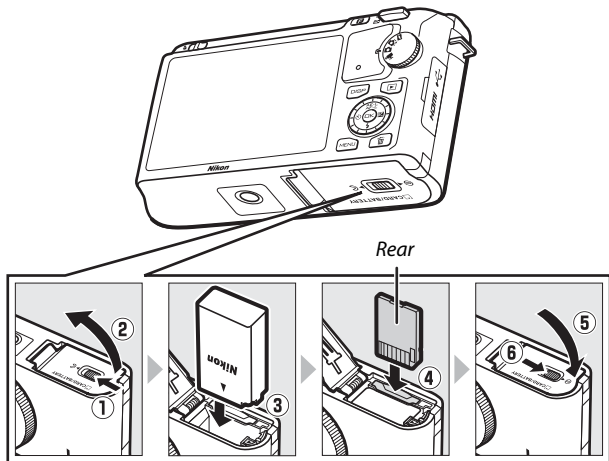

### ✓ Inserting and Removing Batteries and Memory Cards

Always turn the camera off before inserting or removing batteries or memory cards. Note that the battery may be hot after use; observe due caution when removing the battery.

### ✎ Formatting Memory Cards

If this is the first time the memory card will be used in the camera or if the card has been formatted in another device, select **Format memory card** in the setup menu and follow the on-screen instructions to format the card (📖 149). *Note that this permanently deletes any data the card may contain.* Be sure to copy any photographs and other data you wish to keep to a computer before proceeding.

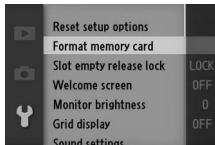

### ✎ The Write Protect Switch

Memory cards are equipped with a write protect switch to prevent accidental loss of data. When this switch is in the “lock” position, the memory card can not be formatted and photos can not be deleted or recorded. To unlock the memory card, slide the switch to the “write” position.

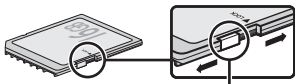

Write-protect switch

### Removing Batteries and Memory Cards

After turning the camera off, confirm that the access lamp (☐ 3) is off and open the battery-chamber/memory card slot cover. To remove the battery, first release it by pressing the orange battery latch in the direction shown by the arrow and then remove the battery by hand.

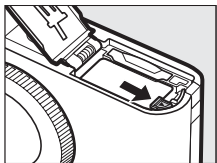

To remove a memory card, first press the card in to eject it (①); the card can then be removed by hand (②).

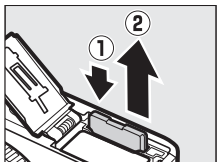

### Memory Cards

- The camera stores pictures on Secure Digital (SD), SDHC, and SDXC memory cards (available separately; ☐ 160).
- Memory cards may be hot after use. Observe due caution when removing memory cards from the camera.
- Do not remove memory cards from the camera, turn the camera off, or remove or disconnect the power source during formatting or while data are being recorded, deleted, or copied to a computer. Failure to observe these precautions could result in loss of data or in damage to the camera or card.
- Do not touch the card terminals with your fingers or metal objects.
- Do not bend, drop, or subject to strong physical shocks.
- Do not apply force to the card casing. Failure to observe this precaution could damage the card.
- Do not expose to water, heat, high levels of humidity, or direct sunlight.



## 4 Attach a lens.

Be careful to prevent dust from entering the camera when the lens or body cap is removed. The lens generally used in this manual for illustrative purposes is a 1 NIKKOR VR 10–30 mm f/3.5–5.6. See page 136 for information on vibration reduction (VR).

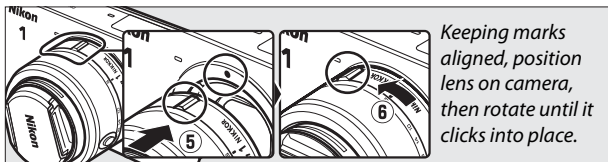
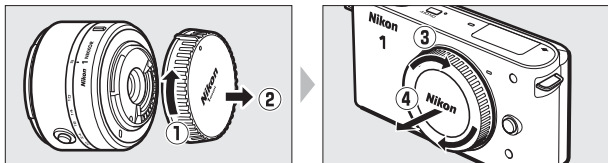

### Lenses with Retractable Lens Barrel Buttons

Lenses with retractable lens barrel buttons can not be used when retracted. To unlock and extend the lens, keep the retractable lens barrel button pressed (1) while rotating the zoom ring (2). The lens can be retracted and the zoom ring locked by pressing the retractable lens barrel button and rotating the ring in the opposite direction. Be careful not to press the retractable lens barrel button while attaching or removing the lens.

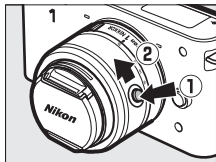

### Detaching the Lens

Be sure the camera is off when removing or exchanging lenses. To remove the lens, press and hold the lens release button (1) while turning the lens clockwise (2). After removing the lens, replace the lens caps and camera body cap.

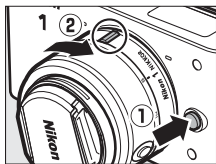

## 5 Turn the camera on.

Press the power switch to turn the camera on. The power lamp will briefly light green and the monitor will turn on.

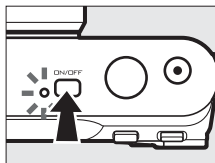

### Turning the Camera Off

To turn the camera off, press the power switch again. The monitor will turn off.

### Auto Power Off

If no operations are performed for about thirty seconds, the displays will turn off and the power lamp start to blink (if desired, the delay before the displays turn off automatically can be changed using the **Auto power off** option in the setup menu; □ 151). The camera can be reactivated by operating the buttons, mode dial, or other camera controls. If no operations are performed for about three minutes after the displays have turned off, the camera will turn off automatically.

### Attaching and Removing Lenses

Turn the camera off before attaching or removing lenses. Note that when the camera is turned off, the sensor protection barrier in the lens will close, protecting the camera image sensor. If the lens has a retractable lens barrel button, retract the lens before removal.

### Lenses with Retractable Lens Barrel Buttons

If you are using a lens with a retractable lens barrel button (□ 16), the camera will turn on automatically when the retractable lens barrel lock is released (locking the lens barrel does not, however, turn the camera off).



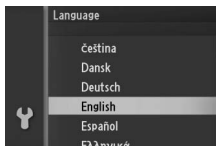

## 6 Choose a language and set the clock.

A language-selection dialog will be displayed the first time the camera is turned on. Use the multi selector and  button (📖 10) to choose a language and set the camera clock. Photos can not be taken until you have set the time and date.

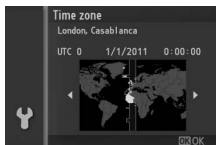

Press ▲ or ▼ to highlight language and press .



Press ◀ or ▶ to highlight time zone and press .

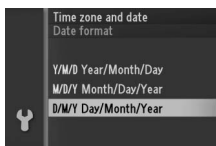

Press ▲ or ▼ to highlight date format and press .

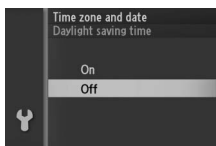

Press ▲ or ▼ to highlight daylight saving time option and press .

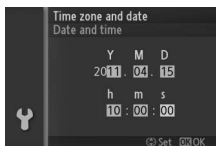

Press ◀ or ▶ to select items and press ▲ or ▼ to change. Press  when finished.

**Note:** Language and clock can be changed at any time using **Language** (📖 154) and **Time zone and date** (📖 154) options in setup menu.

### **The Camera Clock**

The camera clock is less accurate than most watches and household clocks. Check the clock regularly against more accurate time pieces and reset as necessary.

The camera clock is powered by an independent, rechargeable power source, which is charged as necessary when the main battery is installed or the camera is powered by an optional EP-5C power connector and EH-5b AC adapter (☞ 161). Three days of charging will power the clock for about a month. If a message warning that the clock has been reset is displayed when the camera is turned on, the clock battery is exhausted and the clock has been reset. Set the clock to the correct time and date.





## 7 Check the battery level and memory card capacity.

Check the battery level and number of exposures remaining in the monitor.

### Battery level

#### ■ ■ Battery Level

Display	Description
NO ICON	Battery fully charged or partially discharged; level shown by  or  icon in detailed display (□ 5).
	Low battery. Ready fully-charged battery or prepare to charge battery.
Cannot take pictures. Insert fully-charged battery.	Battery exhausted; shutter-release disabled. Insert charged battery.

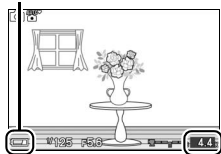

Exposures remaining

#### ■ ■ Number of Exposures Remaining

The monitor shows the number of pictures that can be stored on the memory card at current settings (values over 1,000 are rounded down to the nearest hundred; e.g., values between 1,200 and 1,299 are shown as 1.2 K). If a warning is displayed stating that there is not enough memory for additional images, insert another memory card (□ 13) or delete some photos (□ 69).





# Still Image Mode

Still image mode is the mode generally used for taking photos.

## Available Settings

For information on the options available in still image mode, see page 49.

## Taking Photos in Still Image Mode

### 1 Select still image mode.

Rotate the mode dial to .

Mode dial

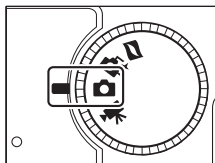





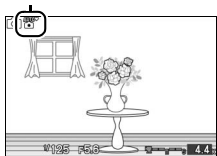

## Automatic Scene Selection (SCN \* Scene auto selector)

At default settings, the camera will automatically analyze the subject and select the appropriate scene. The selected scene is shown in the monitor.

Scene icon



	<b>Portrait:</b> Human portrait subjects.
	<b>Landscape:</b> Landscapes and cityscapes.
	<b>Night portrait:</b> Portrait subjects framed against dark backgrounds.
	<b>Close up:</b> Subjects close to the camera.
	<b>Auto:</b> Subjects suited to  mode or that do not fall into the categories listed above.

## 2 Ready the camera.

Remove the lens cap and hold the camera securely with both hands, being careful not to obstruct the lens, AF-assist illuminator, or microphone. Rotate the camera as shown at lower right when taking pictures in “tall” (portrait) orientation.

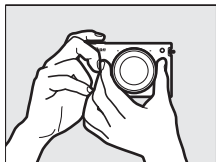

Shutter speeds slow when lighting is poor; use of the built-in flash (☐ 58) or a tripod is recommended.

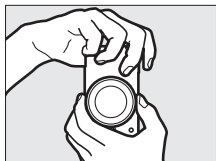

### Using a Zoom Lens

Use the zoom ring to zoom in on the subject so that it fills a larger area of the frame, or zoom out to increase the area visible in the final photograph (select longer focal lengths on the lens focal length scale to zoom in, shorter focal lengths to zoom out; if you are using a lens with a retractable lens barrel button, unlock and extend the lens by pressing the button and rotating the zoom ring as described on page 16).

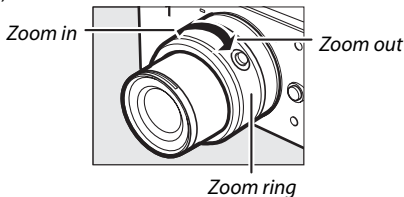

If you are using an optional lens with a power drive zoom switch, select **T** to zoom in and **W** to zoom out. The speed with which the camera zooms in and out varies with how far you slide the switch. The zoom position is shown by the zoom guide in the display.

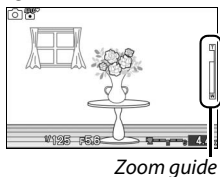

### 3 Frame the photograph.

Position your subject in the center of the frame.

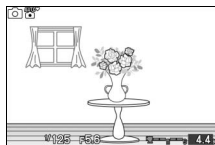

### 4 Focus.

Press the shutter-release button halfway to focus. If the subject is poorly lit, the AF-assist illuminator (📖 2) may light to assist the focus operation.



**If the camera is able to focus**, the selected focus area will be highlighted in green and a beep will sound (a beep may not sound if the subject is moving).

*Focus area*

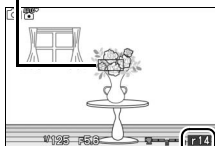

**If the camera is unable to focus**, the focus area will be displayed in red. See page 139.

*Buffer capacity*

While the shutter-release button is pressed halfway, the display will show the number of exposures that can be stored in the memory buffer ("r"; 📖 27).

#### Face-Priority AF

The camera detects and focuses on portrait subjects (face-priority AF). A double yellow border will be displayed if a portrait subject is detected facing the camera (if multiple faces, up to a maximum of five, are detected, the camera will select the closest subject). Press the shutter-release button halfway to focus on the subject in the double yellow border. The border will clear from the display if the camera can no longer detect the subject (because, for example, the subject has looked away).



## 5 Shoot.

Smoothly press the shutter-release button the rest of the way down to release the shutter and record the photograph. The access lamp will light and the photograph will be displayed in the monitor for a few seconds (the photo will automatically clear from the display and the camera will be ready to shoot when the shutter-release button is pressed halfway). *Do not eject the memory card or remove or disconnect the power source until the lamp has gone out and recording is complete.*

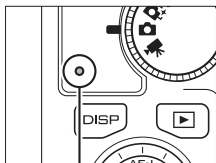

Access lamp

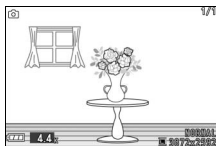

### **The Shutter-Release Button**

The camera has a two-stage shutter-release button. The camera focuses when the shutter-release button is pressed halfway. To take the photograph, press the shutter-release button the rest of the way down.



**Focus:** Press halfway



**Shoot:** Press the rest of the way down

### **Movie Recording**

In still image mode, movies can not be recorded and pressing the movie-record button has no effect.

### **See Also**

See page 151 for information on silencing the beep that sounds when the camera focuses or the shutter is released.



## ■ Choosing a Release Mode

Press **F** button and use the multi selector and **OK** button to choose from the following release modes: **Single frame** (the camera takes one photograph each time the shutter-release button is pressed), **Continuous** (the camera records photos at up to 5 frames per second while the shutter release button is held down), and **Electronic (Hi)** (the camera records photos at high rates while the shutter-release button is held down).

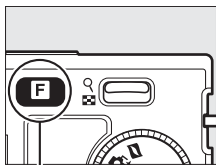

**F** button

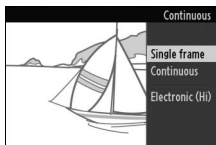

### 🔍 **Electronic (Hi)**

Choose from frame rates of 10 fps, 30 fps, and 60 fps (📖 103). The flash does not fire while **Electronic (Hi)** is in effect. At the default setting of 10 fps, the camera takes pictures at about 10 frames per second (fps) while the shutter-release button is pressed and camera focuses on the subject in the center of the frame; face detection (📖 23) is not available. At frame rates of 30 and 60 fps, face detection is available but focus and exposure are fixed at the values for the first photograph in each series.

### 🔍 **Continuous**

If the flash is used, the camera will take only one photograph each time the shutter-release button is pressed. Lower the flash before taking pictures.

### 🔍 **Shooting in Electronic (Hi) and Continuous Release Modes**

While photographs are being recorded to the memory card, the access lamp will light. Depending on shooting conditions and memory card write speed, recording may take up to about one minute. If the battery is exhausted before all photographs are recorded, the shutter release will be disabled and the remaining images transferred to the memory card.

### **Buffer Size**

The camera is equipped with a memory buffer for temporary storage, allowing shooting to continue while photographs are being saved to the memory card. Up to 100 photographs can be taken in succession; note, however, that the frame rate will drop or shooting will pause when the buffer is full.

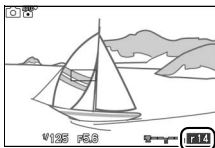

The approximate number of images that can be stored in the memory buffer at current settings is displayed while the shutter-release button is pressed halfway (this number is an approximation only and varies with shooting conditions). The illustration shows the display when space remains in the buffer for about 14 pictures.

### **See Also**

For information on the number of photographs that can be taken in a single burst, see page 169.



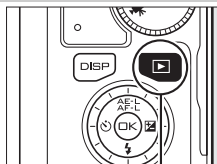

## Viewing Photographs

Press  to display your most recent photograph full frame in the monitor (full-frame playback).







 button



Press  or  or rotate the multi selector to view additional pictures.



To zoom in on the center of the current image, press the  control up ( 68). Press  down to zoom out. To view multiple images, press  down when the picture is displayed full frame ( 66).

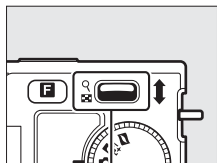

 control

To end playback and return to shooting mode, press the shutter-release button halfway.

### See Also

For information on toggling photo info on or off, see page 63. See page 71 for information on slide shows.



## Deleting Pictures

To delete the current picture, press . Note that once deleted, pictures can not be recovered.

### 1 Display the photograph.

Display the photograph you wish to delete as described on the preceding page.

### 2 Delete the photograph.

Press . A confirmation dialog will be displayed; press again to delete the picture and return to playback, or press to exit without deleting the picture.

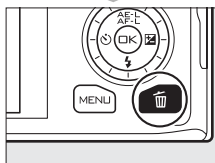
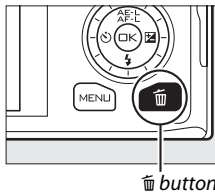

### Deleting Multiple Pictures (69)

The **Delete** option in the playback menu can be used to delete selected pictures, all pictures, pictures taken on selected dates, or pictures previously selected as candidates for deletion.



# Smart Photo Selector Mode

Choose Smart Photo Selector mode for photos that capture a fleeting expression on the face of a portrait subject or other hard-to-time shots such as group photos in party scenes. Each time the shutter is released, the camera automatically selects the best shot and four best shot candidates based on composition and motion.

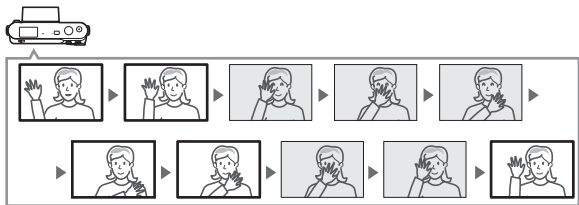

## Available Settings

For information on the options available in Smart Photo Selector mode, see page 49.

## Taking Photos in Smart Photo Selector Mode

### 1 Select Smart Photo Selector mode.

Rotate the mode dial to .

*Mode dial*

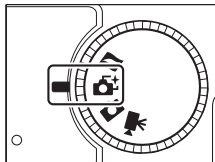

## 2 Frame the photograph.

Holding the camera as shown on page 22, compose the photograph with your subject in the center of the frame.



## 3 Begin buffering photographs.

Press the shutter-release button half-way to focus (📖 23). An icon will be displayed as the camera begins recording images to the memory buffer. The camera continuously adjusts focus to account for changes in the distance to the subject in the AF area brackets while the shutter-release button is pressed halfway.



*AF area brackets*

### Buffering

Buffering begins when the shutter-release button is pressed halfway and ends after about 90 seconds or when the shutter-release button is pressed all the way down.

*Shutter-release  
button pressed  
halfway to focus*

*Shutter-release button  
pressed all the way  
down*

*Shooting ends*



#### 4 Shoot.

Smoothly press the shutter-release button the rest of the way down. The camera will compare shots recorded to the buffer both before and after the shutter-release button was pressed, and select five to copy to the memory card. Note that some time may be required. The best picture is displayed in the monitor when recording is complete.



#### Smart Photo Selector Mode

The camera automatically chooses a scene mode appropriate to the subject (automatic scene selection;  21). Movies can not be recorded, and pressing the movie-record button has no effect. The flash can not be used.





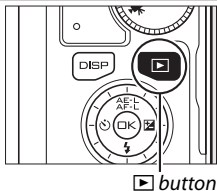

## Viewing Photographs

Press  and use the multi selector to display photographs taken with the Smart Photo Selector (see page 28; pictures taken with the Smart Photo Selector are indicated by a  icon). Of the five photographs recorded by the Smart Photo Selector, only the best shot will be displayed (when you press the multi selector right to view the next picture, the camera will skip over the best shot candidates, with the result that the next picture displayed will not have a file number that immediately follows that of the current picture). To end playback and return to shooting mode, press the shutter-release button halfway.





### Choosing the Best Shot

When a photograph taken with the Smart Photo Selector is displayed, you can choose the best shot by pressing . Press  or  to view the other pictures in the sequence and press  to select the current picture as the best shot. To return to normal playback, press .



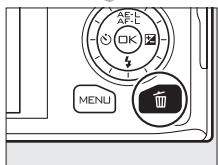
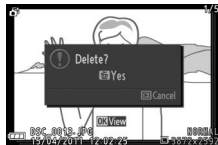
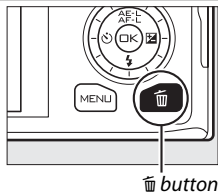

## Deleting Pictures

Pressing  when a picture taken with the Smart Photo Selector is selected displays a confirmation dialog; press  again to delete the best shot and the four best shot candidates, or press  to exit without deleting the pictures. *Note that once deleted, pictures can not be recovered.*



### Deleting Individual Photographs

Pressing the  button in the best shot selection dialog displays the following options; highlight an option using the multi selector and press  to select.

- **This image:** Delete the current photo (note that the picture currently selected as the best shot can not be deleted).
- **All except best shot:** Delete all photos in the sequence except the one currently selected as the best shot.

A confirmation dialog will be displayed; to delete the selected image or images, highlight **Yes** and press .







# Movie Mode

Choose movie mode to shoot **high-definition (HD)** or **slow-motion** (☐ 40) movies using the movie-record button.

## ✓ The Icon

A  icon indicates that movies can not be recorded.

## ✓ Available Settings

For information on the options available in movie mode, see page 49.

## HD Movies

Record movies with sound at an aspect ratio of 16 : 9.

### 1 Select movie mode.

Rotate the mode dial to . An HD movie crop with an aspect ratio of 16 : 9 will appear in the display.

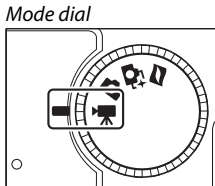

### 2 Frame the opening shot.

Holding the camera as shown on page 22, frame the opening shot with your subject in the center of the display.

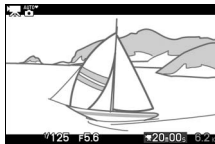

## ✓ Exposure Mode

By default, the camera automatically chooses a scene mode appropriate to the subject (automatic scene selection; ☐ 21).

## ✓ See Also

See page 133 for information on adding fade in/fade out effects. Frame size and frame rate options are described on page 116.

### 3 Start recording.

Press the movie-record button to begin recording. A recording indicator, the time elapsed, and the time available are displayed while recording is in progress.

#### **Audio Recording**

Be careful not to cover the microphone and note that the built-in microphone may record sounds made by the camera or lens. By default, the camera focuses continuously; to avoid recording focus noise, select a focus mode of **AF-S** (□ 137). The **Movie sound options** item in the shooting menu offers sensitivity and wind noise options for the built-in microphone (□ 134).

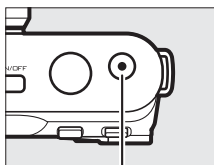

*Movie-record button*

*Recording indicator/  
Time elapsed*



*Time available*



### 4 End recording.

Press the movie-record button again to end recording. Recording will end automatically when the maximum length is reached (□ 116), the memory card is full, another mode is selected, the lens is removed, or the camera becomes hot (□ xvi).

#### **Maximum Length**

HD movies can be up to 4 GB in size and 20 minutes in length (for more information, see page 116); note that depending on memory card write speed, shooting may end before this length is reached (□ 160).

#### **Exposure Lock**

In exposure modes other than  **Scene auto selector**, exposure will lock while the  (multi selector up) button is pressed (□ 118).

## ■ Taking Photographs During HD Movie Recording

Press the shutter-release button all the way down to take a photograph without interrupting HD movie recording. Photographs taken during movie recording have an aspect ratio of 16 : 9.



### ■ Taking Photographs During Movie Recording

Up to 15 photographs can be taken with each movie shot. Please note that photographs can not be taken with slow-motion movies.

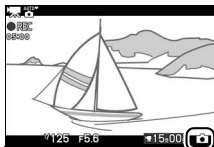

## ■ Choosing the Movie Type

To choose between high definition and slow motion recording, press **F** and use the multi selector and **OK** button to choose from the following options:

- **HD movie:** Record movies in HD.
- **Slow motion:** Record slow-motion movies (□ 40).

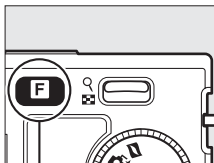

**F** button

### ■ Recording Movies

Flicker, banding, or distortion may be visible in the displays and in the final movie under fluorescent, mercury vapor, or sodium lamps or if the camera is panned horizontally or an object moves at high speed through frame (flicker and banding can be reduced in HD movies by choosing a **Flicker reduction** option that matches the frequency of the local AC power supply; □ 153). Bright light sources may leave after-images when the camera is panned. Jagged edges, color fringing, moiré, and bright spots may also appear. When recording movies, avoid pointing the camera at the sun or other strong light sources. Failure to observe this precaution could result in damage to the camera's internal circuitry.

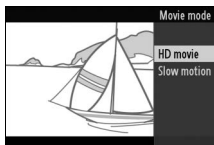

## Slow Motion

Record silent movies with an aspect ratio of 8 : 3. Movies are recorded at 400 fps and play back at 30 fps.

### 1 Select movie mode.

Rotate the mode dial to .

Mode dial

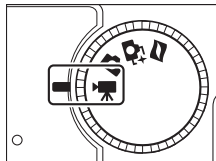

### 2 Select slow-motion mode.

Press the **F** button and use the multi-selector and **OK** button to select **Slow motion**. A slow-motion movie crop with an aspect ratio of 8 : 3 will appear in the display.

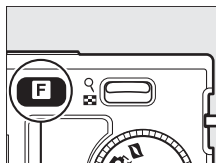

**F** button

### 3 Frame the opening shot.

Holding the camera as shown on page 22, frame the opening shot with your subject in the center of the display.



---

## 4 Start recording.

Press the movie-record button to begin recording. A recording indicator, the time elapsed, and the time available are displayed while recording is in progress. The camera focuses on the subject at the center of the display; face detection (📖 23) is not available.

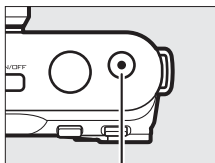

*Movie-record button*

*Recording indicator/  
Time elapsed*

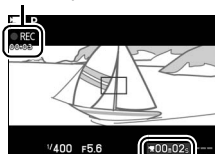

*Time available*

---

## 5 End recording.

Press the movie-record button again to end recording. Recording will end automatically when the maximum length is reached, the memory card is full, another mode is selected, the lens is removed, or the camera becomes hot (📖 xvi).

### **Maximum Length**

Up to 5 seconds or 4 GB of footage can be recorded; note that depending on memory card write speed, shooting may end before this length is reached (📖 160).

### **Exposure Mode**



The default exposure mode for slow-motion movie recording is **P Programmed auto** (📖 108). **SR** **Scene auto selector** is not available in slow-motion movie mode.

### **See Also**

Frame rate options are described on page 116.



## Viewing Movies

Movies are indicated by a  icon in full-frame playback ( 28). Press  to start playback.







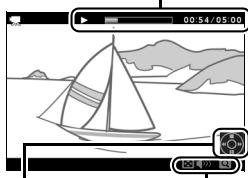





 icon/Length





Movie playback indicator/  
Current position/total length



The following operations can be performed:

To	Use	Description
Pause		Pause playback.
Play		Resume playback when the movie is paused or during rewind/advance.
Advance/ rewind	 / 	Press  to rewind,  to advance. Speed increases with each press, from 2 × to 5 × to 10 × to 15 ×. If playback is paused, the movie rewinds or advances one frame at a time; keep the button pressed for continuous rewind or advance. You can also rotate the multi selector to rewind or advance when playback is paused.
Adjust volume		Press up to increase volume, down to decrease.
Return to full-frame playback	 / 	Press  or  to exit to full-frame playback.
Exit to shooting mode		Press the shutter-release button halfway to exit to shooting mode.

## Deleting Movies

To delete the current movie, press . A confirmation dialog will be displayed; press  again to delete the movie and return to playback, or press  to exit without deleting the movie. *Note that once deleted, movies can not be recovered.*

### See Also

See page 100 for information on trimming unwanted footage from movies.

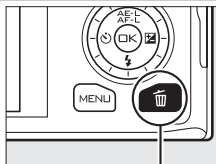

 button

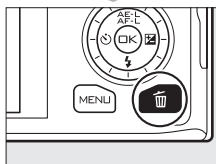





# Motion Snapshot Mode

Choose Motion Snapshot mode to record brief movie vignettes with your photographs. Each time the shutter is released, the camera records a still image and about a second of movie footage. When the resulting "Motion Snapshot" is viewed on the camera, the movie will play back in slow motion over approximately 2.5 s, followed by the still image.

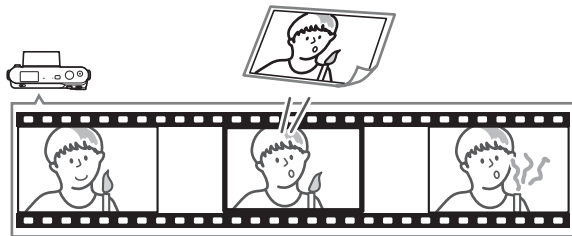

## Available Settings

For information on the options available in Motion Snapshot mode, see page 49.

## Shooting in Motion Snapshot Mode

### 1 Select Motion Snapshot mode.

Rotate the mode dial to .

Mode dial

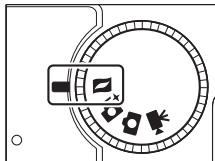

---

## 2 Frame the picture.

Holding the camera as shown on page 22, compose the photograph with your subject in the center of the frame.



---

## 3 Begin buffering.

Press the shutter-release button half-way to focus (☐ 23). An icon will be displayed as the camera begins recording footage to the memory buffer.



---

## 4 Shoot.

Smoothly press the shutter-release button the rest of the way down. The camera will record a photograph, together with about a second of movie footage beginning before and ending after the time the shutter-release button was pressed. Note that some time may be required. When recording is complete, the photograph will be displayed for a few seconds.



### **Buffering**

Buffering begins when the shutter-release button is pressed halfway and ends after about 90 seconds or when the shutter-release button is pressed all the way down.

*Shutter-release  
button pressed  
halfway to focus*

*Shutter-release button  
pressed all the way  
down*

*Shooting ends*



### **Choosing a Theme**

To choose the background music for the movie, press **F** and use the multi selector and  button to choose from **Beauty**, **Waves**, **Relaxation**, and **Tenderness**.

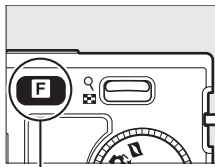



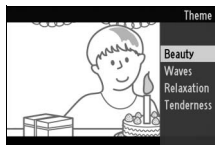

**F** button



### **Motion Snapshot Mode**



By default, the camera automatically chooses a scene mode appropriate to the subject (automatic scene selection;  21). Live audio is not recorded. Movies can not be recorded using the movie-record button and the flash can not be used.

## Viewing Motion Snapshots

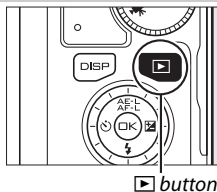
Press  and use the multi selector to display a Motion Snapshot ( 28; Motion Snapshots are indicated by a  icon). Pressing  when a Motion Snapshot is displayed plays back the movie portion in slow motion over a period of about 2.5 s, followed by the photo; the background track plays for about 10 s. To end playback and return to shooting mode, press the shutter-release button halfway.



## Deleting Motion Snapshots

To delete the current Motion Snapshot, press . A confirmation dialog will be displayed; press  again to delete the photo and movie and return to playback, or press  to exit without deleting the file. *Note that once deleted, Motion Snapshots can not be recovered.*

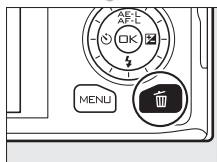
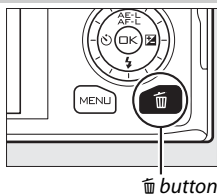



# Available Settings

The following table lists the settings that can be adjusted in each mode.

## ■ Still Image Mode/Smart Photo Selector Mode

	Still image mode					Smart Photo Selector mode				
		P	S	A	M		P	S	A	M
Exposure mode <sup>1</sup>										
Image quality	✓	✓	✓	✓	✓	✓				
Image size	✓	✓	✓	✓	✓	✓				
Continuous	✓	✓	✓	✓	✓	—				
Frame rate	—	—	—	—	—	—				
Movie settings	—	—	—	—	—	—				
Metering	—	✓ <sup>2</sup>	✓ <sup>2</sup>	✓ <sup>2</sup>	✓ <sup>2</sup>	—				
White balance	—	✓	✓	✓	✓	—				
ISO sensitivity	—	✓ <sup>2</sup>	✓ <sup>2</sup>	✓ <sup>2</sup>	✓ <sup>2</sup>	—				
Picture Control	—	✓	✓	✓	✓	—				
Color space	✓	✓	✓	✓	✓	✓				
Active D-Lighting	—	✓	✓	✓	✓	—				
Long exposure NR	✓ <sup>2</sup>	✓ <sup>2</sup>	✓ <sup>2</sup>	✓ <sup>2</sup>	✓ <sup>2</sup>	—				
High ISO noise reduction	✓	✓	✓	✓	✓	✓				
Fade in/fade out	—	—	—	—	—	—				
Movie sound options	—	—	—	—	—	—				
Interval timer shooting	—	✓ <sup>2</sup>	✓ <sup>2</sup>	✓ <sup>2</sup>	✓ <sup>2</sup>	—				
Vibration reduction <sup>3</sup>	✓	✓	✓	✓	✓	✓				
Focus mode	—	✓ <sup>2</sup>	✓ <sup>2</sup>	✓ <sup>2</sup>	✓ <sup>2</sup>	—				
AF-area mode	—	✓ <sup>4</sup>	✓ <sup>4</sup>	✓ <sup>4</sup>	✓ <sup>4</sup>	—				
Face-priority AF	—	✓ <sup>4</sup>	✓ <sup>4</sup>	✓ <sup>4</sup>	✓ <sup>4</sup>	—				
Built-in AF assist	✓	✓	✓	✓	✓	✓				
Flash compensation <sup>5</sup>	—	✓ <sup>2</sup>	✓ <sup>2</sup>	✓ <sup>2</sup>	✓ <sup>2</sup>	—				

Shooting menu



		Still image mode					Smart Photo Selector mode				
Exposure mode <sup>1</sup>			P	S	A	M		P	S	A	M
Other settings	Focus area selection	—	✓	✓	✓	✓	—				
	Flexible program	—	✓	—	—	—	—				
	Autoexposure Lock	—	✓	✓	✓	—	—				
	Focus lock	—	✓	✓	✓	✓	—				
	Self-timer	✓ <sup>2</sup>	✓ <sup>2</sup>	✓ <sup>2</sup>	✓ <sup>2</sup>	✓ <sup>2</sup>	—				
	Exposure compensation	—	✓ <sup>2</sup>	✓ <sup>2</sup>	✓ <sup>2</sup>	—	—				
	Flash mode	✓ <sup>2</sup>	✓ <sup>2</sup>	✓ <sup>2</sup>	✓ <sup>2</sup>	✓ <sup>2</sup>	—				
	Movie mode	—	—	—	—	—	—				
	Theme	—	—	—	—	—	—				

**1 P Programmed auto** is selected automatically when **Electronic (Hi)** is selected for **Continuous**.

**2** Not available when **Electronic (Hi)** is selected for **Continuous**.

**3** VR lenses only.

**4** Not available if a frame rate of 10 fps is chosen when **Electronic (Hi)** is selected for **Continuous**.

**5** Available only when built-in flash unit is raised.





## ■■ Movie Mode/Motion Snapshot Mode

Exposure mode	Movie mode					Motion Snapshot mode				
		P	S	A	M		P	S	A	M
Image quality	—	—	—	—	—	—	—	—	—	—
Image size	—	—	—	—	—	—	—	—	—	—
Continuous	—	—	—	—	—	—	—	—	—	—
Frame rate	—	✓ <sup>2</sup>	✓ <sup>2</sup>	✓ <sup>2</sup>	✓ <sup>2</sup>	—	—	—	—	—
Movie settings	✓ <sup>1</sup>	✓ <sup>1</sup>	✓ <sup>1</sup>	✓ <sup>1</sup>	✓ <sup>1</sup>	—	—	—	—	—
Metering	—	✓ <sup>1</sup>	✓ <sup>1</sup>	✓ <sup>1</sup>	✓ <sup>1</sup>	—	✓	✓	✓	✓
White balance	—	✓	✓	✓	✓	—	✓	✓	✓	✓
ISO sensitivity	—	✓	✓	✓	✓	—	✓	✓	✓	✓
Picture Control	—	✓	✓	✓	✓	—	✓	✓	✓	✓
Color space	—	—	—	—	—	—	—	—	—	—
Active D-Lighting	—	—	—	—	—	—	—	—	—	—
Long exposure NR	—	—	—	—	—	—	—	—	—	—
High ISO noise reduction	✓ <sup>1</sup>	✓	✓	✓	✓	✓	✓	✓	✓	✓
Fade in/fade out	✓ <sup>1</sup>	✓ <sup>1</sup>	✓ <sup>1</sup>	✓ <sup>1</sup>	✓ <sup>1</sup>	—	—	—	—	—
Movie sound options	✓ <sup>1</sup>	✓ <sup>1</sup>	✓ <sup>1</sup>	✓ <sup>1</sup>	✓ <sup>1</sup>	—	—	—	—	—
Interval timer shooting	—	—	—	—	—	—	—	—	—	—
Vibration reduction <sup>3</sup>	✓ <sup>1</sup>	✓	✓	✓	✓	✓	✓	✓	✓	✓
Focus mode	—	✓	✓	✓	✓	—	—	—	—	—
AF-area mode	—	✓ <sup>1</sup>	✓ <sup>1</sup>	✓ <sup>1</sup>	✓ <sup>1</sup>	—	✓	✓	✓	✓
Face-priority AF	—	✓ <sup>1</sup>	✓ <sup>1</sup>	✓ <sup>1</sup>	✓ <sup>1</sup>	—	✓	✓	✓	✓
Built-in AF assist	—	—	—	—	—	✓	✓	✓	✓	✓
Flash compensation	—	—	—	—	—	—	—	—	—	—

Shooting menu



		Movie mode					Motion Snapshot mode				
Exposure mode			P	S	A	M		P	S	A	M
Other settings	Focus area selection	—	✓ <sup>1</sup>	✓ <sup>1</sup>	✓ <sup>1</sup>	✓ <sup>1</sup>	—	✓	✓	✓	✓
	Flexible program	—	—	—	—	—	—	—	—	—	—
	Autoexposure Lock	—	✓	✓	✓	—	—	✓	✓	✓	—
	Focus lock	—	✓	✓	✓	✓	—	✓	✓	✓	✓
	Self-timer	✓ <sup>1</sup>	✓	✓	✓	✓	—	—	—	—	—
	Exposure compensation	—	✓	✓	✓	—	—	✓	✓	✓	—
	Flash mode	—	—	—	—	—	—	—	—	—	—
	Movie mode	✓ <sup>1</sup>	✓	✓	✓	✓	—	—	—	—	—
	Theme	—	—	—	—	—	✓	✓	✓	✓	✓

**1** HD movie selected in movie mode.

**2** Slow motion selected in movie mode.

**3** VR lenses only.







# More on Photography

## Self-Timer and Remote Control Modes

The self-timer and optional ML-L3 remote control (📖 158) can be used to reduce camera shake or for self-portraits. The following options are available:

<b>Off</b>	Self-timer and remote control off. The shutter is released when the camera shutter-release button is pressed.
🕒 10s <b>10 s</b>	The shutter is released 2, 5, or 10 seconds after the shutter-release button is pressed all the way down. Choose <b>2 s</b> to reduce camera shake, <b>5 s</b> or <b>10 s</b> for self-portraits.
🕒 5s <b>5 s</b>	
🕒 2s <b>2 s</b>	
🕒 2s <b>Delayed remote</b>	The shutter is released 2 s after the shutter-release button on the optional ML-L3 remote control is pressed.
📡 <b>Quick-response remote</b>	The shutter is released when the shutter-release button on the optional ML-L3 remote control is pressed.

### 🔧 Before Using the Remote Control

Before using the remote control for the first time, remove the clear plastic battery-insulator sheet.

## 1 Mount the camera on a tripod.

Mount the camera on a tripod or place the camera on a stable, level surface.

## 2 Display self-timer options.

Press ◀ (🕒) to display self-timer options.



### 3 Select the desired option.

Use the multi selector to highlight the desired option and press .

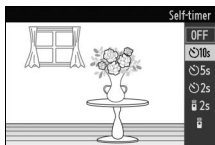

### 4 Frame the photograph and shoot.

**Self-timer mode:** Press the shutter-release button halfway to focus, and then press the button the rest of the way down. The self-timer lamp will start to blink and a beep will begin to sound. Two seconds before the photo is taken, the lamp will stop blinking and the beeping will become more rapid.

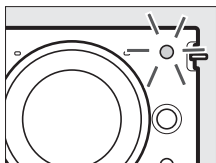

**Remote control mode:** Aim the ML-L3 at the infrared receiver on the camera ( 2) and press the ML-L3 shutter-release button (stand at a distance of 5 m/16 ft or less). In delayed remote mode, the self-timer lamp will light for about two seconds before the shutter is released. In quick-response remote mode, the self-timer lamp will flash after the shutter has been released.

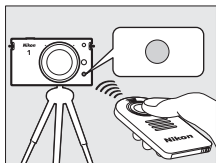

Note that the timer may not start or a photograph may not be taken if the camera is unable to focus or in other situations in which the shutter can not be released. Turning the camera off cancels self-timer and remote control modes. Remote control modes are cancelled automatically if no operations are performed for about five minutes after the mode is selected in Step 3.

#### **Movie Mode**

In self-timer mode, start and stop the timer by pressing the movie-record button instead of the shutter-release button. In remote control mode, the ML-L3 shutter-release button functions as the movie-record button.

#### **Using the Built-in Flash**

Slide the flash pop-up control to raise the flash before shooting. Shooting will be interrupted if the flash is raised while the self-timer or delayed-remote timer is counting down.

In remote control mode, the flash starts charging while the camera is waiting for the signal from the remote. The camera will only respond to the shutter-release button on the remote control when the flash is charged. If red-eye reduction (📖 58) is used in quick-response remote mode, the shutter will be released about one second after the red-eye reduction lamp lights. In delayed remote mode, there will be about a two second delay after the shutter-release button on the remote control is pressed; the red-eye reduction lamp will then light for about one second before the shutter is released.

#### **Tripod Mounting Spacer**

Use an optional TA-N100 tripod mounting spacer to prevent larger lenses coming into contact with the tripod head when the camera is mounted on a tripod (📖 159).

#### **See Also**

For information on choosing how long the camera will wait for a signal from the remote, see page 152. See page 151 for information on controlling the beeps that sound when the self-timer or remote control is used.



## Exposure Compensation

Exposure compensation is used to alter exposure from the value suggested by the camera, making pictures brighter or darker. Choose from values between  $-3$  EV (underexposure) and  $+3$  EV (overexposure) in increments of  $\frac{1}{3}$  EV. In general, positive values make the image brighter while negative values make it darker. Exposure compensation is not available in **S** Scene auto selector and **M** Manual exposure modes.



*-1 EV*



*No exposure compensation*



*+1 EV*

### 1 Display exposure compensation options.

Press **▶** (Z) to display exposure compensation options.



### 2 Select a value.

Use the multi selector to highlight the desired value and press **OK**.

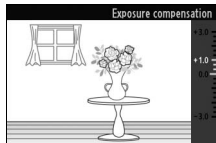

Normal exposure can be restored by setting exposure compensation to  $\pm 0$ . Exposure compensation is not reset when the camera is turned off.

### **Exposure Compensation**

Exposure compensation is most effective when used with center-weighted or spot metering (📖 117).

### **The Built-in Flash**

When used with the built-in flash, exposure compensation affects both background exposure and flash level.







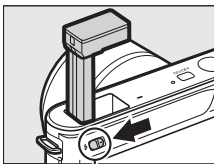

## The Built-in Flash

To use the flash, raise it by sliding the flash pop-up control and then choose a flash mode as described on the following page. Charging begins when the flash is raised; once charging is complete, a flash-ready indicator (●) will be displayed when the shutter-release button is pressed halfway.



*Flash pop-up control*

 <b>Fill flash</b>	The flash fires with every photograph taken. Use when the subject is poorly lit or with back-lit subjects to “fill in” (illuminate) shadows.
 <b>Red-eye reduction</b>	The red-eye reduction lamp lights before the flash fires, reducing “red-eye” caused by light reflecting from your subject’s retinas.
 <b>Red-eye reduction + slow sync</b>	Combines red-eye reduction with slow shutter speeds to capture background details at night or under low light. Use for portraits taken against a backdrop of night scenery.
 <b>Fill flash + slow sync</b>	Combines fill flash with slow shutter speeds to capture details of poorly-lit backgrounds.
 <b>Rear curtain + slow sync</b>	Combines rear-curtain sync (see below) with slow shutter speeds to capture poorly-lit background details.
 <b>Rear-curtain sync</b>	While in other modes the flash fires as the shutter opens, in rear-curtain sync the flash fires just before the shutter closes, creating streams of light that appear to follow moving light sources.

## Choosing a Flash Mode

### 1 Display the flash mode options.

Press the multi selector down to display a list of flash modes. The modes available depend on the exposure mode (📖 103).



SCENE	
⚡	Fill flash
⚡👁	Red-eye reduction

  

S, M	
⚡	Fill flash
⚡👁	Red-eye reduction
⚡REAR	Rear-curtain sync

P, A	
⚡	Fill flash
⚡👁	Red-eye reduction
⚡👁SLOW	Red-eye reduction + slow sync
⚡SLOW	Slow sync
⚡SLOW REAR	Rear curtain + slow sync

### 2 Select a flash mode.

Use the multi selector to highlight a flash mode (📖 58) and press **OK** to select.

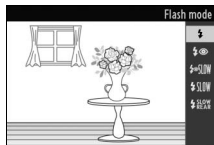

### Lowering the Built-in Flash

To save power when the flash is not in use, press it gently downward until the latch clicks into place. *Do not use force.* Failure to observe this precaution could result in product malfunction.

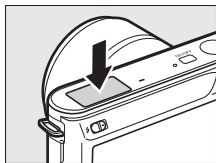

### Using the Built-in Flash

The built-in flash can be used in still image mode only. If the flash is fired multiple times in quick succession, the flash and shutter may be temporarily disabled to protect the flash. Shooting can be resumed after a brief pause.

Objects close to the camera may be overexposed in photographs taken with the flash at high ISO sensitivities.

To avoid vignetting, remove lens hoods and shoot at ranges of at least 0.6 m (2 ft). Some lenses may cause vignetting at greater distances or obstruct the red-eye reduction lamp, interfering with red-eye reduction; for more information, visit a Nikon website. The following illustrations show the effect of vignetting caused by shadows cast by the lens when the built-in flash is used.

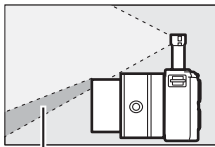

Shadow



Shadow

### See Also

For information on adjusting the flash level, see “Flash Compensation” (146).



### **Shutter Speed**

Shutter speed is restricted to the following ranges when a flash is used:

<b>Exposure mode</b>	<b>Shutter speed</b>
 <b>Scene auto selector (SCN)</b>	$\frac{1}{60}$ –1 s
<b>S Shutter-priority auto</b>	$\frac{1}{60}$ –30 s
<b>M Manual</b>	$\frac{1}{60}$ –30 s, Bulb
Other	$\frac{1}{60}$ s

### **Aperture, Sensitivity, and Flash Range**

Flash range varies with sensitivity (ISO equivalency) and aperture. With the standard zoom lens at maximum aperture and ISO sensitivity set to ISO 100 to 3200, the range is approximately 0.6 m–5.0 m (2 ft–16 ft) when the lens is zoomed all the way out, 0.6 m–3.0 m (2 ft–9.8 ft) at maximum zoom.





# More on Playback

## Photo Information

Photo information is superimposed on images displayed in full-frame playback ( 28). Press the **DISP** button to cycle through simple photo information ( 63), detailed photo information ( 64), and no photo information.

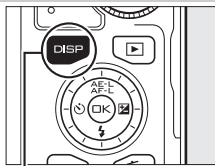

*DISP button*

## Simple Photo Information

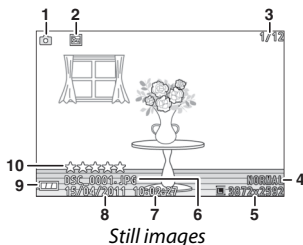

*Still images*

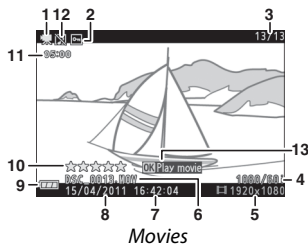

*Movies*

<b>1</b> Shooting mode .....	6	<b>7</b> Time of recording .....	18, 154
<b>2</b> Protect status .....	96	<b>8</b> Date of recording .....	18, 154
<b>3</b> Frame number/total number of images		<b>9</b> Battery indicator .....	20
<b>4</b> Image quality .....	114	<b>10</b> Rating .....	70
Frame rate .....	116	<b>11</b> Movie length .....	42
<b>5</b> Image size .....	114	<b>12</b> Audio recording indicator .....	134
Frame size .....	116	<b>13</b> On-screen guide (for movies) .....	42
<b>6</b> File name .....	115		

### Thumbnail Playback

Press **DISP** to view or hide ratings ( 70) when thumbnails are displayed ( 66). In four- and nine-frame playback, protect status ( 96) and frame numbers are also displayed.



## ■ Detailed Photo Information

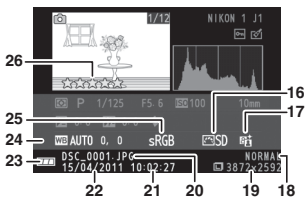
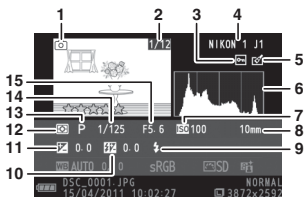

### Still images

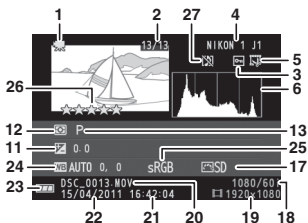

### Movies

<b>1</b> Shooting mode .....	6	<b>15</b> Aperture.....	110, 111
<b>2</b> Frame number/total number of images .....		<b>16</b> Picture Control .....	125
<b>3</b> Protect status.....	96	<b>17</b> Active D-Lighting indicator .....	132
<b>4</b> Camera name .....		<b>18</b> Image quality .....	114
<b>5</b> Retouch indicator .....	97, 98, 99	Frame rate .....	116
Movie edit indicator .....	100	<b>19</b> Image size.....	114
<b>6</b> Histogram showing distribution of tones in image .....	65	Frame size.....	116
<b>7</b> ISO sensitivity .....	124	<b>20</b> File name .....	115
<b>8</b> Focal length .....	186	<b>21</b> Time of recording .....	18, 154
<b>9</b> Flash mode.....	58	<b>22</b> Date of recording.....	18, 154
<b>10</b> Flash compensation.....	146	<b>23</b> Battery indicator.....	20
<b>11</b> Exposure compensation .....	56	<b>24</b> White balance.....	119
<b>12</b> Metering .....	117	White balance fine-tuning.....	120
<b>13</b> Exposure mode .....	106	<b>25</b> Color space.....	131
<b>14</b> Shutter speed .....	109, 111	<b>26</b> Rating .....	70
		<b>27</b> Audio recording indicator .....	134

## Histograms (📖 64)

Camera histograms are intended only as a guide and may differ from those in imaging applications. Sample histograms are shown below:

- **If brightness varies evenly across the image**, the distribution of tones will be relatively even.



- **If the image is dark**, tone distribution will be shifted to the left.



- **If the image is bright**, tone distribution will be shifted to the right.



Exposure compensation shifts the distribution of tones to the right when raised, to the left when lowered. Histograms can give you a rough idea of overall exposure when bright ambient lighting makes it difficult to see the display in the monitor.







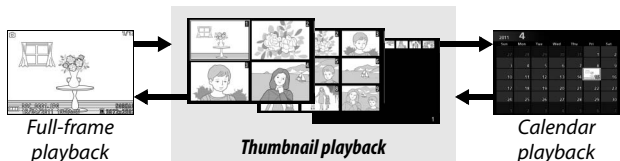
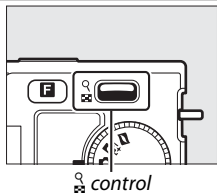

## Thumbnail Playback



To view pictures in “contact sheets” of 4, 9, or 72 images, press  down when a picture is displayed full frame.



The following operations can be performed:







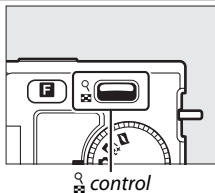

To	Use	Description
Display more images		Press down to increase the number of images displayed, up to decrease. Press down when 72 images are displayed to view images taken on selected dates (□ 67). Press up when 4 images are displayed to view the highlighted image full frame.
Display fewer images		
Highlight images		Use the multi selector to highlight images. You can delete (□ 69) or rate (□ 70) the highlighted image or zoom in for a closer look (□ 68).
View highlighted image		Press  to view the highlighted image full frame.
Delete highlighted image		See page 69.
Rate highlighted image		See page 70.
Exit to shooting mode		Press the shutter-release button halfway.

## Calendar Playback

To view pictures taken on a selected date, press  down when 72 pictures are displayed ( 66).



The following operations can be performed:

To	Use	Description
Highlight date	 	Use multi selector to highlight date.
View pictures taken on highlighted date		Press  to view the first picture taken on the highlighted date.
Delete pictures taken on highlighted date		Press  to delete all pictures taken on the highlighted date.
Exit to thumbnail display		Press  up to return to 72-frame display.
Exit to shooting mode		Press the shutter-release button half-way.







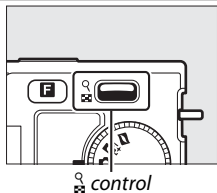





## Playback Zoom

To zoom in on a photograph, display it full frame and press  up. Playback zoom is not available with movies or Motion Snapshots.



The following operations can be performed:

To	Use	Description
Zoom in or out		Press up to zoom in, down to zoom out. Whenever you zoom in or out, a navigation window will appear with the area currently visible in the display indicated by a yellow border. 
View other areas of image		Press  ,  ,  , or  to scroll the image (keep pressed to scroll rapidly to other areas of the frame).
View faces		Faces (up to five) detected during zoom are indicated by white borders in the navigation window. Rotate the multi selector to view other faces. 
Exit zoom		Return to full-frame playback.
Exit to shooting mode		Press the shutter-release button halfway.



## Deleting Pictures

Pictures can be deleted from the memory card as described below. Note that once deleted, pictures can not be recovered; protected images, however, will not be deleted.

### Deleting the Current Picture

To delete the picture currently displayed in full-frame playback or selected in the thumbnail list, press . A confirmation dialog will be displayed; press again to delete the picture and return to playback, or press to exit without deleting the picture.

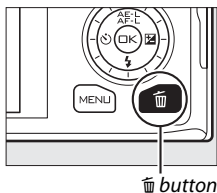

### The Playback Menu

To delete multiple images, press the MENU button, select **Delete** in the playback menu, and choose from the options below. A confirmation dialog will be displayed; select **Yes** to delete the images (note that some time may be required if a large number of images is selected).

<b>Delete selected images</b>	Highlight images and press  or  to select or deselect ( 95). Press  to exit when the selection is complete.
<b>Select images by date</b>	Highlight dates and press  to select or deselect. To view the pictures taken on the highlighted date, press  down; hold  up to view the highlighted picture full frame or press  down again to return to the date list. Press  to delete all pictures taken on the selected dates.
<b>Delete all images</b>	Delete all pictures on the memory card.
<b>Discard</b>	Delete all pictures rated  (discard;  70).



## Rating Pictures

Rate pictures or mark them as candidates for later deletion (📖 69). The **Slide show** option in the playback menu can be used to display only pictures with a selected rating or ratings (📖 71). Ratings can also be viewed in ViewNX 2. Rating is not available with protected images.

### 1 Select a picture.

Display a picture in full-frame playback or highlight it in the thumbnail list.

### 2 Press **F**.

Press **F** and rotate the multi selector to choose from ratings of zero to five stars, or select **🗑️** to mark the picture as a candidate for later deletion. The rating is stored when you press **OK** or display another picture.

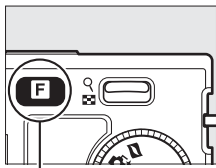

**F** button

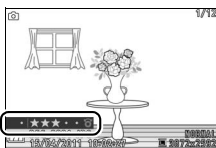

## Slide Shows

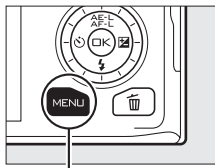

To view a slide show of the pictures on the memory card, press the **MENU** button, select **Slide show** in the playback menu, and follow the steps below.



MENU button

### 1 Select the type of image used in the show.

Highlight the desired option and press **OK**.

<b>All images</b>	Display all the images on the memory card.
<b>Still images</b>	Display still images only.
<b>Movies</b>	Display movies only.
<b>Motion Snapshot</b>	Display only the movie portion of Motion Snapshots. The associated photographs are not displayed.
<b>Select images by date</b>	Display only images recorded on a selected date. A calendar will be displayed; use the multi selector to highlight a date. 
<b>Selected scene</b>	Display only photos belonging to a specific scene, as determined by the automatic scene selector (☰ 21) when the pictures were taken. Choose from <b>Auto</b> , <b>Portrait</b> , <b>Landscape</b> , <b>Night portrait</b> , and <b>Close up</b> . 
<b>By rating</b>	Display only images with a selected rating or ratings (☰ 70). A rating selection dialog will be displayed; use the multi selector to highlight ratings and press ► to select or deselect. 
<b>Face priority</b>	Display only images in which the camera has detected a face (☰ 23).

---

## 2 Adjust display times and choose a background track.

Adjust the following options:

<b>Frame interval</b>	Choose how long each still image is displayed.
<b>Movie playback time</b>	Choose how much of each movie is played back before the next slide is displayed. Choose <b>Same as frame interval</b> to display the next slide after the time selected for <b>Frame interval</b> , <b>No limit</b> to play back the entire movie before displaying the next slide.
<b>Audio</b>	Mute audio playback or choose a slide show background track. Select <b>Movie sound tracks</b> to play only audio recorded with movies; in this case, no sound is played for still images or Motion Snapshots.





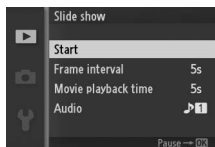

### 3 Select Start.

Highlight **Start** and press  $\text{OK}$  to start the slide show.



The following operations can be performed while a slide show is in progress:

To	Use	Description
Skip back/skip ahead		Press $\blacktriangleleft$ to return to the previous frame, $\blacktriangleright$ to skip to the next frame.
Pause/resume	$\text{OK}$	Pause the show. Press again to resume.
Adjust volume		Press up to increase volume, down to decrease.
Exit to playback mode		End the show and return to playback mode.
Exit to shooting mode		Press the shutter-release button halfway to exit to shooting mode.

The options shown at right are displayed when the show ends. Select **Resume** to restart or **Exit** to exit to the playback menu.





# Connections

## Installing the Supplied Software

Install the supplied software to copy pictures to your computer for viewing and editing pictures and creating short movies. Before installing the software, confirm that your system meets the requirements on page 77.

- 1 Start the computer and insert the installer ViewNX 2/ Short Movie Creator CD.

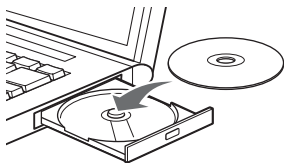

Windows

Mac OS



Nikon Software

Double-click icon  
on desktop



Welcome

Double-click  
**Welcome** icon

- 2 Select a language.

If the desired language is not available, click **Region Selection** to choose a different region and then choose the desired language (region selection is not available in the European release).

- 1 Select region (if required)



- 2 Select language

- 3 Click **Next**



---

### 3 Start the installer.

Click **Install** and follow the on-screen instructions.



---

### 4 Exit the installer.

Click **Yes** (Windows) or **OK** (Mac OS) when installation is complete.



*Click Yes*



*Click OK*

The following software is installed:

- ViewNX 2
- Short Movie Creator
- Apple QuickTime (Windows only)

---

### 5 Remove the installer CD from the CD-ROM drive.





## System Requirements

The system requirements for the Short Movie Creator are:

Windows	
<b>CPU</b>	2 GHz intel Core 2 Duo or better
<b>OS</b>	Pre-installed versions of Windows 7 Home Basic/Home Premium/Professional/Enterprise/Ultimate (Service Pack 1), Windows Vista Home Basic/Home Premium/Business/Enterprise/Ultimate (Service Pack 2), or Windows XP Home Edition/Professional (Service Pack 3). All installed programs run as 32-bit applications in 64-bit editions of Windows 7 and Windows Vista.
<b>RAM</b>	1.5 GB or more with at least 128 MB of video RAM (2 GB or more with at least 256 MB of video RAM recommended for creating HD movies)
<b>Hard-disk space</b>	A minimum of 500 MB available on the startup disk (1 GB or more recommended)
<b>Monitor</b>	<ul style="list-style-type: none"><li>• <b>Resolution:</b> 1,024 × 768 pixels (XGA) or more</li><li>• <b>Color:</b> 32-bit color (True Color) or more</li></ul>
<b>Other</b>	DirectX 9 or later and OpenGL 1.4 or later

Mac OS	
<b>CPU</b>	2 GHz intel Core 2 Duo or better
<b>OS</b>	Mac OS X version 10.5.8 or 10.6.7
<b>RAM</b>	1 GB or more
<b>Hard-disk space</b>	A minimum of 500 MB available on the startup disk (1 GB or more recommended)
<b>Monitor</b>	<ul style="list-style-type: none"><li>• <b>Resolution:</b> 1,024 × 768 pixels (XGA) or more</li><li>• <b>Color:</b> 24-bit color (millions of colors) or more</li></ul>

If your system does not meet the above requirements, only ViewNX 2 will be installed (☐ 79).



The system requirements for the ViewNX 2 are:

Windows	
<b>CPU</b>	<ul style="list-style-type: none"><li>• <b>Photos/JPEG movies:</b> Intel Celeron, Pentium 4, or Core series, 1.6 GHz or better</li><li>• <b>H.264 movies (playback):</b> 3.0 GHz or better Pentium D</li><li>• <b>H.264 movies (editing):</b> 2.6 GHz or better Core 2 Duo</li></ul>
<b>OS</b>	Pre-installed versions of Windows 7 Home Basic/Home Premium/Professional/Enterprise/Ultimate (Service Pack 1), Windows Vista Home Basic/Home Premium/Business/Enterprise/Ultimate (Service Pack 2), or Windows XP Home Edition/Professional (Service Pack 3). All installed programs run as 32-bit applications in 64-bit editions of Windows 7 and Windows Vista.
<b>RAM</b>	<ul style="list-style-type: none"><li>• <b>Windows 7/Windows Vista:</b> 1 GB or more (2 GB or more recommended)</li><li>• <b>Windows XP:</b> 512 MB or more (2 GB or more recommended)</li></ul>
<b>Hard-disk space</b>	A minimum of 500 MB available on the startup disk (1 GB or more recommended)
<b>Monitor</b>	<ul style="list-style-type: none"><li>• <b>Resolution:</b> 1024 × 768 pixels (XGA) or more (1280 × 1024 pixels (SXGA) or more recommended)</li><li>• <b>Color:</b> 24-bit color (True Color) or more</li></ul>

Mac OS	
<b>CPU</b>	<ul style="list-style-type: none"><li>• <b>Photos/JPEG movies:</b> PowerPC G4 (1 GHz or better), G5, Intel Core, or Xeon series</li><li>• <b>H.264 movies (playback):</b> PowerPC G5 Dual or Core Duo, 2 GHz or better</li><li>• <b>H.264 movies (editing):</b> 2.6 GHz or better Core 2 Duo</li></ul>
<b>OS</b>	Mac OS X version 10.5.8, or 10.6.7
<b>RAM</b>	512 MB or more (2 GB or more recommended)
<b>Hard-disk space</b>	A minimum of 500 MB available on the startup disk (1 GB or more recommended)
<b>Monitor</b>	<ul style="list-style-type: none"><li>• <b>Resolution:</b> 1024 × 768 pixels (XGA) or more (1280 × 1024 pixels (SXGA) or more recommended)</li><li>• <b>Color:</b> 24-bit color (millions of colors) or more</li></ul>

#### Motion Snapshots

ViewNX 2 is required to view Motion Snapshots on a computer.

# Viewing and Editing Pictures on a Computer

## Transferring Pictures

### 1 Choose how pictures will be copied to the computer.

Choose one of the following methods:

- **Direct USB connection:** Turn the camera off and ensure that the memory card is inserted in the camera. Connect the camera to the computer using the supplied USB cable (do not use force or insert the connectors at an angle) and then turn the camera on.

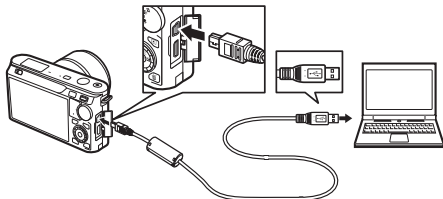

- **SD card slot:** If your computer is equipped with an SD card slot, the card can be inserted directly in the slot.
- **SD card reader:** Connect a card reader (available separately from third-party suppliers) to the computer and insert the memory card.

### 2 Start Nikon Transfer 2.

If a message is displayed prompting you to choose a program, select Nikon Transfer 2.

#### Windows 7

If the following dialog is displayed, select Nikon Transfer 2 as described below.

- 1 Under **Import pictures and videos**, click **Change program**. A program selection dialog will be displayed; select **Import File using Nikon Transfer 2** and click **OK**.



- 2 Double-click **Import file**.



### 3 Click Start Transfer.

At default settings, all the pictures on the memory card will be copied to the computer.



Click **Start Transfer**

### 4 Terminate the connection.

If the camera is connected to the computer, turn the camera off and disconnect the USB cable. If you are using a card reader or card slot, choose the appropriate option in the computer operating system to eject the removable disk corresponding to the memory card and then remove the card from the card reader or card slot.

## Viewing Pictures

Pictures are displayed in ViewNX 2 when transfer is complete.

#### Starting ViewNX 2 Manually

- **Windows:** Double-click the ViewNX 2 shortcut on the desktop.
- **Mac OS:** Click the ViewNX 2 icon in the Dock.

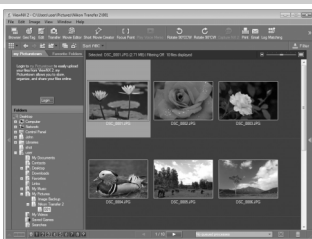

## ■ ■ Retouching Photographs

To crop pictures and perform such tasks as adjusting sharpness and tone levels, click the **Edit** button in the toolbar.



## ■ ■ Creating Short Movies

Use the Short Movie Creator to create short movies combining music, Motion Snapshots, movie footage, and photos taken in still image or Smart Photo Selector mode (82).

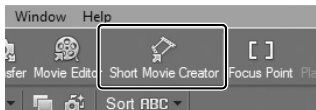

## ■ ■ Printing Pictures

Click the **Print** button in the toolbar. A dialog will be displayed, allowing you to print pictures on a printer connected to the computer.



### ■ For More Information

Consult online help for more information on using ViewNX 2.

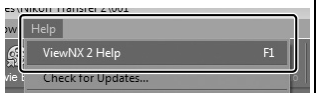

## Creating Short Movies

Use the supplied Short Movie Creator software to create movies combining photographs taken in still image or Smart Photo Selector mode with Motion Snapshots, movies, and music.

---

### 1 Transfer pictures.

Transfer pictures as described on page 79.

---

### 2 Select components.

Select pictures in ViewNX 2.

---

### 3 Start Short Movie Creator.

Click the **Short Movie Creator** button in ViewNX 2.

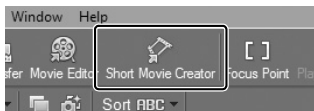

The images selected in Step 2 will be displayed in the Short Movie Creator “Components” panel; if desired, additional pictures can be dragged into the “Components” panel from ViewNX 2 and re-ordered using drag and drop. In the case of photos taken with the Smart Photo Selector, only the best shot will be displayed. The photo and movie components of Motion Snapshots appear as separate files.

*“Components” panel*



---

### 4 Select a style and background track.

Select a style in the “Styles” panel and a background track in the “Music” panel. To preview the movie, click .

## 5 Save the movie.

Click **Create Movie**. The dialog shown at right will be displayed; select one of the following options and click **Create**.

- **Save file:** Save the movie to a folder on the computer.
- **Save to Camera (memory card):** Save the movie to a memory card so that it can later be played back on the camera. To use this option, you will first need to insert a memory card that has been formatted in the camera (149) into a card reader or card slot.

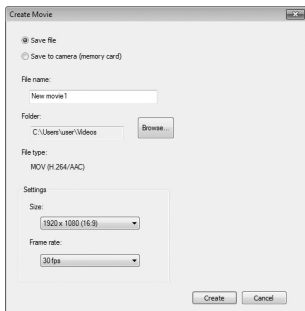

### Starting Short Movie Creator

If ViewNX 2 is not running, you can start Short Movie Creator by double-clicking the **Short Movie Creator** icon on the desktop (Windows) or clicking the **Short Movie Creator** icon in the Dock (Mac OS).

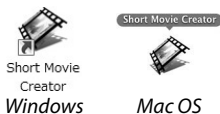

### Viewing Short Movies on Other Devices

Movies saved to a memory card using the **Save to Camera (memory card)** option in Short Movie Creator can be viewed on the camera, or displayed on a television monitor when the camera is connected to a TV (84). Movies created in other applications or using the **Save file** option in Short Movie Creator can not be viewed on the camera.

### For More Information

Consult online help for more information on using Short Movie Creator.

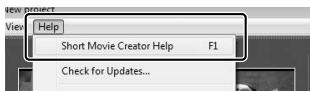

## Viewing Pictures on TV

Connect the camera to a television for playback.

### Connecting Video Cables

Always turn the camera off before connecting or disconnecting HDMI cables. When connecting cables, do not use force or attempt to insert the connectors at an angle.

## High-Definition Devices

A type C mini-pin High-Definition Multimedia Interface (HDMI) cable (available separately from third-party suppliers) can be used to connect the camera to high-definition video devices.

### 1 Connect the HDMI cable.

Turn the camera off and connect the HDMI cable.

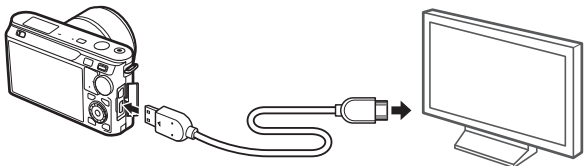

*Connect to camera*

*Connect to HD device  
(choose cable with  
appropriate connector)*

### 2 Tune the device to the HDMI channel.

### 3 Turn the camera on.

Turn the camera on; the camera monitor will remain off and the camera shooting mode display will appear on the HD device. Pictures can be played back using camera controls as described elsewhere in this manual; note that the edges of images may not be visible in the display. Stereo sound recorded with movies plays in stereo.



### ✔ Close the Connector Cover

Close the connector cover when the connectors are not in use. Foreign matter in the connectors can interfere with data transfer.

### ✔ Television Playback

Volume can be adjusted using the controls on the television; adjusting volume on the camera has no effect. Use of an EH-5b AC adapter and EP-5C power connector (available separately) is recommended for extended playback.

## ■ HDMI Device Control

To control the camera remotely from a device that supports HDMI-CEC (High-Definition Multimedia Interface–Consumer Electronics Control), select **On** for **HDMI device control** in the camera setup menu. The HDMI-CEC device will display a remote control guide and the remote control can be used in place of the following camera controls:

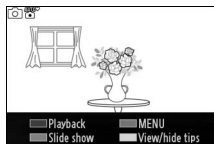

Camera	Remote control
▲, ▼, ◀, ▶	Up, down, left, and right buttons
⊙	Center button
▶	Blue button
MENU	Red button
Slide show menu (📖 71)	Green button

The remote control guide can be hidden or displayed at any time by pressing the yellow button on the remote control. See the television manual for details.



## Printing Photographs

Selected JPEG images can be printed on a PictBridge printer connected directly to the camera.

### Connecting the Printer

Connect the camera using the supplied USB cable.

#### 1 Turn the camera off.

#### 2 Connect the USB cable.

Turn the printer on and connect the USB cable as shown. Do not use force or attempt to insert the connectors at an angle.

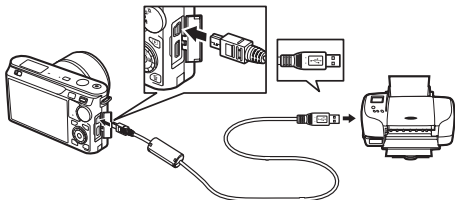

#### USB Hubs

Connect the camera directly to the printer; do not connect the cable via a USB hub.

#### 3 Turn the camera on.

A welcome screen will be displayed in the monitor, followed by a PictBridge playback display.

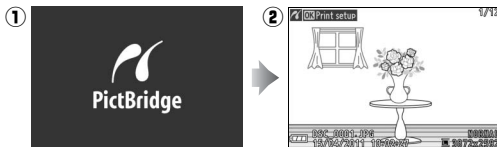





#### Printing Via Direct USB Connection

Be sure the EN-EL20 battery is fully charged or use an optional EH-5b AC adapter and EP-5C power connector.

## Printing Pictures One at a Time

### 1 Select a picture.

Press ◀ or ▶ to view additional pictures. Press  up to zoom in on the current frame (📖 68; press  down to exit zoom). To view nine pictures at a time, press  down when a picture is displayed full frame. Use the multi selector to highlight pictures, or press  up to display the highlighted picture full frame.

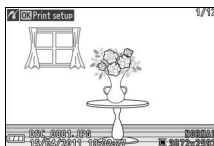

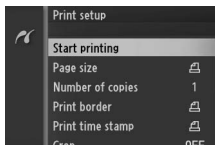

### 2 Adjust print options.

Press  to display PictBridge print options (📖 91). Press ▲ or ▼ to highlight options and press ▶ to select.



### 3 Start printing.

Highlight **Start printing** and press  to start printing. To cancel before all copies have been printed, press  again.



#### Selecting Photographs for Printing

Movies and NEF (RAW) photographs (📖 114) can not be selected for printing. If Motion Snapshots are selected, only the photographs will be printed; the movie portion will not be printed. If photographs taken with the Smart Photo Selector are selected, only the best shot will be printed.



### 1 Display the PictBridge menu.

Press the MENU button in the PictBridge playback display (see Step 3 on page 86).

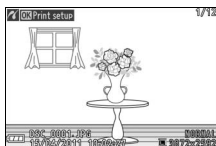

### 2 Choose an option.

Highlight one of the following options and press ►.

- **Select images for printing:** Select pictures for printing.
- **Select by date:** Print one copy of each picture taken on selected dates.
- **Print DPOF print order:** Print an existing print order created with the **DPOF print order** option in the playback menu (□ 92). The current print order will be displayed in Step 3.
- **Index print:** To create an index print of all JPEG pictures on the memory card, proceed to Step 4. Note that if the memory card contains more than 256 pictures, a warning will be displayed and only the first 256 images will be printed.

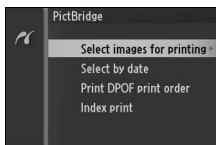

### 3 Select pictures or choose dates.

If you chose **Select images for printing** or **Print DPOF print order** in Step 2, press ◀ or ▶ or rotate the multi selector to highlight pictures. To select the current picture for printing, press ▲.

The picture will be marked with a 📄 icon and the number of prints will be set to 1; press ▲ or ▼ to specify the number of prints (up to 99; to deselect the picture, press ▼ when the number of prints is 1). Continue until all the desired pictures have been selected.



If you chose **Select by date** in Step 2, press ▲ or ▼ to highlight dates and press ▶ to select or deselect.

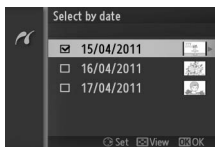





#### 🔍 Inspecting Pictures

To view pictures taken on the date highlighted in the **Select by date** date list, press ⏴ down. Use the multi selector to highlight pictures, or press ⏴ down to return to the date list.

The picture currently highlighted in the **Select images for printing** or **Print DPOF print order** displays or in the **Select by date** thumbnail display can be inspected by pressing ⏴ up; the picture will be displayed full screen while the button is pressed.



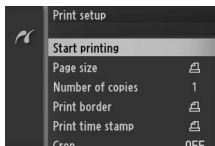

## 4 Adjust print options.

Press  to display PictBridge print options. Press  or  to highlight page size, border, or time stamp items and press  to display the options described on page 91; note that a warning will be displayed if the selected page size is too small for an index print.



## 5 Start printing.











Highlight **Start printing** and press  to start printing. To cancel before all copies have been printed, press  again.



### Errors

See page 176 for information on what to do if an error occurs during printing.

## PictBridge Print Options

<b>Page size</b>	Highlight a page size (only sizes supported by the current printer are listed) and press  to select and exit to the previous menu (to print at the default page size for the current printer, select <b>Use printer settings</b> ).
<b>Number of copies</b>	This option is listed only when pictures are printed one at a time. Press  or  to choose number of copies (maximum 99), then press  to select and return to the previous menu.
<b>Print border</b>	This option is listed only if supported by the printer. Highlight <b>Use printer settings</b> (use current printer settings), <b>Yes</b> (print white borders), or <b>No</b> (no borders) and press  to select and exit to the previous menu.
<b>Print time stamp</b>	Highlight <b>Use printer settings</b> (use current printer settings), <b>Yes</b> (print times and dates of recording on photos), or <b>No</b> (no time stamp) and press  to select and exit to the previous menu.
<b>Crop</b>	<p>This option is listed only when pictures are printed one at a time on a printer that supports cropping. To exit without cropping, highlight <b>No</b> and press . To crop the current picture, highlight <b>Yes</b> and press .</p> <p>Selecting <b>Yes</b> displays the dialog shown at right. Press  up to increase the size of the crop, down to decrease. Position the crop using the multi-selector and press . Note that print quality may drop if small crops are printed at large sizes.</p>

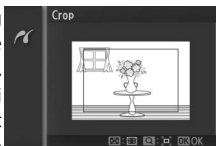

## Creating a DPOF Print Order: Print Set

The **DPOF print order** option is used to create digital “print orders” for PictBridge-compatible printers and devices that support DPOF. Press the MENU button, select **DPOF print order** in the playback menu, and choose from the following options:

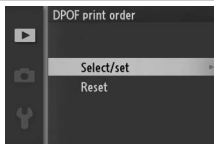

<b>Select/ set</b>	Press ◀ or ▶ or rotate the multi selector to highlight pictures (□ 95). To select the current picture for printing, press ▲. The picture will be marked with a 🖨 icon and the number of prints will be set to 1; press ▲ or ▼ to specify the number of prints (up to 99; to deselect the picture, press ▼ when the number of prints is 1). When the selection is complete, press Ⓞ to display printing options. Highlight <b>Print shooting info</b> (print the shutter speed and aperture on all pictures in the print order) or <b>Print date</b> (print the date of recording on all pictures in the print order) and press ▶ to select or deselect, and then press Ⓞ to complete the print order.	A screenshot of a camera's menu system. The title is 'DPOF print order'. There are three icons on the left: a play button, a camera, and a wrench. The main menu has two options: 'Print shooting info' (highlighted) and 'Print date'. At the bottom right, there are three icons: a play button, a camera, and a wrench, with the text 'Set' and 'OK' next to them.
<b>Reset</b>	Remove all pictures from the print order.	

### ✔ Print Set (DPOF)

DPOF date and shooting info options are not supported when printing via direct USB connection; to print the date of recording on photographs in the current print order, use the PictBridge **Print time stamp** option (□ 91).

The Print set (DPOF) option can not be used if there is not enough space on the memory card to store the print order. For restrictions on the types of images that can be selected for printing, see page 87.

Print orders may not print correctly if images are deleted using a computer or other device after the print order is created.



# The Playback Menu

To display the playback menu, press MENU and select the playback menu tab (▶).



MENU button

The playback menu contains the following options:

Option	Description	Default	
<b>Delete</b>	Delete multiple images.	—	69
<b>Slide show</b>	View movies and photos in a slide show.	Image type: All images Selected scene: Auto Frame interval: 5 s Movie playback time: Same as frame interval Audio: Background track 1	71
<b>Rotate tall</b>	Rotate “tall” (portrait-orientation) pictures for display during playback.	On	96
<b>DPOF print order</b>	Create digital “print orders”.	—	92
<b>Protect</b>	Protect pictures from accidental deletion.	—	96
<b>Rating</b>	Rate pictures.	—	96



Option	Description	Default	
<b>D-Lighting</b>	Brighten shadows in dark or back-lit photos, creating a retouched copy that is saved separately from the unmodified original.	—	97
<b>Resize</b>	Create small copies of selected pictures.	Choose size: 1.1 M	98
<b>Crop</b>	Create cropped copies of selected pictures.	—	99
<b>Edit movie</b>	Create copies of movies from which unwanted footage has been trimmed.	—	100

#### **Playback**

The camera may be unable to display or retouch images that were created or have been edited with other devices.

#### **Image Quality**

Copies created from JPEG photos are the same quality as the original, while copies created from NEF (RAW) photos are saved as fine-quality JPEG images.



## Selecting Multiple Images

Choosing the options listed below displays an image selection dialog. Press ◀ or ▶ or rotate the multi selector to highlight pictures (only pictures to which the operation applies are available for selection).



- **Delete > Delete selected images** (📖 69)
- **DPOF print order > Select/set** (📖 92)
- **Protect > Select/set** (📖 96)
- **D-Lighting** (📖 97)
- **Crop** (📖 99)
- **Rating** (📖 96)
- **Resize > Select images** (📖 98)
- **Edit movie** (📖 100)

### Inspecting Pictures

The picture currently highlighted in the thumbnail display can be inspected by pressing  up; the picture will be displayed full screen while the button is pressed.

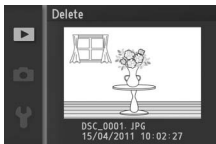

## Rotate Tall

Choose whether to rotate “tall” (portrait-orientation) pictures for display during playback. Note that because the camera itself is already in the appropriate orientation during shooting, images are not rotated automatically during image review.

<b>On</b>	“Tall” (portrait-orientation) pictures are automatically rotated for display in the camera monitor. Pictures taken with <b>Off</b> selected for <b>Auto image rotation</b> (☞ 155) will be displayed in “wide” (landscape) orientation.
<b>Off</b>	“Tall” (portrait-orientation) pictures are displayed in “wide” (landscape) orientation.

## Protect

Protect selected images from accidental deletion. Note that this option does NOT protect files from deletion when the memory card is formatted (☞ 149).

<b>Select/set</b>	Press ◀ or ▶ or rotate the multi selector to highlight pictures (☞ 95) and press ▲ or ▼ to select or deselect. Press Ⓞ to exit when the operation is complete.
<b>Reset</b>	Remove protection from all pictures.

## Rating

Press ◀ or ▶ or rotate the multi selector to highlight pictures (☞ 95) and press ▲ or ▼ to choose a rating (☞ 70). Press Ⓞ to exit when the operation is complete.



## D-Lighting

Applied to selected images, D-Lighting creates copies that have been processed to brighten shadows. Use to retouch dark or backlit photographs.

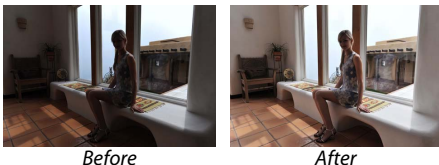

Press ◀ or ▶ or rotate the multi selector to highlight an image (📖 95) and press ⏹ to display the options shown at right. Press ▲ or ▼ to choose the amount of correction performed (the effect can be previewed in the display; hold 🔍 up to zoom in) and press ⏹ to create a retouched copy.

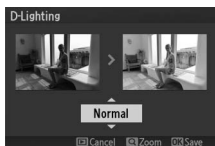

### D-Lighting

Noise (randomly-spaced bright pixels, fog, or lines) may appear in copies created with **D-Lighting**. Uneven shading may be visible with some subjects.

### Image Size

Copies created from JPEG photos are the same size as the original, while copies created from NEF (RAW) photos are saved as JPEG images with a size of 3,872 × 2,592.



## Resize

Create small copies of selected photographs. Select **Choose size** and choose a size from **1.1 M** (1,280 × 856 pixels), **0.6 M** (960 × 640 pixels), and **0.3 M** (640 × 424 pixels), and then choose **Select images**. Press ◀ or ▶ or rotate the multi selector to highlight pictures (95) and press ▲ or ▼ to select or deselect. When the selection is complete, press Ⓚ to display a confirmation dialog and select **Yes** to save the resized copies.



### Resized Copies

Playback zoom may not be available with resized copies.



## Crop

Create a cropped copy of selected photographs. Press ◀ or ▶ or rotate the multi selector to highlight a picture (📖 95) and press ⏹ to display the image with the default crop shown in yellow. Use the controls below to choose a crop and save the copy.

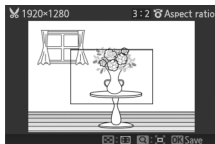

To	Use	Description
Choose size		Press  up or down to choose the crop size.
Choose aspect ratio		Rotate the multi selector to choose between aspect ratios of 3 : 2, 4 : 3, 1 : 1, and 16 : 9.
Position crop		Press ▲, ▶, ▼, or ◀ to position the crop. Press and hold to move the crop rapidly to the desired position.
Create copy		Save the current crop as a separate file.

### Cropped Copies

Playback zoom may not be available with resized copies. The size of the copy varies with crop size and aspect ratio and appears at upper left in the crop display.

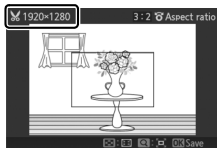

## Edit Movie

Trim footage from movies to create edited copies.

### 1 Select **Choose start point** or **Choose end point**.

Choose from the following options:

- **Choose start point:** Trim the opening footage.
- **Choose end point:** Trim the closing footage.

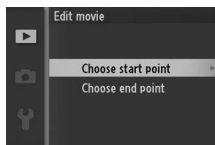

### 2 Select a movie.

Press ◀ or ▶ or rotate the multi selector to highlight a movie (📖 95) and press Ⓞ to select.

### 3 Pause the movie on opening or closing frame.

Play the movie back, pressing Ⓞ to begin and resume playback and ▼ to pause (📖 42; the first frame is indicated by a ⏮ icon in the display, the last frame by ⏭). Pause playback when you reach the frame that will become the new opening or closing frame.



### 4 Delete the unwanted frames.

Press ▲ to delete all frames before (**Choose start point**) or after (**Choose end point**) the current frame.

### 5 Save the copy.

Highlight **Yes** and press Ⓞ to save the edited copy. If necessary, the copy can be trimmed as described above to remove additional footage. Edited copies are indicated by a 📄 icon in full-frame playback.

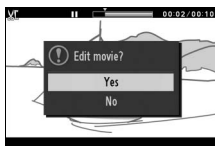



### **Trimming Movies**

Movies must be at least two seconds long. If a copy can not be created at the current playback position, the current position will be displayed in red in Step 4 and no copy will be created. The copy will not be saved if there is insufficient space available on the memory card.

To prevent the camera from turning off unexpectedly, use a fully-charged battery when editing movies.





# The Shooting Menu

To display the shooting menu, press MENU and select the shooting menu tab (📷, 📷, 📷, or 📷).



MENU button

The shooting menu contains the following options:

Option	Description	Default	
<b>Reset shooting options</b>	Reset shooting options to default values.	—	105
<b>Exposure mode</b>	Choose how the camera sets shutter speed and aperture.	SCENE Scene auto selector	106
<b>Image quality</b>	Choose a file format and compression ratio.	JPEG normal	114
<b>Image size</b>	Choose a size for new photos.	3872×2592	114
<b>Continuous</b>	Take photos one at a time or in a burst.	Single frame	26
<b>Frame rate</b>	Choose a frame rate for slow-motion movies (📖 40).	400 fps	116
<b>Movie settings</b>	Choose HD movie frame size and frame rate (📖 37).	1080/60i	116
<b>Metering</b>	Choose how the camera meters exposure.	Matrix	117



Option	Description	Default	
<b>White balance</b>	Adjust settings for different types of lighting.	Auto	119
<b>ISO sensitivity</b>	Control the camera's sensitivity to light.	Auto (100–3200)	124
<b>Picture Control</b>	Choose how the camera processes pictures.	Standard	125
<b>Custom Picture Control</b>	Create custom Picture Controls.	—	129
<b>Color space</b>	Choose a color space for new pictures.	sRGB	131
<b>Active D-Lighting</b>	Avoid loss of detail in highlights and shadows.	On	132
<b>Long exposure NR</b>	Reduce noise in long time-exposures.	Off	133
<b>High ISO noise reduction</b>	Reduce noise at high ISO sensitivities.	On	133
<b>Fade in/fade out</b>	Shoot HD movies with fade in/fade out effects.	None	133
<b>Movie sound options</b>	Choose sound recording options.	Microphone: Auto sensitivity (A) Wind noise reduction: On	134
<b>Interval timer shooting</b>	Take photos at a pre-selected interval.	00:01':00", 001	135
<b>Vibration reduction</b>	Adjust settings for lenses with vibration reduction.	Active/On <sup>1</sup>	136
<b>Focus mode</b>	Choose how the camera focuses.	See page 137	137
<b>AF-area mode</b>	Choose how the focus area is selected.	Auto-area <sup>2</sup>	142



Option	Description	Default	
<b>Face-priority AF</b>	Turn face-priority AF on or off.	On <sup>3</sup>	145
<b>Built-in AF assist</b>	Control the built-in AF-assist illuminator.	On	145
<b>Flash compensation</b>	Control flash output.	0.0	146

**1** Varies with lens ( 136).

**2** The camera focuses on the subject in the center of the frame when **10 fps** is selected for **Electronic (Hi)** or **Slow motion** is selected as the movie type.

**3** Face detection is not available when **10 fps** is selected for **Electronic (Hi)** or **Slow motion** is selected as the movie type.

## Reset Shooting Options

Select **Yes** to reset the options in the shooting menu and other shooting settings to default values ( 103).



## Exposure Mode

The options in the exposure mode menu offer varying degrees of control over shutter speed and aperture.

 <b>Scene auto selector</b>	An automatic, “point-and-shoot” mode in which the camera not only chooses shutter speed and aperture but adjusts other settings to suit the subject (□ 21).
<b>P Programmed auto</b>	The camera sets shutter speed and aperture for optimal exposure (□ 108).
<b>S Shutter-priority auto</b>	You choose the shutter speed; the camera selects an aperture for best results (□ 109).
<b>A Aperture-priority auto</b>	You choose the aperture; the camera selects a shutter speed for best results (□ 110).
<b>M Manual</b>	You control both shutter speed and aperture (□ 111). Set shutter speed to “Bulb” or “Time” for long time-exposures.

### **ISO Sensitivity (P, S, A, and M Modes)**

When an “auto” option is selected for **ISO sensitivity**, the camera will automatically adjust sensitivity within the selected range if optimal exposure can not be achieved at the selected shutter speed or aperture.



## Shutter Speed and Aperture

The same exposure can be achieved with different combinations of shutter speed and aperture. Fast shutter speeds and large apertures freeze moving objects and soften background details, while slow shutter speeds and small apertures blur moving objects and bring out background details.

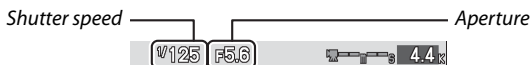

*Fast shutter speed ( $1/1,600$  s)*

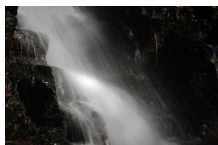

*Slow shutter speed (1 s)*



*Large aperture (f/5.6)*



*Small aperture (f/16)  
(Remember, the higher the  
f-number, the smaller the aperture.)*



## P Programmed Auto

In this mode, the camera automatically adjusts shutter speed and aperture for optimal exposure in most situations. This mode is recommended for snapshots and other situations in which you want to leave the camera in charge of shutter speed and aperture.

### 1 Choose a combination of shutter speed and aperture.

Although the shutter speed and aperture chosen by the camera will produce optimal results, you can also choose from other combinations that will produce the same exposure (“flexible program”). Press  up for large apertures (low f-numbers) that blur background details or fast shutter speeds that “freeze” motion. Press down for small apertures (high f-numbers) that increase depth of field or slow shutter speeds that blur motion. **\*** is displayed while flexible program is in effect.

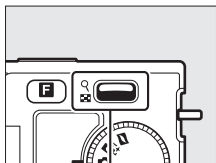

 control

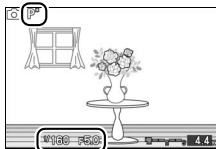

### 2 Frame a photograph, focus, and shoot.

#### Restoring Default Shutter Speed and Aperture Settings

To restore default shutter speed and aperture settings, press  up or down until **\*** is no longer displayed, choose another mode, rotate the mode dial, or turn the camera off. The default shutter speed and aperture is automatically restored when the camera enters standby mode.





## S Shutter-Priority Auto

In shutter-priority auto, you choose the shutter speed while the camera automatically selects the aperture that will produce the optimal exposure. Use slow shutter speeds to suggest motion by blurring moving subjects, fast shutter speeds to “freeze” motion.



Fast shutter speed ( $1/1,600$  s)

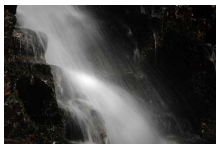

Slow shutter speed (1 s)

### 1 Choose a shutter speed.

Press  up for faster shutter speeds, down for slower shutter speeds. Choose from values between 30 s and  $1/16,000$  S.

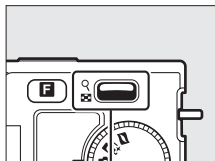

 control

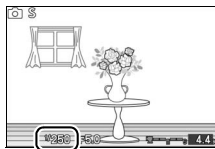

### 2 Frame a photograph, focus, and shoot.



## A Aperture-Priority Auto

In aperture-priority auto, you choose the aperture while the camera automatically selects the shutter speed that will produce the optimal exposure. Large apertures (low f-numbers) reduce depth of field, blurring objects behind and in front of the main subject. Small apertures (high f-numbers) increase depth of field, bringing out details in the background and foreground. Short field depths are generally used in portraits to blur background details, long field depths in landscape photographs to bring the foreground and background into focus.



Large aperture (f/5.6)



Small aperture (f/16)

### 1 Choose an aperture.

Press  up for smaller apertures (higher f-numbers), down for larger apertures (lower f-numbers). The minimum and maximum values depend on the lens currently in use.

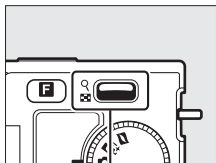

 control

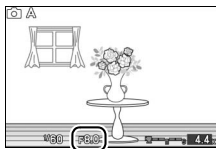

### 2 Frame a photograph, focus, and shoot.

## M Manual

In manual exposure mode, you control both shutter speed and aperture.

### 1 Choose shutter speed and aperture.

Adjust shutter speed and aperture with reference to the exposure indicator (see below). Shutter speed is set by pressing  up for faster speeds and down for slower speeds: choose from values between 30 s and  $\frac{1}{16,000}$  s or select “Bulb” or “Time” to hold the shutter open indefinitely for a long time-exposure. Aperture is selected by rotating the multi selector clockwise for smaller apertures (higher f-numbers) and counterclockwise for larger apertures (lower f-numbers): choose from values between the minimum and maximum for the lens.

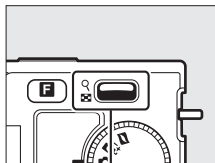

 control

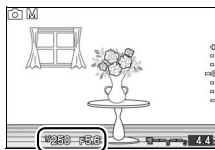

### 2 Frame a photograph, focus, and shoot.

#### The Exposure Indicator

When shutter speeds other than “Bulb” or “Time” are selected, the exposure indicator shows whether the photograph would be under- or over-exposed at current settings.

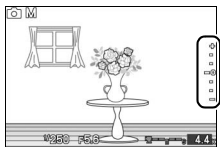

Optimal exposure	Underexposed by $\frac{1}{3}$ EV	Overexposed by over 2 EV
+	+	+
.	.	.
.	.	.
-0	=0	0
.	.	.
.	.	.
-	-	-

## ■ ■ Long Time-Exposures (Manual Exposure Mode Only)

Select the following shutter speeds for long time-exposures of moving lights, the stars, night scenery, or fireworks.

- **Bulb:** The shutter remains open while the shutter-release button is held down. To prevent blur, use a tripod.
- **Time:** Requires an optional ML-L3 remote control (☞ 158). Start the exposure by pressing the ML-L3 shutter-release button. The shutter remains open until the button is pressed a second time.



---



### 1 Ready the camera.

Mount the camera on a tripod or place it on a stable, level surface. To prevent loss of power before the exposure is complete, use a fully charged EN-EL20 battery or an optional EH-5b AC adapter and EP-5C power connector. Note that noise (bright spots, randomly-spaced bright pixels, or fog) may be present in long exposures; before shooting, choose **On** for **Long exposure NR** in the shooting menu (☞ 133).



---

## 2 Choose a shutter speed.

Press  down until “Bulb” is selected for shutter speed. For a shutter speed of “Time”, select a remote control mode ( 53) after choosing the shutter speed.

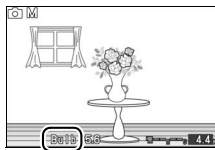
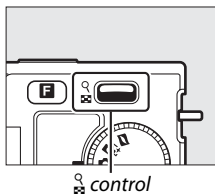

---

## 3 Open the shutter.

**Bulb:** After focusing, press the shutter-release button all the way down. Keep the shutter-release button pressed until the exposure is complete.

**Time:** Press the ML-L3 shutter-release button all the way down. The shutter will open immediately or after a two-second delay.

---

## 4 Close the shutter.

**Bulb:** Take your finger off the shutter-release button.

**Time:** Press the ML-L3 shutter-release button all the way down.

Shooting ends automatically after two minutes. Note that some time may be required to record long exposures.





## Image Quality

Choose a file format and compression ratio for photographs taken in still image and Smart Photo Selector modes.

Option	File type	Description
NEF (RAW)	NEF	Compressed 12-bit raw data from the image sensor are saved directly to the memory card. White balance, contrast, and other settings can be adjusted on a computer after shooting.
JPEG fine	JPEG	Record JPEG images at a compression ratio of roughly 1 : 4 (fine quality).
JPEG normal		Record JPEG images at a compression ratio of roughly 1 : 8 (normal quality).
JPEG basic		Record JPEG images at a compression ratio of roughly 1 : 16 (basic quality).
NEF (RAW) + JPEG fine	NEF/ JPEG	Two images are recorded: one NEF (RAW) image and one fine-quality JPEG image.

## Image Size

Choose the size of photographs taken in still image and Smart Photo Selector modes.

Option	Size (pixels)	Approximate print size at 300 dpi (cm/in.)*
 3872×2592	3,872 × 2,592	32.8 × 21.9/12.9 × 8.6
 2896×1944	2,896 × 1,944	24.5 × 16.5/ 9.7 × 6.5
 1936×1296	1,936 × 1,296	16.4 × 11 / 6.5 × 4.3

\* Print size in inches equals image size in pixels divided by printer resolution in dots per inch (dpi; 1 inch=approximately 2.54 cm).





### **NEF (RAW)/NEF (RAW) + JPEG**

The option selected for image size does not affect the size of NEF (RAW) images. NEF (RAW) images can be viewed on the camera or using software such as Capture NX 2 (available separately;  158) or ViewNX 2 (supplied).

When photographs taken at NEF (RAW) + JPEG are viewed on the camera, only the JPEG image will be displayed. When photographs taken at these settings are deleted, both NEF and JPEG images will be deleted.

### **File Names**

Photos and movies are stored as image files with names of the form “xxx\_nnnn.yyy,” where xxx is either NMS (Motion Snapshots) or DSC (other photos and movies), nnnn a four-digit number between 0001 and 9999 assigned automatically in ascending order by the camera, and yyy one of the following three letter extensions: “NEF” for NEF (RAW) images, “JPG” for JPEG images, or “MOV” for movies. The NEF and JPEG files recorded at settings of NEF (RAW)+JPEG have the same file names but different extensions. Trimmed copies created with **Edit movie** ( 100) have file names beginning with “DSC\_”; copies created with the other retouch options in the playback menu have file names beginning with “CSC” (e.g., “CSC\_0001.JPG”). Images recorded with **Adobe RGB** selected for **Color space** ( 131) have names that begin with an underscore (e.g., “\_DSC0001.JPG”).

### **Image Quality and Size**

Together, image quality and size determine how much space each photograph occupies on the memory card. Larger, higher quality images can be printed at larger sizes but also require more memory, meaning that fewer such images can be stored on the memory card ( 169).



## Frame Rate

Choose a frame rate for slow motion movies (📖 40). The faster the frame rate, the smaller the frame size.

Option	Frame size (pixels)	Bit rate (approx.)	Maximum length (shooting)	Maximum length (playback)*
400 fps	640 × 240	1.8 Mbps	5 seconds	1 minute 6 seconds
1200 fps	320 × 120	0.6 Mbps	5 seconds	3 minutes 20 seconds



\* All figures are approximate. Slow motion movies will play back over a period of about 13.2 (400 fps) or 40 (1200 fps) times the recording time.

### See Also

For information on the total length of movies that can be stored on the memory card, see page 169.

## Movie Settings

Choose a frame size and frame rate for HD movies (📖 37).

Option	Frame size (pixels)	Recording rate	Bit rate (approx.)	Maximum length
 <b>1080/60i</b>	1,920 × 1,080	59.94 fields/s*	24 Mbps	20 minutes
 <b>1080/30p</b>	1,920 × 1,080	29.97 fps	24 Mbps	20 minutes
 <b>720/60p</b>	1,280 × 720	59.94 fps	16 Mbps	29 minutes

\* Sensor output is about 60 fps.

### Photo Frame Size

Photographs recorded by pressing the shutter-release button all the way down during movie recording (📖 39) have an aspect ratio of 16 : 9. The frame size varies with the option selected for **Movie settings**:

- **1080/60i**: 3,840 × 2,160
- **1080/30p**: 1,920 × 1,080
- **720/60p**: 1,280 × 720

### See Also





For information on the total length of movies that can be stored on the memory card, see page 169.





## Metering

Choose how the camera sets exposure. Regardless of the option selected, metering is automatically adjusted to suit the scene when  **Scene auto selector** is selected for **Exposure mode**.

 <b>Matrix</b>	The camera meters a wide area of the frame and adjusts for contrast (tone distribution), color, composition, and subject distance, producing natural results in most situations.
 <b>Center-weighted</b>	The camera meters the entire frame but assigns the greatest weight to the center area. This is the classic meter for portraits and is recommended if you are using filters with an exposure factor (filter factor) over 1×.
 <b>Spot</b>	The camera meters the current focus area; use to meter off-center subjects (if <b>Auto-area</b> is selected for <b>AF-area mode</b> as described on page 142, the camera will meter the center focus area, while during face-priority AF the camera will meter the focus area closest to the center of the selected face;  23). Spot metering ensures that the subject will be correctly exposed, even when framed against a background that is much brighter or darker.



## Autoexposure Lock

Exposure lock is used to recompose photographs after metering exposure. It is most effective when used with center-weighted or spot metering (📖 117) to frame off-center subjects that are much brighter or darker than their surroundings or to optimize exposure for an object other than your main subject.

### 1 Meter exposure.

Position the subject in the center of the frame and press the shutter-release button halfway to meter exposure. Check that the focus area is displayed in green.

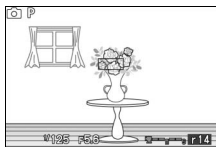

### 2 Lock exposure.

With the shutter-release button pressed halfway and the subject positioned in the focus area, press  $\blacktriangle$  (AE-L) to lock exposure. While exposure lock is in effect, an AE-L indicator will be displayed. Exposure will remain locked while  $\blacktriangle$  (AE-L) is pressed, even if you later remove your finger from the shutter-release button.

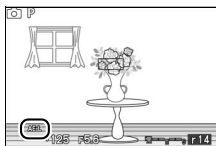

#### See Also







For information on changing the role of the  $\blacktriangle$  (AE-L) button, see page 152.

### 3 Recompose the photograph.

Keeping the  $\blacktriangle$  (AE-L) button pressed, recompose the photograph and shoot. The option selected for **Metering** can not be changed while exposure lock is in effect.

## White Balance

White balance ensures that colors are unaffected by the color of the light source. Auto white balance is recommended for most light sources, but other values can be selected if necessary according to the type of source. Regardless of the option selected, white balance is automatically adjusted to suit the scene if  **Scene auto selector** is selected for **Exposure mode**.

AUTO <b>Auto</b>	Automatic white balance adjustment. Recommended in most situations.
 <b>Incandescent</b>	Use under incandescent lighting.
 <b>Fluorescent</b>	Use with cool-white fluorescent lighting.
 <b>Direct sunlight</b>	Use with subjects lit by direct sunlight.
 <b>Flash</b>	Use with the built-in flash.
 <b>Cloudy</b>	Use in daylight under overcast skies.
 <b>Shade</b>	Use in daylight with subjects in the shade.
PRE <b>Preset manual</b>	Measure white balance (  121).



## Fine-Tuning White Balance

Options other than **Preset manual** can be fine-tuned as follows:

### 1 Display fine-tuning options.

Highlight an option other than **Preset manual** and press **▶** to display the fine-tuning options shown at right.

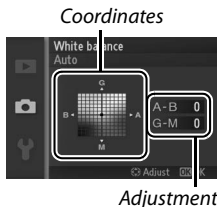

### 2 Fine-tune white balance.

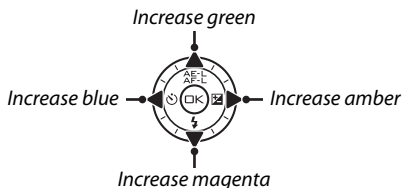

Use the multi selector to fine-tune white balance.



#### White Balance Fine Tuning

The colors on the fine-tuning axes are relative, not absolute. For example, moving the cursor to **B** (blue) when a “warm” setting such as  (incandescent) is selected will make photographs slightly “colder” but will not actually make them blue.

### 3 Save changes and exit.

Press **OK**. An asterisk will appear next to the white balance icon ( 4) in the detailed display ( 5) to show that white balance has been altered from default values.

## Preset Manual

---

Preset manual is used to record and recall custom white balance settings for shooting under mixed lighting or to compensate for light sources with a strong color cast.

---

### 1 Light a reference object.

Place a neutral gray or white object under the lighting that will be used in the final photograph. A standard gray panel can be used for increased precision.

---

### 2 Select Preset manual.

Highlight **Preset manual** in the white balance menu and press ►. The dialog shown at right will be displayed; highlight **Yes** and press (OK) to overwrite the existing value for preset manual white balance.



The message shown at right will be displayed.

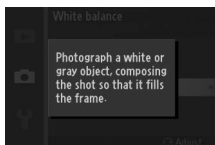

---

### 3 Measure white balance.

When the camera is ready to measure white balance, a flashing PRE will be displayed. Before the indicator stops flashing, frame the reference object so that it fills the display and press the shutter-release button all the way down. No photograph will be recorded; white balance can be measured accurately even when the camera is not in focus.



---

### 4 Check the results.

If the camera was able to measure a value for white balance, the message shown at right will be displayed. To return to shooting mode immediately, press the shutter-release button half-way.

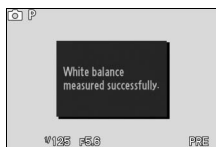

If lighting is too dark or too bright, the camera may be unable to measure white balance. The message at right will be displayed. Return to Step 3 and measure white balance again.



### ☑ Auto Power Off







White balance measurement will end without a new value being acquired if no operations are performed for the time selected for **Auto power off** in the setup menu (☐ 151; the default is 30 s).

### ☑ Preset White Balance

The camera can store only one value for preset white balance at a time; the existing value will be replaced when a new value is measured. Note that exposure is automatically increased by 1 EV when measuring white balance; if **M Manual** is selected for **Exposure mode**, adjust exposure so that the exposure indicator shows  $\pm 0$  (☐ 111).

### ☑ Color Temperature

The perceived color of a light source varies with the viewer and other conditions. Color temperature is an objective measure of the color of a light source, defined with reference to the temperature to which an object would have to be heated to radiate light in the same wavelengths. While light sources with a color temperature in the neighborhood of 5,000–5,500 K appear white, light sources with a lower color temperature, such as incandescent light bulbs, appear slightly yellow or red. Light sources with a higher color temperature appear tinged with blue. The camera white balance options are adapted to the following color temperatures:

- Sodium-vapor lamps: **2,700 K**
-  (incandescent)/  
Warm-white fluorescent: **3,000 K**
- White fluorescent: **3,700 K**
-  Cool-white fluorescent: **4,200 K**
- Day white fluorescent: **5,000 K**
-  (direct sunlight): **5,200 K**
-  (flash): **5,400 K**
-  (cloudy): **6,000 K**
- Daylight fluorescent: **6,500 K**
- Mercury-vapor lamps: **7,200 K**
-  (shade): **8,000 K**



## ISO Sensitivity

“ISO sensitivity” is the digital equivalent of film speed. The higher the sensitivity, the less light needed to make an exposure, allowing faster shutter speeds or smaller apertures, but the more likely the image is to be affected by “noise” in the form of randomly-spaced bright pixels, fog, or lines. Noise is particularly likely at a setting of **Hi 1** (equivalent to ISO 6400).

<b>A3200 Auto (100–3200)</b>	The camera adjusts ISO sensitivity in response to lighting conditions. ISO sensitivity is adjusted in the range given in brackets; choose larger ranges for increased sensitivity when lighting is poor, smaller ranges to reduce noise.
<b>A800 Auto (100–800)</b>	
<b>A400 Auto (100–400)</b>	
<b>100, 200, 400, 800, 1600, 3200, Hi 1</b>	ISO sensitivity is fixed at the selected value.

### **Auto (100–3200)/Auto (100–800)/Auto (100–400)**



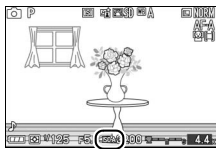



**ISO-A** appears at the bottom of the display when auto ISO sensitivity control is in effect.





## Picture Control

Choose how the camera processes photographs. Regardless of the option selected, the camera automatically chooses Picture Controls to suit the scene when **SCENE** Scene auto selector is selected for **Exposure mode**.

 <b>Standard</b>	Standard processing for balanced results. Recommended in most situations.
 <b>Neutral</b>	Minimal processing for natural results. Choose for photographs that will later be extensively processed or retouched.
 <b>Vivid</b>	Pictures are enhanced for a vivid, photoprint effect. Choose for photographs that emphasize primary colors.
 <b>Monochrome</b>	Take monochrome photographs.
 <b>Portrait</b>	Process portraits for natural texture and a rounded feel.
 <b>Landscape</b>	Take vibrant photographs of landscapes and cityscapes.

### Modifying Picture Controls

Existing preset and custom Picture Controls (📖 129) can be modified to suit the scene or your creative intent.

#### 1 Display options.

Highlight an item in the Picture Control menu and press ► to display Picture Control settings (📖 127; the settings available with custom Picture Controls are the same as the preset controls on which they are based). To use an unmodified Picture Control, highlight it and press .



## 2 Adjust settings.

Press ▲ or ▼ to highlight the desired setting and press ◀ or ▶ to choose a value. Repeat this step until all settings have been adjusted, or select

**Quick adjust** (📖 127) to choose a preset combination of settings. Default settings can be restored by pressing the 🗑️ button.



## 3 Save changes and exit.

Press .

### Preset Picture Controls Versus Custom Picture Controls

The Picture Controls supplied with the camera are referred to as *preset Picture Controls*. *Custom Picture Controls* are created through modifications to existing Picture Controls using the **Custom Picture Control** option in the shooting menu (📖 129). If desired, custom Picture Controls can be saved to a memory card and copied to other Nikon 1 J1 cameras or loaded into compatible software (📖 130).

### Modified Picture Controls

Picture Controls that have been modified from default settings are indicated by asterisks ("\*") next to the Picture Control name and icon in the Picture Control menu (📖 125) and next to the Picture Control icon (📖 4) in the detailed display (📖 5).



## Picture Control Settings

Quick adjust	Choose from options between <b>-2</b> and <b>+2</b> to reduce or exaggerate the effect of the selected Picture Control (note that this resets all manual adjustments). For example, choosing positive values for <b>Vivid</b> makes pictures more vivid. Not available with <b>Neutral</b> , <b>Monochrome</b> , or custom Picture Controls.	
Manual adjustments (all Picture Controls)	Sharpening	Control the sharpness of outlines. Select <b>A</b> to adjust sharpening automatically according to the type of scene, or choose from values between <b>0</b> (no sharpening) and <b>9</b> (the higher the value, the greater the sharpening).
	Contrast	Select <b>A</b> to adjust contrast automatically according to the type of scene, or choose from values between <b>-3</b> and <b>+3</b> (lower values prevent highlights in portrait subjects from being “washed out” in direct sunlight, while higher values preserve detail in misty landscapes and other low-contrast subjects).*
	Brightness	Choose <b>-1</b> for reduced brightness, <b>+1</b> for enhanced brightness. Does not affect exposure.*
Manual adjustments (non-monochrome only)	Saturation	Control the vividness of colors. Select <b>A</b> to adjust saturation automatically according to the type of scene, or choose from values between <b>-3</b> and <b>+3</b> (lower values reduce saturation and higher values increase it).
	Hue	Choose negative values (to a minimum of <b>-3</b> ) to make reds more purple, blues more green, and greens more yellow, positive values (up to <b>+3</b> ) to make reds more orange, greens more blue, and blues more purple.
Manual adjustments (monochrome only)	Filter effects	Simulate the effect of color filters on monochrome photographs. Choose from <b>Off</b> , yellow, orange, red, and green (☐ 128).
	Toning	Choose the tint used in monochrome photographs from <b>B&amp;W</b> (black-and-white), <b>Sepia</b> , <b>Cyanotype</b> (blue-tinted monochrome), <b>Red</b> , <b>Yellow</b> , <b>Green</b> , <b>Blue Green</b> , <b>Blue</b> , <b>Purple Blue</b> , and <b>Red Purple</b> (☐ 128).



\* Not available if Active D-Lighting (☐ 132) is on; reset if Active D-Lighting is activated after value is changed.



## ✔ "A" (Auto)

Results for auto sharpening, contrast, and saturation vary with exposure and the position of the subject in the frame.

## ✔ The Picture Control Grid

Pressing  up in Step 2 displays a Picture Control grid showing the contrast and saturation for the selected Picture Control in relation to the other Picture Controls (only contrast is displayed when **Monochrome** is selected). Release the  control to return to the Picture Control menu.

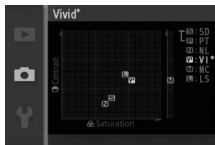

The icons for Picture Controls that use auto contrast and saturation are displayed in green in the Picture Control grid, and lines appear parallel to the axes of the grid.



## ✔ Previous Settings

The line under the value display in the Picture Control setting menu indicates the previous value for the setting. Use this as a reference when adjusting settings.

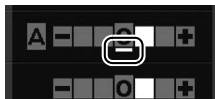



## ✔ Filter Effects (Monochrome Only)

The options in this menu simulate the effect of color filters on monochrome photographs. The following filter effects are available:

Y (yellow)	Enhance contrast. Can be used to reduce the brightness of the sky in landscape photographs. Orange produces more contrast than yellow, red more contrast than orange.
O (orange)	
R (red)	
G (green)	Softens skin tones. Can be used for portraits.

Note that the effects achieved with **Filter effects** are more pronounced than those produced by physical glass filters.

## ✔ Toning (Monochrome Only)

Pressing  when **Toning** is highlighted displays saturation options. Press  or  to adjust saturation. Saturation control is not available when **B&W** (black-and-white) is selected.



## Custom Picture Control

The Picture Controls supplied with the camera can be modified and saved as custom Picture Controls.

### *Edit/Save*

To create a custom Picture Control, select **Edit/save** and follow the steps below.

#### 1 Select a Picture Control.

Highlight an existing Picture Control and press **▶**, or press **OK** to proceed to Step 3 to save a copy of the highlighted Picture Control without further modification.



#### 2 Edit the selected Picture Control.

See page 127 for more information. To abandon any changes and start over from default settings, press the **Trash** button. Press **OK** when settings are complete.



#### 3 Save the Picture Control.

Highlight a destination (C-1 through C-9) and press **OK** to save the custom Picture Control and return to the shooting menu.

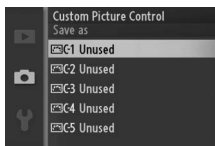

The new Picture Control will be listed in the **Picture Control** menu.

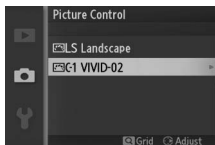

## Load from/Save to Card

Custom Picture Controls created using the Picture Control Utility available with ViewNX 2 or optional software such as Capture NX 2 can be copied to a memory card and loaded into the camera, or custom Picture Controls created with the camera can be copied to the memory card to be used in other Nikon 1 J1 cameras and compatible software and then deleted when no longer needed.

To copy custom Picture Controls to or from the memory card, or to delete custom Picture Controls from the memory card, select **Load from/save to card** in the **Custom Picture Control** menu. The following options will be displayed:

<b>Copy to camera</b>	Copy custom Picture Controls from the memory card to custom Picture Controls C-1 through C-9.
<b>Delete from card</b>	Delete selected custom Picture Controls from the memory card. The confirmation dialog shown at right will be displayed before a Picture Control is deleted; to delete the selected Picture Control, highlight <b>Yes</b> and press <b>OK</b> .
<b>Copy to card</b>	Copy a custom Picture Control (C-1 through C-9) to a selected destination (1 through 99) on the memory card.



### Copy to Card

Up to 99 custom Picture Controls can be stored on the memory card at any one time. The memory card can only be used to store user-created custom Picture Controls. The preset Picture Controls supplied with the camera can not be copied to the memory card or deleted.

### Custom Picture Control > Delete

The **Delete** option in the **Custom Picture Control** menu can be used to delete selected custom Picture Controls when they are no longer needed.

## Color Space

The color space determines the gamut of colors available for color reproduction. Choose **sRGB** for photos that will be used “as is,” with no further modification, **Adobe RGB** for photos that will be extensively processed or retouched after leaving the camera. Note that regardless of the option selected, sRGB is used for movies and Motion Snapshots and for photos recorded in movie mode.

### Color Space

Color spaces define the correspondence between colors and the numeric values by which they are represented in a digital image file. The sRGB color space is widely used, while Adobe RGB is typically used in publishing and commercial printing. sRGB is recommended when taking photographs that will be printed without modification or viewed in applications that do not support color management, or when taking photographs that will be printed with ExifPrint, the direct printing option on some household printers, or kiosk printing or other commercial print services. Adobe RGB photographs can also be printed using these options, but colors will not be as vivid.

JPEG photographs taken in the Adobe RGB color space are DCF compliant; applications and printers that support DCF will select the correct color space automatically. If the application or device does not support DCF, select the appropriate color space manually. For more information, see the documentation provided with the application or device.

### Nikon Software

ViewNX 2 (supplied) and Capture NX 2 (available separately) automatically select the correct color space when opening photographs created with this camera.



## Active D-Lighting

Active D-Lighting preserves details in highlights and shadows for natural contrast. Use with high contrast scenes such as a brightly lit outdoor view framed in a door or window or a subjects in the shade on a sunny day. It is most effective when used with **Matrix** metering (☞ 117).



Active D-Lighting: **Off**



Active D-Lighting: **☑ On**

### ☑ Active D-Lighting

Noise (randomly-spaced bright pixels, fog, or lines) may appear in photographs taken with Active D-Lighting. Uneven shading may be visible with some subjects.

### ✍ “Active D-Lighting” Versus “D-Lighting”

The **Active D-Lighting** option in the shooting menu is used to adjust exposure during shooting to optimize the dynamic range, while the **D-Lighting** option in the playback menu (☞ 97) is used to optimize dynamic range in images after shooting.





## Long Exposure NR



Photographs taken at slow shutter speeds are automatically processed to reduce “noise” (bright spots, randomly-spaced bright pixels, or fog), slightly increasing recording times. Selecting **On** increases the amount of noise reduction performed at shutter speeds slower than 1 s and increases the time required to record images by roughly 1.5 to 2 times. During processing, a warning will be displayed and pictures can not be taken (if the camera is turned off before processing is complete, the picture will be saved but noise reduction will not be performed). In continuous release mode, frame rates will slow and while photographs are being processed, the capacity of the memory buffer will drop.

## High ISO Noise Reduction

Select **On** to reduce “noise” (randomly-spaced bright pixels, lines, or fog). If **Off** is selected, noise reduction will only be performed at high ISO sensitivities; the amount of noise reduction is less than that performed when **On** is selected.

## Fade in/Fade Out

Add fade in and fade out effects at the beginning and end of HD movies shot with the camera.

 <b>W Fade (white)</b>	The movie fades in from white and fades out to white.
 <b>B Fade (black)</b>	The movie fades in from black and fades out to black.
<b>OFF None</b>	Fade in and fade out effects are not added to movies.



## Movie Sound Options

Adjust movie sound recording settings for the built-in microphone.

### ■ Microphone

Select **Microphone off** to disable sound recording. Selecting any other option enables recording and sets the microphone to the selected sensitivity.

#### The Icon

Movies recorded with the microphone off are indicated by a  icon in full-frame and movie playback.

### ■ Wind Noise Reduction

Select **On** to enable the low-cut filter, reducing noise produced by wind blowing over the microphone (note that other sounds may also be affected).



## Interval Timer Shooting

Take photographs automatically at preset intervals.

### ✔ Before Shooting

Before proceeding, check that the clock is set correctly (📅 18, 154) and then take a test shot at current settings and view the results in the monitor.

Use of a tripod is recommended. To ensure that shooting is not interrupted, be sure the battery is fully charged or use an optional EH-5b AC adapter and EP-5C power connector.

### 1 Select Interval/Number of shots.

Highlight **Interval/Number of shots** and press ► to display interval timer options.

### 2 Adjust settings.

Press ◀ or ▶ to highlight hours, minutes, or seconds and press ▲ or ▼ to choose an interval longer than the slowest anticipated shutter speed, then highlight the number of intervals and press ▲ or ▼ to change. Press Ⓞ to return to the interval timer shooting menu when settings are complete.

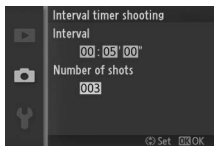

### 3 Start shooting.

Highlight **Start** and press Ⓞ. Shooting will start after about 3 s, and continue at the selected interval until all the shots have been taken (one shot is taken at each interval). Note that the pause following the recording of each shot varies with shutter speed and the time needed to record the image, with the result that photographs may not be recorded at the selected interval. Photos may also not be recorded if the shutter can not be released (for example, because the camera is unable to focus).

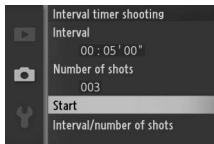

### Interval Timer Photography

A warning will be displayed if the camera is unable to start interval timer photography at current settings (for example, when “Bulb” is selected for shutter speed). While interval timer photography is in progress, settings can not be adjusted and the camera will not turn off automatically (□ 17).

### Interrupting Interval Timer Photography

Interval timer shooting ends and interval timer settings are reset when the camera is turned off, the battery is exhausted, the memory card is full, the mode dial is rotated to a new setting, or the MENU or  button is pressed.

## Vibration Reduction



This option is available with lenses that supports vibration reduction (VR). The options available vary with the type of lens: **Normal/Active/Off** for lenses that support active vibration reduction and **On/Off** for other VR lenses. Choose **Active, Normal**, or **On** to reduce the effects of vibration; choose **Active** when shooting from a moving vehicle or while walking or for other forms of strong camera shake, **Normal** for the relatively mild camera shake that occurs while standing still.

### Vibration Reduction

When the camera is panned, vibration reduction applies only to motion that is not part of the pan (if the camera is panned horizontally, for example, vibration reduction will be applied only to vertical shake), making it much easier to pan the camera smoothly in a wide arc. The composition may appear to change after the shutter is released, but this does not indicate a malfunction.



## Focus Mode

Choose how the camera focuses (note that focus mode selection is not available in  **Scene auto selector** mode;  21, 106).

<b>AF-A</b>	<b>Auto-select AF:</b> The camera automatically selects AF-S if the subject is stationary, AF-C if it is moving.*
<b>AF-S</b>	<b>Single AF:</b> For stationary subjects. Focus locks when the shutter-release button is pressed halfway.*
<b>AF-C</b>	<b>Continuous AF:</b> For subjects in motion. The camera focuses continuously while the shutter-release button is pressed halfway. Photos can be taken whether or not the camera is in focus.
<b>AF-F</b>	<b>Full-time AF:</b> For subjects in motion. The camera focuses continuously; photos can be taken whether or not the camera is in focus.
<b>MF</b>	<b>Manual focus:</b> Focus manually (  140). Photos can be taken whether or not the camera is in focus.

\*Shutter can only be released if camera is able to focus.

### Focus Mode

The options available vary with the shooting mode.

<b>Still image mode</b>	AF-A (default), AF-S, AF-C, MF	
<b>Movie mode</b>	<b>HD movie</b>	AF-F (default), AF-S, MF
	<b>Slow motion</b>	AF-S (default), MF
<b>Smart Photo Selector</b>	AF-A	
<b>Motion Snapshot</b>	AF-S	



### **The AF-Assist Illuminator**

If the subject is poorly lit, the AF-assist illuminator will light automatically to assist the autofocus operation when the shutter-release button is pressed halfway. The AF-assist illuminator is available in still image, Smart Photo Selector, and Motion Snapshot modes and lights only if:

- **AF-S** is selected for focus mode or single AF selected in **AF-A** focus mode,
- **Auto-area** is selected for **AF-area mode** (☞ 142) or the center focus area (☞ 23) is selected for **Single-point**, and
- **On** is selected for **Built-in AF assist** in the shooting menu (☞ 145).

Larger lenses may prevent the illuminator lighting all or part of the subject. Remove lens hoods when using the illuminator.

### **See Also**

See page 151 for information on controlling the beep that sounds when the camera focuses.

*AF-assist illuminator*

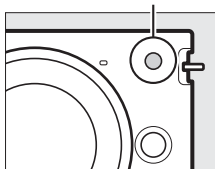

## Getting Good Results with Autofocus

Autofocus does not perform well under the conditions listed below. The shutter release may be disabled if the camera is unable to focus under these conditions, or the focus area may be displayed in green and the camera may sound a beep, allowing the shutter to be released even when the subject is not in focus. In these cases, focus manually (📖 140) or use focus lock (📖 143) to focus on another subject at the same distance, and then recompose the photograph.

*There is little or no contrast between the subject and the background.*

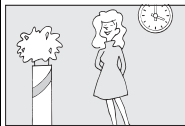

**Example:** The subject is the same color as the background.

*The subject contains areas of sharply contrasting brightness.*

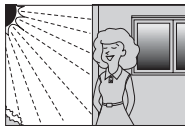

**Examples:** The subject is half in the shade; a night scene with point illumination.

*The subject contains objects at different distances from the camera.*



**Example:** The subject is inside a cage.

*Background objects appear larger than the subject.*



**Example:** A building is in the frame behind the subject.

*The subject is dominated by regular geometric patterns.*

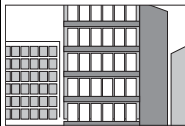

**Example:** Blinds or a row of windows in a skyscraper.

*The subject contains many fine details or is made up of objects that are small or lack variation in brightness.*

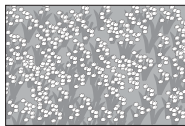

**Example:** A field of flowers.



## Manual Focus

Manual focus can be used when autofocus does not produce the desired results.

### 1 Highlight Manual focus.

Press ▲ or ▼ to highlight **Manual focus** (📖 137).

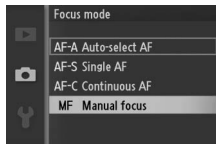

### 2 Display the manual focus guides.







Press **OK** to magnify the view at the center of the frame and display manual focus guides.







### 3 Focus.

Rotate the multi selector until the subject is in focus. Rotate the multi selector clockwise to increase the focus distance, counterclockwise to decrease; the faster you rotate the multi selector, the quicker the focus distance changes. The focus indicator shows the approximate focus distance. Press  when the subject is in focus.

To magnify the view in the display by up to about 10× for precise focus, press the  control up. Press , , , or  to view areas of the frame not currently visible in the display; the visible portion is shown by the navigation window. To zoom out, press the  control down.

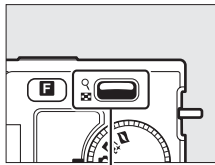
**Multi selector dial:** Focus



 **control:** Zoom in or out

**Focus indicator**

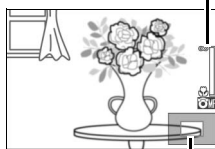

**Navigation window**

#### Movies

The multi selector can also be used to choose the focus distance if manual focus is selected during movie recording. Rotate the multi selector clockwise to increase the focus distance, counterclockwise to decrease; the faster you rotate the multi selector, the quicker the focus distance changes.

#### Focal Plane Position

To determine the distance between your subject and the camera, measure from the focal plane mark on the camera body. The distance between the lens mounting flange and the focal plane is approximately 17 mm (0.7 in.).

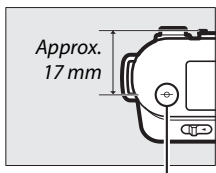









**Focal plane mark**

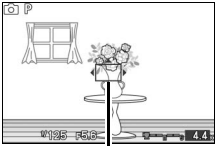

## AF-Area Mode

Choose how the focus area for autofocus is selected.

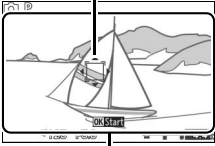
 <b>Auto-area</b>	The camera automatically detects the subject and selects the focus area.
 <b>Single-point</b>	<p>Press  to view the focus area selection display, then use the multi selector to position the focus area over your subject and press ; the camera focuses on the subject in the selected focus area only. Use with stationary subjects.</p>  <p><i>Focus area</i></p>
 <b>Subject tracking</b>	<p>Press  to view the focus area selection display, then use the multi selector to position the focus area over your subject and press . The focus area will track the subject as it moves through the area shown at right. The camera will focus on the selected subject when the shutter-release button is pressed halfway. To end focus tracking when shooting is complete, press .</p>  <p><i>Subject tracking area</i></p>

### Subject Tracking

The camera may be unable to track subjects if they move quickly, leave the frame or are obscured by other objects, change visibly in size, color, or brightness, or are too small, too large, too bright, too dark, or similar in color or brightness to the background.



## Focus Lock

Focus lock can be used to change the composition after focusing on the subject in the center of the frame, allowing you to focus on a subject that will not be in the center of the final composition. If the camera is unable to focus using autofocus (📖 139), you can also focus on another subject at the same distance and then use focus lock to recompose the photograph. Focus lock is most effective when an option other than **Auto-area** is selected for **AF-area mode** (📖 142).

### 1 Focus.

Position the subject in the center of the frame and press the shutter-release button halfway to initiate focus. Check that the focus area is displayed in green. If **AF-S** is selected for focus mode (📖 137), focus will lock while the shutter-release button is pressed halfway.

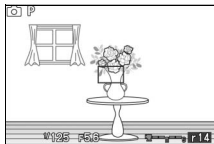

## 2 Lock focus.

With the shutter-release button pressed halfway, press ▲ (AE-L) to lock both focus and exposure (an AE-L indicator will be displayed; □ 118). Focus will remain locked while ▲ (AE-L) is pressed, even if you later remove your finger from the shutter-release button.

### See Also

For information on changing the role of the ▲ (AE-L) button, see page 152.

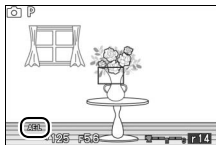

## 3 Recompose the photograph and shoot.

Focus will remain locked between shots if you keep ▲ (AE-L) pressed, allowing several photographs in succession to be taken at the same focus setting.

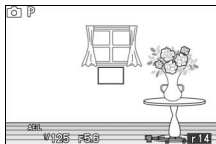

Do not change the distance between the camera and the subject while focus lock is in effect. If the subject moves, focus again at the new distance.



## Face-Priority AF

Choose **On** to enable face-priority AF (📖 23).

## Built-in AF Assist

If **On** is selected, the built-in AF-assist illuminator will light to illuminate poorly-lit subjects in still image, Smart Photo Selector, or Motion Snapshot mode if:

- **AF-S** is selected for focus mode (📖 137) or single AF is selected in **AF-A**, and
- **Auto-area** is selected for **AF-area mode** (📖 142) or the center focus area is selected for **Single-point**.

*AF-assist illuminator*

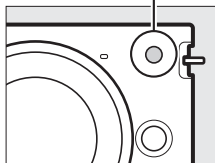

If **Off** is selected, the AF-assist illuminator will not light to assist the focus operation. Autofocus may not produce the desired results when lighting is poor.

### See Also

See page 138 for information on using the AF-assist illuminator. Information on the modes in which AF-assist is available may be found on page 49.



## Flash Compensation

Flash compensation alters flash output from the level suggested by the camera, changing the brightness of the main subject relative to the background. Choose from values between  $-3$  EV (darker) and  $+1$  EV (brighter) in increments of  $\frac{1}{3}$  EV; in general, positive values make the subject brighter while negative values make it darker.

A  icon is displayed when flash compensation is in effect. Normal flash output can be restored by setting flash compensation to  $\pm 0$ . Flash compensation is not reset when the camera is turned off.

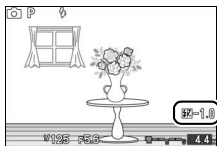



# The Setup Menu

To display the setup menu, press MENU and select the setup menu tab (Y).





MENU button

The setup menu contains the following options:

Option	Description	Default	
<b>Reset setup options</b>	Reset setup menu options to default values.	—	149
<b>Format memory card</b>	Format the memory card.	—	149
<b>Slot empty release lock</b>	Allow the shutter to be released when no memory card is inserted in the camera.	Release locked	149
<b>Welcome screen</b>	Display a welcome message at startup.	Off	150
<b>Monitor brightness</b>	Adjust monitor brightness.	0	150
<b>Grid display</b>	Display a framing grid.	Off	150
<b>Sound settings</b>	Choose the sounds made during shooting.	Autofocus/self-timer: On Shutter: On	151



Option	Description	Default	
<b>Auto power off</b>	Choose the auto power off delay.	30 s	151
<b>Remote on duration</b>	Choose how long the camera waits for a signal from a remote control.	5 min	152
<b>Assign AE/AF-L button</b>	Choose the role played by the  button.	AE/AF lock	152
<b>Shutter button AE lock</b>	Choose whether exposure locks when the shutter-release button is pressed halfway.	Off	152
<b>HDMI device control</b>	Choose whether remote controls for HDMI-CEC devices to which the camera is connected can be used to operate the camera.	On	85
<b>Flicker reduction</b>	Reduce flicker or banding.	—	153
<b>Reset file numbering</b>	Reset file numbering.	—	153
<b>Time zone and date</b>	Set the camera clock.	Daylight saving time: Off	154
<b>Language</b>	Choose a language for the camera displays.	—	154
<b>Auto image rotation</b>	Record camera orientation with pictures.	On	155
<b>Firmware version</b>	Display the current firmware version.	—	155





## Reset Setup Options

Select **Yes** to reset all setup menu options other than **Flicker reduction**, **Time zone and date** and **Language** to default values.

## Format Memory Card

Select **Yes** to format the memory card. *Note that this permanently deletes all data on the card, including protected images; before proceeding, be sure to copy important pictures and other data to a computer (📖 79).* To exit without formatting the memory card, highlight **No** and press **OK**.

The message shown at right is displayed while the card is formatted; *do not remove the memory card or remove or disconnect the power source until formatting is complete.*

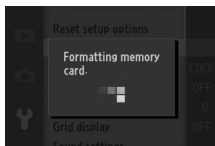

## Slot Empty Release Lock

If **Enable release** is selected, the shutter can be released when no memory card is inserted. No pictures will be recorded, although they will be displayed in demo mode. Select **Release locked** to enable the shutter only when a card is inserted.



## Welcome Screen

If **On** is selected, the message at right will be displayed whenever the camera is turned on.



## Monitor Brightness

Highlight **Monitor brightness** and press ►. Brightness can then be adjusted by pressing ▲ or ▼; choose higher values for increased brightness, lower values for reduced brightness.

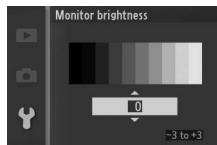

## Grid Display

Select **On** to display a framing grid (📖 5).



## Sound Settings

Highlight items and press ► to select or deselect. If **Autofocus/self-timer** is selected, a beep will sound when the camera focuses and during self-timer and remote control photography; to mute the beep, remove the check from this item.

Select **Shutter** to play a sound when the shutter is released, or remove the check from this item to mute the shutter. Press Ⓞ to exit when settings are complete.

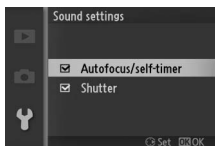

## Auto Power Off

Choose how long the displays remain on when no operations are performed (17). Choose shorter delays to reduce the drain on the battery. Once the displays have turned off, they can be reactivated by operating the camera buttons or mode dial.

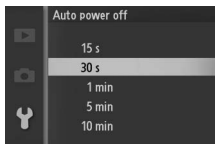

## Remote on Duration

Choose how long the camera will remain active while waiting for a signal from the remote control (📖 53). Choose shorter delays to reduce the drain on the battery. Note that remote control mode must be reselected once the timer has expired.

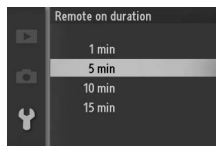

## Assign AE/AF-L Button

Choose whether the  $\blacktriangle$  (AE-L/AF-L) button locks both focus and exposure (**AE/AF lock**), exposure only (**AE lock only**), or focus only (**AF lock only**). Focus lock is described on page 143, exposure lock on page 118.



## Shutter Button AE Lock

If **On** is selected, exposure will lock while the shutter-release button is pressed halfway.

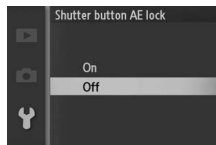

## Flicker Reduction

Reduce flicker and banding in the displays and in movies while shooting under fluorescent or mercury-vapor lighting. Choose a frequency which matches that of the local AC power supply.

### Flicker Reduction

If you are unsure as to the frequency of the local power supply, test both options and choose the one that produces the best results. Flicker reduction may not produce the desired results if the subject is very bright, in which case you should select **A Aperture-priority auto** or **M Manual** for **Exposure mode** and choose a smaller aperture (larger f-number).

## Reset File Numbering

When a photograph is taken or a movie is recorded, the camera names the file by adding one to the number of the previous file (📖 115). If the current folder is numbered 999 and contains either 999 photographs or a photograph numbered 9999, the shutter-release button will be disabled and no further photographs can be taken. To reset file numbering to 0001, select **Yes** for **Reset file numbering** and then either format the current memory card or insert a new memory card.

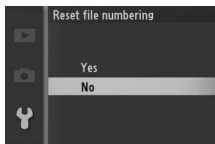

## Time Zone and Date

Change time zones, set the camera clock, choose the date display order, or turn daylight saving time on or off (📖 18).

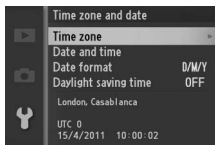

<b>Time zone</b>	Choose a time zone. The camera clock is automatically set to the time in the new time zone.
<b>Date and time</b>	Set the camera clock.
<b>Date format</b>	Choose the order in which the day, month, and year are displayed.
<b>Daylight saving time</b>	Turn daylight saving time on or off. The camera clock will automatically be advanced or set back one hour. The default setting is <b>Off</b> .

## Language

Choose a language for camera messages and displays.

Čeština	Czech	Português	Portuguese
Dansk	Danish	Русский	Russian
Deutsch	German	Română	Romanian
English	English	Suomi	Finnish
Español	Spanish	Svenska	Swedish
Ελληνικά	Greek	Türkçe	Turkish
Français	French	Українська	Ukrainian
Indonesia	Indonesian	عربي	Arabic
Italiano	Italian	简体中文	Simplified Chinese
Magyar	Hungarian	繁體中文	Traditional Chinese
Nederlands	Dutch	日本語	Japanese
Norsk	Norwegian	한글	Korean
Polski	Polish	ภาษาไทย	Thai

## Auto Image Rotation

Photographs taken while **On** is selected contain information on camera orientation, allowing them to be rotated automatically during playback or when viewed in ViewNX 2 or Capture NX 2 (available separately;  158). The following orientations are recorded:

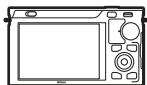

*Landscape (wide)  
orientation*



*Camera rotated 90°  
clockwise*



*Camera rotated 90°  
counterclockwise*

Camera orientation is not recorded when **Off** is selected. Choose this option when panning or taking photographs with the lens pointing up or down.

### **Auto Image Rotation**

Image orientation is not recorded in movie or Motion Snapshot modes.

### **Rotate Tall**

To automatically rotate “tall” (portrait-orientation) photographs for display during playback, select **On** for the **Rotate tall** option in the playback menu ( 96).

## Firmware Version

View the current firmware version.









# Technical Notes

Read this chapter for information on compatible accessories, cleaning and storing the camera, and what to do if an error message is displayed or you encounter problems using the camera.

## Optional Accessories

At the time of writing, the following accessories were available for your camera.

<b>Lenses</b>	<b>1 mount lenses</b>
	<b> Lens f-number</b>
	The f-number given in lens names is the maximum aperture of the lens.

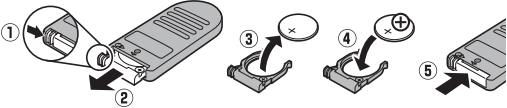

<b>Power sources</b>	<ul style="list-style-type: none"> <li>• <b>Rechargeable Li-ion Battery EN-EL20</b> (☐ 11–13): Additional EN-EL20 batteries are available from local retailers and Nikon-authorized service representatives.</li> <li>• <b>Battery Charger MH-27</b> (☐ 11): Recharge EN-EL20 batteries.</li> <li>• <b>Power Connector EP-5C, AC Adapter EH-5b</b>: These accessories can be used to power the camera for extended periods (EH-5a and EH-5 AC adapters can also be used). An EP-5C power connector is required to connect the camera to the EH-5b, EH-5a, or EH-5; see page 161 for details.</li> </ul>
<b>Remote controls</b>	<p><b>Wireless Remote Control ML-L3</b> (☐ 53): The ML-L3 uses a 3 V CR2025 battery.</p>  <p>Pressing the battery-chamber latch to the right (①), insert a fingernail into the gap and open the battery chamber (②). Ensure that the battery is in the correct orientation (④).</p>
<b>Software</b>	<p><b>Capture NX 2</b>: A complete photo editing package offering such features as white balance adjustment and color control points.</p> <p><b>Note:</b> Use the latest versions of Nikon software; see the web-sites listed on page xvii for the latest information on supported operating systems. At default settings, Nikon Message Center 2 will periodically check for updates to Capture NX 2 and other Nikon software and firmware while you are logged in to an account on the computer and the computer is connected to the Internet. A message is automatically displayed when an update is found.</p>

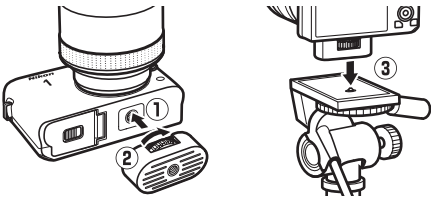

<b>Body caps</b>	<b>Body Cap BF-N1000:</b> The body cap keeps the dust shield free of dust when a lens is not in place.
<b>Tripod adapters</b>	<p><b>Tripod Adapter TA-N100:</b> Prevents large lenses from coming into contact with the tripod head when the camera is mounted on a tripod.</p> <p><b>Attaching the TA-N100</b></p>  <p><b>1</b> Attach the TA-N100 to the camera. After turning the camera off, insert the TA-N100 in the camera tripod mount (①) and rotate the screw in the direction shown (②) to fasten the TA-N100 to the camera.</p> <p><b>2</b> Attach a tripod. Attach a tripod (available separately from third-party suppliers) to the TA-N100 (③). Hold the camera while fastening the tripod to ensure that the tripod is securely attached.</p>



## Approved Memory Cards

The following cards have been tested and approved for use in the camera. Cards with class 6 or faster write speeds are recommended for movie recording. Recording may end unexpectedly when cards with slower write speeds are used.

	SD cards	SDHC cards <sup>2</sup>	SDXC cards <sup>3</sup>
SanDisk	2 GB <sup>1</sup>	4 GB, 8 GB, 16 GB, 32 GB	64 GB
Toshiba			
Panasonic			48 GB, 64 GB
Lexar Media	—	4 GB, 8 GB, 16 GB	—
Platinum II		4 GB, 8 GB, 16 GB, 32 GB	
Professional		4 GB, 8 GB, 16 GB	
Full-HD Video		4 GB, 8 GB, 16 GB	

- 1 Check that any card readers or other devices with which the card will be used support 2 GB cards.
- 2 Check that any card readers or other devices with which the card will be used are SDHC-compliant. The camera supports UHS-1.
- 3 Check that any card readers or other devices with which the card will be used are SDXC-compliant.  The camera supports UHS-1.

Other cards have not been tested. For more details on the above cards, please contact the manufacturer.



## Attaching a Power Connector and AC Adapter

Turn the camera off before attaching an optional power connector and AC adapter.

### 1 Ready the camera.

Open the battery-chamber (①) and power connector (②) covers.

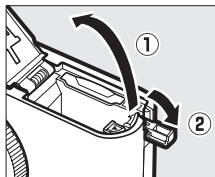

### 2 Insert the EP-5C power connector.

Be sure to insert the connector in the orientation shown, using the connector to keep the orange battery latch pressed to one side. The latch locks the connector in place when the connector is fully inserted.

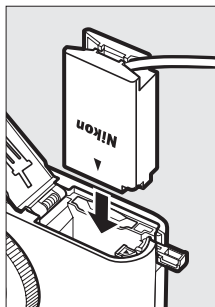

### 3 Close the battery-chamber cover.

Position the power connector cable so that it passes through the power connector slot and close the battery-chamber cover.

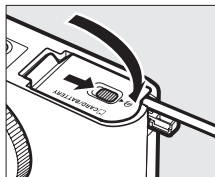

#### 4 Connect the AC adapter.

Connect the AC adapter power cable to the AC socket on AC adapter (③) and the EP-5C power cable to the DC socket (④). A  icon is displayed in the monitor when the camera is powered by the AC adapter and power connector.

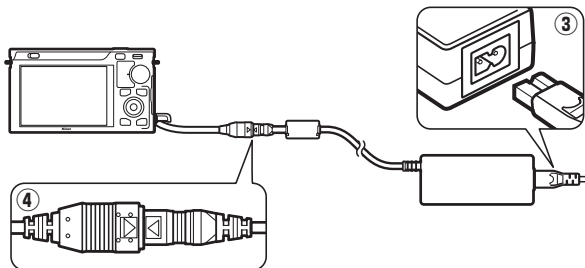

## Storage and Cleaning

### Storage

If the camera will not be used for an extended period, remove the battery and store it in a cool, dry area with the terminal cover in place. To prevent mold or mildew, store the camera in a dry, well-ventilated area. Do not store your camera with naphtha or camphor moth balls or in locations that:

- are poorly ventilated or subject to humidities of over 60%
- are next to equipment that produces strong electromagnetic fields, such as televisions or radios
- are exposed to temperatures above 50 °C (122 °F) or below –10 °C (14 °F)

### Cleaning

<b>Camera body</b>	Use a blower to remove dust and lint, then wipe gently with a soft, dry cloth. After using the camera at the beach or sea-side, wipe off sand or salt with a cloth lightly dampened in distilled water and dry thoroughly. <b>Important:</b> <i>Dust or other foreign matter inside the camera may cause damage not covered under warranty.</i>
<b>Lens</b>	Lenses are easily damaged. Remove dust and lint with a blower. If using an aerosol blower, keep the can vertical to prevent the discharge of liquid. To remove fingerprints and other stains, apply a small amount of lens cleaner to a soft cloth and clean with care.
<b>Monitor</b>	Remove dust and lint with a blower. When removing fingerprints and other stains, wipe the surface lightly with a soft cloth or chamois leather. Do not apply pressure, as this could result in damage or malfunction.
<b>Dust shield</b>	The dust shield is easily damaged. Remove dust and lint with a blower.

*Do not use alcohol, thinner, or other volatile chemicals.*



## Caring for the Camera and Battery: Cautions

**Do not drop:** The product may malfunction if subjected to strong shocks or vibration.

**Keep dry:** This product is not waterproof, and may malfunction if immersed in water or exposed to high levels of humidity. Rusting of the internal mechanism can cause irreparable damage.

**Avoid sudden changes in temperature:** Sudden changes in temperature, such as those that occur when entering or leaving a heated building on a cold day, can cause condensation inside the device. To prevent condensation, place the device in a carrying case or plastic bag before exposing it to sudden changes in temperature.

**Keep away from strong magnetic fields:** Do not use or store this device in the vicinity of equipment that generates strong electromagnetic radiation or magnetic fields. Strong static charges or the magnetic fields produced by equipment such as radio transmitters could interfere with the displays, damage data stored on the memory card, or affect the product's internal circuitry.

**Do not leave the lens pointed at the sun:** Do not leave the lens pointed at the sun or other strong light source for an extended period. Intense light may cause the image sensor to deteriorate or produce a white blur effect in photographs.

**Keep the lens mount covered:** Be sure to attach the body cap if the camera is without a lens.

**Do not touch the dust shield:** The dust shield covering the image sensor is easily damaged. Under no circumstances should you exert pressure on the shield or poke it with cleaning tools. These actions could scratch or otherwise damage the shield.

**Turn the product off before removing or disconnecting the power source:** Do not unplug the product or remove the battery while the product is on or while images are being recorded or deleted. Forcibly cutting power in these circumstances could result in loss of data or in damage to product memory or internal circuitry. To prevent an accidental interruption of power, avoid carrying the product from one location to another while the AC adapter is connected.





**Cleaning:** When cleaning the camera body, use a blower to gently remove dust and lint, then wipe gently with a soft, dry cloth. After using the camera at the beach or seaside, wipe off any sand or salt using a cloth lightly dampened in pure water and then dry the camera thoroughly.

Lenses are easily damaged. Dust and lint should be gently removed with a blower. When using an aerosol blower, keep the can vertical to prevent discharge of liquid. To remove fingerprints and other stains, apply a small amount of lens cleaner to a soft cloth and wipe the lens carefully.

**Storage:** To prevent mold or mildew, store the camera in a dry, well-ventilated area. If you are using an AC adapter, unplug the adapter to prevent fire. If the product will not be used for an extended period, remove the battery to prevent leakage and store the camera in a plastic bag containing a desiccant. Do not, however, store the camera case in a plastic bag, as this may cause the material to deteriorate. Note that desiccant gradually loses its capacity to absorb moisture and should be replaced at regular intervals.

To prevent mold or mildew, take the camera out of storage at least once a month. Turn the camera on and release the shutter a few times before putting it away.

Store the battery in a cool, dry place. Replace the terminal cover before putting the battery away.

**Notes on the monitor:** This display may contain a few pixels that are always lit or that do not light. This is common to all TFT LCD displays and does not indicate a malfunction. Images recorded with the product are unaffected.

Images in the monitor may be difficult to see in a bright light.

Do not apply pressure to the display, as this could cause damage or malfunction. Dust or lint on the displays can be removed with a blower. Stains can be removed by wiping lightly with a soft cloth or chamois leather. Should the monitor break, care should be taken to avoid injury from broken glass and to prevent liquid crystal from the display touching the skin or entering the eyes and mouth.



**Moiré:** Moiré is an interference pattern created by the interaction of an image containing a regular, repeating grid, such as the pattern of weave in cloth or windows in a building, with the camera image sensor grid. In some cases, it may appear in the form of lines. If you notice moiré in your photographs, try changing the distance to the subject, zooming in and out, or changing the angle between the subject and the camera.

**Lines:** Noise in the form of lines may in rare cases appear in pictures of extremely bright or backlit subjects.

**Batteries:** Batteries may leak or explode if improperly handled. Observe the following precautions when handling batteries:

- Use only batteries approved for use in this equipment.
- Do not expose the battery to flame or excessive heat.
- Keep the battery terminals clean.
- Turn the product off before replacing the battery.
- Remove the battery from the camera or charger when not in use and replace the terminal cover. These devices draw minute amounts of charge even when off and could draw the battery down to the point that it will no longer function. If the battery will not be used for some time, insert it in the camera and run it flat before removing it and storing it in a location with an ambient temperature of 15 to 25 °C (59 to 77 °F; avoid hot or extremely cold locations). Repeat this process at least once every six months.
- Turning the camera on and off repeatedly when the battery is fully discharged will shorten battery life. Batteries that have been fully discharged must be charged before use.
- The internal temperature of the battery may rise while the battery is in use. Attempting to charge the battery while the internal temperature is elevated will impair battery performance, and the battery may not charge or charge only partially. Wait for the battery to cool before charging.
- Continuing to charge the battery after it is fully charged can impair battery performance.



- A marked drop in the time a fully charged battery retains its charge when used at room temperature indicates that it requires replacement. Purchase a new EN-EL20 battery.
- Charge the battery before use. When taking photographs on important occasions, ready a spare EN-EL20 battery and keep it fully charged. Depending on your location, it may be difficult to purchase replacement batteries on short notice. Note that on cold days, the capacity of batteries tends to decrease. Be sure the battery is fully charged before taking photographs outside in cold weather. Keep a spare battery in a warm place and exchange the two as necessary. Once warmed, a cold battery may recover some of its charge.
- Used batteries are a valuable resource; recycle in accord with local regulations.

#### **Servicing the Camera and Accessories**

The camera is a precision device and requires regular servicing. Nikon recommends that the camera be inspected by the original retailer or Nikon-authorized service representative once every one to two years, and that it be serviced once every three to five years (note that fees apply to these services). Frequent inspection and servicing are particularly recommended if the camera is used professionally. Any accessories regularly used with the camera, such as lenses or optional flash units, should be included when the camera is inspected or serviced.



## Defaults

Defaults for the options in the playback, shooting, and setup menus may be found on pages 93, 103, and 147, respectively. Defaults for other settings are listed below.

Option	Default
Focus area (☞ 142)	Center*
Flexible program (☞ 108)	Off
Autoexposure lock (☞ 118)	Off
Focus lock (☞ 143)	Off
Self-timer (☞ 53)	Off
Exposure compensation (☞ 56)	0.0
Flash mode (☞ 58)	Fill flash
Movie mode (☞ 37)	HD movie
Theme (☞ 47)	Beauty
Picture Control settings (☞ 125)	Unmodified

\* Not displayed when **Auto-area** is selected for **AF-area mode**.



## Memory Card Capacity

The following table shows the number of pictures or amount of movie footage that can be stored on a 16 GB Toshiba R95 W80MB/s UHS-I SDHC card at different image quality, size, or movie settings. All figures are approximate; file size varies with the scene recorded.

### ■ Still Images (Still Image Mode)

Image quality (□ 114)	Image size (□ 114)	File size	No. of images	Buffer capacity <sup>1</sup>
NEF (RAW) + JPEG fine <sup>2</sup>	3872×2592	23.9 MB	659	19
	2896×1944	21.4 MB	736	19
	1936×1296	19.6 MB	804	19
NEF (RAW)	—	17.1 MB	922	19
JPEG fine	3872×2592	6.8 MB	2300	28
	2896×1944	4.3 MB	3600	34
	1936×1296	2.5 MB	6200	46
JPEG normal	3872×2592	3.4 MB	4500	38
	2896×1944	2.2 MB	7100	46
	1936×1296	1.3 MB	11900	65
JPEG basic	3872×2592	1.8 MB	8900	53
	2896×1944	1.1 MB	13900	65
	1936×1296	0.7 MB	22800	88

**1** Maximum number of pictures that can be stored in memory buffer at ISO 100. Drops if long exposure noise reduction is on (□ 133).

**2** Image size applies to JPEG images only. Size of NEF (RAW) images can not be changed. File size is the total for NEF (RAW) and JPEG images.

### ■ HD Movies

Movie settings (□ 116)	Maximum total length (approx.) <sup>*</sup>
1080/60i	1 hour 27 minutes
1080/30p	1 hour 27 minutes
720/60p	2 hours 10 minutes

<sup>\*</sup>For information on the maximum length that can be recorded in a single clip, see page 116.



## ■ Slow Motion Movies

Frame rate (□ 116)	Maximum total recorded length (approx.)*
400 fps	1 hour 27 minutes
1200 fps	1 hour 27 minutes

\* Up to five seconds of slow motion footage can be recorded in a single clip. Playback length is about 13.2 (**400 fps**) or 40 (**1200 fps**) times the recorded length.

## ■ Still Images (Smart Photo Selector Mode)

Image quality (□ 114)	Image size (□ 114)	File size <sup>1</sup>	No. of shots
NEF (RAW) + JPEG fine <sup>2</sup>	3872×2592	119.4 MB	131
	2896×1944	106.9 MB	147
	1936×1296	97.8 MB	160
NEF (RAW)	—	85.3 MB	184
JPEG fine	3872×2592	34.1 MB	461
	2896×1944	21.6 MB	729
	1936×1296	12.5 MB	1258
JPEG normal	3872×2592	17.2 MB	915
	2896×1944	10.9 MB	1438
	1936×1296	6.6 MB	2397
JPEG basic	3872×2592	8.8 MB	1798
	2896×1944	5.6 MB	2797
	1936×1296	3.4 MB	4577

**1** Total size of all five images recorded with each shot.

**2** Image size applies to JPEG images only. Size of NEF (RAW) images can not be changed. File size is the total for NEF (RAW) and JPEG images.

## ■ Still Images (Motion Snapshot Mode)

Image quality	Image size	File size*	No. of shots
—	—	17.7 MB	891

\* File size is the total for a single photograph and movie.



## Troubleshooting

If the camera fails to function as expected, check this list of common problems before consulting your retailer or Nikon representative.

### **Display**

---

#### **The monitor is off:**

- The camera is off (☐ 17) or the battery is exhausted (☐ 11, 20).
  - The monitor has turned off automatically to save power (☐ 151). The monitor can be reactivated by operating buttons or the mode dial.
  - The camera is connected to a computer (☐ 79) or television (☐ 84).
- 

#### **The monitor turns off without warning:**

- The battery is low (☐ 11, 20).
  - The monitor has turned off automatically to save power (☐ 151). The monitor can be reactivated by operating buttons or the mode dial.
  - The camera's internal temperature is high (☐ xvi, 179). Wait for the camera to cool before turning it on again.
- 

**Indicators are not displayed:** Press the DISP button (☐ 5).



## Shooting (All Exposure Modes)

---

**The camera takes time to turn on:** Delete files or format the memory card.

---

**The shutter-release is disabled:**

- The battery is exhausted (☐ 11, 20).
  - The memory card is locked (☐ 14) or full (☐ 13, 20).
  - The flash is charging (☐ 59).
  - The camera is not in focus (☐ 23).
  - You are currently filming a slow motion movie (☐ 39).
- 

**Continuous is selected in still image mode but only one picture is taken when the shutter-release button is pressed:** Continuous shooting is not available if the flash is raised in **Continuous** mode (☐ 26). Pictures can be taken in continuous mode if **Electronic (Hi)** is selected, but the flash will not fire.

---

**The camera does not focus automatically:**

- The subject is not suited to autofocus (☐ 139).
  - The camera is in manual focus mode (☐ 137, 140).
- 

**Focus does not lock when the shutter-release button is pressed halfway:** Use the ▲ (AF-ON) button to lock focus when **AF-C** is selected for focus mode or when photographing moving subjects in **AF-A** mode (☐ 137, 143).

---

**Focus area selection is unavailable:** Focus area selection is not available in auto-area (☐ 142) or face-priority (☐ 23) AF. In other AF-area modes, the focus area can be selected by pressing .

---

**Subject-tracking AF not available:** Select a non-monochrome Picture Control (☐ 125, 142).

---

**AF-area mode selection is unavailable:** The camera is in Smart Photo Selector mode (☐ 31), manual focus mode is selected (☐ 137), or  **Scene auto selector** is selected for **Exposure mode** (☐ 106).

---

**Image size selection is unavailable:** **NEF (RAW)** is selected for image quality (☐ 114).

---

**The camera is slow to record photos:** Turn long exposure noise reduction off (☐ 133).

---

**Noise (bright spots, randomly-spaced bright pixels, fog, or lines) appears in photos:**

- Lower ISO sensitivity or enable high ISO noise reduction (☐ 133).
  - Use long exposure noise reduction at shutter speeds slower than 1 s (☐ 133).
- 





---

**No photo taken when remote control shutter-release button is pressed:**

- Replace battery in remote control (□ 158).
- Choose a remote control mode (□ 53).
- The remote control standby timer has expired (□ 152).
- The remote is not pointed at the camera or the infrared receiver is not visible (□ 2, 54).
- The remote is too far from the camera (□ 54).
- Bright light is interfering with remote.

---

**Smudges appear in photographs:** Clean the front and rear lens elements or the dust shield (□ 163).

---

**Flicker or banding appears in movies or in the displays:** Choose a **Flicker reduction** setting that matches the local AC power supply (□ 153).

---

**Menu items are unavailable:** Some options are only available in particular shooting or exposure modes (□ 49).

---

***Shooting (P, S, A, and M Modes)***

---

**The shutter release is disabled:** You selected **S Shutter-priority auto** for **Exposure mode** after selecting a shutter speed of “Bulb” in manual exposure mode (□ 109).

---

**Some shutter speeds are not available:** You are using a flash (□ 61).

---

**Colors are unnatural:**

- Adjust white balance to match the light source (□ 119).
- Adjust Picture Control settings (□ 125).

---

**Cannot measure white balance:** The subject is too dark or too bright (□ 122).

---

**Picture Controls produce varying results:** **A** (auto) is selected for sharpening, contrast, or saturation. For consistent results over a series of photos, choose another setting (□ 127).

---

**Picture Control brightness and contrast can not be adjusted:** Active D-Lighting is on (□ 127, 132).

---

**Metering can not be changed:** Exposure lock is in effect (□ 118).

---

**Noise (reddish areas and other artifacts) appears in long time-exposures:** Enable long-exposure noise reduction (□ 133).

## **Movies**

---

**Cannot record movies:** The movie-record button can not be used to record movies in still image, Smart Photo Selector, or Motion Snapshot mode (☞ 25, 33, 47).

---

**No sound is recorded for movies:**

- **Microphone off** is selected for **Movie sound options > Microphone** (☞ 134).
- Live audio is not recorded with slow-motion movies (☞ 40) or Motion Snapshots (☞ 45).

## **Playback**

---

**NEF (RAW) images are not displayed:** The camera displays only the JPEG copies of NEF (RAW) + JPEG fine images (☞ 114).

---

**“Tall” (portrait) orientation photos are displayed in “wide” (landscape) orientation:**

- Select **On** for **Rotate tall** (☞ 96).
  - The photos were taken with **Auto image rotation off** (☞ 155).
  - Camera was pointed up or down when the photo was taken (☞ 155).
  - Photo is displayed in image review (☞ 96).
- 

**Cannot hear movie sound:**

- Press  up to raise the volume (☞ 42). If the camera is connected to a television (☞ 84), use the controls for the TV to adjust the volume.
  - Live audio is not recorded with slow-motion movies (☞ 40) or Motion Snapshots (☞ 47).
- 



---

**Cannot delete images:**

- Remove protection from the files before deletion (☞ 96).
- The memory card is locked (☞ 14).

---

**Cannot select photos for printing:** The memory card is full (☞ 20) or locked (☞ 14) or the photos are in NEF (RAW) format. To print NEF (RAW) photos, transfer the pictures to a computer and use the supplied software or Capture NX 2 (☞ 79).

---

**Pictures are not displayed on TV:** The camera is not correctly connected (☞ 84).

---

**Pictures cannot be transferred to a computer:** If your system does not meet the requirements on page 77, you may still be able to transfer pictures to the computer using a card reader.

---

**Photos are not displayed in Capture NX 2:** Update to the latest version (☞ 158).

---

**Miscellaneous**

---

**The camera is unresponsive:** In extremely rare instances, the display may not respond as expected and the camera may stop functioning. In most cases, this phenomenon is caused by a strong external static charge. Turn the camera off, remove and replace the battery, taking care to avoid burns, and turn the camera on again, or, if you are using an AC adapter (available separately), disconnect and reconnect the adapter and turn the camera on again. If the problem persists after the battery has been removed and replaced, contact your retailer or Nikon-authorized service representative.

---

**The date of recording is not correct:** Set the camera clock (☞ 18, 154).

---

**Menu items are unavailable:** Some options are only available at particular settings (☞ 49) or when a memory card is inserted (☞ 13, 93).

## Error Messages

This section lists the error messages that appear in the display.

Message	Solution	
Rotate the zoom ring to extend the lens.	A lens with a retractable lens barrel button is attached with the lens barrel retracted. Press the retractable lens barrel button and rotate the zoom ring to extend the lens.	16, 187
Check lens. Pictures can only be taken when a lens is attached.	Attach a lens.	16
Cannot take pictures. Insert fully-charged battery.	Turn the camera off and recharge the battery or insert a fully charged spare battery.	11, 13
Start-up error. Turn the camera off and then on again.	Turn the camera off, remove and replace the battery, and then turn the camera on.	13, 17
The clock has been reset.	Set the camera clock.	18, 154
No memory card.	Turn the camera off and confirm that the card is correctly inserted.	13
This memory card is not formatted. Format the memory card?	Select <b>Yes</b> to format the card, or turn the camera off and insert another memory card.	13, 149
Memory card is locked (write protected).	Turn the camera off and slide the card write-protect switch to the "write" position.	14



Message	Solution	
Memory card is full.	• You may be able to record additional images if you reduce image quality or size.	114
	• Delete unwanted images.	69
	• Insert another memory card.	13, 160
This memory card cannot be used. Card may be damaged; insert a different card.	• Use an approved card.	160
	• Format the card. If the problem persists, the card may be damaged. Contact a Nikon-authorized service representative.	149
	• Insert a new memory card.	13, 160
Cannot create additional folders on memory card.	If the current folder is numbered 999 and contains either 999 photographs or a photograph numbered 9999, the shutter-release button will be disabled and no further photographs can be taken. Choose <b>Yes</b> for <b>Reset file numbering</b> and then either format the current memory card or insert a new memory card.	153
The movie-record button can not be used in this mode.	The movie-record button can not be used in Smart Photo Selector, still image, or Motion Snapshot mode.	25, 33, 47
Stills can not be taken when slow motion is selected.	The shutter-release button can not be used to take photographs while a slow-motion movie is being recorded.	39



Message	Solution	
Hi	<ul style="list-style-type: none"> <li>• Lower ISO sensitivity.</li> <li>• Choose a faster shutter speed or smaller aperture (higher f-number).</li> </ul>	124 109, 110, 111
Lo	<ul style="list-style-type: none"> <li>• Raise ISO sensitivity.</li> <li>• Use the built-in flash.</li> <li>• Choose a slower shutter speed or larger aperture (lower f-number).</li> </ul>	124 58 109, 110, 111
Photographs cannot be taken in shutter-priority auto mode at a shutter speed of "Bulb".	Choose a different shutter speed, or select <b>M Manual</b> for <b>Exposure mode</b> .	109, 111
Failed to update lens firmware. Contact a Nikon-authorized service center.	An unsuccessful attempt has been made to update the firmware of the lens mounted on the camera. Contact a Nikon-authorized service representative.	—
An error has occurred. Press the shutter-release button again.	Press the shutter-release button. Contact a Nikon-authorized service representative if the problem persists or re-occurs frequently.	—



Message	Solution	
An error has occurred in the internal circuitry. Contact a Nikon-authorized service center.	Contact a Nikon-authorized service representative.	—
The camera's internal temperature is high. The camera will now turn off.	Wait for the camera to cool.	xvi
Memory card contains no images.	To view pictures, insert a memory card containing images.	13
Cannot display this file.	The file has been created or modified on a computer or different make of camera, or is corrupt.	—
Cannot select this file.		
Check printer.	Check the printer.	—*
Check paper.	Select <b>Resume</b> after loading paper of the correct size.	—*
Paper jam.	Clear the jam and select <b>Resume</b> .	—*
Out of paper.	Insert paper and select <b>Resume</b> .	—*
Check ink supply.	Select <b>Resume</b> after checking the ink.	—*
Out of ink.	Replace the ink and select <b>Resume</b> .	—*

\* See the printer manual for more information.







## Specifications

### Nikon 1 J1 Digital Camera

<b>Type</b>		
Type	Digital camera with interchangeable lenses	
Lens mount	Nikon 1 mount	
Effective angle of view	Approx. 2.7× lens focal length (Nikon CX format)	
Effective pixels	10.1 million	
<b>Image sensor</b>		
Image sensor	13.2 mm × 8.8 mm CMOS sensor	
<b>Storage</b>		
Image size (pixels)	<b>Still images (still image and Smart Photo Selector modes, aspect ratio 3 : 2)</b>	
	• 3,872 × 2,592	• 2,896 × 1,944
	• 1,936 × 1,296	
	<b>Still images (movie mode, aspect ratio 16 : 9)</b>	
	• 3,840 × 2,160 (1080/60i)	• 1,920 × 1,080 (1080/30p)
	• 1,280 × 720 (720/60p)	
	<b>Still images (Motion Snapshot mode, aspect ratio 16 : 9)</b>	
	• 3,840 × 2,160	
File format	<ul style="list-style-type: none"><li>• <b>NEF (RAW):</b> 12-bit, compressed</li><li>• <b>JPEG:</b> JPEG-Baseline compliant with fine (approx. 1 : 4), normal (approx. 1 : 8), or basic (approx. 1 : 16) compression</li><li>• <b>NEF (RAW) + JPEG:</b> Single photograph recorded in both NEF (RAW) and JPEG formats</li></ul>	
Picture Control system	Standard, Neutral, Vivid, Monochrome, Portrait, Landscape; selected Picture Control can be modified; storage for custom Picture Controls	
Media	SD (Secure Digital), SDHC, and SDXC memory cards	
File system	DCF (Design Rule for Camera File System) 2.0, DPOF (Digital Print Order Format), Exif (Exchangeable Image File Format for Digital Still Cameras) 2.3, PictBridge	





<b>Shooting modes</b>	 still image (3:2),  Smart Photo Selector (3:2),  movie (HD 16:9, slow motion 8:3),  Motion Snapshot (16:9)
<b>Shutter</b>	
<b>Type</b>	Electronic shutter
<b>Speed</b>	1/16,000–30 s in steps of 1/3 EV; Bulb; Time (requires optional ML-L3 remote control)
<b>Flash sync speed</b>	Synchronizes with shutter at X=1/60 s or slower
<b>Release</b>	
<b>Mode</b>	<ul style="list-style-type: none"> <li>• Single frame, continuous, Electronic (Hi)</li> <li>• Self-timer, delayed remote, quick-response remote, interval timer shooting</li> </ul>
<b>Frame advance rate</b>	<ul style="list-style-type: none"> <li>• <b>Electronic (Hi):</b> Approx. 10, 30, or 60 fps</li> <li>• <b>Other modes:</b> Up to 5 fps (single AF or manual focus, <b>S</b> Shutter-priority auto or <b>M</b> Manual exposure mode, shutter speed 1/250 s or faster, and other settings at default values)</li> </ul>
<b>Self-timer</b>	2 s, 5 s, 10 s
<b>Remote control modes</b>	Delayed remote (2 s); quick-response remote
<b>Exposure</b>	
<b>Metering</b>	TTL metering using image sensor
<b>Metering method</b>	<ul style="list-style-type: none"> <li>• <b>Matrix</b></li> <li>• <b>Center-weighted:</b> Meters 4.5 mm circle in center of frame</li> <li>• <b>Spot:</b> Meters 2 mm circle centered on selected focus area</li> </ul>
<b>Mode</b>	Programmed auto with flexible program; shutter-priority auto; aperture-priority auto; manual; scene auto selector
<b>Exposure compensation</b>	-3–+3 EV in increments of 1/3 EV
<b>Exposure lock</b>	Luminosity locked at metered value with  (AE-L/AF-L) button
<b>ISO sensitivity (Recommended Exposure Index)</b>	ISO 100–3200 in steps of 1 EV. Can also be set to approx. 1 EV (ISO 6400 equivalent) above ISO 3200; auto ISO sensitivity control (ISO 100–3200, 100–800, 100–400) available
<b>Active D-Lighting</b>	On, off



Focus	
<b>Autofocus</b>	Hybrid autofocus (phase detection/contrast-detect AF); AF-assist illuminator
<b>Lens servo</b>	<ul style="list-style-type: none"> <li>• <b>Autofocus (AF):</b> Single AF (AF-S); continuous AF (AF-C); auto AF-S/AF-C selection (AF-A); full-time AF (AF-F)</li> <li>• <b>Manual focus (MF)</b></li> </ul>
<b>AF-area mode</b>	Single-point, auto-area, subject tracking
<b>Focus area</b>	<ul style="list-style-type: none"> <li>• <b>Single-point AF:</b> 135 focus areas</li> <li>• <b>Auto-area AF:</b> 41 focus areas</li> </ul>
<b>Focus lock</b>	Focus can be locked by pressing shutter-release button halfway (single AF) or by pressing $\text{AE-L/AF-L}$ (AE-L/AF-L) button
<b>Face-priority AF</b>	On, off
Flash	
<b>Built-in flash</b>	Raised by sliding flash pop-up control
<b>Guide Number (GN)</b>	Approx. 5/16 (m/ft, ISO 100, 20 °C/68 °F)
<b>Control</b>	i-TTL flash control using image sensor available
<b>Mode</b>	Fill flash, slow sync, red-eye reduction, slow sync with red-eye reduction, rear-curtain sync, rear curtain with slow sync
<b>Flash compensation</b>	-3 – +1 EV in increments of $\frac{1}{3}$ EV
<b>Flash-ready indicator</b>	Lights when built-in flash unit is fully charged
White balance	
	Auto, incandescent, fluorescent, direct sunlight, flash, cloudy, shade, preset manual, all except preset manual with fine tuning



<b>Movie</b>	
<b>Metering</b>	TTL metering using image sensor
<b>Metering method</b>	<ul style="list-style-type: none"> <li>• <b>Matrix</b></li> <li>• <b>Center-weighted:</b> Meters 4.5 mm circle in center of frame</li> <li>• <b>Spot:</b> Meters 2 mm circle centered on selected focus area</li> </ul>
<b>Frame size (pixels)/ recording rate</b>	<b>HD movies</b> <ul style="list-style-type: none"> <li>• 1,920 × 1,080/60i (59.94 fields/s*)</li> <li>• 1,920 × 1,080/30p (29.97 fps)</li> <li>• 1,280 × 720/60p (59.94 fps)</li> </ul>
	<b>Slow-motion movies</b> <ul style="list-style-type: none"> <li>• 640 × 240/400 fps (plays at 30p/29.97 fps)</li> <li>• 320 × 120/1,200 fps (plays at 30p/29.97 fps)</li> </ul>
	<b>Motion Snapshot</b> 1,920 × 1,080/60p (59.94 fps) (plays at 24p/23.976 fps)
<b>File format</b>	MOV
<b>Video compression</b>	H.264/MPEG-4 Advanced Video Coding
<b>Audio recording format</b>	AAC
<b>Audio recording device</b>	Built-in stereo microphone; sensitivity adjustable
* Sensor output is about 60 fps.	
<b>Monitor</b>	7.5 cm/3-in., approx. 460k-dot, TFT LCD with brightness adjustment
<b>Playback</b>	Full-frame and thumbnail (4, 9, or 72 images or calendar) playback with playback zoom, movie playback, slide show, histogram display, auto image rotation, and rating option
<b>Interface</b>	
<b>USB</b>	Hi-Speed USB
<b>HDMI output</b>	Type C mini-pin HDMI connector



<b>Supported languages</b>	Arabic, Chinese (Simplified and Traditional), Czech, Danish, Dutch, English, Finnish, French, German, Greek, Hungarian, Indonesian, Italian, Japanese, Korean, Norwegian, Polish, Portuguese, Romanian, Russian, Spanish, Swedish, Thai, Turkish, Ukrainian
<b>Power source</b>	
<b>Battery</b>	One rechargeable Li-ion EN-EL20 battery
<b>AC adapter</b>	EH-5b AC adapter; requires EP-5C power connector (available separately)
<b>Tripod socket</b>	1/4-in. (ISO 1222)
<b>Dimensions/weight</b>	
<b>Dimensions (W × H × D)</b>	Approx. 106.0 × 61.0 × 29.8 mm/ 4.2 × 2.4 × 1.2 in., excluding projections
<b>Weight</b>	Approx. 277 g/9.8 oz with battery and memory card but without body cap; approx. 234 g/8.3 oz (camera body only)
<b>Operating environment</b>	
<b>Temperature</b>	0–40 °C/+32–104 °F
<b>Humidity</b>	Less than 85% (no condensation)

- Unless otherwise stated, all figures are for a camera with a fully-charged battery operating at an ambient temperature of 20 °C (68 °F).
- Nikon reserves the right to change the specifications of the hardware and software described in this manual at any time and without prior notice. Nikon will not be held liable for damages that may result from any mistakes that this manual may contain.



<b>MH-27 battery charger</b>	
<b>Rated input</b>	AC 100–240 V, 50–60 Hz, 0.2 A
<b>Rated output</b>	DC 8.4 V/0.6 A
<b>Supported batteries</b>	Nikon EN-EL20 rechargeable Li-ion batteries
<b>Charging time</b>	Approx. 2 hours at an ambient temperature of 25 °C/77 °F when no charge remains
<b>Operating temperature</b>	0–40 °C/+32–104 °F
<b>Dimensions (W × H × D)</b>	Approx. 67.0 × 28.0 × 94.0 mm/2.6 × 1.1 × 3.7 in., excluding plug adapter
<b>Weight</b>	Approx. 83 g/2.9 oz, excluding plug adapter
<b>EN-EL20 rechargeable Li-ion battery</b>	
<b>Type</b>	Rechargeable lithium-ion battery
<b>Rated capacity</b>	7.2 V, 1,020 mAh
<b>Operating temperature</b>	0–40 °C/+32–104 °F
<b>Dimensions (W × H × D)</b>	Approx. 30.7 × 50.0 × 14.0 mm/1.2 × 2.0 × 0.6 in.
<b>Weight</b>	Approx. 41 g/1.4 oz, excluding terminal cover



**1 NIKKOR VR 10–30 mm f/3.5–5.6**

<b>Type</b>	1 mount lens
<b>Focal length</b>	10–30 mm
<b>Maximum aperture</b>	f/3.5–5.6
<b>Construction</b>	12 elements in 9 groups (including 3 aspherical elements)
<b>Angle of view</b>	77°–29° 40'
<b>Vibration reduction</b>	Lens shift using voice coil motors (VCMs)
<b>Minimum focus distance</b>	0.2 m/0.7 ft from focal plane at all zoom positions
<b>Diaphragm blades</b>	7 (rounded diaphragm opening)
<b>Diaphragm</b>	Fully automatic
<b>Aperture range</b>	<ul style="list-style-type: none"><li>• <b>10 mm focal length:</b> f/3.5–16</li><li>• <b>30 mm focal length:</b> f/5.6–16</li></ul>
<b>Filter-attachment size</b>	40.5 mm (P=0.5 mm)
<b>Dimensions</b>	Approx. 57.5 mm diameter × 42 mm (distance from camera lens mount flange when lens is retracted)
<b>Weight</b>	Approx. 115 g/4.1 oz

Specifications subject to change without notice. Nikon will not be held liable for damages that may result from any mistakes that this manual may contain.



## ■ ■ The 1 NIKKOR VR 10–30 mm f/3.5–5.6

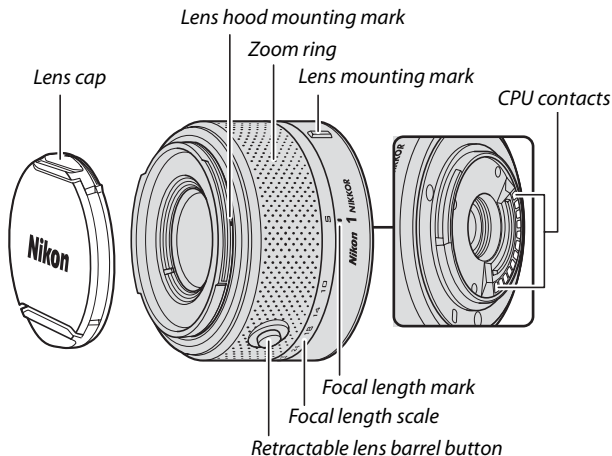

1 NIKKOR lenses are exclusively for Nikon 1 interchangeable lens format digital cameras. The angle of view is equivalent to a 35 mm format lens with a focal length about  $2.7 \times$  longer. They support normal and active vibration reduction and vibration reduction off (📖 136).

Use the zoom ring to zoom in and out.



### Lens Care

- When using an optional lens hood, do not pick up or hold the lens or camera using only the hood.
- Keep the CPU contacts clean.
- Use a blower to remove dust and lint from the lens surfaces. To remove smudges and fingerprints, apply a small amount of ethanol or lens cleaner to a soft, clean cotton cloth or lens-cleaning tissue and clean from the center outwards using a circular motion, taking care not to leave smears or touch the glass with your fingers.
- Never use organic solvents such as paint thinner or benzene to clean the lens.
- A lens hood or NC filter can be used to protect the front lens element.
- Attach the front and rear caps when the lens is not in use.
- If the lens will not be used for an extended period, store it in a cool, dry location to prevent mold and rust. Do not store in direct sunlight or with naphtha or camphor moth balls.
- Keep the lens dry. Rusting of the internal mechanism can cause irreparable damage.
- Leaving the lens in extremely hot locations could damage or warp parts made from reinforced plastic.

### Supplied Accessories

- 40.5 mm snap-on Front Lens Cap LC-N40.5
- Rear Lens Cap LF-N1000

### Optional Accessories

- 40.5 mm screw-on filters
- Semi-soft Case CL-N101
- Bayonet Hood HB-N101 (attaches as shown below).

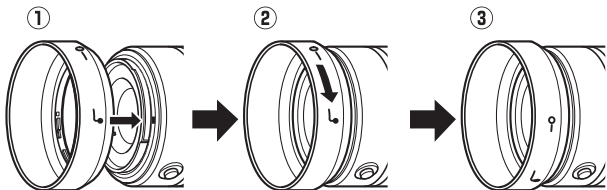



## ■ Supported Standards

- **DCF Version 2.0:** The Design Rule for Camera File Systems (DCF) is a standard widely used in the digital camera industry to ensure compatibility among different makes of camera.
- **DPOF:** Digital Print Order Format (DPOF) is an industry-wide standard that allows pictures to be printed from print orders stored on the memory card.
- **Exif version 2.3:** The camera supports Exif (Exchangeable Image File Format for Digital Still Cameras) version 2.3, a standard in which information stored with photographs is used for optimal color reproduction when the images are output on Exif-compliant printers.
- **PictBridge:** A standard developed through cooperation with the digital camera and printer industries, allowing photographs to be output directly to a printer without first transferring them to a computer.
- **HDMI:** High-Definition Multimedia Interface is a standard for multimedia interfaces used in consumer electronics and AV devices capable of transmitting audiovisual data and control signals to HDMI-compliant devices via a single cable connection.

## Trademark Information

Macintosh, Mac OS, and QuickTime are registered trademarks of Apple Inc. in the United States and/or other countries. Microsoft, Windows, and Windows Vista are either registered trademarks, or trademarks of Microsoft Corporation in the United States and/or other countries. The PictBridge logo is a trademark. The SD, SDHC, and SDXC logos are trademarks of SD-3C, LLC. HDMI, the **HDMI** logo and High-Definition Multimedia Interface are trademarks or registered trademarks of HDMI Licensing LLC. All other trade names mentioned in this manual or the other documentation provided with your Nikon product are trademarks or registered trademarks of their respective holders.



## Battery Life

---

The number of shots that can be taken with fully-charged batteries varies with the condition of the battery, temperature, the interval between shots, and the length of time menus are displayed. Sample figures for EN-EL20 (1020 mAh) batteries are given below.

- **Still images: Approximately 230**

- **Movies: Approximately 70 minutes of HD footage at 1080/60i**

Values for still images measured at 25 °C/77 °F with a fully-charged EN-EL20 battery, a 1 NIKKOR VR 10–30mm f/3.5–5.6 lens, and a 16 GB Toshiba R95 W80MB/s UHS-I SDHC card according to the CIPA standard under the following test conditions: NORMAL-quality photographs taken at intervals of 30 s with the flash fired with every other shot and the camera turned off and then on after every ten shots.

The following can reduce battery life:

- Keeping the shutter-release button pressed halfway
- Repeated autofocus operations
- Taking NEF (RAW) photographs
- Slow shutter speeds
- Using vibration reduction mode with VR lenses





























To ensure that you get the most from rechargeable Nikon EN-EL20 batteries:



- Keep the battery contacts clean. Soiled contacts can reduce battery performance.
- Use batteries immediately after charging. Batteries will lose their charge if left unused.



# Index

## Symbols

 (Still image mode) .....	21
 (Smart Photo Selector mode) .....	31
 (Movie mode) .....	37
 (Motion Snapshot mode) .....	45
 (Scene auto selector) .....	21, 106
 (Portrait) .....	21
 (Landscape) .....	21
 (Close up) .....	21
 (Night portrait) .....	21
 (Auto) .....	21
<b>P</b> (Programmed auto) .....	106, 108
<b>S</b> (Shutter-priority auto) .....	106, 109
<b>A</b> (Aperture-priority auto) .....	106, 110
<b>M</b> (Manual) .....	106, 111
<b>*</b> (flexible program) .....	108
<b>MENU</b> (menu) button .....	9, 93, 103, 147
 (playback) button .....	28, 34, 48
 (delete) button .....	29, 35, 43, 48, 69
<b>DISP</b> (display) button .....	5, 63
<b>F</b> (feature) button .....	8, 26, 39, 47, 70
 (OK) button .....	34, 42, 48
 (AE-L/AF-L) .....	118, 144
 (exposure compensation) .....	56
 (self-timer) .....	53
 (playback zoom/thumbnail) control .....	28, 42, 66, 68, 141
<b>PRE</b> (Preset manual) .....	121
 2s (delayed remote) .....	53
 (quick-response remote) .....	53
 (single frame) .....	26
 (continuous) .....	26
 (electronic (Hi)) .....	26
 (matrix) .....	117
 (centerweighted) .....	117
 (spot) .....	117
 (auto-area) .....	142
 (single-point) .....	142
 (subject tracking) .....	142

 (red-eye reduction) .....	58
<b>SLOW</b> (slow sync) .....	58
<b>REAR</b> (rear curtain sync) .....	58
 (flash-ready indicator) .....	58

## A

<b>AC</b> adapter .....	158, 161
<b>Access</b> lamp .....	24
<b>Accessories</b> .....	157
<b>Active D-Lighting</b> .....	132
<b>Adobe RGB</b> .....	131
<b>AE</b> lock .....	118, 152
<b>AE-L</b> .....	118, 144
<b>AE-L/AF-L</b> button .....	118, 144, 152
<b>AF</b> .....	137, 142
<b>AF-A</b> .....	137
<b>AF-area</b> mode .....	142
<b>AF-assist</b> illuminator .....	138, 145
<b>AF-C</b> .....	137
<b>AF-F</b> .....	137
<b>AF-S</b> .....	137
<b>Aperture</b> .....	107, 110, 111
<b>Aperture-priority</b> auto .....	110, 111
<b>Assign</b> AE/AF-L button .....	152
<b>Attaching</b> the lens .....	16
<b>Auto</b> image rotation .....	155
<b>Auto</b> power off .....	17, 151
<b>Auto-area</b> AF (AF-area mode) .....	142
<b>Autofocus</b> .....	137, 142
<b>Automatic</b> scene selection .....	21
<b>Auto-select</b> AF .....	137
<b>Available</b> settings .....	49

## B

<b>Background</b> track .....	48, 72, 82
<b>Battery</b> .....	11, 13, 20, 185
<b>Beep</b> .....	23, 54, 151
<b>Best</b> shot .....	31, 34
<b>Body</b> cap .....	1, 2, 159
<b>Border</b> .....	91



Brightness .....	127
Buffering .....	32, 46
Built-in AF assist .....	138, 145
Built-in Flash .....	58
Bulb .....	112
Burst .....	26

## C

Calendar .....	67, 71
Calendar playback .....	67
Capture NX 2 .....	115, 130, 158
CEC .....	85
Center-weighted (Metering) .....	117
Charging a battery .....	11
Clock .....	18, 19, 154
Clock battery .....	19
Color space .....	131
Color temperature .....	123
Compatible lens .....	157
Computer .....	75
Continuous .....	26
Continuous AF .....	137
Contrast .....	127, 132
Creating short movies .....	81, 82
Crop .....	91, 99
Custom Picture Control .....	126, 129

## D

Date and time .....	18, 154
Date format .....	18, 154
Daylight saving time .....	18, 154
DCF version 2.0 .....	131, 189
Defaults .....	168
Delayed remote .....	53
Delete .....	29, 35, 43, 48, 69
Delete all images .....	69
Delete current image .....	29, 35, 43, 48, 69
Delete selected images .....	69
Detailed display .....	4, 5
Detailed photo information .....	5, 64
Digital Print Order Format .....	189
Discard .....	69

D-Lighting .....	97
DPOF .....	88, 92, 189
DPOF print order .....	88, 92
Dust shield .....	2, 163

## E

Edit movie .....	100
Electronic (Hi) .....	26
Exif version 2.3 .....	131, 189
Exposure .....	56, 106, 117, 118
Exposure compensation .....	56
Exposure indicator .....	111
Exposure lock .....	118, 152
Exposure mode .....	106

## F

Face-priority AF .....	23, 145
Fade in/fade out .....	133
Feature button .....	8, 26, 39, 47, 70
Fill flash .....	58
Filter effects .....	127, 128
Fine-tuning white balance .....	120
Firmware version .....	155
Flash .....	58, 146
Flash compensation .....	146
Flash mode .....	59
Flash range .....	61
Flash-ready indicator .....	58
Flexible program .....	108
Flicker reduction .....	153
f-number .....	107, 157
Focal length .....	22, 64
Focal length scale .....	22, 187
Focal plane mark .....	2, 141
Focus .....	137, 142
Focus area .....	23, 142
Focus lock .....	143
Focus mode .....	137
Format .....	14, 149
Format memory card .....	14, 149
Frame rate .....	63, 116
Full-frame playback .....	28, 63
Full-time AF .....	137



**G**

Grid display .....5, 150

**H**

H.264 ..... 183

HD Movies ..... 37, 116

HDMI ..... 84, 85, 189

HDMI device control .....85

HDMI-CEC .....85

High definition ..... 84, 85, 189

High ISO noise reduction ..... 133

Histogram .....65

Hue ..... 127

**I**

Image quality ..... 114

Image selection .....95

Image size ..... 114

Index print .....88

Infrared receiver ..... 2, 54

Interval timer shooting ..... 135

ISO sensitivity ..... 124

**J**

JPEG ..... 114

**L**

Landscape ..... 21, 125

Language ..... 18, 154

Lens ..... 16, 22, 136, 157, 186

Lens cap ..... 16

Lens mount ..... 141

Load from/save to card ..... 130

Long exposure NR ..... 133

**M**

Manual ..... 106, 111

Manual focus ..... 140

Matrix (Metering) ..... 117

Maximum aperture ..... 186

Memory buffer .....23

Memory card ... 13, 15, 149, 160, 169

Memory card capacity ..... 169

Metering .....117

Microphone .....38, 134

Mode dial .....6

Monitor .....4, 5, 150

Monitor brightness .....150

Monochrome .....125

Motion Snapshot .....6, 45

Motion Snapshot mode .....6, 45

MOV .....115

Movie mode .....6, 37

Movie settings .....116

Movie sound options .....134

Movie type ..... 39

Movie-record button ..... 38, 41

Movies .....37, 116

Multi selector .....7

**N**

NEF ..... 114, 115

NEF (RAW) ..... 114, 115

Neutral .....125

Night portrait ..... 21

Nikon Transfer 2 ..... 79

**P**

Photo information .....5, 63

PictBridge .....86, 189

Picture Control ..... 125, 129

Playback ..... 28, 63

Playback menu ..... 93

Playback zoom ..... 68

Portrait .....21, 125

Power connector ..... 158, 161

Power drive zoom switch ..... 22

Power switch ..... 17

Preset manual ..... 119, 121

Press the shutter-release button all

the way down ..... 24, 25

Press the shutter-release button

halfway ..... 23, 25, 32, 46

Print date ..... 92

Print DPOF print order ..... 88

Printing ..... 86



Programmed auto ..... 106, 108  
Protect ..... 96

## Q

Quick adjust .....127  
Quick-response remote ..... 53

## R

Rating ..... 70, 96  
Rear-curtain sync ..... 58  
Red-eye reduction ..... 58  
Remote control ..... 53  
Remote on duration ..... 152  
Removing the lens from the camera  
16  
Reset file numbering ..... 153  
Reset setup options ..... 149  
Reset shooting options ..... 105  
Resize ..... 98  
Retractable lens barrel button .... 16,  
22, 187  
Rotate tall ..... 96

## S

Saturation .....127  
Scene auto selector .....21, 106  
SD card .....160  
Select by date ..... 88  
Select images for printing ..... 88  
Self-portrait ..... 53  
Self-timer ..... 53  
Sensitivity .....124  
Sensor protection barrier .....187  
Setup menu .....147  
Sharpening .....127  
Shooting menu .....103  
Short Movie Creator ..... 75, 81, 82  
Shutter button AE lock .....152  
Shutter speed .....107, 109, 111  
Shutter-priority auto .....109  
Shutter-release button .... 23, 25, 32,  
46, 152  
Simple photo information ..... 63

Simplified display .....5  
Single AF ..... 137  
Single-point ..... 142  
Size .....98, 114, 116, 180, 183  
Slide show ..... 71  
Slot empty release lock ..... 149  
Slow motion .....40, 116  
Slow sync ..... 58  
Smart Photo Selector mode .....6, 31  
Sound settings ..... 151  
Speaker .....2  
Spot (Metering) ..... 117  
sRGB ..... 131  
Standard ..... 125  
Still image mode .....6, 21  
Strap ..... 11  
Subject tracking ..... 142  
System requirements ..... 77

## T

Television ..... 84  
Temperature warnings .....xvi  
Theme ..... 47  
Thumbnail playback ..... 66  
Time ..... 18, 53, 112, 154  
Time stamp ..... 91  
Time zone ..... 154  
Time zone and date ..... 154  
Timer .....53, 135  
Toning ..... 127, 128  
Trimming movies ..... 100  
Tripod mounting spacer .....55, 159

## U

USB ..... 79, 86  
USB cable ..... 79, 86

## V

Vibration reduction ..... 136  
ViewNX 2 ..... 75  
Vivid ..... 125  
Volume ..... 42, 73  
VR ..... 136



## **W**

---

Welcome screen .....	150
White balance .....	119
Wind noise reduction .....	134

## **Z**

---

Zoom guide .....	22
Zoom ring .....	22, 187



# ***Nikon***

No reproduction in any form of this manual, in whole or in part (except for brief quotation in critical articles or reviews), may be made without written authorization from NIKON CORPORATION.



**NIKON CORPORATION**

© 2011 Nikon Corporation

SB1102(11)  
6MVA1411-02