

OLYMPUS[®]

DIGITAL CAMERA

TG-820

TG-620

Instruction Manual

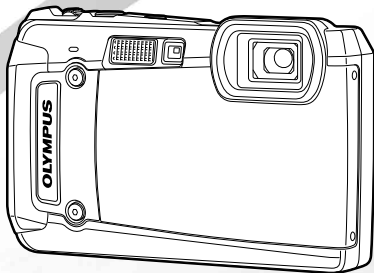

- Thank you for purchasing an Olympus digital camera. Before you start to use your new camera, please read these instructions carefully to enjoy optimum performance and a longer service life. Keep this manual in a safe place for future reference.
- We recommend that you take test shots to get accustomed to your camera before taking important photographs.
- In the interest of continually improving products, Olympus reserves the right to update or modify information contained in this manual.
- The screen and camera illustrations shown in this manual were produced during the development stages and may differ from the actual product. Unless otherwise specified, the explanation about these illustrations is provided for TG-820.

Checking the contents of the box



Digital camera



Strap



Lithium Ion
Battery
(LI-50B)



or



USB-AC adapter (F-2AC)



USB cable
(CB-USB8)



AV cable
(CB-AVC3)



OLYMPUS Setup
CD-ROM

Other accessories not shown: Warranty card
Contents may vary depending on purchase location.

Names of Parts

Camera unit

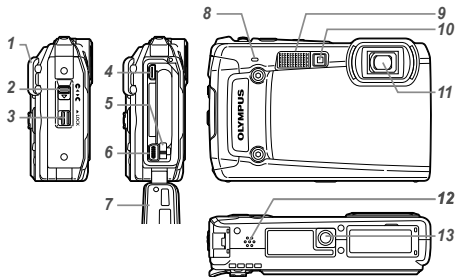

- 1 Strap eyelet
- 2 Battery/card/connector cover latch*1
- 3 Lock knob
- 4 HDMI micro connector
- 5 Battery lock knob
- 6 Multi-connector
- 7 Battery/card/connector cover*1
- 8 Microphone
- 9 Flash
- 10 Self-timer lamp/LED illuminator
- 11 Lens
- 12 Speaker*1
- 13 Tripod socket
- 14 Connector cover*2
- 15 Connector cover latch*2
- 16 Battery/card cover latch*2
- 17 Battery/card cover*2

*1 TG-820 only

*2 TG-620 only

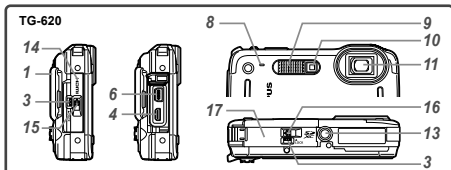

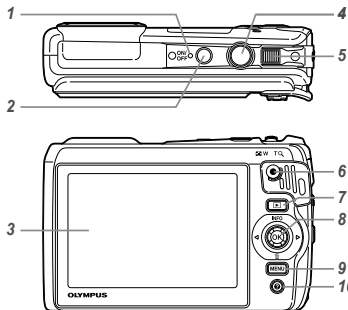

- 1** Indicator lamp
- 2** ON/OFF button
- 3** Monitor
- 4** Shutter button
- 5** Zoom lever
- 6** Movie record button
- 7** button (switching between shooting and playback)
- 8** Joystick
- INFO** (changing information display)
- (erase)
- button (OK)
- 9** MENU button
- 10** button (camera guide)
- 11** Speaker*

* TG-620 only

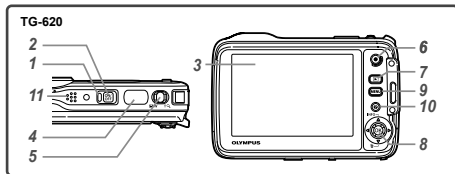

Attaching the camera strap

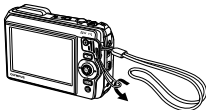

Pull the strap tight so that it does not come loose.

Shooting mode display

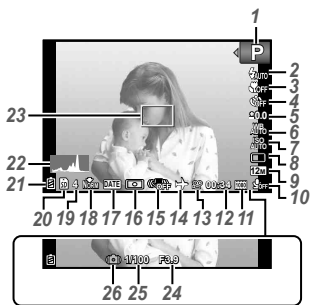

- | | |
|--|--|
| <p>1 Shooting modep. 17, 24</p> <p>2 Flash.....p. 20</p> <p>Flash standby/flash charge
.....p. 59</p> <p>3 Macro/super macro/
S-macro LED modep. 30</p> <p>4 Self-timerp. 30</p> <p>5 Exposure compensation
.....p. 31</p> <p>6 White balance.....p. 31</p> <p>7 ISOp. 32</p> <p>8 Drive.....p. 33</p> <p>9 Image size (still images)
.....p. 33, 67</p> <p>10 Recording with sound
(movies)/wind noise
reductionp. 40</p> <p>11 Image size (movies)
.....p. 40, 68</p> <p>12 Continuous recording length
(movies).....p. 18</p> <p>13 Movie recording iconp. 18</p> <p>14 World timep. 51</p> <p>15 Image stabilization
(still images).....p. 38</p> <p>16 Meteringp. 37</p> <p>17 Date stamp.....p. 39</p> <p>18 Compression (still images)
.....p. 36, 67</p> <p>19 Number of storable still
pictures (still images)
.....p. 17</p> <p>20 Current memoryp. 66</p> <p>21 Battery check.....p. 13, 60</p> <p>22 Histogramp. 20</p> <p>23 AF target mark.....p. 18</p> <p>24 Aperture value.....p. 18</p> <p>25 Shutter speed.....p. 18</p> <p>26 Camera shake warning</p> | <p>1 Shooting mode</p> <p>2 Flash</p> <p>3 Macro/super macro/
S-macro LED mode</p> <p>4 Self-timer</p> <p>5 Exposure compensation</p> <p>6 White balance</p> <p>7 ISO</p> <p>8 Drive</p> <p>9 Image size (still images)</p> <p>10 Recording with sound
(movies)/wind noise
reduction</p> <p>11 Image size (movies)</p> <p>12 Continuous recording length
(movies)</p> <p>13 Movie recording icon</p> <p>14 World time</p> <p>15 Image stabilization
(still images)</p> <p>16 Metering</p> <p>17 Date stamp</p> <p>18 Compression (still images)</p> <p>19 Number of storable still
pictures (still images)</p> <p>20 Current memory</p> <p>21 Battery check</p> <p>22 Histogram</p> <p>23 AF target mark</p> <p>24 Aperture value</p> <p>25 Shutter speed</p> <p>26 Camera shake warning</p> |
|--|--|

Playback mode display

• Standard display

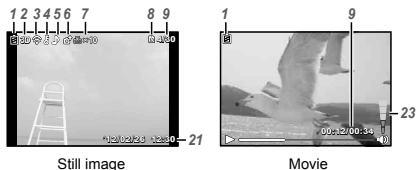

Still image

Movie

• Advanced display

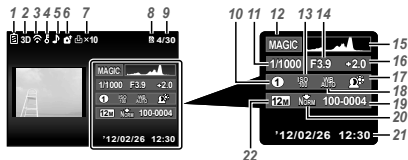

- 1 Battery check.....p. 13, 60
- 2 3D image.....p. 35
- 3 Eye-Fi transferred.....p. 45
- 4 Protect.....p. 44
- 5 Adding soundp. 42
- 6 Upload order.....p. 44
- 7 Print reservation/number of printsp. 57/p. 56
- 8 Current memoryp. 66
- 9 Frame number/total number of images (still images)p. 21
Elapsed time/total shooting time (movies)p. 22
- 10 **MAGIC** modep. 27
- 11 Shutter speedp. 18
- 12 Shooting modep. 17, 24
- 13 ISOp. 32
- 14 Aperture valuep. 18
- 15 Histogramp. 20
- 16 Exposure compensationp. 31
- 17 Shadow Adjustment Technology.....p. 36
- 18 White balance.....p. 31
- 19 File number
- 20 Compression (still images)p. 36, 67
- 21 Date and timep. 16, 51
- 22 Image sizep. 33, 40, 67, 68
- 23 Volumep. 21, 47



Camera Settings

Using the Buttons

Frequently used functions can be accessed using the buttons.

TG-820



TG-620



TG-820	TG-620	
		Shutter button (p. 17, 59)
		Zoom lever (p. 19, 22)
		Ⓜ button (shooting movies) (p. 18)
		▶ button (switching between shooting and playback) (p. 18, 21, 46)
		MENU button (p. 9)
		ℹ button (camera guide) (p. 23)

Operation guide

The symbols Δ ∇ \triangleleft \triangleright displayed for image selections and settings indicate that the joystick shown on the right is to be used.

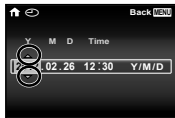

Operation guides displayed on the screen indicate that the **MENU** button, **OK** button, or zoom lever can be used.

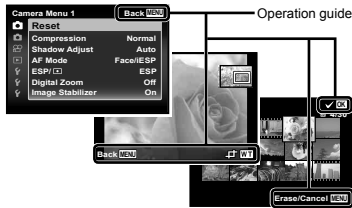

Joystick

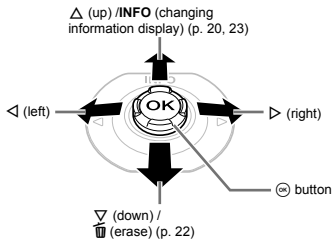

- Press the joystick up/down/left/right to operate it.
- Δ ∇ \triangleleft \triangleright instruct to press the joystick up/down/left/right.

Operating the camera by tapping the body (TG-820 only)

You can operate the camera by tapping the body when [Tap Control] (p. 52) is [On].

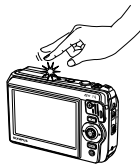

Using the Menu

Use the menu to change camera settings such as the shooting mode.

⚠ There may be menus that are unavailable depending on other related settings or the shooting mode (p. 24).

Function menu

Press \triangleleft during shooting to display the function menu. The function menu is used to choose the shooting mode and provides access to frequently used shooting settings.

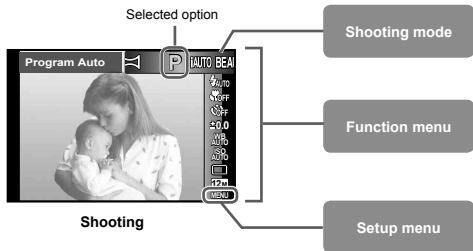

To select the shooting mode

Use \triangleleft / \triangleright to select the shooting mode and press the \odot button.

To select the function menu

Use \triangle / ∇ to select a menu option and use \triangleleft / \triangleright to select a menu option. Press the \odot button to set the function menu.

Setup menu

Press the **MENU** button during shooting or playback to display the setup menu. The setup menu provides access to a variety of camera settings, including options not listed in the function menu, display options, and the time and date.

1 Press the MENU button.

- The setup menu is displayed.

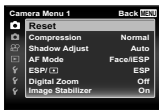

2 Press < to select the page tabs. Use < > to select the desired page tab and press >.

Page tab

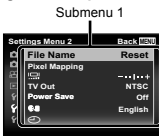
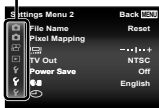

3 Use < > to select the desired submenu 1 and then press the OK button.

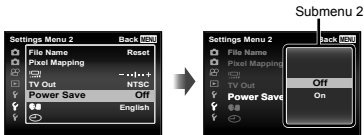

4 Use < > to select the desired submenu 2 and then press the OK button.

- Once a setting is selected, the display returns to the Submenu 1.

- ! There may be additional operations. "Menu Settings" (p. 36 to 53)

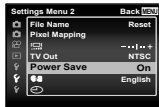

5 Press the MENU button to complete the setting.

Menu Index

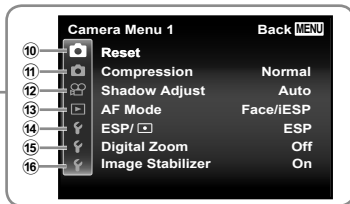

- ① Shooting modep. 17, 24
P (Program Auto)
iAUTO (iAUTO)
BEAUTY (Beauty)
SCN (Scene Mode)
MAGIC (Magic Filter)
 (Panorama)
- ② Flashp. 20
- ③ Macrop. 30
- ④ Self-timerp. 30
- ⑤ Exposure compensation...p. 31
- ⑥ White balancep. 31
- ⑦ ISOp. 32
- ⑧ Drivep. 33
- ⑨ Image Sizep. 33
- ⑩ (Camera Menu 1)p. 36
Reset
Compression
Shadow Adjust
AF Mode
ESP/
Digital Zoom
Image Stabilizer
- ⑪ (Camera Menu 2)p. 38
Rec View
Pic Orientation*
Icon Guide
Date Stamp
Super-Res Zoom
- ⑫ (Movie Menu)p. 40
Image Size
IS Movie Mode
 (Movie sound recording)
Wind Noise Reduction
- ⑬ (Playback Menu)p. 41
Slideshow
Photo Surfing
Edit
Erase
Print Order
 (Protect)
Upload Order
- ⑭ (Settings Menu 1) p. 45
Memory Format/Format
Backup
Eye-Fi
USB Connection
 Power On
Keep Settings
Sound Settings
- ⑮ (Settings Menu 2) p. 47
File Name
Pixel Mapping
 (Monitor)
TV Out
Power Save
 (Language)
 (Date/time)
- ⑯ (Settings Menu 3) p. 51
World Time
Reset Database
Beauty Settings
Tap Control*
LED Illuminator

* TG-820 only

Preparing the Camera

Inserting the battery and card

1

TG-820

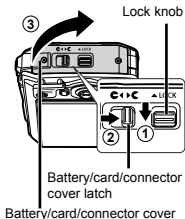

TG-620

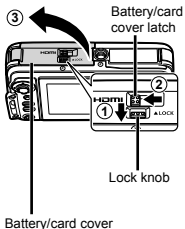

2

TG-820

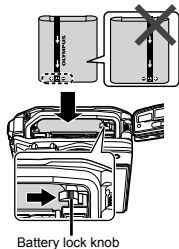

TG-620

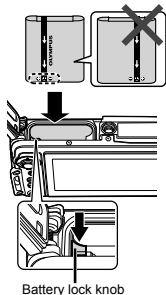

TG-820

Write-protect switch

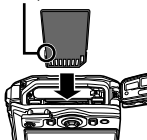

TG-620

Write-protect switch

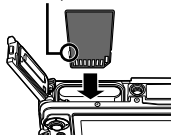

- ⚠ TG-820: Insert the battery as illustrated with the **-** mark toward the battery lock knob.
TG-620: Insert the battery as illustrated with the **+** mark toward the battery lock knob.
Damage to the battery exterior (scratches, etc.) may produce heat or an explosion.
- ⚠ Insert the battery while sliding the battery lock knob in the direction of the arrow.
- ⚠ Insert the card straight until it clicks into place.
- ⚠ Turn off the camera before opening the battery/card/connector cover*.
- ⚠ When using the camera, be sure to close and lock the battery/card/connector cover*.
- ⚠ Slide the battery lock knob in the direction of the arrow to unlock, and then remove the battery.
- ⚠ Always use SD/SDHC/SDXC cards or Eye-Fi card with this camera. Do not insert other types of memory cards. "Using the card" (p. 65)
- ⚠ Do not touch the contact area of the card directly.
- ⚠ This camera can be used without a card by storing images in its internal memory.

* TG-620: Battery/card cover and connector cover

3

TG-820

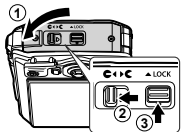

TG-620

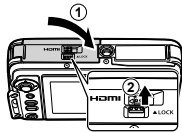

- ! "Number of storable pictures (still images)/Continuous recording length (movies) in the internal memory and cards" (p. 67, 68)

To remove the card

1

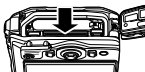

2

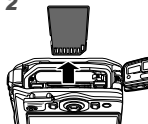

- ! Press the card in until it clicks and comes out slightly, then remove the card.

Charging the battery with the included USB-AC adapter

- ! The included F-2AC USB-AC adapter (hereafter referred to as USB-AC adapter) differs depending on the region where you purchased the camera. If you received a plug-in type USB-AC adapter, plug it directly into AC outlet.
- ! The included USB-AC adapter has been designed to be used for charging and playback. Do not take pictures while the USB-AC adapter is connected to the camera.
- ! Be sure to unplug the power plug of the USB-AC adapter from the wall outlet when the charging is complete or the playback ends.
- ! For details on the battery and the USB-AC adapter, see "Battery and USB-AC adapter" (p. 64).
- ! The battery can be charged while the camera is connected to the computer. Charging time varies depending on the performance of a computer. (There may be cases in which it takes approx. 10 hours.)

Connecting the camera

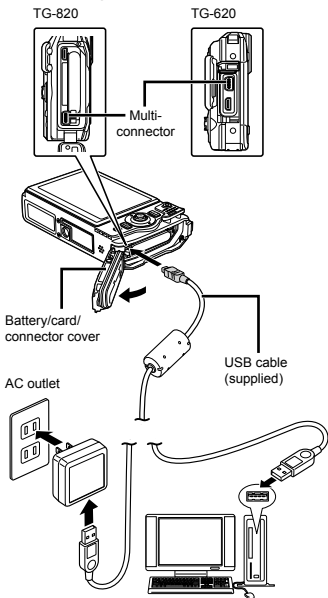

Indicator lamp

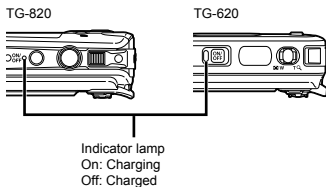

- ⚠ The battery is not fully charged at shipment. Before use, be sure to charge the battery until the indicator lamp turns off (up to 3 hours).
- ⚠ If the indicator lamp does not light, the USB-AC adapter is not connected to the camera correctly, or the battery, camera, or USB-AC adapter may be broken.

When to charge the batteries

Charge the battery when the error message shown below appears.

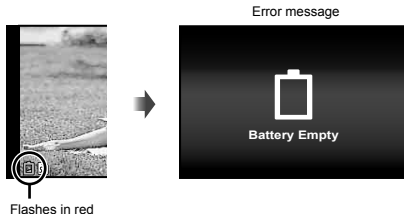

Installing the PC software and registering user

- ! Installation of [ib] computer software using the supplied CD is available on Windows computers only.

Windows

1 Insert the supplied CD in a CD-ROM drive.

Windows XP

- A "Setup" dialog will be displayed.

Windows Vista/Windows 7

- An Autorun dialog will be displayed. Click "OLYMPUS Setup" to display the "Setup" dialog.



- ! If the "Setup" dialog is not displayed, select "My Computer" (Windows XP) or "Computer" (Windows Vista/Windows 7) from the start menu. Double-click the CD-ROM (OLYMPUS Setup) icon to open the "OLYMPUS Setup" window and then double-click "Launcher.exe".
- ! If a "User Account Control" dialog is displayed, click "Yes" or "Continue".

2 Register your Olympus product.

- Click the "Registration" button and follow the on-screen instructions.
- ! To register the camera must be connected to the computer. "Connecting the camera" (p. 13)
- ! If nothing is displayed on the camera screen even after connecting the camera to the computer, the battery may be exhausted. Charge the battery and then connect the camera again.

3 Install OLYMPUS Viewer 2 and [ib] computer software.

- Check the system requirements before beginning installation.
- Click the "OLYMPUS Viewer 2" or "OLYMPUS ib" button and follow the on-screen instructions to install the software.

OLYMPUS Viewer 2

Operating System	Windows XP (Service Pack 2 or later)/ Windows Vista/Windows 7
Processor	Pentium 4 1.3 GHz or better (Core 2 Duo 2.13 GHz or better required for movies)
RAM	1 GB or more (2 GB or more recommended)
Free Hard Drive Space	1 GB or more
Monitor Settings	1024 × 768 pixels or more Minimum 65,536 colors (16,770,000 colors recommended)

[ib]

Operating System	Windows XP (Service Pack 2 or later)/ Windows Vista/Windows 7
Processor	Pentium 4 1.3 GHz or better (Core 2 Duo 2.13 GHz or better required for movies)
RAM	512 MB or more (1 GB or more recommended) (1 GB or more required for movies—2 GB or more recommended)
Free Hard Drive Space	1 GB or more
Monitor Settings	1024 × 768 pixels or more Minimum 65,536 colors (16,770,000 colors recommended)
Graphics	A minimum of 64 MB video RAM with DirectX 9 or later.

* See online help for information on using the software.

4 Install the camera manual.

- Click the “Camera Instruction Manual” button and follow the on-screen instructions.

Macintosh

1 Insert the supplied CD in a CD-ROM drive.

- Double-click the CD (OLYMPUS Setup) icon on the desktop.
- Double-click the “Setup” icon to display the “Setup” dialog.



Setup



2 Install OLYMPUS Viewer 2.

- Check the system requirements before beginning installation.
- Click the “OLYMPUS Viewer 2” button and follow the on-screen instructions to install the software.



You can register via “Registration” in OLYMPUS Viewer 2 “Help”.

OLYMPUS Viewer 2

Operating System	Mac OS X v10.4.11–v10.6
Processor	Intel Core Solo/Duo 1.5 GHz or better
RAM	1 GB or more (2 GB or more recommended)
Free Hard Drive Space	1 GB or more
Monitor Settings	1024 × 768 pixels or more Minimum 32,000 colors (16,770,000 colors recommended)

* Other languages can be selected from the language combo box. For information on using the software, see online help.

3 Copy the camera manual.

- Click the “Camera Instruction Manual” button to open the folder containing the camera manuals. Copy the manual for your language to the computer.

Language, date, time, and time zone

You can also choose the language for the menus and messages displayed in the monitor. The date and time set here are saved to image file names, date prints, and other data.

- 1 Press the ON/OFF button to turn on the camera, use $\Delta \nabla \triangleleft \triangleright$ to select your language and press the OK button.

 The menu can be used to change the selected language. [LANG] (p. 51)

- 2 Use $\Delta \nabla$ to select the year for [Y].



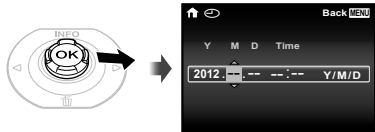

Date and time setting screen

- 3 Press \triangleright to save the setting for [Y].



- 4 As in Steps 2 and 3, use $\Delta \nabla \triangleleft \triangleright$ to set [M] (month), [D] (day), [Time] (hours and minutes), and [Y/M/D] (date order), and then press the OK button.

-  For precise time setting, press the OK button as the time signal strikes 00 seconds.
-  To change the date and time, adjust the setting from the menu. [DATE] (Date/time) (p. 51)

- 5 Use $\triangleleft \triangleright$ to select the [\uparrow] time zone and then press the OK button.

- Use $\Delta \nabla$ to turn daylight saving time ([Summer]) on or off.



-  The menu can be used to change the selected time zone. [World Time] (p. 51)

Shooting, Playback, and Erasing

Shooting with the optimum aperture value and shutter speed (P mode)

In this mode, automatic shooting settings are activated while also allowing changes to a wide range of other shooting menu functions, such as exposure compensation, white balance, etc. as needed.

! The default settings of the function are highlighted in .

1 Press the ON/OFF button to turn on the camera.

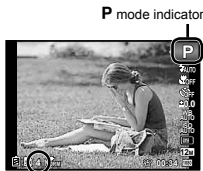

Number of storable still pictures (p. 67)

Monitor (standby mode screen)

! If **P** mode is not displayed, press  to display the function menu screen and then set the shooting mode to **P**. "Using the Menu" (p. 8)

Current shooting mode display



2 Hold the camera and compose the shot.

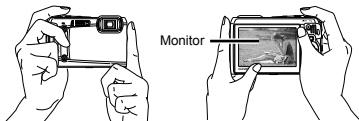

Horizontal grip



Vertical grip

! When holding the camera, take care not to cover the flash and microphone with your fingers, etc.

3 Press the shutter button halfway down to focus on the subject.

- When the camera focuses on the subject, the exposure is locked (shutter speed and aperture value are displayed), and the AF target mark changes to green.
- The camera was unable to focus if the AF target mark flashes red. Try focusing again.

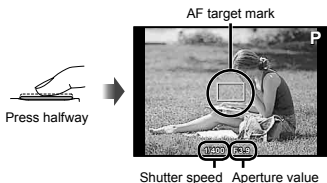

! "Focusing" (p. 61)

- 4 To take the picture, gently press the shutter button all the way down while being careful not to shake the camera.**



To view images during shooting

Pressing the button enables playback of images. To return to shooting, either press the button or press the shutter button halfway down.

To turn off the camera

Press the **ON/OFF** button again.

Shooting movies

- 1 Press the button to start recording.**

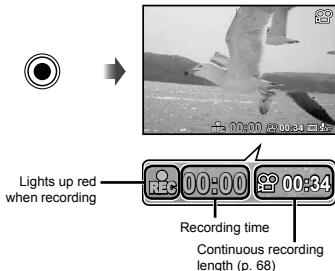

- ! The effects of the set shooting mode can be used when shooting movies. When the set shooting mode is **BEAUTY**, **SCN** (some modes), **MAGIC** (some modes) or shooting is performed in **P** mode.
- ! Sound will also be recorded.

- 2 Press the button again to stop recording.**

Using the zoom

Pressing the zoom lever adjusts the shooting range.

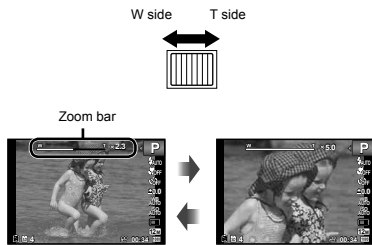

- ! Optical zoom: 5×
- Super-resolution zoom: 2×
- Digital zoom: 4×

To take larger images [Super-Res Zoom] (p. 39), [Digital Zoom] (p. 37)

- ! The type and amount of zoom can be identified from the appearance of the zoom bar. The display differs depending on the options selected for [Super-Res Zoom] (p. 39), [Digital Zoom] (p. 37) and [Image Size] (p. 33).

Super-resolution zoom	Digital zoom	Image size	Zoom bar
Off	Off	12M	<p>Optical zoom</p>
		Other	<p>+1</p>
On	Off	12M	<p>Super-resolution zoom</p>
		Other	<p>+1</p>
Off	On	12M	<p>Digital zoom</p>
		Other	<p>+1</p>
On	On	12M	<p>Super-resolution zoom Digital zoom</p>
		Other	<p>Digital zoom</p>

*1 Due to increased processing of the pixel counts, the image quality will not degrade. The magnification ratio changes depending on the image size setting.

- ! Photographs taken with the zoom bar displayed in red may appear "grainy".

Using the flash

The flash functions can be selected to best match the shooting conditions.

1 Select the flash option in the function menu.

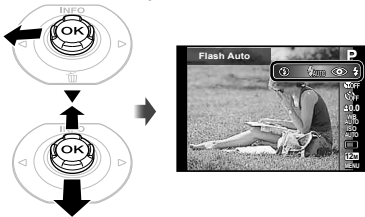

2 Use \triangleleft \triangleright to select the setting option, and press the \odot button to set.

Option	Description
Flash Auto	The flash fires automatically in low-light or backlight conditions.
Redeye	Pre-flashes are emitted to reduce the occurrence of red eye in your photos.
Fill In	The flash fires regardless of the available light.
Flash Off	The flash does not fire.

Changing the shooting information display

The display of the screen information can be changed to best match the situation, for example, the need for a clear view of the screen or for making a precise composition by using the grid display.

1 Press Δ (INFO).

- The displayed shooting information changes in the order shown below each time the button is pressed. "Shooting mode display" (p. 4)

Normal



No information



Detailed



Reading a histogram

If the peak fills too much of the frame, the image will appear mostly white.

If the peak fills too much of the frame, the image will appear mostly black.



The green section shows luminance distribution within the screen's center.

Viewing images

1 Press the button.

Number of frames/
Total number of images





Playback image

- ! Pictures taken using **BEAUTY** mode are displayed as a group. Turn the zoom lever to the T side to play back the image in the group.

2 Use to select an image.





- ! Hold  to fast forward and hold  to reverse.
- ! The display size of the images can be changed. "Index view and close-up view" (p. 22)

To play sound recordings

To play sound recorded with an image, select the image and press the  button.



During audio playback

- ! Press   to adjust volume.

To play back movies









Select a movie, and press the  button.



Movie



During playback

Pausing and restarting playback	Press the  button to pause playback. During pause, fast forward or reverse, press the  button to restart playback.
Fast forward	Press  to fast forward. Press  again to increase the fast forward speed.
Rewind	Press  to rewind. The speed at which the recording rewinds increases each time  is pressed.
Adjusting the volume	Use   to adjust the volume.

Operations while playback is paused

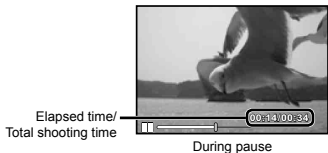

Cueing	Use Δ to display the first frame and press ∇ to display the last frame.
Advancing and rewinding one frame at a time	Press \triangleright or \triangleleft to advance or rewind one frame at a time. Hold \triangleright or \triangleleft pressed for continuous advance or rewind.
Resuming playback	Press the \odot button to resume playback.

To stop movie playback

Press the **MENU** button.

Erasing images during playback (Single image erase)

- 1 Display the image you want to erase and press ∇ (W).



- 2 Press Δ ∇ to select [Erase], and press the \odot button.

! Multiple images or all images can be erased at a time (p. 43).

Index view and close-up view

Index view enables quick selection of a desired image. Close-up view (up to 10 \times magnification) allows checking of image details.

- 1 Press the zoom lever.

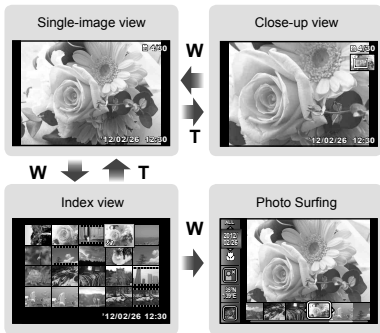

To select an image in index view

Use Δ ∇ \langle \triangleright to select an image, and press the \odot button to display the selected image in single-image view.

To scroll an image in close-up view

Use Δ ∇ \langle \triangleright to move the viewing area.

To stop photo surfing

Use Δ ∇ to select [ALL], and press the \odot button.

Changing the image information display

Shooting information settings displayed on the screen can be changed.

1 Press Δ (INFO).

- The displayed image information changes in the order shown below each time the button is pressed.

Normal



No information



Detailed



! "Reading a histogram" (p. 20)

Using the camera guide

Use the camera guide to look up camera operations.

1 Press the \odot button in the standby mode screen or the playback screen.



Submenu 2	Application
Search by purpose	Functions or operating methods can be searched.
Search for a solution	A solution can be searched when having problems during operation.
Search by situation	Search from shooting/playback scene.
Learn about the camera	Information is shown about recommended functions and basic operating methods for the camera.
Search by keyword	Search from the camera keyword.
History	Searches can be performed from the search history.

2 Use Δ ∇ \langle \triangleright to select the desired item, and press the \odot button.

- Follow the on-screen instructions to search the desired contents.

Using Shooting Modes

To change the shooting mode

- ! The shooting mode (P, iAUTO, BEAUTY, SCN, MAGIC, ) can be changed with using the function menu. "Using the Menu" (p. 8)

Shooting with automatic settings (iAUTO mode)

The camera will automatically select the optimal shooting mode for the scene. The shooting condition is decided by the camera and settings cannot be changed, excepting some functions.

1 Set the shooting mode to iAUTO.

The icon changes depending on the scene that the camera automatically selects

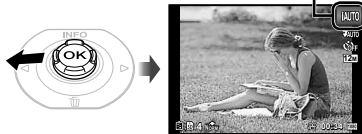

- ! In some cases, the camera may not select the desired shooting mode.

- ! When the camera cannot identify the optimal mode, P mode will be selected.

Shooting with Beauty Fix effects (BEAUTY mode)

- ! Depending on the picture, the editing may not be effective.

1 Set the shooting mode to BEAUTY.

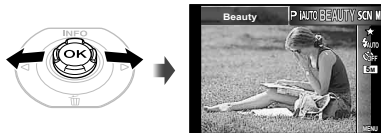

2 Press ∇ to go to the submenu.



3 Use \triangleleft \triangleright to select the retouching setting, and press the \odot button to set.

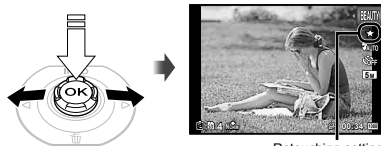

Retouching setting

- [Set 1], [Set 2] or [Set 3] retouches the image according to the Beauty Settings. [Beauty Settings] (p. 52)

4 Point the camera toward the subject. Check the frame appearing around the face detected by the camera, and then press the shutter button to take the picture.

- ! The unedited image and edited image are both saved.
- ! If the image cannot be retouched, only the unedited image is saved.
- ! The [Image Size] (p. 33) of the retouched image is limited to [5M] or lower.

5 Select [OK] or [Beauty Fix] on the review screen, and press the \odot button to save or to retouch the image additionally.



- Beauty Fix

- 1 Use Δ ∇ \triangleleft \triangleright to select a retouching item, and press the \odot button.

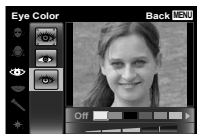

- 2 Check the retouched effects on the review screen, then press the \odot button to start the retouch process and save.
- Settings for Beauty Fix can be registered.

Using the best mode for the shooting scene (SCN mode)

1 Set the shooting mode to SCN.

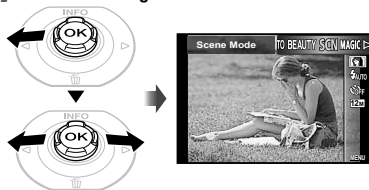

2 Press ∇ to go to the submenu.

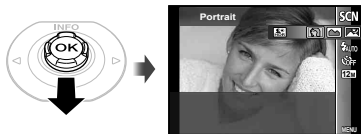

- 3** Use **<>** to select the mode and then press the **OK** button to set.

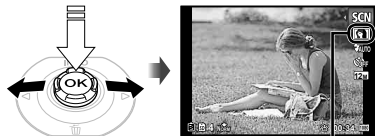

Icon indicating the scene mode that is set

- !** In **SCN** modes, the optimum shooting settings are pre-programmed for specific shooting scenes. Functions may be limited in some modes.

Option	Application
Portrait / Landscape / Night Scene ¹ / Night+Portrait ¹ / Sport / Indoor / Candle ¹ / Self Portrait / Sunset ¹ / Fireworks ¹ / Cuisine / Documents / Beach & Snow / Snapshot / Wide1 ² / Wide2 ² / Macro ³ / Pet Mode - Cat / Pet Mode - Dog / Snow ² / 3D 3D Photo / Backlight HDR ³	The camera takes a picture using the optimum settings for the scene conditions.

¹ When the subject is dark or when taking fireworks, noise reduction is automatically activated. This approximately doubles the shooting time during which no other pictures can be taken.

² TG-820 only

³ When set to **[Backlight HDR]**, **[Image Size]** (p. 33) is limited to **[5m]** or lower. This is recommended for shooting a fixed subject.

To take underwater photos

Select **[Snapshot]**, **[Wide1]**¹, **[Wide2]**^{1,2}, or **[Macro]**¹.

¹ TG-820 only

² When set to **[Wide2]**, the focus distance is automatically fixed to approx. 5.0 m (16.4 ft.).

- !** "Important information about water and shock resistant features" (p. 68)

To lock the focus distance for underwater shoots (AF lock)

When **[Snapshot]**, **[Wide1]**¹, or **[Macro]**¹ is selected, press the **OK** button.

¹ TG-820 only

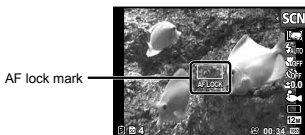

- !** To cancel, press the **OK** button again to clear the AF lock mark.

Shooting 3D images

In this mode, 3D images are shot for viewing on 3D-compatible display devices.

- !** Images shot in 3D mode cannot be displayed in 3D on this camera's monitor.

- 1** Use **<>** to select **[Auto]** or **[Manual]** and then press the **OK** button to set.

Submenu 1	Description
Auto	The user only composes the shots so that the target marks and pointers overlap, and the camera automatically releases the shutter.
Manual	After shooting the first frame, move the camera to overlap the subject with the image in the monitor. Then manually release the shutter.

- ❗ Depending on the subject or the situation (if the distance between the camera and subject is too short), the image may not look 3D.
- ❗ The 3D viewing angle varies depending on the subject, etc.
- ❗ To exit 3D shooting mode without saving an image, press the **MENU** button.
- ❗ The [Image Size] (p. 33) is fixed to [16:9S].
- ❗ The zoom ratio is fixed.
- ❗ The focus, exposure and the white balance are fixed when the first image is taken.
- ❗ The flash is fixed to [Flash Off].

Shooting with special effects (MAGIC mode)

To add expression to your photo, select the desired special effect.

1 Set the shooting mode to MAGIC.

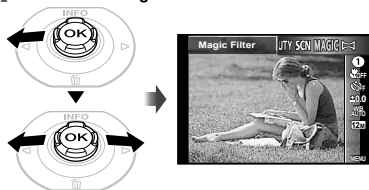

2 Press ∇ to go to the submenu.

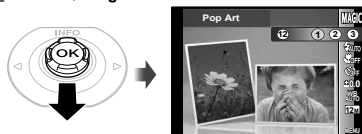

3 Use \triangleleft and \triangleright to select the desired effect and then press the **OK** button to set.

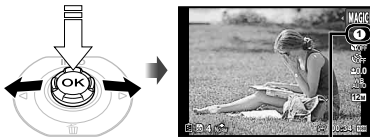

Icon indicating **MAGIC** mode that is set

Shooting mode	Option
Magic Filter	1 Pop Art
	2 Pin Hole ¹
	3 Fish Eye
	4 Drawing ^{1,2}
	5 Soft Focus ¹
	6 Punk
	7 Sparkle ¹
	8 Watercolor ¹
	9 Reflection
	10 Miniature
	11 Fragmented
	12 Dramatic

¹ The [Image Size] (p. 33) of the retouched image is limited to [5M] or lower.

² Two images are saved, an unmodified image and an image to which the effect has been applied.

! In **MAGIC** mode, the optimum shooting settings are pre-programmed for each scene effect. For this reason, some settings cannot be changed in some modes.

! The selected effect is applied to the movie. The effect may not be applied depending on the shooting mode.

Creating panoramic images (M mode)

1 Set the shooting mode to M.

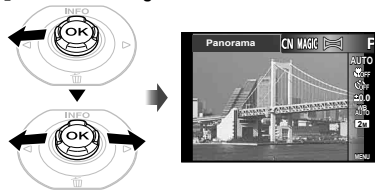

2 Press ∇ to go to the submenu.

3 Use \triangleleft and \triangleright to select the desired mode and then press the \odot button to set.

Submenu 1	Application
Auto	Three frames are taken and combined by the camera. The user only composes the shots so that the target marks and pointers overlap, and the camera automatically releases the shutter.
Manual	Three frames are taken and combined by the camera. The user composes the shots using the guide frame and manually releases the shutter.
PC	The frames that were taken are combined into a panorama image using the PC software.

! For details on installing the PC software, see "Installing the PC software and registering user" (p. 14).

! When set to [Auto] or [Manual], [Image Size] (p. 33) is fixed to 2MB or equivalent.

! The focus, exposure, zoom position (p. 19), and white balance (p. 31) are locked at the first frame.

! The flash (p. 20) is fixed to OFF (Flash Off) mode.

Taking pictures with [Auto]

- Press the shutter button to take the first frame.
- Move the camera slightly in the direction of the second frame.



Screen when combining images from left to right

- Move the camera slowly while keeping it straight, and stop the camera where the pointer and target mark overlap.

- The camera releases the shutter automatically.



- To combine only two pictures, press the **OK** button before taking a third frame.

- Repeat Step ③ to take a third frame.

- After the third frame is taken, the camera automatically processes the frames and the combined panorama image is displayed.

- To exit the panorama function without saving an image, press the **MENU** button.

- If the shutter does not automatically release, try [Manual] or [PC].

Taking pictures with [Manual]

- Use $\Delta \nabla \triangleleft \triangleright$ to specify at which edge the next picture is to be connected.

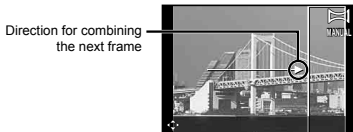

- Press the shutter button to take the first frame. The white-boxed part of the first frame is displayed on joint area 1.



- Compose the next shot so that joint area 1 overlaps joint area 2.

- Press the shutter button to take the next shot.

- Press the **OK** button to combine just 2 frames.

- Repeat steps ③ and ④ to take a third frame.

- After the third frame is taken, the camera automatically processes the frames and the combined panorama image is displayed.

- To exit the panorama function without saving an image, press the **MENU** button.

Taking pictures with [PC]

- Use $\Delta \nabla \triangleleft \triangleright$ to select the direction that the frames are combined.

- Press the shutter button to take the first frame, and then point the camera for the second frame. The shooting procedure is same as that of [Manual].

- Panorama shooting is possible for up to 10 frames.

- Repeat Step ② until the number of desired frames is taken, and then press the **OK** button or **MENU** button when finished.

- Refer to the PC software help guide for details on how to make panorama images.

Using Shooting Functions

! "Using the Menu" (p. 8)

Shooting closeups (Macro shooting)

This function enables the camera to focus and shoot subjects at close distances.

1 Select the macro option in the function menu.

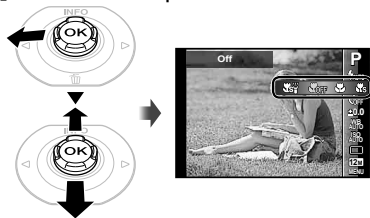

2 Use \leftarrow and \rightarrow to select the setting option, and press the OK button to set.

Option	Description
Off	Macro mode is deactivated.
Macro	You can shoot the image at a closer range. 20 cm (7.9 in.) ¹ 50 cm (19.7 in.) ²
Super Macro ³	This enables shooting as close as 3 cm/1.2 in. to the subject. Subjects at 60 cm/23.6 in. or farther cannot be brought into focus.
S-Macro LED ^{3,4}	The LED illuminator lights the area 7 to 20 cm (2.8 to 7.9 in.) from the lens, while the shutter button is pressed halfway down.

¹ When the zoom is at the widest (W) position.

² When the zoom is at the most telephoto (T) position.

³ The zoom is automatically fixed.

⁴ ISO sensitivity (p. 32) is automatically fixed to [ISO Auto].

! The flash (p. 20) and zoom (p. 19) cannot be set when [Super Macro] or [S-Macro LED] is selected.

Using the self-timer

After the shutter button is pressed all the way down, the picture is taken after a short delay.

1 Select the self-timer option in the function menu.

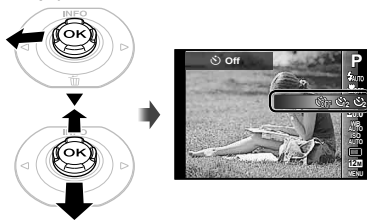

- 2** Use \triangleleft \triangleright to select the setting option, and press the \odot button to set.

Option	Description
\odot Off	The self-timer is deactivated.
\odot 12 sec	The self-timer lamp turns on for approx. 10 seconds, then blinks for approx. 2 seconds, and then the picture is taken.
\odot 2 sec	The self-timer lamp blinks for approx. 2 seconds, then the picture is taken.
\odot Auto Release ^{**}	When your pet (cat or dog) turns its head towards the camera, its face is recognized and the picture is taken automatically.

^{**} [Auto Release] is displayed only when the **SCN** mode is \odot or \odot .

To cancel the self-timer after it starts

Press the **MENU** button.

Adjusting the brightness (Exposure compensation)

The standard brightness (appropriate exposure) set by the camera based on the shooting mode (except for **IAUTO**) can be adjusted brighter or darker to obtain a desired shot.

- 1** Select the exposure compensation option in the function menu.

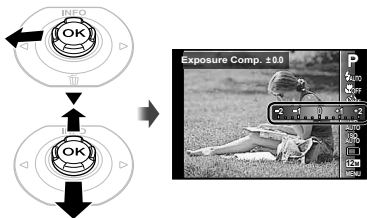

- 2** Use \triangleleft \triangleright to select the desired brightness, and press the \odot button.





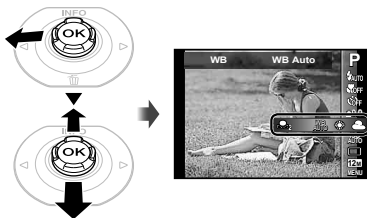

Adjusting to a natural color scheme (White balance)

For more natural coloring, choose a white balance option suited to the scene.

- 1** Select the white balance option in the function menu.



2 Use \triangleleft \triangleright to select the setting option, and press the \odot button to set.

Option	Description
WB Auto	The camera automatically adjusts the white balance according to the shooting scene.
	For shooting outdoors under a clear sky.
	For shooting outdoors under a cloudy sky.
	For shooting under tungsten lighting.
	For shooting under white fluorescent lighting.
	For underwater shooting.
	For setting the subtle shades of color that cannot be adjusted by Auto, Sunny, Cloudy, Incandescent, or Fluorescent.
	

- When the $[W1]$ or $[W2]$ whose white balance has already been registered is selected in Step ②, new white balance will be registered.

! When the white area is not large enough or when the color is too bright, too dark, or loud, the white balance cannot be registered. Return to Step ②. Or, set the other white balance.

Selecting the ISO sensitivity

1 Select the ISO setting option in the function menu.

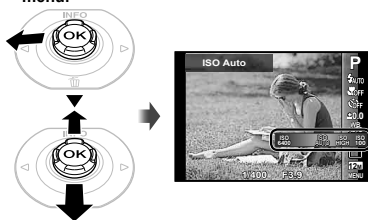

Using the one touch white balance

- Select the white balance option in the function menu.
- Use \triangleleft \triangleright to select $[W1]$ or $[W2]$, and face the camera toward white paper.
 - Set the paper to fill the entire screen, and make sure that there is no shadow area.
 - Perform this procedure under the light where the pictures are actually taken.
- Press the **MENU** button.
 - The camera releases the shutter and the white balance is registered.
 - The registered white balance is stored in the camera. The data will not be cleared by turning off the power.

2 Use \triangleleft \triangleright to select the setting option, and press the \odot button to set.

Option	Description
ISO Auto	The camera automatically adjusts the sensitivity according to the shooting scene.
High ISO Auto	The camera uses a higher sensitivity compared to [ISO Auto] to minimize blur caused by a moving subject or by camera shake.
Value	The ISO sensitivity is fixed to the selected value.

- ! In the ISO setting, although smaller values result in less sensitivity, sharp images can be taken under fully lit conditions. Larger values result in higher sensitivity, and images can be taken at fast shutter speeds even under low light conditions. However, high sensitivity introduces noise into the resulting picture, which may give it a grainy appearance.

Sequential shooting (Drive)

Pictures are taken sequentially while the shutter button is held down.

- 1 Select the drive option in the function menu.

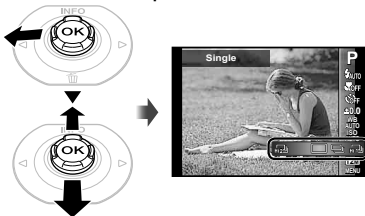

- 2 Use \leftarrow and \rightarrow to select the setting option, and press the \odot button to set.

Option	Description
	One frame is shot each time the shutter button is pressed.
	The images are taken sequentially while holding down the shutter for up to 100 frames.
	The camera takes sequential shots at approximately 15 frames/sec.
	The camera takes sequential shots at approximately 60 frames/sec.

- 1 The shooting speed varies depending on the settings for [Image Size] (p. 33) or [Compression] (p. 36).

- ! When set to $\left[\text{Hi } 15 \right]$ or $\left[\text{Hi } 60 \right]$, [Image Size] is limited to $\left[\text{3M} \right]$ or lower, and the ISO sensitivity is fixed to [ISO Auto].
- ! When set to $\left[\text{Off} \right]$, the flash (p. 20) cannot be set to [Redeye]. When set to other than $\left[\text{Off} \right]$ or $\left[\text{Off} \right]$, the flash is fixed to $\left[\text{Flash Off} \right]$.
- ! When set to $\left[\text{Hi } 15 \right]$ or $\left[\text{Hi } 60 \right]$, the digital zoom (p. 37) is not available.
- ! With settings other than $\left[\text{Off} \right]$, the focus, exposure and the white balance are fixed when the first frame is shot.

Selecting the image size for still images (Image Size)

- 1 Select the image size option in the function menu.

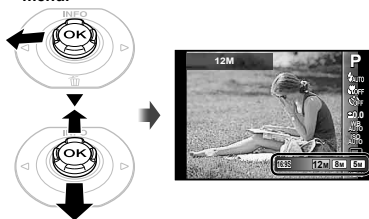

2 Use **<|>** to select the setting option, and press the **(M)** button to set.

Option	Description
12M (3968×2976)	Suitable for printing pictures over A3 (11×17 in.).
8M (3264×2448)	Suitable for printing pictures up to A3 (11×17 in.).
5M (2560×1920)	Suitable for printing pictures at A4 (8.5×11 in.).
3M (2048×1536)	Suitable for printing pictures up to A4 size (8.5×11 in.).
2M (1600×1200)	Suitable for printing pictures at A5 (5×7 in.).
1M (1280×960)	Suitable for printing pictures at postcard size.
VGA (640×480)	Suitable for viewing pictures on a TV or using pictures on emails and web sites.
16:9L (3968×2232)	Suitable for playing pictures on a widescreen TV and for printing on A3 or 11"×17".
16:9S (1920×1080)	Suitable for playing pictures on a widescreen TV and for printing on A5 or 5"×7".

Using the LED illuminator

In a dark location, the LED illuminator can be used as an auxiliary light to see things or compose shots.

1 Set [LED Illuminator] (p. 53) to [On].

2 Press and hold the **(Q)** button down until the LED illuminator lights up.

- If you perform an operation when the LED illuminator is on, it will illuminate up to approx. 90 seconds.

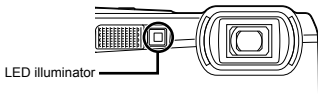

- ! The LED illuminator turns off if no operation is performed for approx. 30 seconds.
- ! Even when the camera's power is turned off, if the **(Q)** button is pressed until the LED illuminator lights up, it lights for 30 seconds.

To turn the LED illuminator off

Press and hold the **(Q)** button down, until the LED illuminator turns off.

Using the playback functions

Playing back panorama images

Panorama images that were combined together using [Auto] or [Manual] can be scrolled for viewing.

! "Creating panoramic images (M mode)" (p. 28)

1 Select a panorama image during playback.

! "Viewing images" (p. 21)



2 Press the (OK) button.



Viewing area

To control panorama image playback

Zoom in/Zoom out: Press the (OK) button to pause playback. Then press the zoom lever to enlarge/shrink the image.

Playback direction: Press the (OK) button to pause playback. Then press $\Delta \nabla \langle \rangle$ to scroll the image in the direction of the pressed button.

Pause: Press the (OK) button.

Restart scrolling: Press the (OK) button.

Stop playback: Press the MENU button.

Playing back 3D images

3D images shot with this camera can be played back on 3D-compatible devices connected to this camera using an HDMI cable (sold separately).

! "Shooting 3D images" (p. 26)

! When playing back 3D images, read the warnings in the instruction manual for the 3D-compatible devices carefully.

1 Connect the 3D-compatible device and camera using the HDMI cable.

! For the connection and setting method, see "Connection via HDMI cable" (p. 49)

2 Use $\Delta \nabla$ to select [3D Show] and then press the (OK) button.

3 Use $\Delta \nabla \langle \rangle$ to select the 3D image to play back and then press the (OK) button.

! To start a slideshow, press the MENU button. To stop the slideshow, press the MENU or (OK) button.



! 3D images are composed of JPEG files and MPO files. If any files are deleted on a computer, playback of 3D images may not be possible.

Menus for Shooting Functions

- ! The default settings of the function are highlighted in .
- ! For information on using the menus, see "Using the Menu" (p. 8).

Restoring the shooting functions to the default settings [Reset]

 (Camera Menu 1) ► Reset

Submenu 2	Application
Yes	Restores the following menu functions to the default settings. <ul style="list-style-type: none">• Shooting mode (p. 24)• Flash (p. 20)• Macro (p. 30)• Self-timer (p. 30)• Exposure compensation (p. 31)• White balance (p. 31)• ISO (p. 32)• Drive (p. 33)• Image Size (still images) (p. 33)• Menu functions in   (p. 36 to 40)
No	The settings will not be changed.

Selecting the image quality for still images [Compression]

 (Camera Menu 1) ► Compression

Submenu 2	Application
Fine	Shooting at high quality.
Normal	Shooting at normal quality.

- ! "Number of storable pictures (still images)/Continuous recording length (movies) in the internal memory and cards" (p. 67, 68)

Brightening the subject against backlight [Shadow Adjust]

 (Camera Menu 1) ► Shadow Adjust

Submenu 2	Application
Auto	Automatically On when a compatible shooting mode is selected.
Off	The effect is not applied.
On	Shoot with automatic adjustment to brighten an area that has become darker.

- ! When set to [Auto] or [On], [ESP/(p. 37) is automatically fixed to [ESP].

Selecting the focusing area [AF Mode]





 (Camera Menu 1) ► AF Mode

Submenu 2	Application
Face/iESP	The camera focuses automatically. (If a face is detected, it is shown by a white frame ¹ ; when the shutter button is pressed halfway and the camera focuses, the frame turns to green ² . If no face is detected, the camera chooses a subject in the frame and focuses automatically.)
Spot	The camera focuses on the subject located within the AF target mark.
AF Tracking	The camera tracks the subject movement automatically to focus on it continuously.



¹ For some subjects, the frame may not appear or may take some time to appear.

² If the frame blinks in red, the camera cannot focus. Try refocusing on the subject.

To focus on a moving subject continuously (AF Tracking)

- Hold the camera to align the AF target mark on the subject and press the  button.
 - When the camera recognizes the subject, the AF target mark automatically tracks the subject movement to focus on it continuously.
 - To cancel the tracking, press the  button.
-  Depending on the subjects or the shooting conditions, the camera may be unable to lock the focus or fail to track the subject movement.
-  When the camera fails to track the subject movement, the AF target mark changes to red.

Selecting the method for measuring the brightness [ESP/

 (Camera Menu 1) ► ESP/





Submenu 2	Application
ESP	Shoots to obtain a balanced brightness over the entire screen (Meters the brightness at the center and surrounding areas of the screen separately).
 (spot)	Shoots the subject at the center during backlighting (Meters the brightness at the center of the screen).

 When set to [ESP], the center may appear dark when shooting against strong backlighting.

Shooting at higher magnifications than optical zoom [Digital Zoom]

 (Camera Menu 1) ► Digital Zoom

Submenu 2	Application
Off	Disable digital zoom.
On	Enable digital zoom.

-  [Digital Zoom] is not available when  Super Macro or  S-Macro LED] (p. 30) is selected.
-  The option selected for [Digital Zoom] affects the appearance of the zoom bar. "To take larger images" (p. 19)





Reducing the blur caused by the camera shake when shooting [Image Stabilizer] (still images)/ [IS Movie Mode] (movies)

 (Camera Menu 1)

▶ Image Stabilizer (still images)/

 (Movie Menu) ▶ IS Movie Mode (movies)

Submenu 2	Application
Off	The image stabilizer is deactivated. This is recommended for shooting when the camera is fixed in place on a tripod or other stable surface.
On	The image stabilizer is activated.

-  Default setting [Image Stabilizer] [On], [IS Movie Mode] [Off]
-  There may be a noise coming from inside the camera when the shutter button is pressed with [Image Stabilizer] (still images) set to [On].
-  Images may not be stabilized if camera shake is too severe.
-  When the shutter speed is extremely slow, such as when taking pictures at night, [Image Stabilizer] (still images) may not be as effective.

Viewing the image immediately after shooting [Rec View]



 (Camera Menu 2) ▶ Rec View

Submenu 2	Application
Off	The image being recorded is not displayed. This allows the user to prepare for the next shot while following the subject in the monitor after shooting.
On	The image being recorded is displayed. This allows the user to make a brief check of the image that was just taken.

Automatically rotating images shot with the camera in a vertical position during playback [Pic Orientation]

(TG-820 only)

 (Camera Menu 2) ▶ Pic Orientation

-  During shooting, the [] (p. 43) setting on the playback menu is set automatically.
-  This function may not work properly if the camera is facing up or down during shooting.

Submenu 2	Application
Off	Information about the vertical/horizontal orientation of the camera during shooting is not recorded with images. Images shot with the camera in a vertical position are not rotated during playback.
On	Information about the vertical/horizontal orientation of the camera during shooting is recorded with images. Images are automatically rotated during playback.

Displaying icon guides [Icon Guide]

 (Camera Menu 2) ► Icon Guide



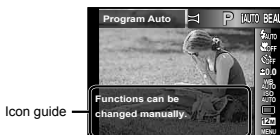

Submenu 2	Application
Off	No icon guide is displayed.
On	The explanation of the selected icon will be displayed when a shooting mode or function menu icon is selected (position the cursor on the icon for a while to display the explanation).



Imprinting the date of recording [Date Stamp]

 (Camera Menu 2) ► Date Stamp

Submenu 2	Application
Off	Do not imprint the date.
On	Stamp new photographs with the date of recording.

-  When the date and time are not set, [Date Stamp] cannot be set.
"Language, date, time, and time zone" (p. 16)
-  The date stamp can not be deleted.
-  [Date Stamp] is not available in [Panorama] (p. 28) or [3D Photo] (p. 25) mode.
-  When drive settings (p. 33) are set to other than , [Date Stamp] cannot be set.

Shooting larger pictures than when using optical zoom with low degrading of image quality [Super-Res Zoom]

 (Camera Menu 2) ► Super-Res Zoom

Submenu 2	Application
Off	Disable super-resolution zoom.
On	Enable super-resolution zoom.

-  [Super-Res Zoom] is available only when [Image Size] (p. 33) is set to **[12M]**.



Selecting the image size for movies [Image Size]

 (Movie Menu) ► Image Size

Submenu 2	Application
1080p 720p VGA (640×480)	Select the image quality based on the image size and frame rate.

 "Number of storable pictures (still images)/Continuous recording length (movies) in the internal memory and cards" (p. 67, 68)

Recording sound when shooting movies [

 (Movie Menu) ► 

Submenu 2	Application
Off	No sound is recorded.
On	Sound is recorded.

Reduce wind noise in the recorded sound when recording movie [Wind Noise Reduction]

 (Movie Menu) ► Wind Noise Reduction

Submenu 2	Application
Off	Disable Wind Noise Reduction.
On	Uses Wind Noise Reduction.

Menus for Playback, Editing, and Printing Functions

- ! The default settings of the function are highlighted in .
- ! Data must be created with the ib (PC software) before using some functions.
- ! Refer to the ib (PC software) help guide for details on how to use the ib (PC software).
- ! For details on installing the ib (PC software), see "Installing the PC software and registering user" (p. 14).

Playing back pictures automatically [Slideshow]

▶ (Playback Menu) ▶ Slideshow

Submenu 2	Submenu 3	Application
Slide	All/Event/ Collection ^{*1}	Selects the content to be included in the slideshow.
BGM	Off/Cosmic/ Breeze/ Mellow/ Dreamy/ Urban	Selects the background music options.
Type	Normal/Fader/ Zoom	Selects the type of transition effect used between slides.
Start	—	Starts the slideshow.

^{*1} The [Collection] that has been created with the ib (PC software) and imported back from a computer can play back.

- ! During a slideshow, press ▶ to advance one frame, ◀ to go back one frame.

Searching for images and playing back the related images [Photo Surfing]

▶ (Playback Menu) ▶ Photo Surfing

In [Photo Surfing], images can be searched and related images can be played back by selecting the related items.

To start [Photo Surfing]

Press the (⊞) button to start [Photo Surfing].

When a related item of the image displayed is selected with Δ ∇, images related to the item are displayed in the lower part of the monitor. Use ◀ ▶ to display an image.

To select related items that are not displayed, press the (⊞) button when selecting an item.

To stop [Photo Surfing], use Δ ∇ to select [ALL], and press the (⊞) button.

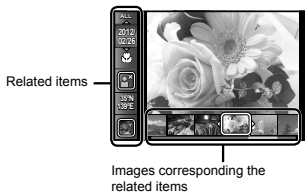

Using the ib (PC software) and importing data back to the camera

- ! Refer to the ib (PC software) help guide for details on how to use the ib (PC software).
- ! The ib (PC software) may not work properly on the pictures edited by other application software.

- ! The following [Photo Surfing] functions can be performed when data created with the ib (PC software) is imported back to the camera. Information of persons or shooting locations and new Collections can be added in the related items.

Changing the image size [📏]

[▶] (Playback Menu) ▶ Edit ▶ [📏]

Submenu 3	Application
[VGA] 640×480	This saves a high-resolution image as a separate image with a smaller size for use in e-mail attachments and other applications.
[VGA] 320×240	

- Use <▶> to select an image.
- Use Δ ▽ to select an image size and press the Ⓜ button.
 - The resized image is saved as a separate image.

Cropping image [✂]

[▶] (Playback Menu) ▶ Edit ▶ [✂]

- Use <▶> to select an image, and press the Ⓜ button.
- Use the zoom lever to select the size of the cropping frame, and use Δ ▽ <▶> to move the frame.



- Press the Ⓜ button after you have selected the area to trim.
 - The edited image is saved as a separate image.

Adding sound to still images [🔊]

[▶] (Playback Menu) ▶ Edit ▶ [🔊]

- Use <▶> to select an image.
- Aim the microphone toward the sound source.

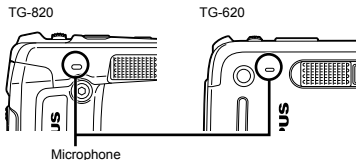

- Press the Ⓜ button.
 - Recording starts.
 - The camera adds (records) sound for approx. 4 seconds while playing back the image.

Retouching faces on still images [Beauty Fix]

[▶] (Playback Menu) ▶ Edit ▶ Beauty Fix

- ! Depending on the picture, the editing may not be effective.
- Use <▶> to select an image, and press the Ⓜ button.
 - Use Δ ▽ to select a retouching item, and press the Ⓜ button.
 - Select [OK] or [Beauty Fix] on the review screen, and press the Ⓜ button to save or to retouch the image additionally.

- The retouched image is saved as a separate image.



- ❗ The [Image Size] (p. 33) of the retouched image is limited to [5M] or lower.

Beauty Fix

- ① Select a retouching item, and press the \odot button.

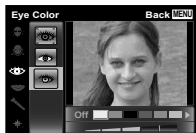

- ② Press the \odot button on the review screen.

Brightening areas that are dark due to backlight or other reasons [Shadow Adj]

\square (Playback Menu) ▶ Edit ▶ Shadow Adj

- ① Use $\triangleleft \triangleright$ to select an image, and press the \odot button.
- The edited image is saved as a separate image.
- ❗ Depending on the picture, the editing may not be effective.
- ❗ The retouching process may lower the image resolution.

Retouching red eyes in flash shooting [Redeye Fix]

\square (Playback Menu) ▶ Edit ▶ Redeye Fix

- ① Use $\triangleleft \triangleright$ to select an image, and press the \odot button.
- The edited image is saved as a separate image.
- ❗ Depending on the picture, the editing may not be effective.
- ❗ The retouching process may lower the image resolution.

Rotating images [\curvearrowright]

\square (Playback Menu) ▶ Edit ▶ \curvearrowright

- ① Use $\triangleleft \triangleright$ to select an image.
- ② Press the \odot button to rotate the image.
- ③ If necessary, repeat Steps ① and ② to make settings for other images, and press the **MENU** button.
- ❗ The new picture orientations will be saved even after the power is turned off.

Erasing images [Erase]

\square (Playback Menu) ▶ Erase

Submenu 2	Application
All Erase	All images in the internal memory or card will be erased.
Sel. Image	Images are individually selected and erased.
Erase	Deletes the image displayed.

- ❗ When erasing pictures in the internal memory, do not insert the card into the camera.
- ❗ Protected images cannot be erased.

To individually select and erase images

[Sel. Image]

- 1 Use $\Delta \nabla$ to select [Sel. Image], and press the \odot button.
- 2 Use $\triangleleft \triangleright$ to select the image to be erased, and press the \odot button to add a \checkmark mark to the image.
 - Press the zoom lever to the W end to display an index view. Images can be quickly selected using the $\Delta \nabla \triangleleft \triangleright$ buttons. Press to the T end to return to the single frame display.

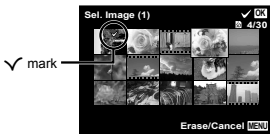

- 3 Repeat Step 2 to select the images to be erased, and then press the **MENU** button to erase the selected images.
- 4 Use $\Delta \nabla$ to select [Yes], and press the \odot button.
 - The images with a \checkmark mark are erased.

To erase all images [All Erase]

- 1 Use $\Delta \nabla$ to select [All Erase], and press the \odot button.
- 2 Use $\Delta \nabla$ to select [Yes], and press the \odot button.

Saving print settings to the image data [Print Order]

\blacktriangleright (Playback Menu) \blacktriangleright Print Order

- ! "Print reservations (DPOF)" (p. 57)
- ! Print reservation can be set only for still images that are recorded to the card.

Protecting images [5]

\blacktriangleright (Playback Menu) \blacktriangleright 5

- ! Protected images cannot be erased by [Erase] (p. 22, 43), [Sel. Image] (p. 44), or [All Erase] (p. 44), but all images are erased by [Memory Format]/[Format] (p. 45).
- 1 Use $\triangleleft \triangleright$ to select an image.
 - 2 Press the \odot button.
 - Press the \odot button again to cancel the settings.
 - 3 If necessary, repeat Steps 1 and 2 to protect other images, and press the **MENU** button.

Setting images to upload to Internet using OLYMPUS Viewer 2 [Upload Order]

\blacktriangleright (Playback Menu) \blacktriangleright Upload Order



- 1 Use $\triangleleft \triangleright$ to select an image.
 - 2 Press the \odot button.
 - Press the \odot button again to cancel the settings.
 - 3 If necessary, repeat Steps 1 and 2 to make settings for other images, and press the **MENU** button.
- ! Only JPEG files can be ordered.
 - ! For details on uploading images, refer to OLYMPUS Viewer 2 "Help".

Menus for Other Camera Settings

 The default settings of the function are highlighted in .

Erasing data completely **[Memory Format]/[Format]**

 (Settings Menu 1) ► Memory Format/Format

-  Before formatting, check that no important data is left in the internal memory or card.
-  Cards must be formatted with this camera before first use or after being used with other cameras or computers.
-  Be sure to remove the card before formatting the internal memory.

Submenu 2	Application
Yes	Completely erases the image data in the internal memory or card (including protected images).
No	Cancels formatting.

Copying images in the internal memory to the card **[Backup]**





 (Settings Menu 1) ► Backup

Submenu 2	Application
Yes	Backs up image data in the internal memory to the card.
No	Cancels the backup.

Using an Eye-Fi card **[Eye-Fi]**

 (Settings Menu 1) ► Eye-Fi

Submenu 2	Application
All	Transfers all images.
Sel. Image	Transfers only selected image.
Off	Disable Eye-Fi communication.

-  When using an Eye-Fi card, read the Eye-Fi card instruction manual carefully, and comply with the instructions.
-  Use the Eye-Fi card in compliance with the laws and regulations of the country where the camera is used.
-  In locations such as on an airplane, where the Eye-Fi communication is prohibited, remove the Eye-Fi card from the camera, or set [Eye-Fi] to [Off].
-  This camera does not support the Eye-Fi card's Endless mode.

Selecting a method for connecting the camera to other devices [USB Connection]

f (Settings Menu 1) ▶ USB Connection

Submenu 2	Application
Auto	When the camera is connected to another device, the settings selection screen is displayed.
Storage	Select when connecting the camera to a computer via a storage device.
MTP	Select when transferring images without using the supplied [ib] (PC software) on Windows Vista/Windows 7.
Print	Select when connecting to a PictBridge-compatible printer.

System requirements

Windows : Windows XP Home Edition/
Professional (SP1 or later)/
Vista/Windows 7

Macintosh : Mac OS X v10.3 or later

! When using another system other than Windows XP (SP2 or later)/Windows Vista/Windows 7, set to [Storage].

! Even if a computer has USB ports, proper operation is not guaranteed in the following cases:

- Computers with USB ports installed using an expansion card, etc.
- Computers without a factory-installed OS and home-built computers

Turning on the camera with the button [Power On]

f (Settings Menu 1) ▶  Power On

Submenu 2	Application
No	The camera is not turned on. To turn on the camera, press the ON/OFF button.
Yes	Press and hold the  button to turn the camera on in the playback mode.

Saving the mode when the camera is turned off [Keep Settings]

f (Settings Menu 1) ▶ Keep  Settings

Submenu 2	Application
Yes	The shooting mode is saved when the camera is turned off and is reactivated the next time the camera is turned on.
No	The shooting mode is set to P mode when the camera is turned on.

Selecting the camera sound and its volume [Sound Settings]

f (Settings Menu 1) ► Sound Settings

Submenu 2	Submenu 3	Application
Sound Type	1/2/3	Selects the camera sounds (operation sounds, shutter sound, and warning sound).
Volume	0/1/2/3/4/5	Selects the operation volume of camera buttons.
 Volume	0/1/2/3/4/5	Selects the image playback volume.

Resetting the file names of pictures [File Name]

f (Settings Menu 2) ► File Name

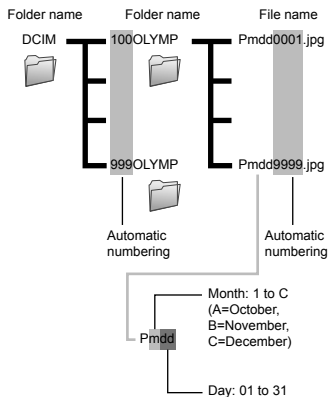

Submenu 2	Application
Reset	This resets the sequential number for the folder name and file name whenever a new card is inserted. ¹¹ This is useful when grouping images on separate cards.
Auto	Even when a new card is inserted, this continues the numbering for the folder name and file name from the previous card. This is useful for managing all image folder names and files names with sequential numbers.

¹¹ The number for the folder name is reset to 100, and the one for the file name is reset to 0001.

Adjusting the image processing function [Pixel Mapping]

f (Settings Menu 2) ▶ Pixel Mapping

- ! This function has already been adjusted at factory shipping, and no adjustment is needed right after purchase. Approximately once a year is recommended.
- ! For best results, wait at least one minute after taking or viewing pictures before performing pixel mapping. If the camera is turned off during pixel mapping, be sure to perform it again.

To adjust the image processing function

Press the  button when [Start] (Submenu 2) is displayed.

- The check and adjustment of the image processing function starts.

Playing back images on a TV [TV Out]

f (Settings Menu 2) ▶ TV Out



Submenu 2	Submenu 3	Application
NTSC/PAL	NTSC	Connecting the camera to a TV in North America, Taiwan, Korea, Japan, and so on.
	PAL	Connecting the camera to a TV in European countries, China, and so on.
HDMI Out	480p/576p 720p 1080i	Set the signal format to be given priority. If the TV setting does not match, it is changed automatically.
HDMI Control	Off	Operate with the camera.
	On	Operate with the TV remote control.

- ! The factory default settings differ according to the region where the camera is sold.

Adjusting the brightness of the monitor [!☰!]

f (Settings Menu 2) ▶ 

To adjust the monitor brightness

- Use   to adjust the brightness while viewing the screen, and then press the  button.

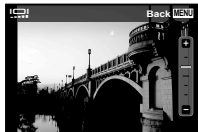

To play back camera images on a TV

- Connection via AV cable

- ① Use the camera to select the same video signal system as the one of connected TV ([NTSC]/[PAL]).
- ② Connect the TV and camera.

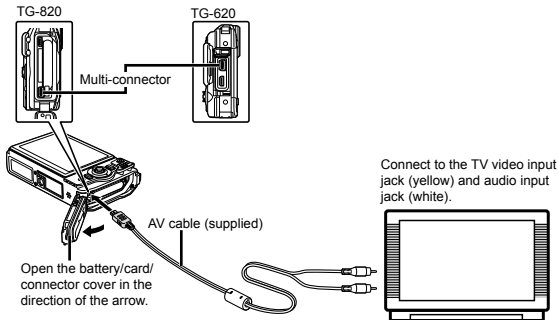

- Connection via HDMI cable

- ① On the camera, select the digital signal format that will be connected ([480p/576p]/[720p]/[1080i]).
 - ② Connect the TV and camera.
 - ③ Turn on the TV, and change "INPUT" to "VIDEO (an input jack connected to the camera)".
 - ④ Turn on the camera, and use $\Delta \nabla \langle \rangle$ to select the image for playback.
- ! The TV video signal system varies depending on the countries and regions. Before viewing camera images on your TV, select the video output according to your TV's video signal type.
 - ! When the camera is connected to the computer by the USB cable, do not connect the HDMI cable to the camera.

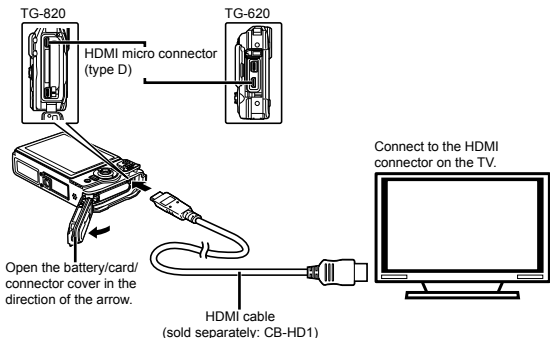

- ❗ For details on changing the input source of the TV, refer to the TV's instruction manual.
- ❗ When the camera and TV are connected by both an AV cable and an HDMI cable, the HDMI cable will take priority.
- ❗ Depending on the TV's settings, the displayed images and information may become cropped.

To operate images with the TV remote control

- ① Set [HDMI Control] to [On], and turn off the camera.
 - ② Connect the camera and TV with an HDMI cable. "Connection via HDMI cable" (p. 49)
 - ③ First turn on the TV, and then turn on the camera.
 - Operate by following the operation guide that is displayed on the TV.
- ❗ With some TVs, operations cannot be performed with the TV remote control even though the operation guide is displayed on the screen.
 - ❗ If operations cannot be performed with the TV remote control, set [HDMI Control] to [Off] and operate using the camera.

Saving battery power between shots [Power Save]

(Settings Menu 2) ► Power Save

Submenu 2	Application
Off	Cancels [Power Save].
On	When the camera is not being used for approx. 10 seconds, the monitor automatically turns off to save battery power.

To resume standby mode

Press any button.

Changing the display language []

(Settings Menu 2) ►

Submenu 2	Application
Languages	The language for the menus and error messages displayed on the monitor is selected.

Setting the date and time []

(Settings Menu 2) ►

"Language, date, time, and time zone" (p. 16).

To check the date and time

Press the button while the camera is turned off. The current time is displayed for approx. 3 seconds.

Choosing home and alternate time zones [World Time]

(Settings Menu 3) ► World Time

You will not be able to select a time zone using [World Time] if the camera clock has not first been set using [].

Submenu 2	Submenu 3	Application
Home/ Alternate		The time in the home time zone (the time zone selected for in submenu 2).
		The time in the travel destination time zone (the time zone selected for in submenu 2).
¹	—	Select the home time zone ().
^{1, 2}	—	Select the travel destination time zone ().

¹ In areas where daylight saving time is in effect, use to turn daylight saving time ([Summer]) on.

² When you select a time zone, the camera automatically calculates the time difference between the selected zone and the home time zone () to display the time in the travel destination time zone ().

Restoring data in the camera [Reset Database]

f (Settings Menu 3) ▶ Reset Database

- ! Playback will become available by performing [Reset Database] when the Photo surfing function is not activated properly. However, data such as collections and other groups created with the ib (PC software) is deleted from the database in the camera. Import the data back into the camera from a computer to playback the data created with the ib (PC software).

Registering the settings for Beauty Fix [Beauty Settings]

f (Settings Menu 3) ▶ Beauty Settings

- ! Depending on the picture, the editing may not be effective.
- Use Δ ∇ to select a retouching setting, and press the \odot button.
 - Press the shutter button to take a portrait picture.



- ! The image is not saved.
- Select a retouching item, and press the \odot button.



- Press the \odot button on the review screen to save the image.
 - Registration is complete.

Operating the camera by tapping the body [Tap Control]

(TG-820 only)

f (Settings Menu 3) ▶ Tap Control

Submenu 2	Application
Off	Cancels [Tap Control].
On	[Tap Control] is activated.
Calibrate	Adjusts the tap strength and intervals between multiple taps on each side of the camera body. (top, left, right, & back)

Operating during shooting mode (Example: Flash mode)

- Tap the right or left side of the camera body once. Then tap the top side of the camera once.
 - The flash mode selection screen is displayed.
- Tap the right or left side of the camera body to select a function.
- Tap the back of the camera body twice to confirm your selection.



- ❗ Tap the camera firmly using the pad of your finger.
- ❗ When the camera is stabilized on a tripod for example, tap control may not work properly.
- ❗ To prevent dropping the camera when using tap control, strap the camera to your wrist.

Operating during playback mode

When switched to playback mode by tapping the top of the camera body twice, the operations below can be used.

Display next image: Tap the right side of the camera once.

Display previous image: Tap the left side of the camera once.

Fast forward and reverse: Tilt the camera to the right or the left.

Return to the shooting mode: Tap the top side of the camera twice.

Take a picture: Tap the back of the camera twice (Only for the [⊞ Snow] mode).

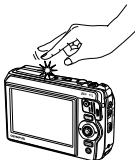

When tapping the camera's top

To adjust the tap control

- ① Select [Calibrate] in Submenu 2 and press the button.
- ② Select the part to adjust with Δ ∇ and press the button.
- ③ Select the [Str] setting with Δ ∇ and press \triangleright .
- ④ Select the [Intvl] setting with Δ ∇ and press the button.



- ❗ Check the operation of the camera by tapping on the camera after making the settings.

Using the LED illuminator as an auxiliary light [LED Illuminator]

f (Settings Menu 3) ▶ LED Illuminator

Submenu 2	Application
Off	Disables the LED illuminator.
On	Enables the LED illuminator.

- ❗ "Using the LED illuminator" (p. 34)

Printing

Direct printing (PictBridge¹)

By connecting the camera to a PictBridge-compatible printer, you can print images directly without using a computer.

To find out if your printer supports PictBridge, refer to the printer's instruction manual.

¹ PictBridge is a standard for connecting digital cameras and printers of different makers and printing out pictures directly.

- ! The printing modes, paper sizes, and other parameters that can be set with the camera vary depending on the printer that is used. For details, refer to the printer's instruction manual.
- ! For details on the available paper types, loading paper, and installing ink cassettes, refer to the printer's instruction manual.

Printing images at the printer's standard settings [Easy Print]

- ! In the setup menu, set [USB Connection] to [Print]. [USB Connection] (p. 46)

1 Display the image to be printed on the monitor.

- ! "Viewing images" (p. 21)

2 Turn on the printer, and then connect the printer and camera.-

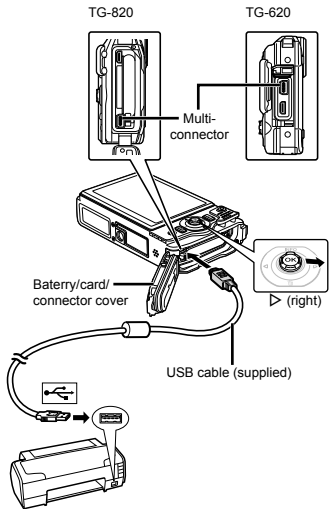

3 Press **▶** to start printing.

4 To print another image, use **◀▶** to select an image, and press the **Ⓞ** button.

To exit printing

After a selected image is displayed on the screen, disconnect the USB cable from the camera and printer.

Changing the printer's settings for printing [Custom Print]

1 Follow Steps 1 and 2 for [Easy Print] (p. 54).

2 Press the **(OK)** button.

3 Use **△▽** to select the print mode, and press the **(OK)** button.

Submenu 2	Application
Print	This prints the image selected in Step 6.
All Print	This prints all images stored in the internal memory or card.
Multi Print	This prints one image in a multiple layout format.
All Index	This prints an index of all images stored in the internal memory or card.
Print Order ^{*1}	This prints images based on the print reservation data on the card.

^{*1} [Print Order] is available only when print reservations have been made. "Print Reservations (DPOF)" (p. 57)

4 Use **△▽** to select [Size] (Submenu 3), and press **▷**.

! If the [Printpaper] screen is not displayed, the [Size], [Borderless], and [Pics/Sheet] are set to the printer's standard.



5 Use **△▽** to select the [Borderless] or [Pics/Sheet] settings, and press the **(OK)** button.

Submenu 4	Application
Off/On ^{*1}	The image is printed with a border around it ([Off]). The image is printed to fill the entire paper ([On]).
(The number of images per sheet varies depending on the printer.)	The number of images per sheet ([Pics/Sheet]) is selectable only when [Multi Print] is selected in Step 3.

^{*1} The available settings for [Borderless] vary depending on the printer.

! If [Standard] is selected in Steps 4 and 5, the image is printed at the printer's standard settings.

6 Use **<▷** to select an image.

7 Press **△** to make a print reservation for the current image.
Press **▽** to make the detailed printer settings for the current image.

To make the detailed printer settings

- 1 Use $\Delta \nabla \triangleleft \triangleright$ to select the setting, and press the \odot button.

Submenu 5	Submenu 6	Application
	0 to 10	This selects the number of prints.
Date	With/Without	Selecting [With] prints the images with the date. Selecting [Without] prints the images without the date.
File Name	With/Without	Selecting [With] prints the file name on the image. Selecting [Without] does not print any file name on the image.
	(Proceeds to the setting screen.)	This selects a portion of the image for printing.

To crop an image []

- 1 Use the zoom lever to select the size of the cropping frame, use $\Delta \nabla \triangleleft \triangleright$ to move the frame, and then press the \odot button.

Cropping frame



- 2 Use $\Delta \nabla$ to select [OK], and press the \odot button.

- 8 If necessary, repeat Steps 6 and 7 to select the image to be printed, make the detailed settings, and set [Single Print].

- 9 Press the \odot button.

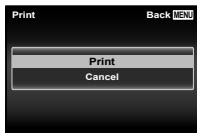

- 10 Use $\Delta \nabla$ to select [Print], and press the \odot button.

- Printing starts.
- When [Option Set] is selected in [All Print] mode, [Print Info] screen is displayed.
- When printing is finished, the [Print Mode Select] screen is displayed.

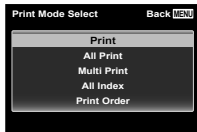

To cancel printing

- 1 Press the **MENU** button while [Do Not Remove USB Cable] is displayed.
- 2 Select [Cancel] using $\Delta \nabla$ and then press the \odot button.

- 11 Press the **MENU** button.

- 12 When the message [Remove USB Cable] is displayed, disconnect the USB cable from the camera and printer.

Print Reservations (DPOF¹)

In print reservations, the number of prints and date imprint option are saved in the image on the card. This enables easy printing at a printer or print shop supporting DPOF by using only the print reservations on the card without a computer or a camera.

¹ DPOF is a standard for storing automatic printout information from digital cameras.

- ! Print reservations can be set only for the images stored on the card.
- ! DPOF reservations set by another DPOF device cannot be changed by this camera. Make changes using the original device. Making new DPOF reservations with this camera will erase the reservations made by the other device.
- ! DPOF print reservations can be made for up to 999 images per card.

Single-frame print reservations [L]

1 Display the setup menu.

- ! "Setup menu" (p. 9)

2 From the playback menu [P], select [Print Order] and then press the [OK] button.

3 Use $\Delta \nabla$ to select [L], and press the [OK] button.

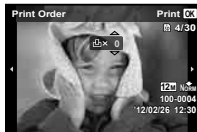

4 Use $\triangleleft \triangleright$ to select the image for print reservation. Use $\Delta \nabla$ to select the quantity. Press the [OK] button.

5 Use $\Delta \nabla$ to select the [D] (date print) screen option, and press the [OK] button.

Submenu 2	Application
No	This prints the image only.
Date	This prints the image with the shooting date.
Time	This prints the image with the shooting time.

6 Use $\Delta \nabla$ to select [Set], and press the [OK] button.

Reserving one print each of all images on the card [ALL]

1 Follow Steps 1 and 2 in [L] (p. 57).

2 Use $\Delta \nabla$ to select [ALL], and press the [OK] button.

3 Follow Steps 5 and 6 in [L].





Resetting all print reservation data

1 Follow Steps 1 and 2 in [L] (p. 57).

2 Select either [L] or [ALL], and press the [OK] button.

3 Use $\Delta \nabla$ to select [Reset], and press the [OK] button.

Resetting the print reservation data for selected images

- 1** Follow Steps 1 and 2 in [📄] (p. 57).
- 2** Use $\Delta \nabla$ to select [📄], and press the  button.
- 3** Use $\Delta \nabla$ to select [Keep] and press the  button.
- 4** Use $\triangleleft \triangleright$ to select the image with the print reservation you want to cancel. Use $\Delta \nabla$ to set the print quantity to "0".
- 5** If necessary, repeat Step 4, and then press the  button when finished.
- 6** Use $\Delta \nabla$ to select the [🕒] (date print) screen option, and press the  button.
 - The settings are applied to the remaining images with the print reservation data.
- 7** Use $\Delta \nabla$ to select [Set], and press the  button.

Usage Tips

If the camera does not work as intended, or if an error message is displayed on the screen, and you are unsure of what to do, refer to the information below to fix the problem(s).

Troubleshooting

Battery

“The camera does not work even when batteries are installed”.

- Insert recharged batteries in the correct direction. “Inserting the battery and card” (p. 11), “Charging the battery with the included USB-AC adapter” (p. 12)
- Battery performance may have been reduced temporarily due to low temperature. Take the batteries out of the camera, and warm them by putting them in your pocket for a while.



Card/Internal memory

“An error message is displayed”.

“Error message” (p. 60)

Shutter button

“No picture is taken when the shutter button is pressed”.

- Cancel sleep mode.
To save battery power, the camera automatically goes into sleep mode and the monitor turns off if there is no operation for 3 minutes when the camera is turned on. No picture is taken even if the shutter button is fully pressed in this mode. Operate the zoom lever or other buttons to restore the camera from sleep mode before taking a picture. If the camera is left for another 12 minutes, it automatically turns off. Press the **ON/OFF** button to turn the camera on.
- Press the  button to switch to the shooting mode.
- Wait until  (flash charge) stops blinking before taking pictures.

- With prolonged camera use, the internal temperature may increase, resulting in automatic shutdown. If this occurs, remove the battery from the camera and wait until the camera has sufficiently cooled. The camera’s external temperature may also increase during use, however this is normal and does not indicate malfunction.

Monitor

“Difficult to see”.

- Condensation may have occurred. Turn off the power, and wait for the camera body to become acclimated to the surrounding temperature and dry out before taking pictures.

“The light is caught in the picture”.

- Shooting with flash in dark situations results in an image with many flash reflections on dust in the air.

Date and time function

“Date and time settings return to the default setting”.

- If the batteries are removed and left out of the camera for about 3 days¹, the date and time settings return to the default setting, and must be reset.
¹ The time until the date and time settings return to the default setting varies depending on how long the batteries have been loaded.
“Language, date, time, and time zone” (p. 16)









Miscellaneous









“The camera makes a noise when taking pictures”.

- The camera may activate the lens and make a noise even if no operation is performed. This is because the camera automatically performs actions of auto focus as far as it is ready to shoot.

Error message

When one of the messages below is displayed on the monitor, check the corrective action.

Error message	Corrective action
 Card Error	Card problem Insert a new card.
 Write Protect	Card problem The card write-protect switch is set to the "LOCK" side. Release the switch.
 Memory Full	Internal memory problem • Insert a card. • Erase unwanted images. ¹
 Card Full	Card problem • Replace the card. • Erase unwanted images. ¹
	Card problem Use Δ ∇ to select [Format], and press the \odot button. Next, use Δ ∇ to select [Yes], and press the \odot button. ²
	Internal memory problem Use Δ ∇ to select [Memory Format], and press the \odot button. Next, use Δ ∇ to select [Yes], and press the \odot button. ²
 No Picture	Internal memory/Card problem Take pictures before viewing them.
 Picture Error	Problem with selected image Use photo retouch software, etc. to view the image on a computer. If the image still cannot be viewed, the image file is corrupted.

Error message	Corrective action
 The Image Cannot Be Edited	Problem with selected image Use photo retouch software, etc. to edit the image on a computer.
 Battery Empty	Battery problem Charge the battery.
 No Connection	Connection problem Connect the camera and computer or printer correctly.
 No Paper	Printer problem Load paper into the printer.
 No Ink	Printer problem Refill the ink in the printer.
 Jammed	Printer problem Remove the jammed paper.
 Settings Changed³	Printer problem Return to the status where the printer can be used.
 Print Error	Printer problem Turn off the camera and printer, check the printer for any problems, and then turn the power on again.
 Cannot Print⁴	Problem with selected image Use a computer to print.

¹ Before erasing important images, download them to a computer.

² All data will be erased.

³ This is displayed, for instance, when the printer's paper tray has been removed. Do not operate the printer while making the print settings on the camera.

⁴ This camera may be unable to print images taken by other cameras.

Shooting tips

When you are unsure of how to take a picture that you envision, refer to the information below.

Focusing



“Focusing on the subject”

- **Taking a picture of a subject not in the center of the screen**

After focusing on an object at the same distance as the subject, compose the shot, and take the picture.

Pressing the shutter button halfway (p. 17)

- **Set [AF Mode] (p. 37) to [Face/ESP]**
- **Taking a picture in [AF Tracking] mode (p. 37)**
The camera tracks the subject movement automatically to focus on it continuously.
- **Taking a picture of subjects where autofocus is difficult**

In the following cases, after focusing on an object (by pressing the shutter button halfway down) with high contrast at the same distance as the subject, compose the shot, and take the picture.

Subjects with low contrast



When extremely bright objects appear in the center of the screen



Object with no vertical lines*

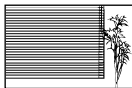

- * It is also effective to compose the shot by holding the camera vertically to focus, and then returning to the horizontal position to take the picture.

When objects are at different distances



Fast-moving object

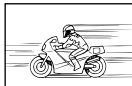

The subject is not in the center of the frame



Camera shake



“Taking pictures without camera shake”

- **Taking pictures using [Image Stabilizer] (p. 38)**

The image pickup device shifts to correct for camera shake even if the ISO sensitivity is not increased. This function is also effective when taking pictures at a high zoom magnification.

- **Shooting movies using [IS Movie Mode] (p. 38)**

- **Select [Sport] in the scene mode (p. 25)**

The [Sport] mode uses a fast shutter speed and can reduce the blur incurred by a moving subject.

- **Taking pictures at a high ISO sensitivity**

If a high ISO sensitivity is selected, pictures can be taken at a high shutter speed even at locations where a flash cannot be used.

“Selecting the ISO sensitivity” (p. 32)

Exposure (brightness)



“Taking pictures with the right brightness”

- **Taking pictures of a subject against a backlight**

Faces or backgrounds are bright even when shot against backlight.

[Shadow Adjust] (p. 36)

- **Taking pictures using [Face/iESP] (p. 37)**

Appropriate exposure is obtained for a face against backlight, and the face is brightened.

- **Taking pictures using [] for [ESP/] (p. 37)**

Brightness is matched with a subject in the center of the screen and the image is not affected by background light.

- **Taking pictures using [Fill In] (p. 20) flash**

A subject against backlight is brightened.

- **Taking pictures of a white beach or snow scene**

Set the mode to [Beach & Snow] or [Snow]* (p. 25).

* TG-820 only

- **Taking pictures using exposure compensation (p. 31)**

Adjust the brightness while viewing the screen for taking the picture. Normally, taking pictures of white subjects (such as snow) results in images that are darker than the actual subject. Use the exposure compensation to adjust in the positive (+) direction to express whites as they appear. When taking pictures of black subjects, on the other hand, it is effective to adjust in the negative (-) direction.

Color hue



“Taking pictures with colors at the same shade as they appear”

- **Taking pictures by selecting white balance (p. 31)**

Best results in most environments can normally be obtained with the [WB Auto] setting, but for some subjects, you should try experimenting with different settings. (This is especially true for sunshade under a clear sky, mixed natural and artificial light settings, and so on.)

Image quality



“Taking sharper pictures”

- **Taking pictures with the optical zoom or super-resolution zoom**

Avoid using digital zoom (p. 37) to take pictures.

- **Taking pictures at a low ISO sensitivity**

If the picture is taken with a high ISO sensitivity, noise (small colored spots and color unevenness that were not in the original image) can occur, and the image can appear grainy.

“Selecting the ISO sensitivity” (p. 32)

Panorama



“Taking pictures so that the frames are stitched smoothly”

- **A tip for panoramic shooting**

Taking pictures by pivoting with the camera at the center prevents shifting of the image. When taking pictures of close objects in particular, pivoting with the lens end at the center produces favorable results.

[Panorama] (p. 28)

Batteries



“Making batteries last longer”

- **Set [Power Save] (p. 51) to [On]**

Playback/Editing tips

Playback



“Playing images in the internal memory and card”

- **Remove the card and display the images in internal memory**
 - “Inserting the battery and card” (p. 11)

“Viewing images with high picture quality on a high-definition TV”

- **Connect the camera to the TV using an HDMI cable (sold separately)**
 - “Playing back images on a TV” (p. 48)

Editing



“Erasing the sound recorded to a still image”

- **Record over the sound with silence when playing back the image**
 - “Adding sound to still images [🔊]” (p. 42)

Appendix

Camera care

Exterior

- Wipe gently with a soft cloth. If the camera is very dirty, soak the cloth in mild soapy water and wring well. Wipe the camera with the damp cloth and then dry it with a dry cloth. If you have used the camera at the beach, use a cloth soaked in clean water and wrung well.
- If any dirt, dust, sand, or other foreign materials adhere to the camera after use, wash the camera using the method described on p. 69.

Monitor

- Wipe gently with a soft cloth.

Lens

- Blow dust off the lens with a commercial blower, then wipe gently with a lens cleaner.

⚠ Do not use strong solvents such as benzene or alcohol, or chemically treated cloth.

⚠ Mold may form on the lens surface if the lens is left dirty.

Battery/USB-AC adapter

- Wipe gently with a soft, dry cloth.

Storage

- When storing the camera for extended periods, remove the battery, USB-AC adapter and card, and keep in a cool, dry place that is well ventilated.
- Periodically insert the battery and test the camera functions.

⚠ Avoid leaving the camera in places where chemical products are handled since this may result in corrosion.

Battery and USB-AC adapter

- This camera uses one Olympus lithium ion battery (LI-50B). No other type of batteries can be used.
- ⚠ **Caution:**
There is a risk of explosion if the battery is replaced with the incorrect battery type.
Dispose of the used battery following the instructions. (p. 72)
- Power consumption by the camera varies depending on which functions are used.
- During the conditions described below, power is consumed continuously and the battery becomes exhausted quickly.
 - The zoom is used repeatedly.
 - The shutter button is pressed halfway repeatedly in shooting mode, activating the auto focus.
 - A picture is displayed on the monitor for an extended period of time.
 - The camera is connected to a printer.
- Using an exhausted battery may cause the camera to turn off without displaying the battery level warning.
- The included USB-AC adapter F-2AC is designed to be used only with this camera. Other cameras cannot be charged with this USB-AC adapter.
- Do not connect the included USB-AC adapter F-2AC to equipment other than this camera.
- For plug-in type USB-AC adapter:
The included USB-AC adapter F-2AC is intended to be correctly orientated in a vertical or floor mount position.

Using a separately sold USB-AC adapter

The USB-AC adapter F-3AC (sold separately) can be used with this camera. Do not use any USB-AC adapter other than the dedicated one. When using F-3AC, be sure to use the USB cable included with this camera. Do not use any other USB-AC adapter with this camera.

Using a separately sold charger

A charger (UC-50: sold separately) can be used to charge the battery.

Using your charger and USB-AC adapter abroad

- The charger and USB-AC adapter can be used in most home electrical sources within the range of 100 V to 240 V AC (50/60Hz) around the world. However, depending on the country or area you are in, the AC wall outlet may be shaped differently and the charger and USB-AC adapter may require a plug adapter to match the wall outlet. For details, ask at your local electrical shop or travel agent.
- Do not use travel voltage converters as they could damage your charger and USB-AC adapter.

Eye-Fi card

- Use commercially available Eye-Fi cards.
- The Eye-Fi card may become hot during use.
- When using an Eye-Fi card, the battery may run out faster.
- When using an Eye-Fi card, the camera may function more slowly.

Using the card

A card (and internal memory) also corresponds to the film that records images in a film camera. Otherwise, the recorded images (data) can be erased, and retouching is also available with the use of a computer. Cards can be removed from the camera and exchanged, but this is not possible with the internal memory. Use of larger capacity cards enables you to take more pictures.

Cards compatible with this camera

SD/SDHC/SDXC/Eye-Fi card (for compatibility card details, visit the Olympus website.)



SD/SDHC/SDXC card write-protect switch

The SD/SDHC/SDXC card body has a write-protect switch.

If you set the switch to the "LOCK" side, you will not be able to write to the card, delete data or format. Return the switch to enable writing.



Checking the image saving location

The memory indicator shows whether the internal memory or card is being used during shooting and playback.

Current memory indicator

: Internal memory is being used

: Card is being used

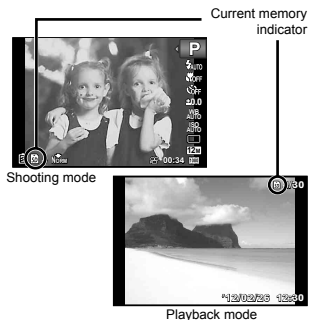

Readout/recording process of the card

During shooting, the current memory indicator lights up in red while the camera is writing data. Never open the battery/card/connector cover or unplug the USB cable. This can not only damage the image data but also render the internal memory or card unusable.



-  Even if [Memory Format]/[Format], [Erase], [Sel. Image], or [All Erase] is performed, the data in the card is not completely erased. When disposing of the card, damage the card to prevent the disclosure of personal data.



Number of storable pictures (still images)/Continuous recording length (movies) in the internal memory and cards

- ! The figures in the following tables are quoted only as a rough guideline. The actual number of storable pictures or continuous recording lengths will differ according to the shooting conditions and memory cards used.
- ! The figures in the table below are the number of the storable pictures when using the internal memory formatted. [Memory Format]/[Format] (p. 45)

Still pictures

Image Size	Compression	Number of storable still pictures	
		Internal memory	SD/SDHC/SDXC card (4GB)
12M 3968×2976	FINE	8	663
	NORM	15	1,298
8M 3264×2448	FINE	11	968
	NORM	23	1,877
5M 2560×1920	FINE	19	1,544
	NORM	38	3,128
3M 2048×1536	FINE	29	2,346
	NORM	59	4,692
2M 1600×1200	FINE	48	3,935
	NORM	93	7,624
1M 1280×960	FINE	74	5,809
	NORM	139	11,087
VGA 640×480	FINE	249	20,314
	NORM	412	30,452
16:9L 3968×2232	FINE	10	877
	NORM	21	1,718
16:9S 1920×1080	FINE	45	3,697
	NORM	87	6,777

Movies

Image Size	Continuous recording length	
	Internal memory	SD/SDHC/SDXC card (4GB)
 1920×1080 ¹	18 sec.	24 min. 45 sec.
 1280×720 ¹	26 sec.	29 min.
 640×480	1 min. 9 sec.	96 min. 15 sec.

¹ The continuous recording length is up to 29 minutes in the HD quality specified.

 The maximum file size of a single movie is 4 GB, regardless of the capacity of the card.

Increasing the number of pictures that can be taken

Either erase unwanted images, or connect the camera to a computer or other device to save the images, and then erase the images in the internal memory or card. [Erase] (p. 22, 43), [Sel. Image] (p. 44), [All Erase] (p. 44), [Memory Format]/[Format] (p. 45)

Important information about water and shock resistant features

Water resistance: The waterproof feature is warranted¹ to operate at the following depths for up to one hour.

TG-820: 10 m (33 ft.)

TG-620: 5 m (16 ft.)

The waterproof feature may be compromised if the camera is subject to substantial or excessive impact.

Shock resistance: The anti-shock feature warrants² the operation of the camera against accidental impact incurred from everyday use of your digital compact camera. The anti-shock feature does not unconditionally warrant all defective operation or cosmetic damage. Cosmetic damage, such as scratches and dents, are not covered under the warranty.

As with any electronic device, proper care and maintenance are required to preserve the integrity and operation of your camera. To maintain camera performance, please take your camera to the nearest Olympus Authorized Service Center to have it inspected after any major impact. In the event the camera is damaged as a result of negligence or misuse, the warranty will not cover costs associated with the service or repair of your camera. For additional information on our warranty, please visit to the Olympus website for your local area.

Please observe the following care instructions for your camera.

- *1 As determined by Olympus pressure testing equipment in accordance with IEC Standard Publication 529 IPX8 - This means that the camera can be used normally under water at a specified water pressure.
- *2 This anti-shock performance is confirmed by Olympus' testing conditions in accordance with MIL-STD-810F, Method 516.5, Procedure IV (Transit Drop Test). For more details of Olympus' testing conditions, please refer to the Olympus website for your local area.

Before Use:

- Check the camera for foreign material including dirt, dust or sand.
- Be sure to close and lock the battery/card/connector cover so that the lock makes a clicking sound. (p. 12)
- Do not open the battery/card/connector cover with wet hands, while under water, or in a damp or dusty environment (e.g. beach).

After Use:

- Be sure to wipe off any excess water or debris after using the camera under water.
- **After the camera is used under seawater, immerse the camera in a bucket containing fresh water for about 10 minutes (with the battery/card/connector cover firmly closed). After that, dry the camera in the shade with good ventilation.**
- **Water drops may be observed on the inner surface of the battery/card/connector cover after you open the cover. If any water drops are found, be sure to wipe them off before using the camera.**

Notes after use

- Foreign materials may be attached to the camera when using the camera in conditions with foreign materials such as dirt, dust or sand. If you continue to use the camera in such conditions, it could cause damage to the camera. To avoid such damage, wash the camera using the following method.

- ① Insert the battery then close and lock the battery/card/connector cover firmly so that the lock makes a clicking sound. (p. 12)
- ② Fill a bucket or other container with fresh water, immerse the camera facing downward in the bucket and shake the camera thoroughly. Or rinse the camera by placing it directly under a strong stream of tap water.
- ③ Press the **ON/OFF** button several times in the water and close/open the lens cover repeatedly. (TG-820 only)
- ④ Furthermore, shake the camera further with the cover opened. (TG-820 only)

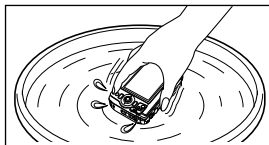



Follow the Steps ① to ④, then check if the lens cover moves smoothly.

If the lens cover does not move smoothly, rinse the lens face by placing it directly under a strong stream of tap water and pressing the **ON/OFF** button repeatedly.

Storage and Maintenance

- Do not leave the camera in an environment at high temperature (40°C (104°F) or more) or at low temperature (-10°C (14°F) or less). Failure to do so may break down water resistance.
 - Do not use chemicals for cleaning, rust prevention, anti-fogging, repairing, etc. Failure to do so may break down water resistance.
 - **Do not leave the camera in water for a long time. Prolonged exposure to water will cause damage to the camera's appearance and/or deteriorate water resistance.**
 - **In order to preserve the water resistant feature, as with any underwater housing, it is recommended that the waterproof packing (and seals) are replaced annually. For the Olympus distributors or service stations where the waterproof packing can be replaced, visit Olympus website for your local area.**
-  The included accessories (e.g. USB-AC adapter) do not offer shock or water resistance.

SAFETY PRECAUTIONS

	CAUTION RISK OF ELECTRIC SHOCK DO NOT OPEN	
CAUTION: TO REDUCE THE RISK OF ELECTRICAL SHOCK, DO NOT REMOVE COVER (OR BACK). NO USER-SERVICEABLE PARTS INSIDE. REFER SERVICING TO QUALIFIED OLYMPUS SERVICE PERSONNEL.		



An exclamation mark enclosed in a triangle alerts you to important operating and maintenance instructions in the documentation provided with the product.



DANGER If the product is used without observing the information given under this symbol, serious injury or death may result.



WARNING If the product is used without observing the information given under this symbol, injury or death may result.



CAUTION If the product is used without observing the information given under this symbol, minor personal injury, damage to the equipment, or loss of valuable data may result.

WARNING!

TO AVOID THE RISK OF FIRE OR ELECTRICAL SHOCK, NEVER DISASSEMBLE, EXPOSE THIS PRODUCT TO WATER OR OPERATE IN A HIGH HUMIDITY ENVIRONMENT.

General Precautions

Read All Instructions — Before you use the product, read all operating instructions. Save all manuals and documentation for future reference.

Cleaning — Always unplug this product from the wall outlet before cleaning. Use only a damp cloth for cleaning. Never use any type of liquid or aerosol cleaner, or any type of organic solvent to clean this product.

Attachments — For your safety, and to avoid damaging the product, use only accessories recommended by Olympus.

Water and Moisture — For precautions on products with weatherproof designs, read the weatherproofing sections.

Location — To avoid damage to the product, mount the product securely on a stable tripod, stand, or bracket.

Power Source — Connect this product only to the power source described on the product label.

Lightning — If a lightning storm occurs while using a USB-AC adapter, remove it from the wall outlet immediately.

Foreign Objects — To avoid personal injury, never insert a metal object into the product.

Heat — Never use or store this product near any heat source such as a radiator, heat register, stove, or any type of equipment or appliance that generates heat, including stereo amplifiers.

Handling the Camera

WARNING

- **Do not use the camera near flammable or explosive gases.**
- **Do not use the flash and LED (including AF illuminator) on people (infants, small children, etc.) at close range.**
 - You must be at least 1 m (3 ft.) away from the faces of your subjects. Firing the flash too close to the subject's eyes could cause a momentary loss of vision.
- **Keep young children and infants away from the camera.**
 - Always use and store the camera out of the reach of young children and infants to prevent the following dangerous situations which could cause serious injury:
 - Becoming entangled in the camera strap, causing strangulation.
 - Accidentally swallowing the battery, cards or other small parts.
 - Accidentally firing the flash into their own eyes or those of another child.
 - Accidentally being injured by the moving parts of the camera.
- **Do not look at the sun or strong lights with the camera.**
- **Do not use or store the camera in dusty or humid places.**
- **Do not cover the flash with a hand while firing.**
- **Use SD/SDHC/SDXC memory cards or Eye-Fi cards only. Never use other types of cards.**
 - If you accidentally insert another type of card into the camera, contact an authorized distributor or service center. Do not try to remove the card by force.
- **If you find that the USB-AC adapter is extremely hot or notice any unusual odors, noise, or smoke around it, unplug the power plug from wall outlet immediately and stop using it. Then, contact an authorized distributor or service center.**

CAUTION

- **Stop using the camera immediately if you notice any unusual odors, noise, or smoke around it.**
 - Never remove the batteries with bare hands, which may cause a fire or burn your hands.
- **Do not leave the camera in places where it may be subject to extremely high temperatures.**
 - Doing so may cause parts to deteriorate and, in some circumstances, cause the camera to catch fire. Do not use the charger or USB-AC adapter if it is covered (such as a blanket). This could cause overheating, resulting in fire.
- **Handle the camera with care to avoid getting a low-temperature burn.**
 - When the camera contains metal parts, overheating can result in a low-temperature burn. Pay attention to the following:
 - When used for a long period, the camera will get hot. If you hold on to the camera in this state, a low-temperature burn may be caused.
 - In places subject to extremely cold temperatures, the temperature of the camera's body may be lower than the environmental temperature. If possible, wear gloves when handling the camera in cold temperatures.
- **Be careful with the strap.**
 - Be careful with the strap when you carry the camera. It could easily catch on stray objects and cause serious damage.
- **Do not touch the metallic parts of the camera for a long period of time at low temperatures.**
 - This may damage your skin. At low temperatures, handle the camera while wearing gloves.

Battery Handling Precautions

Follow these important guidelines to prevent batteries from leaking, overheating, burning, exploding, or causing electrical shocks or burns.

DANGER

- The camera uses a lithium ion battery specified by Olympus. Charge the battery with the specified USB-AC adapter or charger. Do not use any other USB-AC adapters or chargers.
- Never heat or incinerate batteries.
- Take precautions when carrying or storing batteries to prevent them from coming into contact with any metal objects such as jewelry, pins, fasteners, etc.

- Never store batteries where they will be exposed to direct sunlight, or subjected to high temperatures in a hot vehicle, near a heat source, etc.
- To prevent causing battery leaks or damaging their terminals, carefully follow all instructions regarding the use of batteries. Never attempt to disassemble a battery or modify it in any way, solder, etc.
- If battery fluid gets into your eyes, flush your eyes immediately with clear, cold running water and seek medical attention immediately.
- Always store batteries out of the reach of small children. If a child accidentally swallows a battery, seek medical attention immediately.
- If you cannot remove the battery from the camera, contact an authorized distributor or service center. Do not try to remove the battery by force.
Damage to the battery exterior (scratches, etc.) may produce heat or an explosion.

WARNING

- Keep batteries dry at all times.
- To prevent batteries from leaking, overheating, or causing a fire or explosion, use only batteries recommended for use with this product.
- Insert the battery carefully as described in the operating instructions.
- If rechargeable batteries have not been recharged within the specified time, stop charging them and do not use them.
- Do not use a battery if it is cracked or broken.
- If a battery leaks, becomes discolored or deformed, or becomes abnormal in any other way during operation, stop using the camera.
- If a battery leaks fluid onto your clothing or skin, remove the clothing and flush the affected area with clean, running cold water immediately. If the fluid burns your skin, seek medical attention immediately.
- Never subject batteries to strong shocks or continuous vibration.

CAUTION

- Before loading, always inspect the battery carefully for leaks, discoloration, warping, or any other abnormality.
- The battery may become hot during prolonged use. To avoid minor burns, do not remove it immediately after using the camera.
- Always unload the battery from the camera before storing the camera for a long period.

Caution for Usage Environment

- To protect the high-precision technology contained in this product, never leave the camera in the places listed below, no matter if in use or storage:
 - Places where temperatures and/or humidity are high or go through extreme changes. Direct sunlight, beaches, locked cars, or near other heat sources (stove, radiator, etc.) or humidifiers.
 - In sandy or dusty environments.
 - Near flammable items or explosives.
 - In wet places, such as bathrooms or in the rain. When using products with weatherproof designs, read their manuals as well.
 - In places prone to strong vibrations.
- Never drop the camera or subject it to severe shocks or vibrations.
- When attaching the camera to or removing it from a tripod, rotate the tripod screw, not the camera.
- Before transporting the camera, remove a tripod and all other non-OLYMPUS accessories.
- Do not touch electric contacts on cameras.
- Do not leave the camera pointed directly at the sun. This may cause lens or shutter curtain damage, color failure, ghosting on the image pickup device, or may possibly cause fires.
- Do not push or pull severely on the lens.
- Before storing the camera for a long period, remove the batteries. Select a cool, dry location for storage to prevent condensation or mold from forming inside the camera. After storage, test the camera by turning it on and pressing the shutter button to make sure that it is operating normally.
- The camera may malfunction if it is used in a location where it is subject to a magnetic/electromagnetic field, radio waves, or high voltage, such as near a TV set, microwave, video game, loud speakers, large monitor unit, TV/radio tower, or transmission towers. In such cases, turn the camera off and on again before further operation.
- Always observe the operating environment restrictions described in the camera's manual.

Battery

- This camera uses a lithium ion battery specified by Olympus. Do not use any other type of battery.
- If the battery's terminals get wet or greasy, camera contact failure may result. Wipe the battery well with a dry cloth before use.
- Always charge a battery when using it for the first time, or if it has not been used for a long period.
- When operating the camera with battery power at low temperatures, try to keep the camera and spare battery as warm as possible. A battery that has run down at low temperatures may be restored after it is warmed at room temperature.
- The number of pictures you can take may vary depending on the shooting conditions or battery.
- Before going on a long trip, and especially before traveling abroad, purchase extra batteries. A recommended battery may be difficult to obtain while traveling.
- When storing the battery for a long period, select a cool location for storage.
- Please recycle batteries to help save our planet's resources. When you throw away dead batteries, be sure to cover their terminals and always observe local laws and regulations.

Monitor

- Do not push the monitor forcibly; otherwise the image may become vague, resulting in a playback mode failure or damage to the monitor.
- A strip of light may appear on the top/bottom of the monitor, but this is not a malfunction.
- When a subject is viewed diagonally in the camera, the edges may appear zigzagged on the monitor. This is not a malfunction; it will be less noticeable in playback mode.
- In places subject to low temperatures, the monitor may take a long time to turn on or its color may change temporarily. When using the camera in extremely cold places, it is a good idea to occasionally place it in a warm place. The monitor exhibiting poor performance due to low temperatures will recover in normal temperatures.
- The monitor of this product is manufactured with high-quality accuracy, however, there may be a stuck or dead pixel on the monitor. These pixels do not have any influence on the image to be saved. Because of the characteristics, the unevenness of the color or brightness may also be found depending on the angle, but this is due to the structure of the monitor. This is not a malfunction.

Legal and Other Notices

- Olympus makes no representations or warranties regarding any damages, or benefit expected by using this unit lawfully, or any request from a third person, which are caused by the inappropriate use of this product.
- Olympus makes no representations or warranties regarding any damages or any benefit expected by using this unit lawfully which are caused by erasing picture data.

Disclaimer of Warranty

- Olympus makes no representations or warranties, either expressed or implied, by or concerning any content of these written materials or software, and in no event shall be liable for any implied warranty of merchantability or fitness for any particular purpose or for any consequential, incidental or indirect damages (including but not limited to damages for loss of business profits, business interruption and loss of business information) arising from the use or inability to use these written materials or software or equipment. Some countries do not allow the exclusion or limitation of liability for consequential or incidental damages or of the implied warranty, so the above limitations may not apply to you.
- Olympus reserves all rights to this manual.

Warning

Unauthorized photographing or use of copyrighted material may violate applicable copyright laws. Olympus assumes no responsibility for unauthorized photographing, use or other acts that infringe upon the rights of copyright owners.

Copyright Notice

All rights reserved. No part of these written materials or this software may be reproduced or used in any form or by any means, electronic or mechanical, including photocopying and recording or the use of any type of information storage and retrieval system, without the prior written permission of Olympus. No liability is assumed with respect to the use of the information contained in these written materials or software, or for damages resulting from the use of the information contained therein. Olympus reserves the right to alter the features and contents of this publication or software without obligation or advance notice.

FCC Notice

- Radio and Television Interference
- Changes or modifications not expressly approved by the manufacturer may void the user's authority to operate this equipment. This equipment has been tested and found to comply with the limits for a Class B digital device, pursuant to Part 15 of the FCC Rules. These limits are designed to provide reasonable protection against harmful interference in a residential installation.
- This equipment generates, uses, and can radiate radio frequency energy and, if not installed and used in accordance with the instructions, may cause harmful interference to radio communications.
- However, there is no guarantee that interference will not occur in a particular installation. If this equipment does cause harmful interference to radio or television reception, which can be determined by turning the equipment off and on, the user is encouraged to try to correct the interference by one or more of the following measures:
 - Adjust or relocate the receiving antenna.
 - Increase the distance between the camera and receiver.
 - Connect the equipment to an outlet on a circuit different from that to which the receiver is connected.
 - Consult your dealer or an experienced radio/TV technician for help. Only the OLYMPUS-supplied USB cable should be used to connect the camera to USB enabled personal computers (PC).

Any unauthorized changes or modifications to this equipment would void the user's authority to operate it.

Use Only Dedicated Rechargeable Battery, Battery Charger and USB-AC adapter

We strongly recommend that you use only the genuine Olympus dedicated rechargeable battery, battery charger and USB-AC adapter with this camera. Using a non-genuine rechargeable battery, battery charger and/or USB-AC adapter may result in fire or personal injury due to leakage, heating, ignition or damage to the battery. Olympus does not assume any liability for accidents or damage that may result from the use of a battery, battery charger and/or USB-AC adapter that are not genuine Olympus accessories.

For customers in North and South America

For customers in USA

Declaration of Conformity

Model Number: TG-820, TG-620

Trade Name: OLYMPUS

Responsible Party:

OLYMPUS IMAGING AMERICA INC.

Address: 3500 Corporate Parkway, P.O. Box 610,
Center Valley, PA 18034-0610, U.S.A.

Telephone Number: 484-896-5000

Tested To Comply With FCC Standards
FOR HOME OR OFFICE USE

This device complies with Part 15 of the FCC rules. Operation is subject to the following two conditions:

- (1) This device may not cause harmful interference.
- (2) This device must accept any interference received, including interference that may cause undesired operation.

For customers in CANADA

This Class B digital apparatus complies with Canadian ICES-003.

OLYMPUS WORLDWIDE LIMITED WARRANTY - IMAGING PRODUCTS

Olympus warrants that the enclosed Olympus® imaging product(s) and related Olympus® accessories (individually a "Product" and collectively the "Products") will be free from defects in materials and workmanship under normal use and service for a period of one (1) year from the date of purchase. If any Product proves to be defective within the one-year warranty period, the customer must return the defective Product to any of Olympus Service Centers, following the procedure set forth below (See "WHAT TO DO WHEN SERVICE IS NEEDED").

Olympus, at its sole discretion, will repair, replace, or adjust the defective Product, provided that Olympus investigation and factory inspection disclose that (a) such defect developed under normal and proper use and (b) the Product is covered under this limited warranty.

Repair, replacement, or adjustment of defective Products shall be Olympus's sole obligation and the customer's sole remedy hereunder.

The customer is liable and shall pay for shipment of the Products to the Olympus Service Center.

Olympus shall not be obligated to perform preventive maintenance, installation, deinstallation, or maintenance. Olympus reserves the right to (i) use reconditioned, refurbished, and/or serviceable used parts (that meet Olympus's quality assurance standards) for warranty or any other repairs and (ii) make any internal or external design and/or feature changes on or to its products without any liability to incorporate such changes on or to the Products.

WHAT IS NOT COVERED BY THIS LIMITED WARRANTY

Excluded from this limited warranty and not warranted by Olympus in any fashion, either express, implied, or by statute, are:

- (a) products and accessories not manufactured by Olympus and/or not bearing the "OLYMPUS" brand label (the warranty coverage for products and accessories of other manufacturers, which may be distributed by Olympus, is the responsibility of the manufacturers of such products and accessories in accordance with the terms and duration of such manufacturers' warranties);
- (b) any Product which has been disassembled, repaired, tampered with, altered, changed, or modified by persons other than Olympus's own authorized service personnel unless repair by others is made with the written consent of Olympus;
- (c) defects or damage to the Products resulting from wear, tear, misuse, abuse, negligence, sand, liquids, impact, improper storage, nonperformance of scheduled operator and maintenance items, battery leakage, use of non-"OLYMPUS" brand accessories, consumables, or supplies, or use of the Products in combination with non-compatible devices;
- (d) software programs;
- (e) supplies and consumables (including but not limited to lamps, ink, paper, film, prints, negatives, cables and batteries); and/or
- (f) Products which do not contain a validly placed and recorded Olympus serial number, unless they are a model on which Olympus does not place and record serial numbers.

EXCEPT FOR THE LIMITED WARRANTY SET FORTH ABOVE, OLYMPUS MAKES NO AND DISCLAIMS ALL OTHER REPRESENTATIONS, GUARANTIES, CONDITIONS, AND WARRANTIES CONCERNING THE PRODUCTS, WHETHER DIRECT OR INDIRECT, EXPRESS OR IMPLIED, OR ARISING UNDER ANY STATUTE, ORDINANCE, COMMERCIAL USAGE OR OTHERWISE, INCLUDING BUT NOT LIMITED TO ANY WARRANTY OR REPRESENTATION AS TO THE SUITABILITY, DURABILITY, DESIGN, OPERATION, OR CONDITION OF THE PRODUCTS (OR ANY PART THEREOF) OR THE MERCHANTABILITY OF THE PRODUCTS OR THEIR FITNESS FOR A PARTICULAR PURPOSE, OR RELATING TO THE INFRINGEMENT OF ANY PATENT, COPYRIGHT, OR OTHER PROPRIETARY RIGHT USED OR INCLUDED THEREIN.

IF ANY IMPLIED WARRANTIES APPLY AS A MATTER OF LAW, THEY ARE LIMITED IN DURATION TO THE LENGTH OF THIS LIMITED WARRANTY.

SOME STATES MAY NOT RECOGNIZE A DISCLAIMER OR LIMITATION OF WARRANTIES AND/OR LIMITATION OF LIABILITY SO THE ABOVE DISCLAIMERS AND EXCLUSIONS MAY NOT APPLY.

THE CUSTOMER MAY ALSO HAVE DIFFERENT AND/OR ADDITIONAL RIGHTS AND REMEDIES THAT VARY FROM STATE TO STATE.

THE CUSTOMER ACKNOWLEDGES AND AGREES THAT OLYMPUS SHALL NOT BE RESPONSIBLE FOR ANY DAMAGES THAT THE CUSTOMER MAY INCUR FROM DELAYED SHIPMENT, PRODUCT FAILURE, PRODUCT DESIGN, SELECTION, OR PRODUCTION, IMAGE OR DATA LOSS OR IMPAIRMENT OR FROM ANY OTHER CAUSE, WHETHER LIABILITY IS ASSERTED IN CONTRACT, TORT (INCLUDING NEGLIGENCE AND STRICT PRODUCT LIABILITY) OR OTHERWISE. IN NO EVENT SHALL OLYMPUS BE LIABLE FOR ANY INDIRECT, INCIDENTAL, CONSEQUENTIAL OR SPECIAL DAMAGES OF ANY KIND (INCLUDING WITHOUT LIMITATION LOSS OF PROFITS OR LOSS OF USE), WHETHER OR NOT OLYMPUS SHALL BE OR SHOULD BE AWARE OF THE POSSIBILITY OF SUCH POTENTIAL LOSS OR DAMAGE.

Representations and warranties made by any person, including but not limited to dealers, representatives, salespersons, or agents of Olympus, which are inconsistent or in conflict with or in addition to the terms of this limited warranty, shall not be binding upon Olympus unless reduced to writing and approved by an expressly authorized officer of Olympus.

This limited warranty is the complete and exclusive statement of warranty which Olympus agrees to provide with respect to the Products and it shall supersede all prior and contemporaneous oral or written agreements, understandings, proposals, and communications pertaining to the subject matter hereof. This limited warranty is exclusively for the benefit of the original customer and cannot be transferred or assigned.

WHAT TO DO WHEN SERVICE IS NEEDED

The customer must transfer any image or other data saved on a Product to another image or data storage medium and/or remove any film from the Product prior to sending the Product to Olympus for service.

IN NO EVENT SHALL OLYMPUS BE RESPONSIBLE FOR SAVING, KEEPING OR MAINTAINING ANY IMAGE OR DATA SAVED ON A PRODUCT RECEIVED BY IT FOR SERVICE, OR ON ANY FILM CONTAINED WITHIN A PRODUCT RECEIVED BY IT FOR SERVICE, NOR SHALL OLYMPUS BE RESPONSIBLE FOR ANY DAMAGES IN THE EVENT ANY IMAGE OR DATA IS LOST OR IMPAIRED WHILE SERVICE IS BEING PERFORMED (INCLUDING, WITHOUT LIMITATION, DIRECT, INDIRECT, INCIDENTAL, CONSEQUENTIAL OR SPECIAL DAMAGES, LOSS OF PROFITS OR LOSS OF USE), WHETHER OR NOT OLYMPUS SHALL BE OR SHOULD BE AWARE OF THE POSSIBILITY OF SUCH POTENTIAL LOSS OR IMPAIRMENT.

Package the Product carefully using ample padding material to prevent damage in transit and either deliver it to the Authorized Olympus Dealer that sold you the Product or ship it postage prepaid and insured to any of our Olympus Service Centers. When returning Products for service, your package should include the following:

- 1 Sales receipt showing date and place of purchase.
- 2 Copy of this limited warranty **bearing the Product serial number corresponding to the serial number on the Product** (unless it is a model on which Olympus does not place and record serial numbers).
- 3 A detailed description of the problem.
- 4 Sample prints, negatives, digital prints (or files on disk) if available and related to the problem.

When service is completed, the Product will be returned to you postage prepaid.

WHERE TO SEND PRODUCT FOR SERVICE

See "WORLDWIDE WARRANTY" for the nearest service center.

INTERNATIONAL WARRANTY SERVICE

International warranty service is available under this warranty.

For customers in Europe



"CE" mark indicates that this product complies with the European requirements for safety, health, environment and customer protection. "CE" mark cameras are intended for sales in Europe.



This symbol [crossed-out wheeled bin WEEE Annex IV] indicates separate collection of waste electrical and electronic equipment in the EU countries.

Please do not throw the equipment into the domestic refuse.

Please use the return and collection systems available in your country for the disposal of this product.



This symbol [crossed-out wheeled bin Directive 2006/66/EC Annex II] indicates separate collection of waste batteries in the EU countries.

Please do not throw the batteries into the domestic refuse. Please use the return and collection systems available in your country for the disposal of the waste batteries.

Provisions of warranty

- 1 If this product proves to be defective, although it has been used properly (in accordance with the written Handling Care and Operating instructions supplied with it), during the applicable national warranty period and has been purchased from an authorized Olympus distributor within the business area of Olympus Europa Holding GmbH as stipulated on the website: <http://www.olympus.com> this product will be repaired, or at Olympus's option replaced, free of charge. To claim under this warranty the customer must take the product before the end of the applicable national warranty period to the dealer where the product was purchased or any other Olympus service station within the business area of Olympus Europa Holding GmbH as stipulated on the website: <http://www.olympus.com>. During the one year period of the World Wide Guarantee the customer may turn the product in at any Olympus service station. Please notice that not in all countries such Olympus service station exists.
- 2 The customer shall transport the product to the dealer or Olympus authorized service station at his own risk and shall be responsible for any costs incurred in transporting the product.

Provisions of Guarantee

- 1 "OLYMPUS IMAGING CORP., Shinjuku Monolith, 2-3-1 Nishi-Shinjuku, Shinjuku-ku, Tokyo 163-0914, Japan grants a one year World Wide Guarantee. This worldwide Guarantee must be presented at an Olympus authorized repair service station before any repair can be made under conditions of this Guarantee. This Guarantee is valid only if the Guarantee Certificate and proof of purchase are presented at the Olympus repair service station. Please note that this Guarantee is in addition to and does not affect the customer's legal warranty rights under the applicable national legislation governing the sale of consumer goods mentioned above.
- 2 This Guarantee does not cover the following and the customer will be required to pay repair charge, even for defects occurring within the Guarantee period referred to above.
 - a. Any defect that occurs due to mishandling (such as an operation performed that is not mentioned in the Handling Care or other sections of the instructions, etc.)
 - b. Any defect that occurs due to repair, modification, cleaning, etc. performed by anyone other than Olympus or an Olympus authorized service station.
 - c. Any defect or damage that occurs due to transport, a fall, shock, etc. after purchase of the product.
 - d. Any defect or damage that occurs due to fire, earthquake, flood damage, thunderbolt, other natural disasters, environmental pollution and irregular voltage sources.

- e. Any defect that occurs due to careless or improper storage (such as keeping the product under conditions of high temperature and humidity, near insect repellents such as naphthalene or harmful drugs, etc.), improper maintenance, etc.
 - f. Any defect that occurs due to exhausted batteries, etc.
 - g. Any defect that occurs due to sand, mud, etc. entering the inside of the product casing.
 - h. When the Guarantee Certificate is not returned with the product.
 - i. When any alterations whatsoever are made to the Guarantee Certificate regarding the year, month and date of purchase, the customer's name, the dealer's name, and the serial number.
 - j. When proof of purchase is not presented with this Guarantee Certificate.
- 3 This Guarantee applies to the product only; the Guarantee does not apply to any other accessory equipment, such as the case, strap, lens cap and batteries.
 - 4 Olympus's sole liability under this Guarantee shall be limited to repairing or replacing the product. Any liability under the Guarantee for indirect or consequential loss or damage of any kind incurred or suffered by the customer due to a defect of the product, and in particular any loss or damage caused to any lenses, films, other equipment or accessories used with the product or for any loss resulting from a delay in repair or loss of data, is excluded. Compelling regulations by law remain unaffected by this.

Notes regarding Guarantee maintenance

- 1 This Guarantee will only be valid if the Guarantee Certificate is duly completed by Olympus or an authorized dealer or other documents contain sufficient proof. Therefore, please make sure that your name, the name of the dealer, the serial number and the year, month and date of purchase are all completed or the original invoice or the sales receipt (indicating the dealer's name, the date of purchase and product type) is attached to this Guarantee Certificate. Olympus reserves the right to refuse free-of-charge service if neither Guarantee Certificate is completed nor the above document is attached or if the information contained in it is incomplete or illegible.
- 2 Since this Guarantee Certificate will not be re-issued, keep it in a safe place.
- * Please refer to the list on the web site: <http://www.olympus.com> for the authorized international Olympus service network.

For customers in Asia

Provisions of warranty

- 1 If this product proves to be defective, although it has been used properly (in accordance with the written Handling Care and Operating instructions supplied with it), during a period of up to one year from the date of purchase this product will be repaired, or at Olympus's option replaced, free of charge. To claim under warranty the customer must take the product and this Warranty certificate before the end of the one year warranty period to the dealer where the product was purchased or any Olympus authorized service station listed in the instructions and request the necessary repairs.
- 2 The customer shall transport the product to the dealer or Olympus authorized service station at his own risk and shall be responsible for any costs incurred in transporting the product.
- 3 This warranty does not cover the following and the customer will be required to pay repair charge, even for defects occurring within the one year period referred to above.
 - a. Any defect that occurs due to mishandling (such as an operation performed that is not mentioned in the Handling Care or other sections of the instructions, etc.)
 - b. Any defect that occurs due to repair, modification, cleaning, etc. performed by anyone other than Olympus or an Olympus authorized service station.
 - c. Any defect or damage that occurs due to transport, a fall, shock, etc. after purchase of the product.
 - d. Any defect or damage that occurs due to fire, earthquake, flood damage, thunderbolt, other natural disasters, environmental pollution and irregular voltage sources.
 - e. Any defect that occurs due to careless or improper storage (such as keeping the product under conditions of high temperature and humidity, near insect repellents such as naphthalene or harmful drugs, etc.), improper maintenance, etc.
 - f. Any defect that occurs due to exhausted batteries, etc.
 - g. Any defect that occurs due to sand, mud, etc. entering the inside of the product casing.
 - h. When this Warranty Certificate is not returned with the product.
 - i. When any alterations whatsoever are made to the Warranty Certificate regarding the year, month and date of purchase, the customer's name, the dealer's name, and the serial number.
 - j. When proof of purchase is not presented with this Warranty Certificate.

- 4 This Warranty applies to the product only; the Warranty does not apply to any other accessory equipment, such as the case, strap, lens cap and batteries.
- 5 Olympus' sole liability under this warranty shall be limited to repairing or replacing the product and any liability for indirect or consequential loss or damage of any kind incurred or suffered by the customer due to a defect in the product, and in particular any loss or damage caused to any film or lenses or other equipment or accessories used with the product or for any loss resulting from delay in repair, is excluded.

Notes:

- 1 This Warranty is in addition to and does not affect the customer's statutory right.
- 2 If you have any queries regarding this Warranty, call any of the Olympus authorized service stations listed in the instructions.

Notes regarding warranty maintenance

- 1 This Warranty will only be valid if the Warranty Certificate is duly completed by Olympus or the dealer. Make sure that your name, the name of the dealer, the serial number and the year, month and date of purchase are all completed.
- 2 Since this Warranty Certificate will not be re-issued, keep it in a safe place.
- 3 Any request for repair by a customer in same country where the product was purchased shall be subject to the terms of the warranty issued by the Olympus distributor in that country. Where the local Olympus distributor does not issue a separate warranty or where the customer is not in the country where the product was purchased the terms of this worldwide warranty shall apply.
- 4 Where applicable, this Warranty is valid worldwide. The Olympus authorized service stations listed in this Warranty will gladly honor it.
 - * Please refer to the appended list for the authorized international Olympus service network.

Disclaimer of Warranty

Olympus makes no representations or warranties, either expressed or implied, by or concerning any content if these written materials or software, and in no event shall be liable for any implied warranty of merchantability or fitness for any particular purpose or for any consequential, incidental or indirect damages (including but not limited to damages for loss of business profits, business interruption and loss of business information) arising from the use of inability to use these written materials or software. Some states do not allow the exclusion or limitation of liability for consequential or incidental damages, so the above limitations may not apply to you.

Trademarks

- IBM is a registered trademark of International Business Machines Corporation.
- Microsoft and Windows are registered trademarks of Microsoft Corporation.
- Macintosh is a trademark of Apple Inc.
- The SDHC/SDXC logo is a trademark.
- Eye-Fi is a registered trademark of Eye-Fi, Inc.
- All other company and product names are registered trademarks and/or trademarks of their respective owners.
- The standards for camera file systems referred to in this manual are the "Design rule for Camera File system/DCF" standards stipulated by the Japan Electronics and Information Technology Industries Association (JEITA).

THIS PRODUCT IS LICENSED UNDER THE AVC PATENT PORTFOLIO LICENSE FOR THE PERSONAL AND NONCOMMERCIAL USE OF A CONSUMER TO (i) ENCODE VIDEO IN COMPLIANCE WITH THE AVC STANDARD ("AVC VIDEO") AND/OR (ii) DECODE AVC VIDEO THAT WAS ENCODED BY A CONSUMER ENGAGED IN A PERSONAL AND NON-COMMERCIAL ACTIVITY AND/OR WAS OBTAINED FROM A VIDEO PROVIDER LICENSED TO PROVIDE AVC VIDEO. NO LICENSE IS GRANTED OR SHALL BE IMPLIED FOR ANY OTHER USE. ADDITIONAL INFORMATION MAY BE OBTAINED FROM MPEG LA, L.L.C. SEE [HTTP://WWW.MPEGLA.COM](http://www.MPEGLA.COM)

The software in this camera may include third party software. Any third party software is subject to the terms and conditions, imposed by the owners or licensors of that software, under which software is provided to you.

Those terms and other third party software notices, if any, may be found in the software notice PDF file stored within the accompanying CD-ROM or at <http://www.olympus.co.jp/en/support/imsg/digicamera/download/notice/notice.cfm>

Powered by ARCSOFT.

SPECIFICATIONS

Camera

Product type	: Digital camera (for shooting and displaying)
Recording system	
Still pictures	: Digital recording, JPEG (in accordance with Design rule for Camera File system (DCF))
Applicable standards	: Exif 2.3, Digital Print Order Format (DPOF), PRINT Image Matching III, PictBridge
3D still image	: MP format
Sound with still pictures	: Wave format
Movie	: MOV H.264 linear PCM
Memory	: Internal memory SD/SDHC/SDXC/Eye-Fi card
No. of effective pixels	: 12,000,000 pixels
Image pickup device	: 1/2.3" CMOS (primary color filter)
Lens	: Olympus lens 5.0 to 25.0 mm, f3.9 to 5.9 (Equivalent to 28 to 140 mm on a 35 mm film)
Photometric system	: Digital ESP metering, spot metering system
Shutter speed	: 4 to 1/2000 sec.
Shooting range	
Normal	: 0.6 m (2.0 ft.) to ∞
Macro mode	: 0.2 m (0.7 ft.) to ∞ (W), 0.5 m (1.6 ft.) to ∞ (T)
Super macro mode	: 0.03 m (0.1 ft.) to 0.6 m (2.0 ft.) (f=6.7 mm (fixed))
Monitor	: TG-820: 3.0" TFT color LCD display, 1,030,000 dots TG-620: 3.0" TFT color LCD display, 460,000 dots
Connector	: Multi-connector (DC-IN jack, USB connector, A/V OUT jack)/ HDMI micro connector (type D)
Automatic calendar system	: 2000 up to 2099
Water resistance	
Type	: Equivalent to IEC Standard publication 529 IPX8 (under OLYMPUS test conditions), available in the following depths. TG-820: 10 m (33 ft.)/TG-620: 5 m (16 ft.)
Meaning	: Camera can normally be used under water at a specified water pressure.

Dust resistance	: IEC Standard publication 529 IP6X (under OLYMPUS test conditions)
Operating environment	
Temperature	: -10 °C to 40 °C (14 °F to 104 °F) (operation)/ -20 °C to 60 °C (-4 °F to 140 °F) (storage)
Humidity	: 30 % to 90 % (operation)/10 % to 90 % (storage)
Power supply	: One Olympus lithium ion battery (LI-50B) or separately sold USB-AC adapter
Dimensions	: TG-820: 101.4 mm (W) × 65.2 mm (H) × 26.0 mm (D) (4.0 × 2.6 × 1.0 in.) (excluding protrusions) TG-620: 98.4 mm (W) × 65.9 mm (H) × 21.9 mm (D) (3.9 × 2.6 × 0.9 in.) (excluding protrusions)
Weight	: TG-820: 206 g (7.3 oz) (including battery and card) TG-620: 167 g (5.9 oz) (including battery and card)

Lithium ion battery (LI-50B)

Product type	: Lithium ion rechargeable battery
Model No.	: LI-50BA/LI-50BB
Standard voltage	: DC 3.7 V
Standard capacity	: 925 mAh
Battery life	: Approx. 300 full charges (varies on usage)
Operating environment	
Temperature	: 0 °C to 40 °C (32 °F to 104 °F) (charging)

USB-AC adapter (F-2AC)

Model No.	: F-2AC-1A/F-2AC-2A/F-2AC-1B/F-2AC-2B
Power requirements	: AC 100 to 240 V (50/60 Hz)
Output	: DC 5 V, 500 mA
Operating environment	
Temperature	: 0 °C to 40 °C (32 °F to 104 °F) (operation)/ -20 °C to 60 °C (-4 °F to 140 °F) (storage)

Design and specifications subject to change without notice.

HDMI, the HDMI Logo and High-Definition Multimedia Interface are trademarks or registered trademarks of HDMI Licensing LLC.

HDMI™
HIGH-DEFINITION MULTIMEDIA INTERFACE

OLYMPUS KOREA CO., LTD.

10F, Olympus Tower A, 114-9, Samsung-dong, Gangnam-gu, Seoul, Korea. 135-090
<http://www.olympus.co.kr> Tel. 1544-3200

OLYMPUS (MALAYSIA) SDN. BHD.

10-8, Menara 1 MK, Kompleks '1 Mont Kiara', No.1, Jalan Kiara, Mont Kiara, 50480
Kuala Lumpur, Malaysia.

Tel:+603-6411 0000/Fax:+603-6411 0003

BRANCHES:

PENANG OFFICE

Suite 3A-6, Level 3A, Wisma Great Eastern
No.25, Lebuh Light, 10200 Penang
Tel:+604 262 2832/ Fax:+604 262 5832

KUCHING OFFICE

Level 6-5A, 6th Floor Menara MAA,
Lot 86, Section 53,
Jalan Central Timur,
93300 Kuching, Sarawak
Tel:+6082 253 885/ Fax:+6082 256 885

<http://www.olympus.com.my>

OLYMPUS

<http://www.olympus.com/>

OLYMPUS IMAGING CORP.

Shinjuku Monolith, 3-1 Nishi-Shinjuku 2-chome, Shinjuku-ku, Tokyo, Japan

OLYMPUS IMAGING AMERICA INC.

3500 Corporate Parkway, P.O. Box 610, Center Valley, PA 18034-0610, U.S.A. Tel. 484-896-5000

Technical Support (USA)

24/7 online automated help:

<http://www.olympusamerica.com/support>

Phone customer support: Tel. 1-888-553-4448 (Toll-free)

Our phone customer support is available from 9 am to 9 pm
(Monday to Friday) ET

<http://olympusamerica.com/contactus>

Olympus software updates can be obtained at:

<http://www.olympusamerica.com/digital>

OLYMPUS EUROPA HOLDING GMBH

Premises: Wendenstrasse 14-18, 20097 Hamburg, Germany
Tel: +49 40-23 77 3-0 / Fax: +49 40-23 07 61

Goods delivery: Bredowstrasse 20, 22113 Hamburg, Germany
Letters: Postfach 10 49 08, 20034 Hamburg, Germany

European Technical Customer Support:

Please visit our homepage <http://www.olympus-europa.com> or call our TOLL FREE NUMBER* : **00800 - 67 10 83 00**
for Austria, Belgium, Denmark, Finland, France, Germany, Italy, Luxembourg, Netherlands, Norway, Portugal, Spain, Sweden, Switzerland, United Kingdom
* Please note some (mobile) phone services providers do not permit access or request an additional prefix to +800 numbers.

For all European Countries not listed and in case that you can't get connected to the above mentioned number, please make use of the following
CHARGED NUMBERS: **+49 180 5 - 67 10 83** or **+49 40 - 237 73 4899**

Our Technical Customer Support is available from 9 am to 6 pm MET (Monday to Friday)

OLYMPUS IMAGING CHINA CO.,LTD.

Customer Support: 400-650-0303 Homepage: <http://www.olympus.com.cn>

Customer Service Center:

A8F, Ping An International Financial Center, No. 1-3,
Xinyuan South Road, Chaoyang District, Beijing
Tel: +86-10-58199199 Fax: +86-10-59761360 Zip: 100027

A,32F Shanghai Industrial Investment Building 18
Cao Xi Road(N), Xuhui District, Shanghai
Tel: +86-21-60823500 Fax: +86-21-60823100 Zip: 200030

Rm.1605-1608, Guangzhou International Electronic tower, No403,
Huan Shi East Road, Guang Zhou
Tel: +86-20-61227111 Fax: +86-20-61227120 Zip: 510095
16F Huamin Hanzun Internation Plaza, No.1, Fuxing Street,
Chengdu
Tel: +86-28-86703531 Fax: +86-28-86703532 Zip: 610016

OLYMPUS HONG KONG AND CHINA LIMITED

Digital Camera Repair Centre
L4207, Office Tower, Langham Place, 8 Argyle Street, Mongkok, Kowloon, Hong Kong
Customer Hotline: +852-2376-2150 Fax: +852-2375-0630
<http://www.olympus.com.hk>