

Your **HTC** Radar 4G

User guide

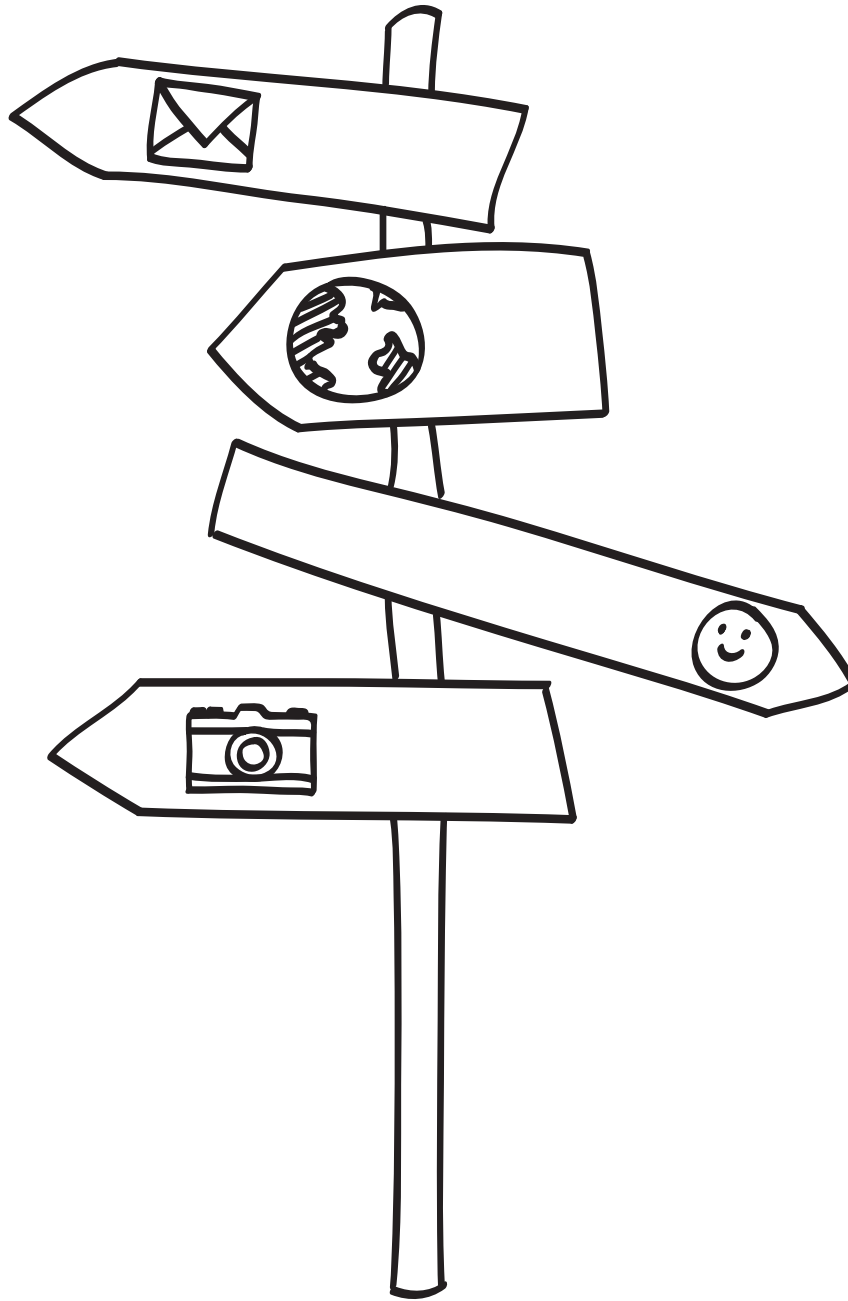

Contents

Getting started

Inside the box	8
Your phone	8
Bottom cover	10
SIM card	12
Battery	13
Switching the power on or off	14
Entering your PIN	14
Finger gestures	14
Setting up your phone for the first time	15
Start screen	15

Basics

Adjusting the volume	17
Sleep mode	17
Lock screen	18
Changing the ringtone	18
Changing the theme	19
Account setup	19
Switching between apps	20
Windows Marketplace	20
Using speech on your phone	20

Phone calls

Making a call	22
Receiving calls	23
What can I do during a call?	23
Starting a conference call	24
Call history	25
Turning airplane mode on or off	26

People

Keeping in touch	27
Importing contacts from your SIM card	27
Adding a new contact	27
Filtering your contacts list	28
Merging contact profiles	28
Searching, editing or deleting	29
Contact groups	30
What is the Me card?	30
Posting to social networks	31
Filtering social updates	32

Keyboard

Using the onscreen keyboard	33
Entering words with predictive text	34
Changing the keyboard language	34

Messaging

Texting and chatting in one place	35
Sharing a picture in a message	36
Viewing and replying to a message	37
Managing conversations	37

Email

Adding your Windows Live account	39
Adding a POP3/IMAP email account	39
Adding a Microsoft Exchange ActiveSync account	40
Checking email	40
Sending email	41
Managing email messages	42
Changing email account settings	43

Camera

Camera basics	44
Taking a photo	45
Recording video	46
Camera flash doesn't turn on?	46
After capturing	47
Taking a panoramic photo	47
Taking continuous photo shots	48

Photos, videos, and music

Pictures	49
Music + Videos	51
HTC Watch	52

Syncing

Why do I need the Zune software?	57
Installing and setting up the Zune software	57
Syncing pictures, music, and videos	58
Setting up wireless sync	59

Internet connections

Data connection	60
Wi-Fi	61
Using your phone as a mobile hotspot	62

Search and Web browser

Searching the Web	64
Scanning codes, tags, and text	64

Opening and navigating web pages	66
What song is this?	67

Maps and location

Location services	69
Bing Maps	69
Local Scout	73

Calendar

What you can do in Calendar	74
Creating a calendar appointment	74
Creating a new to-do task	75
Displaying and syncing calendars	76

More apps

What's HTC Hub?	77
Checking weather	78
Keeping track of your stocks	79
Reading news feeds	81
Working with Notes	82
What's in the Office hub?	84
Xbox LIVE in the Games hub	85

Bluetooth

Connecting a Bluetooth accessory	87
Disconnecting a Bluetooth accessory	87
Unpairing	88

Settings

Attentive phone features	89
Turning Battery Saver on	89
Changing display settings	90
Changing sound settings	90
Changing the language	91
Managing apps and storage	91

Security

Protecting your SIM card with a PIN	93
Protecting your phone with a password	93

Update and reset

How to get and install updates	95
Preparing for a software update	95
Installing an update	96
Factory reset	97

Trademarks and copyrights

Index

Conventions used in this guide

In this user guide, we use the following symbols to indicate useful and important information:



This is a note. A note often gives additional information, such as what happens when you choose to do or not to do a certain action. A note also provides information that may only be applicable to some situations.



This is a tip. A tip gives you an alternative way to do a particular step or procedure, or lets you know of an option that you may find helpful.



This indicates important information that you need in order to accomplish a certain task or to get a feature to work properly.



This provides safety precaution information, that is, information that you need to be careful about to prevent potential problems.

Other helpful resources

For health, safety, and regulatory information, please read the Safety and regulatory guide that's included in the box.

In addition to this user guide, you can find help information, FAQs, and more in www.htc.com/support.

To learn a lot more about using Windows® Phone, open **Help + How-to** on your phone. Or use your web browser and go to windowsphone.com.



Certain Windows Phone features or Microsoft® services may not be available in some countries or regions.

Getting started

Inside the box

You will find the following inside the box:

- Phone
- USB cable
- 3.5mm stereo headset
- Power adapter
- Quick start guide
- Safety and regulatory guide

Your phone

Front panel

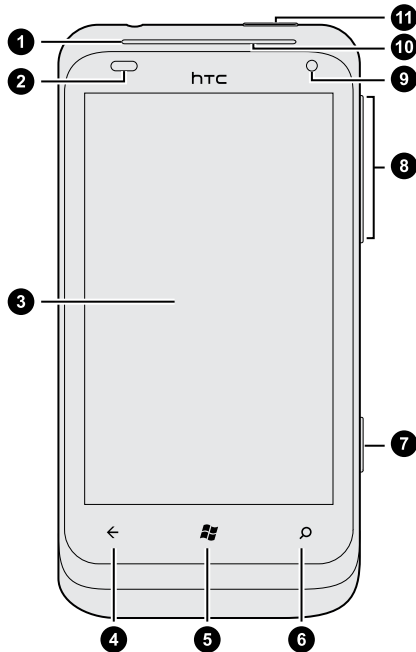

1. Earpiece
2. Light and proximity sensor
3. Touch screen
4. BACK
5. START
6. SEARCH
7. CAMERA
8. VOLUME UP and VOLUME DOWN
9. Front camera
10. Notification LED
11. POWER

Back panel

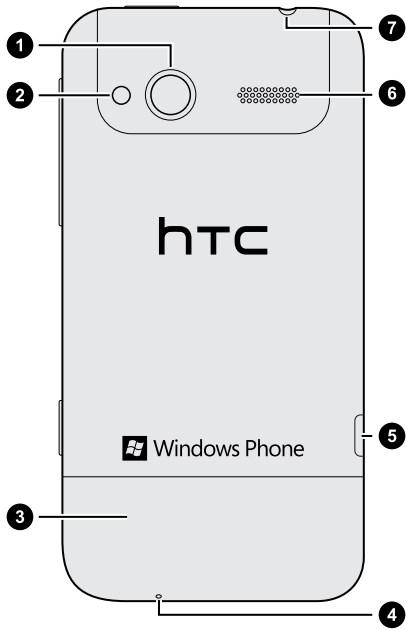

1. 5 megapixel camera
2. LED flash
3. Bottom cover
4. Microphone
5. USB connector
6. Speaker
7. 3.5mm headset jack

Bottom cover

Removing the bottom cover

Remove the bottom cover to access the SIM card slot.



Make sure to switch off your phone before removing the bottom cover.

1. Hold your phone securely upside down with the front facing away from you.
2. With your thumbs, push the bottom cover out to remove it

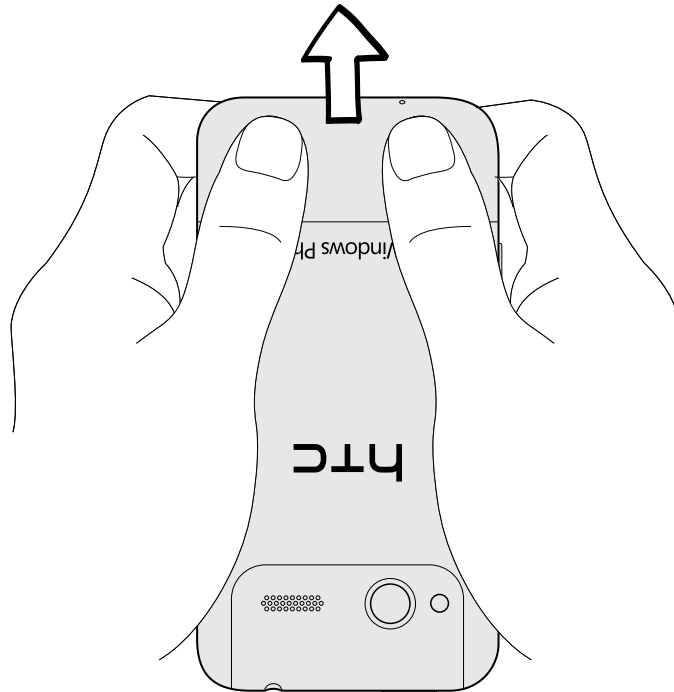

Replacing the bottom cover

1. Align the bottom cover on the bottom of the phone.
2. Push the bottom cover in place. You will hear a click when the bottom cover is locked in place.

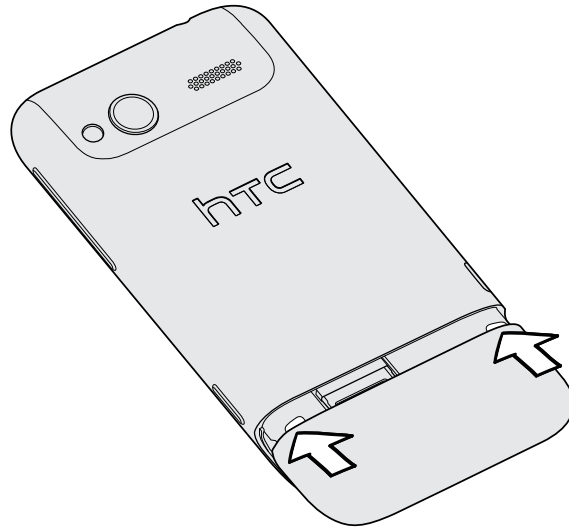

Your phone's antenna is placed underneath the bottom cover. We recommend that you make sure the bottom cover is correctly secured to the phone's back panel to get the best radio reception for your phone.

SIM card

The SIM card contains your phone number, service details, and memory for storing phonebook contacts and/or text messages.

Inserting the SIM card

1. Take the bottom cover off.
2. Insert the SIM card with its gold contacts facing down and its cut-off corner facing out.
3. Push the SIM card all the way in.

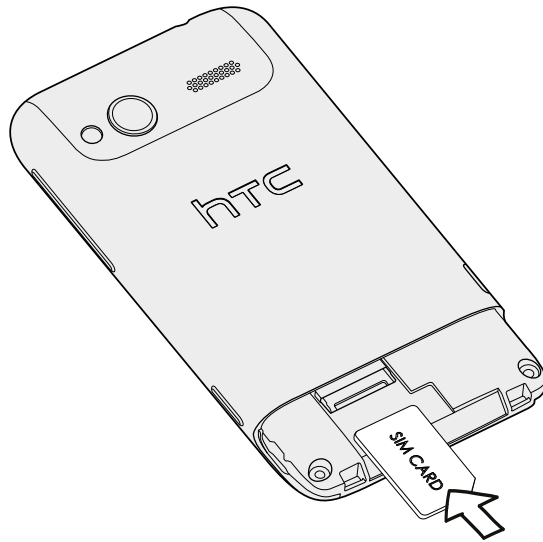

Removing the SIM card



Make sure to switch off your phone before removing your SIM card.

1. Take the bottom cover off.
2. Slide the SIM card out.

Battery

Your phone uses a built-in, rechargeable battery. How long the battery can last before it needs recharging depends on how you use the phone. The features and accessories you use can affect battery life. For example, leaving your Bluetooth® connection always on uses more power. Long phone calls and frequent web browsing use up a lot of battery power. Also, consider your location: poor signal strength from your mobile network and extreme temperature make the battery work harder.

Charging the battery

Before you turn on and start using your phone, it is recommended that you charge the battery.



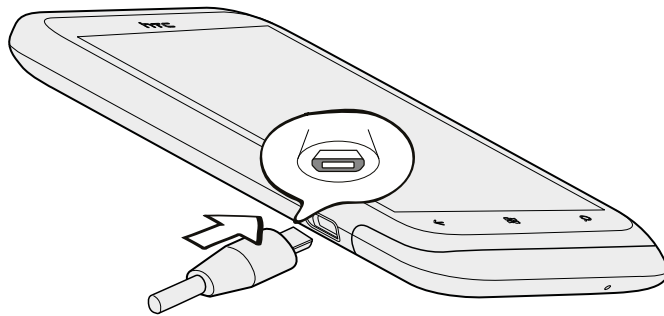

Only the power adapter and USB cable provided in the box must be used to charge the battery.

1. Insert the small end of the USB cable into the USB connector.



2. Insert the other end of the USB cable into the power adapter.
3. Plug in the power adapter to an electrical outlet to start charging the battery.

As the battery is being charged, the notification LED shows a solid orange light. The light turns to solid green when the battery is fully charged.

When you charge the battery and the phone is on, the charging battery icon  is displayed in the status bar. After the battery has been fully charged, the charging battery icon turns to a full battery icon .



As a safety precaution, the battery stops charging when it overheats.

Switching the power on or off

Switching the power on

Press the POWER button. Easy.



When you turn on your phone for the first time, you'll need to set it up.

Switching the power off

1. If the display is off, press the POWER button to turn it back on, then unlock the screen.
2. Press and hold the POWER button until you see the message, `slide down to power off`.
3. Swipe your finger down the screen.

Entering your PIN

Most SIM cards come with a PIN (personal identification number) set by your mobile operator.

If you're asked for a PIN, enter it and then tap **enter**.

Finger gestures

Tap	When you want to type using the keyboard, select items onscreen such as apps and settings, or press onscreen buttons, simply tap them with your finger.
Press and hold	To open the available options for an item (for example, a contact or link in a web page), simply press and hold the item.
Swipe or slide	To swipe or slide means to quickly drag your finger vertically or horizontally across the screen.
Drag	Press and hold your finger with some pressure before you start to drag. While dragging, don't release your finger until you have reached the target position.
Flick	Flicking the screen is similar to swiping, except that you need to swipe your finger in light, quicker strokes. This finger gesture is always in a vertical direction, such as when flicking the contacts or message list.

Rotate	On most screens, you can automatically change the screen orientation from portrait to landscape by turning your phone sideways. When entering text, you can turn your phone sideways to bring up a bigger onscreen keyboard.
Pinch	In some apps, like Pictures or the web browser, you can “pinch” the screen using two fingers (for example, thumb and index finger) to zoom in or zoom out when viewing a picture or web page.



Setting up your phone for the first time

When you switch on your phone for the first time, you’ll be asked to set it up. Just follow the onscreen instructions and you’ll be up and running in no time.

Be sure to sign in with your Windows Live® ID so you can use services such as Hotmail®, Marketplace, Xbox LIVE®, and more.

Start screen

Up front on the Start screen, you’ll see live tiles that continuously update and show what’s most personal to you. You’ll see things like your photo album, how many new messages and email you have, and more.

- Simply swipe your finger up or down to scroll through the tiles.
- On the Start screen, tap  to access apps and settings.
- To return to the Start screen from any app or setting’s screen, press .

Rearranging tiles

1. Press and hold the tile you want to move until it floats.
2. Drag the tile where you want it to go.
3. Keep rearranging until all tiles are where you want them.
4. When you’re done moving tiles, tap anywhere onscreen or press .

Pinning items to the Start screen

You can pin just about anything you want to the Start screen: apps, pictures, songs, favorite websites, documents, and even contacts.

For example, when you pin a contact to the Start screen, you’ll get all of that person’s updates — feeds, email, text messages, and call notifications — right from that tile.

1. To pin something, press and hold it until a menu appears.
2. Tap **pin to start**.

Unpinning a tile

1. Press and hold the tile you want to remove.
2. Tap .

Basics

Adjusting the volume

1. Press the VOLUME UP or VOLUME DOWN button to make the volume bar appear.
2. Keep pressing until you get the volume level that you want.

Silencing your ringer

1. Press the VOLUME UP or VOLUME DOWN button to make the volume bar appear.
2. Tap .

If the **Vibrate** option is on in the settings, your phone will change to vibrate mode. If it's not, your phone will change to silent mode.

Sleep mode

Sleep mode saves battery power by putting your phone into a low power state while the display is off. It also stops accidental button presses when your phone is in your bag or pocket. You'll still receive messages and calls though.

Switching to Sleep mode

Briefly press the POWER button to turn off the display and switch to Sleep mode. Your phone also automatically goes into Sleep mode when it's idle for a while.

Waking up from Sleep mode

To wake your phone up manually, press the POWER button. You'll need to unlock the screen.



Your phone automatically wakes up when you have an incoming call.

Lock screen

Unlocking the screen

Swipe your finger up to unlock the screen or answer an incoming call.



If you've set up a password in the settings, you'll need to enter it to unlock the screen.

Changing your lock screen wallpaper

Browse the collection of preset wallpapers or choose from photos that you've taken with the camera.

1. On the Start screen, tap .
2. Tap **Settings > lock + wallpaper**.
3. Tap **change wallpaper** and then choose a preset wallpaper or a camera photo.
4. If the photo you selected is bigger than the allowable wallpaper size, crop the photo.

To crop, drag the photo and position the part that you want to be your wallpaper inside the crop box, and then tap .

Changing the ringtone

Choose from the preset ringtones.

1. On the Start screen, tap .
2. Tap **Settings > ringtones + sounds**.
3. Tap the **Ringtone** box.

4. Listen to a ringtone by tapping the play icon beside its name.
5. Tap the ringtone you want to use.

Changing the theme

Feeling a little blue? You can change the screen's background and accent colors to match your mood. The accent color you choose will appear in various places, like the tiles on the Start screen, app icons, on web links, in messages, and more.

1. On the Start screen, tap .
2. Tap **Settings** > **theme**.
3. Choose the background and accent colors that you like by tapping their respective boxes.

Account setup

Set up your online accounts such as your Windows Live, Outlook® (Exchange ActiveSync®), and Google® accounts so you can send and receive email.

Depending on the type of email account that you set up, other items such as contacts, calendar, or other information can appear on your phone as well. And when you sign in to your social networking accounts such as Facebook®, you'll also get your friends' status updates and see the pictures they've posted.

Setting up an account

1. On the Start screen, tap .
2. Tap **Settings** > **email + accounts**.
3. Tap **add an account**, and then tap the type of account you want to set up.
4. Enter your email address and password, and then tap **sign in**.

Syncing an account

If you're not seeing your most recent email messages or status updates in an account, you can manually sync the account to download them.

1. On the Start screen, tap .
2. Tap **Settings** > **email + accounts**.
3. Press and hold the account whose information you want to download, and then tap **sync**.

Deleting an account

1. On the Start screen, tap .
2. Tap **Settings** > **email + accounts**.
3. Press and hold the account you want to delete, and then tap **delete**.

Switching between apps

Many apps can run at the same time, and there's an easy way to switch between them all.

1. Press and hold  to see what apps are currently running.
2. Slide left or right across the screen to see all of the open apps, and then tap the one you want to use.

Windows Marketplace

In Windows Marketplace, it's easy to download and purchase apps that fit your needs. A wide collection of free and paid apps is available, from everyday apps, powerful business apps, to fun games. You can also purchase songs.

From the Start screen, tap  > Marketplace and start shopping.

Using speech on your phone

Make a call, send a text, or find a place by simply using your voice.



The speech feature may not be available in some countries.

1. Press and hold .

If this is your first time to use the speech feature, the screen will display some examples of things you can say. After reading the examples, tap **accept** (or tap **speak**).

2. Say an instruction, for example:
 - To call someone in your contact list, you can say `Call Jennifer Singer, mobile`.
 - To open an app such as Calendar, say `Open Calendar`.
 - To search for something on the Web such as pizza parlors, you can say `Find pizza parlors`.
 - If you need help, say `What can I say?` to view or listen to the various types of voice instructions you can use.

Turning on more speech commands

You can turn on additional speech commands in the settings, such as saving and dialing speed dial numbers. You can also set your phone to read aloud text messages and allow you to dictate your reply message without typing.

1. On the Start screen, tap .
2. Tap **Settings** > **ease of access**.
3. Tap the **Speech for phone accessibility On/Off** switch to turn on additional speech commands for phone calls. You'll be able to use these commands:



Save speed dial	To assign a speed dial number
Call <i>number</i>	To call a speed dial number
Turn call forwarding on/off	To turn call forwarding on or off

4. Press  to return to the settings list.
5. Tap **speech**.
6. Make sure the **Play audio confirmations** switch is turned on. This makes your phone speak aloud to inform you of incoming phone calls.
7. To make your phone read text messages to you, tap the **Read aloud incoming text messages** box. Choose whether you want your phone to read text messages all the time, or only when you're using a Bluetooth or wired headset.

Phone calls

Making a call

 Most SIM cards come with a PIN (personal identification number) set by your mobile operator. If you're asked for a PIN, enter it and then tap **OK**. If you enter the wrong PIN three times, your SIM card is blocked. Don't worry. Just contact your mobile operator and ask for the PUK (PIN Unblocking Key).



1. On the Start screen, tap .
2. Tap  to open the keypad.
3. Enter the number you want to call and then tap **call**.

To hang up, tap **end call**.

 If you're ready to hang up but the Phone dialer screen isn't displayed anymore, tap the notification at the top of the screen, and then tap **end call**.



Making an emergency call

In some regions, you can make emergency calls even if you don't have a SIM card installed or your SIM card has been blocked.

1. On the Start screen, tap .
2. Tap  to open the keypad.
3. Dial the emergency number for your locale and then tap **call**.

 If you enabled your password but forgot it, you can still make an emergency call without entering the password by tapping **emergency call** on the lock screen and then dialing the local emergency number.

Making an international call

1. On the Start screen, tap .
2. Tap  to open the keypad.
3. Press and hold the **0** key until the + sign appears.

The plus sign (+) shows that you're making an international call (instead of entering the international access number for the country you're in).

4. Enter the following on the keypad:
 - Country or region code
 - Area code (without the 0 at the beginning)
 - Phone number
5. Tap **call**.

Receiving calls

When you receive a phone call, the **Incoming call** screen appears.

Answering a call

- Tap **answer**.
- Or if the display is off and wakes up when you get a call, slide up from the bottom to unlock the screen first and then tap **answer**.

Rejecting a call

- Tap **ignore**.
- Or if the display is off and wakes up when you get a call, slide up from the bottom to unlock the screen first and then tap **ignore**.

Muting the ringing sound without rejecting the call

Do one of the following:

- Place your phone face down on a level surface.



If your phone is already facing down, it will still ring when there are subsequent incoming calls.

- Press the VOLUME UP or VOLUME DOWN button.
- Press the POWER button to silence the ringer and turn the display off.

What can I do during a call?

When a call is in progress, use the onscreen buttons to turn the speaker on, put the call on hold, and more.

Turning the speaker on during a call



To decrease potential damage to your hearing, do not hold your phone against your ear when the speaker is on.

On the call screen, tap **speaker**.

To turn the speaker off, just tap **speaker** again.

Putting a call on hold

On the call screen, tap **hold**.

To resume the call, tap **hold** again.

Switching between calls

If you're already in a call and accept another call, you can choose to switch between the two calls.

1. When you receive another call, tap **answer** to accept the second call and put the first call on hold.
2. To switch between the calls, tap the bar at the top of the screen.



3. To end the current call and return to the other call, tap **end call**.

Muting the microphone during a call

On the call screen, tap **mute**.

To turn the microphone back on, tap **mute** again.

Starting a conference call

Conference calling with your friends, family, or co-workers is easy. Make the first call (or accept a call), and then simply dial each subsequent call to add it to the conference.



- Make sure your SIM card has conference calling service enabled. Contact your mobile operator for details.
- The maximum number of people you can have on a conference call varies by mobile operator.

1. Make a call to the first conference call participant.
2. When connected, tap **add call**, and then call the second participant.
The first participant is then put on hold.
3. When connected to the second participant, tap **merge calls**.
4. To add another participant, tap **add call**, and then call the person you want to invite.

5. When connected, tap **merge calls**.
6. To have a private conversation with someone in the call, tap **private**, and then tap the person's name or number.
 - Tap **merge calls** to merge the other people back and continue the conference call.
 - Or to end the private conversation, tap **end call**.

To end the conference call, tap **end call**.





Call history

Access the call history to check missed calls, your dialed numbers, and received calls.

Checking calls in the call history

1. On the Start screen, tap .
2. In the **history** list, you can:
 - Press and hold a number or contact name and delete it.
 - Tap a number or contact name to go to the **profile** list where you can choose to return the call, send a text message, save the number (if it's not yet stored in your contacts), and more.

Adding a new phone number from the call history to your contacts

1. On the Start screen, tap .
2. Tap the phone number that you want to save and then tap .
3. Tap  to create a new contact.
4. Edit the number if you need to, select the phone number type, and then tap .
5. Add the contact name and other information and then tap .



You can also save a phone number from the call history to an existing contact.

Clearing the call history

In the **history** list, you can:

Remove a number or name	Press and hold the number or name, and then tap delete item .
-------------------------	----------------------------------------------------------------------

Clear the entire history	Tap  > delete all .
--------------------------	---------------------------------------------------------------------------------------------------------------

Turning airplane mode on or off

In many countries, you are required by law to turn off wireless devices while on board an aircraft. A quick way to turn off wireless functions is to switch your phone to airplane mode.

When you enable airplane mode, all wireless radios are turned off, including the call function, data services, Bluetooth, and Wi-Fi®. When you disable airplane mode, the call function is turned back on and the previous states of Bluetooth and Wi-Fi are restored.

1. On the Start screen, tap .
2. Tap **Settings** > **airplane mode**.
3. Tap the **Status** switch to turn it on or off.

When airplane mode is on, you'll see the  icon in the status bar.

People

Keeping in touch

The People hub is more than just your address book. It's also where you can keep up with your social networks and stay in touch with the people you care about most.

1. On the Start screen, tap **People**.
2. Slide left and right across the screen to access your contacts list and see what's happening with your contacts.



all	Your contacts list. Just tap a contact to call, text, chat, write on a wall, or see that person's updates and pictures. Tap a group to send a group message and see updates and pictures from the group members
what's new	Here's where you can check out your contacts' latest updates, all handily rolled together from your various social network accounts.
recent	Here you'll see and get quick access to the contacts you've viewed or communicated with most recently.

Importing contacts from your SIM card

When you import contacts from your SIM card, they're automatically synced to your Windows Live account. They won't be deleted from the SIM card. If you haven't set up a Windows Live account, your contacts are saved to the memory.

1. On the Start screen, tap **People**.
2. Tap  > settings > import SIM contacts.



Adding a new contact

1. On the Start screen, tap **People**.
2. In the **all** contacts list, tap .
3. Tap **new contact**.
4. Tap the account you want to create the contact in.
5. Tap each item (such as **name**, **phone**, **email**) and then enter the information. After entering information for each item, make sure to tap  to save it.

6. Tap **add photo** to assign a picture or use the camera to take a picture of your contact.
7. When you're done, tap  to save the new contact.

Filtering your contacts list

You can filter the list to show contacts only from the accounts you choose.

1. In People, tap  > **settings**.
2. Tap **filter my contact list**.
3. Select the accounts from which you want to show contacts, and then tap .

Merging contact profiles

In People, you might have two or more versions of the same contact. This is usually because you have the contact's profile on different social network or email accounts. In most cases, your phone will combine contact profiles automatically. For those that are not combined, you can link them manually.

1. Tap a contact that has one or more duplicate entries in the **all** contacts list.
2. Tap .
3. You can:
 - Under **suggested links** (if available), tap the one that you want to link to the contact.
 - Tap **choose a contact** and then tap one that's a duplicate entry.

Unlinking contact profiles

1. In the **all** contacts list, tap the contact that has linked profiles.
2. Tap the link icon that shows the number of links .
3. Under **linked profiles**, tap the one that you want to unlink.
4. Tap **unlink**.

Searching, editing or deleting

Searching for a contact



If your contacts list is especially long, search is probably the quickest way to find a contact.

1. In the **all** contacts list, tap .
2. In the search bar, enter the first few letters of the first or last name of the contact you're looking for.
Matching contacts are then displayed.
3. Tap the contact to view the person's contact information.

Editing a contact's information



Contacts from Facebook, Twitter™, or LinkedIn® cannot be edited. But you can add information, and then save it to a different account (such as Windows Live).

1. In the **all** contacts list, tap the contact whose information you want to change.
2. Tap .
3. If this is a linked contact (someone with multiple accounts that show up as one entry in your contacts list), tap the account you want to edit (for example, tap **edit Windows Live**).
4. Edit or add new information for the contact.
After entering new information for an item, remember to tap  to apply the changes.
5. When you're done, tap  to save the changes.

Deleting a contact



While you can't delete a Facebook, Twitter, or LinkedIn contact on your phone, you can delete contacts from other services. When you do this, the contact will be deleted both from your phone and from the online service where it's stored.

1. In the **all** contacts list, tap the contact you want to delete.
2. Tap  > **delete**.
3. If the contact is a linked contact (someone with multiple accounts), choose which account to remove the contact from.





You can also press and hold a contact and then tap **delete**.

Contact groups

Groups help you cut through social networking clutter to stay in touch with the people who matter most — family, friends, your bowling league. When you create a group, it shows up at the top of your contact list.

Tap it, and you'll see the group members and their social networking updates, along with options for group email, texting, and chat.



Creating a new group

1. On the Start screen, tap **People**.
2. In the **all** contacts list, tap .
3. Tap **new group**.
4. Enter a group name.
5. Tap **add contact** and then choose a contact to add to the group.
Repeat this to add more contacts to the group.
6. When you're done, tap .



Press and hold a group to pin it to the Start screen.

Editing a group

1. Tap the group you want to edit and then tap .
2. You can:
 - Change the group name.
 - Add more contacts to the group.
 - Remove someone from the group. Tap the member, and then tap **remove from group**.
 - Change the preferred contact number or email address for a member. Tap the member, tap the information you want to change, and then tap .

Deleting a group

Press and hold a group, and then tap **delete**.

What is the Me card?

The Me card is your profile. It's also your one-stop shop for social networking. You can access the Me card either from the Start screen or the People hub.

- On the Start screen, tap **Me**.
- On the Start screen, tap **People**. Tap your profile picture.

Here are some things you can do:



- Post a new message on your social networks.
- See, comment on, and like social network posts.
- Reply to or retweet updates on Twitter.
- Update your profile picture on Facebook and Windows Live.
- Set your chat status. Let other people see when you're available on instant messaging.

Posting to social networks





You can post messages to your social networks and comment or like other people's posts. You can also check in to share your location with friends.

Go to **Settings** > **email + accounts** to check what types of social network accounts can be set up on your phone.

Posting a message

1. On the Start screen, tap **Me**.
2. Tap **post a message** and then type your message.
3. If you have more than one social network account, tap the **Post to** text box, choose which accounts to post to, and then tap .
4. Tap .





Commenting or liking someone's post

1. On the Start screen, tap **People**.
2. Slide left or right to go to **what's new** so you can see recent posts from your contacts.
3. When you see a post you want to comment on or like, tap .
4. You can:
 - Tap the box that says **add a comment**, type your comment, and then tap .
 - Tap  to like (or tap  to unlike).

Checking in on Facebook or Windows Live

When you check in to a place, you share your location with your contacts by posting it on one or more of your social networks. You can find nearby locations, or you can add one yourself.

1. On the Start screen, tap **Me**.
2. Tap **check in**.

3. Do one of the following:
 - Tap a place in the list to check in from there.
 - If you don't see your location listed, tap  to make the app find your location. Type the name of the place where you're at, and then tap .
 - To search for a nearby place, tap , type the name of the place, and then tap .
4. Once you've found the place you want to check in from, choose each account you want to check in on.
5. Tap  to check in.

Filtering social updates

Flooded with updates? Try viewing posts from one social network at a time. Or you can hide the updates from one or more of your social networks.

- In People, slide left or right to go to **what's new**. Tap **all accounts**, and then tap the account you want to view posts from.
- Or tap  > **settings**, and then select **Only show posts from people visible in my contact list**.

Posts from the social networks you've filtered out of your contacts list will no longer be visible.

Keyboard

Using the onscreen keyboard

When you start an app or select a field that requires text or numbers, the onscreen keyboard becomes available.

Tap anywhere onscreen where you can type and the keyboard appears automatically.





After you've finished using the keyboard, press ← to close it.

Turning caps lock on

Press and hold or double-tap the shift key . Tap it again to turn caps lock off.

Entering numbers and symbols

1. Tap  to switch to and use the numeric and symbol keyboard. You'll find numbers, common punctuations, and symbols on the keyboard.
2. To use more symbols, tap .
3. Some of the symbol keys can bring up even more symbols. Press and hold a symbol to see more.

For example:

- Press and hold a symbol key such as the left parentheses key, and then slide to another symbol that you want.



- Press and hold the period key to bring up some of the common punctuation options, and then slide to the one that you want.
- Press and hold the \$ key to see more options for currency symbols, and then slide to a currency.

Moving the cursor

To place the cursor in the middle of the text you've already entered, press and hold near the text you want to change until a cursor appears, and then drag your finger to move the cursor exactly where you want it.

Entering words with predictive text



The onscreen keyboard has predictive text to help you type quickly and accurately. Predictive text input is enabled by default, and word suggestions are displayed as you type.

To enter a word in predictive mode:

- If you see the word you want highlighted in bold, just tap the space bar to insert the word into your text.
- If you see the word you want shown in the suggestions before you have finished typing the entire word, tap the word to insert it into your text.
- Slide across the suggestion bar to see more words.
- If you mistyped something or chose the wrong word, just tap that word to display the suggestion bar and choose the right word.

Changing the keyboard language

You can choose between a variety of languages, layouts, and regions for your keyboard. Your phone can provide word suggestions and spelling corrections based on the language you choose.

1. On the Start screen, tap .
2. Tap **Settings** > **keyboard**.
3. Select the languages you'd like to be able to use from the onscreen keyboard. The next time you use the keyboard, you'll see the language key .
4. While using the onscreen keyboard, tap the language key  to switch between the languages you've selected.

Messaging

Texting and chatting in one place

With the Messaging app, you can both text and chat in one place. Whether your friends and family are on their mobile phone or at their computer, you can send them text messages, Windows Live instant messages, or start a Facebook chat.



- To chat on Messenger, you need to set up your Windows Live account first.
- To chat over Facebook, you need to set up your Facebook account. Also, make sure to turn on Facebook chat in the Messaging app's settings.

1. On the Start screen, tap **Messaging**.
2. If you want to send an instant message over Windows Live Messenger, set your chat status first, if you haven't done so.
3. Tap
4. Tap , choose a contact, and then tap the contact's phone number, Messenger, or Facebook to determine how you want to send the message.
Repeat to add more recipients, and their names will be added automatically in the **To** box.
5. Tap the box that says *type a message*, and then enter your text.
6. Tap

When adding recipients, you can also:

- Tap , and then select a contact group. The **Group text** option in the app's settings is turned on by default and can help keep replies in one thread when you're texting with a group of people. When it's turned on, replies are sent as multimedia messages instead of text messages.
- Begin typing a person's name in the **To** box, and then tap a matching contact name. The contact info you choose or enter determines if the message is sent as a text message or instant message over Messenger or Facebook. Repeat to add more recipients.
- Enter a mobile phone number or email address in the **To** box. To enter additional recipients, tap Enter after each one.

Setting your chat status

1. On the Start screen, tap **Messaging**.
2. Tap , and then tap a status.

For example, tap **available** to sign in so that your family and friends will see you online in their Windows Live Messenger.



You can also set your chat status from the Me card.





After you set your chat status and sign in, you'll see who's online in the Messaging app. Tap a contact to send the person an instant message.

Sharing a picture in a message

You can send a multimedia message by attaching a picture to a text message. You can also send a picture in an instant message on Windows Live Messenger or Facebook.





Your mobile operator might charge you extra to send multimedia messages, and this service must be available with your current data plan.

1. On the Start screen, tap **Messaging**.
2. Tap  to create a new message.
3. In the **To** box, fill in the recipient's name, mobile phone number, or email address.
4. Tap . You can:
 - Select an existing photo to attach to your message.
 - Or tap  to take a photo and attach it.
5. Enter your message.
6. Tap  to send.

Viewing and replying to a message

When you receive a new message, you'll hear a notification sound (if set) and see the message briefly display at the top of the screen.



- To open and read the message, you can:
 - Tap the message bar at the top of the screen.
 - Or open the Messaging app to access and read the message.
- Tap , and then choose whether to reply with a text, Messenger, or Facebook message.
- Enter your reply, and then tap .

Why can't I reply to my friend using Facebook or Messenger on the same thread?

If you're friends with someone on Facebook or Messenger, you may have several different contact profiles for the same person. Their phone number, Facebook, and Messenger info may be stored as different contacts on your phone. In this case, you need to link these contacts manually.

Open the People app and link them.

Copying and pasting a message

You can copy a previous message and paste it to the new message you're composing.

- In the **threads** list, tap a contact (or phone number) to display the exchange of messages with that contact.
- Press and hold the message you want to copy, and then tap **copy**.
- Tap the text box where you're composing your new message.
- To paste the copied message, tap .

Managing conversations

Forwarding a message

- In the **threads** list, tap a contact (or phone number) to display the exchange of messages with that contact.
- Press and hold the message you want to forward, and then tap **forward**.

3. Fill in the recipient.
4. Tap  to send.

Deleting a message

1. In the **threads** list, tap a contact (or phone number) to display the exchange of messages with that contact.
2. Press and hold the message you want to delete, and then tap **delete**.

Deleting a whole conversation

In the **threads** list, press and hold a contact (or phone number) whose messages you want to delete, and then tap **delete**.

Email

Adding your Windows Live account

When you first set up your phone, you're asked to sign in with your Windows Live ID. If you didn't sign in then or if you have more than one Windows Live ID, go to the settings to set up your primary Windows Live ID or additional Windows Live IDs.

1. On the Start screen, tap .
2. Tap **Settings > email + accounts**.
3. Tap **add an account > Windows Live**.
4. Enter your Windows Live ID and password, and then tap **sign in**.

Your Windows Live email, contacts, calendar, photos, and feeds will be synced to your phone.



- The first Windows Live account that you set up can't be deleted from your phone.
- If you set up additional Windows Live IDs, photos from these accounts won't be synced to your phone.

Adding a POP3/IMAP email account

1. On the Start screen, tap .
2. Tap **Settings > email + accounts**.
3. Tap **add an account**.
4. Choose the type of email account that you want.
If you don't see it in the account list, tap **other account**.
5. Enter your email address and password, and then tap **sign in**.

Your phone then looks for your account settings, completes the setup, and syncs information from your account.

If what you've set up is your Google Account, your phone will sync and download your Gmail™ as well as your Google contacts and calendar from your account.

If you've set up other POP3 or IMAP accounts, your phone will sync email from those accounts.



If your phone can't find your account settings, go to the advanced setup to enter the incoming and outgoing server and other settings manually. You'll need to get these information from your email provider.

Adding a Microsoft Exchange ActiveSync account

1. On the Start screen, tap .
2. Tap **Settings** > **email + accounts**.
3. Tap **Outlook**.
4. Enter your email address and password, and then tap **sign in**.

If your account settings are found, wait for your phone to finish syncing with your work email, contacts, and calendar.



If your account settings can't be found, follow the onscreen instructions to enter your Exchange ActiveSync account settings manually. Ask your Exchange Server administrator for these settings.

Checking email

After you've set up your email accounts, a new tile for each account will be added to the Start screen.

1. To open an email account, tap its tile on the Start screen.



If you don't see the tile, tap  on the Start screen, and then tap your email account in the apps list.

2. In the **all** email list, scroll up or down to skim through your email messages.

Email messages are neatly grouped into conversations. If there were back and forth replies to an email, tapping that email expands and shows its series of messages.

3. Tap an email message to open and read it.



If you have a long email list, you can also slide left or right to skim through unread, flagged, or urgent email only.

Replying or forwarding email

1. Open and read the email message.
2. Tap .
3. Choose whether to reply only to the sender, reply to all, or forward the email.

Linking inboxes as one

To check your email from all your accounts just in one place without having to switch to different accounts, you can link your inboxes as one.

1. Tap  > **linked inboxes**.
2. Under **other inboxes**, tap one or more email accounts that you want to combine to your unified inbox.

The default name for your unified inbox is **Linked inbox**.



Tap **rename linked inbox** if you want to change the name of your unified inbox.



3. Press  to return to your inbox. You'll now see just one inbox containing all your email from your different accounts.



Next time you want to check your email, tap **Linked inbox** on the Start screen or in the apps list.

Unlinking an inbox

1. Tap  > **linked inboxes**.
2. Under **this inbox**, tap the email account you want to remove from the unified inbox.
3. Tap **unlink**.

Sending email

1. Open the email account that you want to use for sending your email.
2. Tap .
3. Fill in one or more recipients. In the **To** field, you can:
 - Tap  to choose a contact. Tap it again to add more.
 - Start typing a person's name or email address. If there are matches found from your stored contacts as you type, they will be listed. Tap the one that you want.
4. Enter the subject and compose your message.

5. To attach a picture, tap .
6. When you're ready to send your email, tap .



- When entering several email addresses manually, separate them with a semicolon.
- To send a carbon copy (cc) or blind carbon copy (bcc), tap  > **show cc & bcc** and add other recipients.

Setting the priority for an email message

You can set the priority for an email message before sending it.

1. While composing the message, tap  > **priority**.
2. Select the priority for the message.

Saving or discarding the email





1. While composing your email, tap .
2. Choose whether to save your email as a draft or delete it.

Resuming an email draft

1. While in the email list, tap  > **folders** > **drafts**.
2. Tap the draft email to edit it.
3. Send the email.

Managing email messages

Deleting, moving, flagging, or marking several email messages

1. Tap .
2. To quickly select all email messages in a conversation, select the top one (the one that shows the subject and number of messages).
Or to select individual email messages, tap their respective check boxes.
3. Choose what you want to do with the selected messages.
 - Tap  to delete.
 - Tap  to move them to another mail folder.
 - Tap  and choose whether to flag or mark the messages as read or unread.



You can also just tap on the far left of an email to select the email first. Check boxes will then appear and you can select more email messages.



Deleting, moving, flagging, or marking one email

1. Press and hold a conversation or a single message.
2. On the options menu, choose what you want to do with the whole conversation or the single message.

Switching to another mail folder

1. Tap  > **folders**.
2. Tap **show all folders** to see all the available mail folders.
3. Tap the mail folder whose email messages you want to view.

Changing email account settings

1. On the Start screen, tap the email account that you want.
2. Tap  > **settings**.
3. Tap **sync settings** to choose how often to download items or change the items that you want to sync.
4. Choose if you want a signature to appear in your sent email.
5. Tap .

Camera

Camera basics

Whether traveling for business or fun, enjoy taking photos and videos with the camera.

- From the Start screen, tap  > **Camera** to open the Camera app.
- Or press the CAMERA button.

The first time you open the Camera app, you'll be asked whether you want to let it use your location. If you allow this, location information will be stored in your captured photos and you'll be able to know where they were taken. When you share your photos, other people can also see that information.







Did you know you can open the Camera app even if the display is off or locked? Just press and hold the CAMERA button.

Viewfinder screen

You'll find the following onscreen controls on the Viewfinder screen:



	Photo/Video mode switch
	Switch to front or rear camera
	Zoom control
	Settings
	Go to viewer



Flash and other settings are not available when you're using the front camera.

Zooming

Before taking a photo or video, you can first use the onscreen zoom control to zoom in or out of your subject.

Simply tap **+** or **-** on the screen to zoom in or out.

Changing settings

1. Tap  to choose from various settings such as flash mode, resolution, effects, and more.
2. To save your changed settings, tap **Save settings** after you make the change. Otherwise, the camera will return to the default settings the next time you use it.



When you go to **settings > applications > pictures + camera** from the Start screen, you'll find more settings that can change how the CAMERA button functions, where to share photos and videos, and more.

Taking a photo

1. Open the Camera app.
2. Tap .
 - Tap one of the flash icons to set the camera to auto flash, flash on, or flash off.
 - Choose the resolution and other settings you want to use.
3. Hold your phone steady, either vertically (portrait view) or horizontally (landscape view).



If you're taking a photo of a group of people, the camera will automatically recognize faces and adjust the focus. You'll see boxes on people's faces.

4. Before taking the photo, you can zoom in and out first on your subject.
5. To take the photo, you can:
 - Press the CAMERA button halfway down to focus, and then press the button all the way down to take the photo. The camera will auto focus on what's in the center of the screen (or on people's faces) and take the shot.
 - Or tap any point on the screen to focus there and take the photo. The camera will auto focus and apply auto exposure on what you tapped.

The photo will be saved in the **Camera Roll** album of the Pictures hub.

Recording video

You can record videos in either portrait or landscape orientation. For the best viewing experience of your videos, the most ideal way is to capture them in landscape.

1. Open the Camera app.
2. Tap  to switch to video mode. You'll see a video counter on the screen.
3. Tap .
 - Tap one of the light bulb icons to switch the camera light on or off during recording.
 - Choose the resolution and other settings you want to use.
4. Before recording, you can zoom in and out first on your subject.
5. Press the CAMERA button to start recording.

While recording, the camera will always auto focus on what's in the center of the screen if **Continuous Focus** is enabled in the settings.

6. To stop recording, press CAMERA again.

The video will be saved in the **Camera Roll** album of the Pictures hub.

Camera flash doesn't turn on?

Camera flash drains the battery. To save battery power, the camera disables the flash (even when you have set the flash mode to auto flash or flash on) when one of the following occurs:

- **You have an incoming call.**



The flash will be disabled temporarily when you have an incoming call. After the call ends, you'll be able to use the flash again.
- **Battery level reaches 20% or lower.**

Recharge the battery so that the camera can have enough battery power to use the flash.
- **Cold weather may lower battery performance which affects the flash.**

To make sure the camera has enough battery life to power up the flash, keep your phone warm. When not in use, put the phone inside your jacket to keep it warm, and try to avoid sudden temperature changes that may affect battery performance.

After capturing

After taking a photo or video, you can view it and others you've captured without leaving the Camera app. You can also choose what to do with a photo or video, such as upload or send it.

1. While on the Viewfinder screen, press . Or slide your finger on the screen. You'll see the photo or video you last captured.
2. If it's a photo, double-tap or pinch and stretch if you want to zoom in and out of a photo.
If it's a video, just tap the play icon to view the recording.
3. Tap  to see options of what you can do with your photo or video. You can choose to delete it, upload to Facebook or SkyDrive®, and more.
4. Pinch the screen to change to filmstrip view. You can then easily flick left or right onscreen to browse through your photos and videos.
5. To continue capturing, slide your finger left if you're holding the phone horizontally (or slide up if holding the phone vertically) until you're back on the Viewfinder screen.

Taking a panoramic photo

Whether it's the Golden Gate Bridge or the Eiffel Tower, you can capture anything wide or tall in a single photo. The camera lets you take up to three shots to create your panoramic photo.



When you're using panorama mode, zooming, flash, touch focus, and touch capture are not available. Settings such as brightness and exposure are set to auto.



1. While on the Viewfinder screen, tap  > **Panorama Shot**.
2. While pointing the camera on your subject, hold your phone steady. Align the dotted line with the solid line onscreen.

3. When you're ready to capture the first shot, press the CAMERA button.
A message then appears, guiding you in what direction you should move to take the next shot. As you move, directional arrows appear.
4. Using the directional arrows, dotted line, and circles onscreen as your guidance, pan left or right in landscape view (or pan up or down in portrait view). When the ring reaches and centers on the next circle, the camera automatically takes the shot.
5. Do the same thing to take the last shot.

The camera stitches your shots into a single photo.



Press the CAMERA button or tap  anytime if you want to stop taking more shots. The camera stitches only those shots that were captured.

Tap  to view the panoramic photo you've just taken. If you want to delete it and start over, tap  > **delete**.

Press the  button to quit panorama mode and resume the normal photo mode.

Taking continuous photo shots

Is your subject in motion? Use burst mode to take consecutive shots.

1. While on the Viewfinder screen, tap  > **Burst Shots**.



When you're in this mode, flash and touch focus are not available. Other settings such as brightness and exposure are set to auto.

2. Point the camera and focus on your subject.
3. When you're ready to take the photo, press the CAMERA button.

The camera takes five consecutive shots of your subject.



Press the  button to quit burst mode and resume the normal photo mode.

Photos, videos, and music

Pictures

About the Pictures hub

On the Pictures hub, you can view the photos and videos you captured with the camera, flip through online albums (from Facebook and SkyDrive), or catch up with your friends' latest snapshots.

1. On the Start screen, tap .
2. Tap **Pictures**.
3. Slide left or right across the screen and you'll see the following:

picture collection	You can view your pictures and videos by album or date, or see what's on the camera roll. You can also check out your friends' online albums or your own.
favorites	See up to 8 pictures you've tagged as favorites, or tap see all to view the rest. You can even pin your favorites to the Start screen for one-tap access.
what's new	Here you'll find the latest pictures your social networking friends have uploaded. Tap one to post a comment or tag a face.

Adding a photo to your favorites

Some snapshots are so great you just can't get enough of them. To get to these photos quicker, add them to your favorites.

1. On the Pictures hub, find a photo you like and tap to open it.
2. Press and hold the photo, and then tap **add to favorites**.



Before you can add a photo from an online album to your favorites, you need to save it first to your phone. Open the photo, and then tap  > **save to phone**.

Changing the background on the Pictures hub

You can pick out any photo to use as the background on your Pictures Hub — even photos from online albums. Better yet, your Pictures hub can also show a rotating selection of your favorite pictures.

1. On the Start screen, tap .
2. Tap **Pictures**.

3. Tap .
4. You can:
 - Choose a photo to use as the background. Tap **choose background**, select a photo, and crop it.
 - Tap **shuffle background** to just shuffle photos that are tagged as favorites.



If you have the Pictures tile on your Start screen, the background you choose will also show up in the tile.

Sharing

Share photos or videos with your friends and loved ones. You can send a photo in a multimedia message. Or send any photo or video by email. You can also upload a photo or video to your social networking sites.



- Make sure you've signed in to your social networking accounts before uploading.
- You can share photos on SkyDrive, Facebook, or Twitter.
- You can share videos on SkyDrive or Facebook.



1. On the Pictures hub, find and open the photo or video you want to share.
2. Tap  > **share**.
3. Choose how to send it or where you want to share it.

Using Photo Enhancer

Photos need a bit of touch-up? Improve photos taken in poor lighting conditions with one tap. Or apply special effects to give your photos a unique touch.



This app is preinstalled in most phones. If you don't see it on your phone, open the HTC Hub and download this free app.

1. On the Start screen, tap .
2. Tap **Photo Enhancer**.
3. Tap **choose picture**.
4. Open the album where the photo you want to edit is located, and then tap the photo.
5. To see what's available, slide left or right across the thumbnails of the various effects.
6. Tap an effect to apply it to your photo.
7. Tap  to save.

The enhanced photo will be saved in another album called **Saved Pictures**.



Music + Videos

Playing music, videos, and podcasts

Listen to music, catch up on your favorite podcasts on your commute, or enjoy a movie on your next flight.



If you don't have music, videos, or podcasts yet, connect your phone to your computer and use the Zune® software to sync them first to your phone.

1. On the Start screen, tap .
2. Tap **Music + Videos**.
3. Under **zune**, tap **music**, **videos**, or **podcasts**.
4. Slide left or right to different categories (such as artists or albums when browsing through music).
5. Tap the item that you want to play. The playback screen opens and starts to play the music, video, or podcast.
6. Use the onscreen controls to control the playback.
7. When you're done, keep pressing  until you're back on the main screen of the Music + Videos hub.

Listening to FM radio

Tune in to your favorite station or catch the news.



You need to connect a stereo headset first to the audio jack of your phone. Your phone uses it as the FM radio antenna.

1. On the Start screen, tap .
2. Tap **Music + Videos**.
3. Under **zune**, tap **radio**.
4. Press the VOLUME UP or VOLUME DOWN button to show the mini playback controls. Use them to go to the next or previous station, pause, or resume the radio.





When choosing stations, you can also:

- Swipe left or right to go to a radio station.
- If you flick instead of swipe, the radio jumps to the strong stations and skips over weak stations.

Adding or removing a favorite station

To quickly tune into radio stations that you like, add them to your favorites.

1. Tune in to a station.
2. Tap  to add the station as a favorite. To remove from your favorites, tap .

Listening to a favorite station

1. If you've added some favorite stations, tap  to see them.
2. Tap a favorite station in the list.

HTC Watch

About HTC Watch

With the HTC Watch™ online video service, get a glimpse of the latest movie trailers and enjoy watching Hollywood blockbusters or TV shows.



Create your HTC Watch account so you can:

- Rent or purchase videos such as movies and TV shows online.
- Watch your purchased videos on up to five HTC Windows Phone and Android™ devices that have access to HTC Watch using your same account.



- Initially, you may only be able to watch movie trailers. Rental and purchasing services will gradually be available worldwide. Please stay tuned.
- You can watch a rented video only on the HTC device that was used to rent.

Creating or signing in to your HTC Watch account

1. On the Start screen, tap .
2. Tap HTC Watch.
3. Tap  > settings > account.
4. Create a new HTC Watch account, or directly sign in if you already have your account.

Browsing the video store selections

Explore the catalogue of items in the HTC Watch video store. Browse TV shows and movies available for rent or purchase. You can also view trailers for select videos.

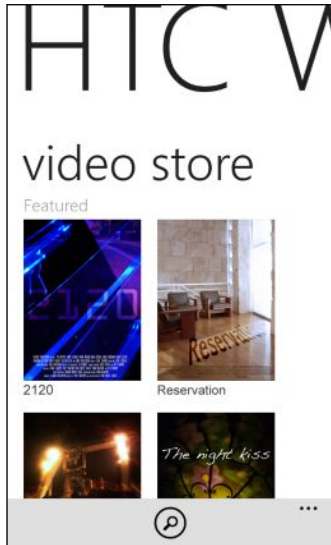

1. In HTC Watch, choose from our featured video selections or browse by category.



To do a quick search, tap and then enter a title, actor name, or director name you're looking for.

2. Tap a video to view its synopsis.

Rent or make a purchase when you're ready.

Watching a trailer

If you see the icon while viewing the synopsis of a video, that means there's a trailer available for that video. Tap it to watch the trailer.

Renting or purchasing a video

Your billing information will be stored on your HTC Watch account so you won't need to enter it every time you rent or purchase.

1. While viewing the synopsis of a video, tap to rent or to purchase the video.
2. If this is your first time to rent or purchase, tap **add a payment method** and then enter your credit card details and billing address.



Make sure to use a credit card that's registered in the same region as the one associated to your HTC Watch account.

3. Confirm your rental or purchase.
4. Tap **play** to start streaming and watch the video.



You can go to your library to check your rentals or purchases and watch them.

Watching videos in your library

1. In HTC Watch, slide left or right to see the following:

recent	Your latest video purchases, rentals, and what you've recently watched.
my library	Your complete library of purchases and rentals. Choose to browse through your library of movies or TV shows.

2. To watch a video, tap it, and then tap .

If you've watched the video before, playback will resume seamlessly from where you left off. You can also jump to any part of the video and start to watch from there.



HTC Watch only keeps track of the last playback position of your 16 recently watched videos.

Checking or changing settings

In HTC Watch, tap  > **settings**.

account	Modify your account settings.
my purchases	Check your purchase history.
payment methods	Edit or delete your credit or debit card info.
device management	<p>When you purchase or rent videos from the video store, your HTC device will automatically be added to your HTC Watch account. If you own more than one HTC device that has access to HTC Watch, you can watch videos on up to five devices.</p> <p>Tap remove if you want to unlink and remove an HTC device from your account.</p>
cache management	<p>When you watch a video for the first time, it is stored in the cache which is a temporary storage. This makes it possible for offline viewing of the video later.</p> <p>You can adjust the cache size to use. Or clear the cache to remove the streamed content.</p>

Sort videos by	Choose whether to arrange the videos in your library by the recent purchase or viewing date or by title.
re-check store region	<p>If you travel to a different region, you can make the app redetect your location to determine the video store region from which you can rent or purchase videos.</p> <p>Once you've confirmed your region during your first purchase, it cannot be changed.</p>

Some useful things to know

Why am I asked to sign in again to my account?

Whenever a time interval (about 20 minutes) has passed, you'll be asked again to sign in to your HTC Watch account before you can continue to rent or purchase videos or access some settings. This is a safety precaution to check your identity and to ensure that you acknowledge that it is your account.

How long is the rental period of a video?

Depending on the studio's terms, the rental period is either 24 or 48 hours, starting from the first viewing.

If you're not immediately watching the video, you have up to 30 days before the rental expires.

Can I edit my credit card info or add a second credit card?

You can only use one card for your purchases. The card number cannot be edited.

In HTC Watch, you can only add one credit or debit card, and you do this the first time you purchase or rent a video. After you've entered and saved your card info, you can make changes to your info but not the card number. If you want to use a different credit or debit card for your payments, you need to delete your current card details and then add a new card.

Why won't HTC Watch allow me to remove a device and add a new one?



Removal is available once every 120 days.

Can I remove my HTC Watch account from my device, and how?

You can remove your account, but this will reset the HTC Watch app and delete all rental licenses. You'll then have to repurchase your rented videos.



Before removing your account, check and make sure that you don't have any rentals that haven't expired.

1. In HTC Watch, tap  > **settings**.
2. If you're asked to sign in again to your account, enter your password, and then tap .
3. Tap **remove account**.

Syncing

Why do I need the Zune software?

Install the Zune software on your computer so you can get the most out of your phone.

Here are the top 3 reasons why you need to install the Zune software:

- To download stuff (such as music, videos, movies, TV shows, podcasts, apps, and games) from Zune Marketplace to your computer.
- To sync stuff between your computer and your phone. This includes the pictures, music, videos, movies, TV shows, and podcasts on your computer that you want to copy to your phone. It also includes the pictures and videos you've taken on your phone that you want to copy to your computer.
- To update your phone software (to get new features, performance enhancements, and so on).



There are a lot of other things you can do with the Zune software. For example, you can use it to rip audio CDs, import an iTunes® library, and find out what music your friends are listening to. For more info, go to Zune.net.

Installing and setting up the Zune software

In most cases, you'll be prompted to install Zune the first time you connect your phone to your computer. If you aren't prompted, download the software from the Web and install it on your computer.

1. On your computer's web browser, go to the [Zune download page](#) and click the download button. Follow the instructions to download and install.
2. After you've finished installing the software, connect your phone to your computer using the supplied USB cable. Zune automatically opens on your computer.
3. Wait for Zune to recognize your phone, and then follow the onscreen instructions to set it up.



Zune cannot be installed and used on a Mac. If you're using a Mac computer, you need to use Windows Phone 7 Connector for Mac to sync multimedia files between your phone and your computer and to download available phone updates. Go to the [Windows Phone 7 Connector for Mac download page](#).

Syncing pictures, music, and videos

After setting up Zune on your computer, choose what you want to sync with your phone.



If you don't have music, videos, or podcasts on your computer yet, get them first from Marketplace.

1. Connect your phone to your computer using the supplied USB cable.
Zune automatically opens on your computer, if you haven't opened it.
2. On top of the Zune screen, click **collection**.
3. Find the item you want to sync. You can:
 - Click a category (music, videos, pictures, or podcasts), and browse until you find the item you want to sync with your phone (such as a song, album, artist, playlist, genre, and so on).
 - In the search box, enter what you're looking for (for example, a song title or artist name). In the search results, click the desired item.
4. Drag the item to the phone icon at the bottom left side of the screen.

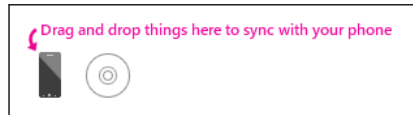

If you have captured photos and videos on your phone, they will automatically be copied to your computer when you sync with the Zune software.

Changing sync options

If you want more control over what gets synced between your phone and computer, try experimenting with the Zune software sync options. For example, if you don't want to bother dragging individual songs, artists, or albums to the phone icon, you can configure the Zune software to auto sync all music on your computer with your phone (space permitting).

1. In the Zune software, click **Settings > Phone > Sync Options**.
2. Click the items that you want to change (for example, in the **Music** section, click **All**), and then click **OK**.

Setting up wireless sync

If you don't want to physically connect your phone to your computer every time you need to sync, you can set up your phone to automatically sync with your computer over your home Wi-Fi network.



Wireless sync is not supported on workplace Wi-Fi networks.

1. Connect your phone to your computer using the supplied USB cable.
2. In the Zune software, click **Settings > Phone > Wireless sync**.
3. Follow the onscreen instructions in the Zune software.

Files on your computer will then auto sync with your phone wirelessly when:

- Your phone battery has at least a medium-level charge  and your phone is connected to the supplied power adapter (that is, your phone must be connected to the wall charger and not connected to your computer).
- You're not interacting with your phone. For example, you're not touching things on the screen, the backlight is off, and music and videos aren't playing.

It might take up to 15 minutes for wireless sync to start, and there is no way to manually force it to occur. For more information about wireless sync, see Zune.net.

Internet connections

Data connection

When you turn on your phone for the first time, it will be automatically set up to use your mobile operator's data connection (if the SIM card is inserted).

Turning the data connection on or off



Turning your data connection off can help save battery life and save money on data charges. However, if you don't have data connection turned on and you're also not connected to a Wi-Fi network, you won't receive automatic updates to your email, social network accounts, and other synchronized information.

1. On the Start screen, tap .
2. Tap **Settings** > **cellular**.
3. Tap the **Data connection On/Off** switch.

Adding a new access point

An access point name (APN) is the address your phone uses to connect to the data network. By default, APNs are set automatically when your phone is first set up. If your cellular data connection isn't working, try entering a new APN based on your location and mobile operator.

 Before adding, have the access point name and settings (including username and password if required) from your mobile operator ready.

1. On the Start screen, tap .
2. Tap **Settings** > **cellular**.
3. Tap **add apn**.
4. Enter the APN and other required settings.
5. Tap  to save.

Enabling data roaming

Connect to your mobile operator's partner networks and access data services when you're out of your mobile operator's coverage area.



Using data services while roaming will be costly. Check with your mobile operator for data roaming rates before you use data roaming.

1. On the Start screen, tap .
2. Tap **Settings** > **cellular**.
3. Tap the **Data roaming options** box, and then tap **roam**.

Wi-Fi

To use Wi-Fi, you need access to a wireless access point or "hotspot". The availability and strength of the Wi-Fi signal will vary depending on objects, such as buildings or simply a wall between rooms, the Wi-Fi signal has to pass through.

Connecting to a Wi-Fi network

1. On the Start screen, tap .
2. Tap **Settings** > **Wi-Fi**.
3. Tap the **Wi-Fi networking On/Off** switch to turn Wi-Fi on.
You'll then see a list of available wireless networks.
4. Tap the wireless network you want to connect to.
 - If you selected an open network, your phone will automatically connect to the network. (Some Wi-Fi networks, such as ones you might find in coffee shops, restaurants, hotels, or elsewhere, may require you to enter a password in your web browser before you can connect.)
 - If you selected a secured network, enter the required password and then tap **done**.

When you're connected to a wireless network, the Wi-Fi connected icon  appears in the status bar and shows you the signal strength (indicated by the number of bands that light up).

The next time you connect to the same secured wireless network, you won't be asked to enter the password or other security information again, unless you do a factory reset.

Connecting to a hidden Wi-Fi network

A Wi-Fi network might be hidden, which means the network name isn't broadcasted. In this case, it won't appear in the list of available networks on the **Wi-Fi Settings** screen and a notification won't appear when the network is in range. To connect to a hidden Wi-Fi network when it's in range, you'll need to enter the network name and password.



The network name and password are case sensitive.

1. On the Start screen, tap
2. Tap **Settings** > **Wi-Fi**.
3. Make sure that Wi-Fi is turned on.
4. Tap **advanced**.
5. Tap enter the network name, and then tap **add**.
6. On the **Sign in** screen, enter the password, and then tap **done**.

Disconnecting from a Wi-Fi network

1. On the Start screen, tap .
2. Tap **Settings** > **Wi-Fi**.
3. Tap the **Wi-Fi networking On/Off** switch to turn Wi-Fi off and disconnect from the wireless network.

You can also press and hold the network name and then tap **delete** to disconnect. But this removes the security settings if it's a secured network, and you'll need to enter them again next time you reconnect to this Wi-Fi network.

Using your phone as a mobile hotspot

Want to share your Internet connection with your laptop or another device? You can turn your phone into a mobile hotspot by sharing your cellular data connection over Wi-Fi. Other Wi-Fi enabled devices can then use your shared data connection to connect to the Internet.



- To share your cellular data connection, this feature must be available from your mobile operator and enabled on your current phone plan. This is also known as tethering and often costs extra.
- When you and other people use the shared connection on another device, it uses data from your cellular data plan. Please be aware of any data limits you have on your plan, so you don't get charged extra.

1. On the Start screen, tap .
2. Tap **Settings** > **Internet Sharing**.

3. Tap the **Sharing On/Off** switch to turn Internet Sharing on.
4. Tap **setup**, and then change these settings:

Broadcast name	Enter a name for your mobile hotspot. This is the name that other people will see and use to connect to your shared connection over Wi-Fi.
Security type	Select password required (WPA2) to set up your mobile hotspot as a secured network. Or select none (open) to grant access to anyone.
Password	If you chose password required (WPA2) , enter a password that's required to connect to and use your shared connection.

5. Tap  to save your settings.

When you tap the top of the screen to see the status bar, you'll see the Internet Sharing icon  while you're sharing your cellular data connection.



Search and Web browser

Searching the Web

Just press the search button on your phone to search the Web using Bing®.



Some web search features may not be available in certain countries.

1. Press . The Bing Search screen opens.
2. Tap the search box, enter what you want to search for, and then tap  on the keyboard.
3. Slide left or right across the screen to narrow or broaden the search results to web, local, or images.



Under the **web** results, scroll up or down to see different kinds of results, such as news, related searches, apps, products, flight status, and more. The types of results displayed will depend on what you've entered and searched for.

Scanning codes, tags, and text



Want to scan something? Using Vision search, you can use the camera to scan lots of things you see, and then search for those things on the Web.

You can scan QR Codes and Microsoft Tags that you see in magazines, online, on signs, or anywhere else. You can also scan text to search, have it translated, and paste scanned text into a message.





The items you can scan and search for vary by country or region.



Scanning a QR Code

1. Press .
2. On the Bing Search screen, tap .
3. Point the camera at the QR Code you want to scan.
You'll then see the Results screen.
4. Tap the result to get info about the QR Code. The information that appears depends on the QR Code and can be a message, contact info, email address, website, or phone number.

Scanning a Microsoft Tag

1. Press .
2. On the Bing Search screen, tap .
3. Point the camera at the Microsoft Tag you want to scan.
You'll then see the Results screen.
4. Tap the result to get info about the Tag.

Searching by scanning a barcode, book, CD, or DVD cover

1. Press .
2. On the Bing Search screen, tap .
3. Point the camera at the barcode, book cover, CD cover, or DVD cover you want to scan.
You'll then see the Results screen.
4. Tap the result to get info from the Web about the item you've just scanned.

Searching by scanning text





You can scan text and then search the Web using the scanned words. Or you can have the text translated.

1. Press .
2. On the Bing Search screen, tap .



- Point the camera at the text you want to scan, and then tap **scan text**.
- You can:

Search the Web.	Tap each of the squares that contain the words you want to search for, and then tap search .
See a translation for text that's recognized.	Tap translate , and then choose a language.

Copying and pasting scanned text

- Press .
- On the Bing Search screen, tap .
- Point the camera at the text to scan, and then tap **scan text**.
- Tap  > **copy all**.
- Open the file, app, or message where you want to paste the text.
- Tap where you want to paste the text.
- In the text suggestion bar above the keyboard, tap the paste icon .

Selecting from previous image search results

- Press .
- On the Bing Search screen, tap .
- Tap **history**.
- On the Vision history screen, tap a past result.

Opening and navigating web pages



Internet Explorer® Mobile makes it quick and easy to surf the Web on the go. By using tabs, you can open multiple web pages and switch between them quite easily.

Opening a web page

- On the Start screen, tap **Internet Explorer**.
- Tap the address bar, and then enter a web address. As you type, Internet Explorer will suggest possible matches.
- If you see the site you're looking for, tap it. Or tap  on the onscreen keyboard.

Using tabs to open multiple web pages

You can open up to six separate browser windows (called "tabs" in Internet Explorer) simultaneously. Tabs make it easy to hop between sites.

1. In Internet Explorer, tap  > **tabs**.
2. Tap  to open a new tab. A blank browser screen then opens.
3. On the new browser screen, go to a website that you want.

Switching between tabs

1. In Internet Explorer, tap  > **tabs**.
2. Tap the thumbnail that shows the website you want to open.

If you no longer need to view a website, you can close the tab by tapping .

Sharing a link

When you see a website that you like, you can easily tell your friends about it by sharing its link. You can send the link in your text or email message. Or post it in your social networks.

1. While viewing the website in Internet Explorer, tap  > **share page**.
2. Choose how you want to share the link.

If you chose to share the link in your social networks, enter your message, select which networks to post on, and then tap .



What song is this?

Songs you hear on the radio, or when you're out and about, don't need to be a mystery anymore. You can search for music that's playing to find out more about it, such as the song title, artist, album, and ways to listen to or buy it.



- Music search can only recognize recorded music. Music from live performances or humming can't be recognized.
- Music search may not be available in certain countries.

Searching for recorded music that's playing



1. Press . The Bing Search screen opens.
2. With the music playing, hold your phone where you can clearly hear the music, and then tap .

After scanning, the song title, artist, album name, and album art will appear for songs that are recognized.

3. To find the song in Marketplace, tap **Marketplace**. You can then preview that song and other ones on the album, and also buy if you want to.

Selecting from previous music search results

You can go back and find music that you've searched for in the past.

1. Press .
2. On the Bing Search screen, tap  > **music history**.
3. On the **Music history** screen, tap a song to find it on Marketplace.

Maps and location

Location services

Turning on location services

You can choose to turn on location services to allow apps to use your location information and provide you with a richer experience. For example, your GPS location can be stored on the photos that you take with the Camera app. And if you're not sure where you are, Bing Maps can find and display your location.

1. On the Start screen, tap .
2. Tap **Settings** > **location**.
3. Tap the **Location services On/Off** switch to turn it on.

Apps for which you enable location services can now access your current location.

Bing Maps

About Bing Maps

Bing Maps can show you where you are, find the address or place you're looking for, and give you directions to reach your destination. It can also show you nearby stores or restaurants you might be interested in and what other people are saying about them.



- You need to connect to the Internet to use Bing Maps.
- Certain features of Bing Maps may not be available in some countries or regions.



Moving around the map

1. Drag your finger in any direction to view other areas of the map.
2. To zoom in, spread your thumb and forefinger apart on the map. To zoom out, pinch your fingers together.
3. Double-tap the map to automatically center and zoom in on a spot. Double-tap again to get even closer.





Finding your location



Before you can find your location and see it on the map, you need to turn on location services in the settings first (if you declined when the Maps app asked to access and use your location).

1. On the Start screen, tap .
2. Tap Maps. The app tries to find your location and display it on the map.
3. If the displayed location on the map isn't quite accurate, tap  to find your location again.

Finding an address or place

1. On the Start screen, tap .
2. Tap Maps.
3. Tap .
4. In the search box, enter any of the following:
 - An address
 - A zip or postal code
 - A city
 - A business name or type
 - An intersection
 - A point of interest
5. Tap  on the onscreen keyboard.
6. To get more info about the place, tap the pushpin  on the map.



You may see several pushpins on the map if there are several results found.

What are pushpins?

Pushpins are handy for remembering places you want to visit, getting directions, or sharing location info. They're automatically shown on the map when you search for places. You can also manually add a pushpin.

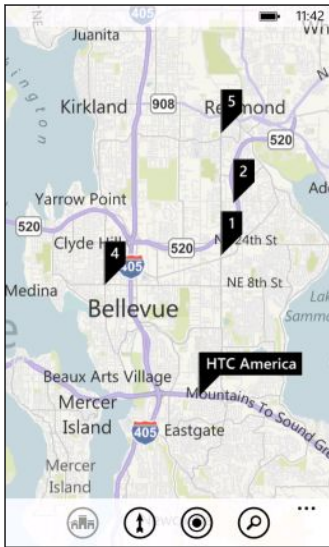

When you tap a pushpin **1** for a store, restaurant, or other point of interest, the **about** screen opens and displays additional info, such as the street address, directions, phone number, hours, web address, and customer reviews. You can choose what to do with the location info, such as pin to your Start screen, add to your favorites, or share it.

Adding a pushpin

While viewing your map, press and hold on the spot where you'd like to add a pushpin.

Viewing pushpins as a list

If several pushpins are shown on the map after you've done a search, you can display them as a list to see in detail the search results.

While viewing the map, tap **⋮** > **search results**.

Sharing an address

Need to tell someone where to meet you? Send the address in a text or email message, so the person you're meeting with can see it on a map or get directions.

1. In Maps, search for the location you want to share.
2. Tap the pushpin of that location.
3. On the **about** screen, tap **📧**.
4. Choose how you want to share the address.

Getting directions

Get detailed directions to your destination. When viewing directions in Maps, you'll see the total distance and estimated travel time to help you plan ahead.



Certain features such as turn-by-turn voice directions may not be available in some countries or regions.

1. While viewing a map, tap .
2. Use your current location as the starting point, or enter another location in the **Start** field. And in the **End** field, enter your destination.

In these fields, you can enter:

- an address
- a restaurant, store, or other business name



Maps then displays a split screen, showing a map with the planned route on top and the list of directions at the bottom.

3. Tap  to see driving directions, or tap  for walking directions.

When you scroll through the list of directions, the map auto refreshes to show the direction.

4. Maps automatically announces the next turn or direction while you're approaching it. If you want to listen to the voice instruction before the turn or direction, just tap it in the list. (Or if you're driving, have one of your passengers do it for you.)
5. When you reach your destination, tap it to display the location information.



While viewing directions, press  to view the map in full screen so you can see the route and pan on the map. To see the list of directions again, tap  > **directions list**.

Local Scout

About Local Scout





New to the area or just looking for something new to do? Local Scout can help you find nearby restaurants, shops, and things to do. You can get relevant info about the different places to help you decide where to go.

Finding nearby places in your current location

1. On the Start screen, tap **Local Scout**.
Bing Maps then finds your location and displays nearby places you can go to on the Local Scout screen.
2. Slide left or right across the screen to view the various suggested places that are listed under these categories: **eat + drink**, **see + do**, **shop**, and **highlights**.
3. Tap a place to get more info.
4. While viewing the list of places (such as restaurants under **eat + drink**), tap the map at the top of the screen to see where these places are on the map.

Finding places in another area

You can use Local Scout to find places in any other area and plan your trip ahead of time. For example, if you're taking a trip to another city, use Bing Maps first to search for the city, and then use Local Scout to find places in that area.

1. On the Start screen, tap .
2. Tap **Maps**.
3. Tap .
4. In the search box, enter a city name.
5. Tap  on the onscreen keyboard.
6. Tap .

Changing how Local Scout searches

By default, Local Scout narrows the search by distance from your current location or a location that you specified. If you're looking for restaurants or stores, you can set Local Scout to search by ranking or category.

1. In Local Scout, tap **distance** below **eat + drink** or **shop**.
2. Tap the **I care about** box, and then choose a type you're interested in. For example, you can tap **highest rated** to look for restaurants or stores that other people highly recommend.
3. Press  to see the new search results.

Calendar

What you can do in Calendar

Never miss an important date again. You can sync your existing calendars from your email accounts to your phone and see them in the Calendar app. You can also add new appointments, create your to-do list, and respond to invitations that people send you.

- After you've set up your email accounts such as Windows Live, Outlook (Exchange ActiveSync), and Google, the calendars associated with your accounts will be synced to your phone.



If you haven't set up your email accounts, see [Email](#) on page 39 to find out how to add them to your phone.

When you create new appointments on your phone, they will be synced to the calendars in your accounts.

- If you've set up a Facebook account, you'll see your Facebook events in the Calendar app. You can only view and not create or edit Facebook events on your phone.

Creating a calendar appointment

When creating a new appointment, you can choose which account's calendar to add it to.

1. On the Start screen, tap **Calendar**.
2. In **day** or **agenda** view, tap .
3. If you have more than one calendar, tap the **Calendar** box, and then select an account in which to add the appointment.
4. Enter the appointment details.
5. At the bottom of the screen, tap **more details** to set a reminder, appointment's occurrence, and more.
6. Tap  to save.

Quickly creating an appointment on a time slot

If you don't need too much detail on your appointment, you can quickly create an appointment by just selecting a time slot and typing a subject right on the calendar.

1. In the Calendar app, go to **day** view.
2. Tap a time slot, enter a subject, and then tap .

Later, you can just edit the appointment if you need to add more details or move it to another account's calendar.

Sending an invitation

You can use Calendar to schedule a meeting or an appointment and invite people to attend it. An invitation email will be sent to them from the account that you choose.



You can only invite contacts that are stored or synced on your phone.

1. In Calendar, create a new appointment.
2. Tap the **Calendar** field, and then choose the account to use for sending the invitation.
3. Add details, such as date and time, location, and more.
4. Tap **more details**, scroll down the screen, and then tap **add someone**.
5. Invite required and optional attendees. Tap **add someone**, and then tap the name of the person to invite.
6. Tap  when you're done.

Creating a new to-do task

To-dos show up on your calendar, and they appear alongside your appointments.



You can only create to-dos in Windows Live and Outlook (Exchange ActiveSync) accounts.

1. In the Calendar app, swipe left or right to go to the **to-do** list.
2. Tap .
3. If you have more than one account, choose the account in which to add your to-do task.
4. Fill in the details for your task, such as subject, due date, and more.

5. To set a reminder, turn **Reminder** on, and then choose a date and time.
6. Tap  to save.

If you've set a due date, you'll see your to-do task in that date's **agenda** view. You'll also see your to-do task in the **day** view of your set reminder date and time.

Displaying and syncing calendars

You can choose which calendars to show or hide in the Calendar app, and which ones to keep synchronized.

Showing or hiding calendars



1. In **day** or **agenda** view, tap  > **settings**.
2. Tap the on/off switch for each calendar that you want to show or hide.



The calendars are kept synchronized on your phone, whether or not you hide them.

Choosing which calendars are synced on your phone

You can choose which calendars to keep synchronized on your phone.

1. On the Start screen, tap .
2. Tap **Settings** > **email + accounts**.
3. Tap the account whose calendar sync setting you want to change.
4. Select or clear the **Calendar** check box, depending on whether you'd like to sync or stop syncing the account's calendar.
5. Tap  to apply the changes.

More apps

What's HTC Hub?

HTC Hub is where you can check out weather forecasts, stock updates, and news. It's also the place to go to find out what free HTC apps you can download from Windows Marketplace.

You'll find free apps ranging from useful everyday tools to games and fun apps that pass the time. Visit the HTC Hub from time to time to check for new additions and updates.

Downloading an app in HTC Hub

1. From the Start screen, tap  > **HTC Hub**.
2. Slide left or right until you see the **featured** apps.
3. If you don't see any app that you like, tap **Get more**. On the next screen, slide left or right to check what other apps and games are available for download.
4. Tap an app to view details.
5. While viewing the details, slide left or right to see more information such as reviews, screenshots, and other related apps.
6. Depending on the app you selected (free or paid app), you can download and install it for free, try it out, or buy it.

You can also share the link and tell your friends about the app.

Checking weather

Should I bring an umbrella today? In HTC Hub, check what the weather's like before you head out.

1. On the Start screen, tap .
2. Tap HTC Hub.

You'll see the weather clock showing the weather for your current location. You'll also see a list of other cities and their weather conditions.



3. Tap the weather clock to open the weather screen where you can see more detailed weather forecasts for your location. Or tap another city to check its weather forecasts.
4. On the weather screen, tap the icons at the bottom to view in full screen, check hourly weather, or check weather forecasts for the upcoming days.





- To refresh the weather info onscreen, tap  > **refresh**.
- Not seeing your current location's weather forecast? Return to the Start screen and go to **Settings > location** to check whether **Location services** is turned on.

Adding a city

1. On the weather clock screen in HTC Hub, scroll down the list to check what cities have already been added.
2. To add a new city, tap .
3. Enter the name of a city or country.
As you type, a list of possible locations are shown based on the letters you entered.
4. Tap the city that you want to add.



Changing the order of cities

1. On the weather clock screen in HTC Hub, tap  > **edit**.
2. Press and hold  at the end of the item you want to move.
3. When the selected city is highlighted, drag it to where you want it to appear in the list.
4. Tap **done**.

Deleting cities

1. On the weather clock screen in HTC Hub, tap  > **edit**.
2. Tap each city you want to delete.
3. Tap **done** to delete them.

Changing the temperature scale and other settings

1. In HTC Hub, tap the weather clock to open the weather screen.
2. Tap  > **settings**.
3. Under **Temperature scale**, select **Fahrenheit** or **Celsius**.
4. Turn on or off weather sound effects and other options.
5. Press  to apply the new settings.

Keeping track of your stocks

Get the latest updates for the stock quotes and market indices that you follow in HTC Hub.

1. On the Start screen, tap .
2. Tap HTC Hub.
3. Flick left to go to the stocks list.



4. If there's a long list, swipe your finger up or down to browse through the stocks that you're following.
5. Tap an item to see a stock's trade information and price chart for the current day.
6. Tap another period if you want to check the stock's past trade information. For example, tap **5D** to check the trade information for the past 5 days.

Want instant updates to just one stock quote or index?



Easy. Just pin the stock quote or index to your Start screen.

1. On the Start screen, tap .
2. Tap **HTC Hub**.
3. Flick left to go to **stocks**.
4. Press and hold a stock quote or index that you want to place on your Start screen, and then tap **pin to start**.



A live tile for your chosen stock quote or index will be added to your Start screen.



Adding a stock quote or stock market index

1. While viewing stocks, tap .
2. Enter a stock quote or market index that you want, and then tap . Matched results will be listed.
3. Tap the stock quote or market index you want to add.

Changing the stock list order

1. While viewing stocks, tap  > **edit**.
2. Press and hold  at the end of the item you want to move.
3. When the selected item is highlighted, drag it to where you want it to appear in the list.
4. Tap **done**.



Deleting stock quotes or indices

1. While viewing stocks, tap  > **edit**.
2. Tap each stock quote or index you want to delete.
3. Tap **done** to delete them.

Changing the price rise color and other settings







Downloading stock information automatically may incur extra data fees.

1. While viewing a stock's trading chart and other details, tap  > **settings**.
2. Change the color for displaying stock price increases to either red or green, depending on what's being used in your country.
3. Choose other options such as the update schedule, and more.
4. Press  to apply the new settings.

Reading news feeds



Don't get left behind with yesterday's stories. In HTC Hub, subscribe to news feeds that cover breaking news, sports, top blogs, and more.

Subscribing to news channels

1. On the Start screen, tap .
2. Tap HTC Hub.
3. Slide left or right until you see the list of subscribed **news** channels.
4. To subscribe and add a news channel, tap .
5. You can:
 - Tap a category such as **Blogs** or **Entertainment**, and then select one or more channels to subscribe to. After you've finished selecting, press  twice to return to the list of subscribed channels.
 - Or tap  to search for a specific keyword or a feed URL. Select one or more channels to subscribe to, and then tap .

Reading a story

1. Tap a subscribed news channel to see only the stories from that channel, or tap **All items** to see the stories from all your subscribed channels.
2. Tap a story that you want to read.
3. While reading the synopsis, you can:

Tap	To
	Go to the web page where the story is published to read the full article.
	Share the link to the story from the available options.
	Go to the previous or next story.

Want instant updates to a subscribed news channel?

Just pin your favorite news channel to the Start screen.

In the list of subscribed news channels, press and hold your favorite channel, and then tap **pin to start**.

A live tile for your favorite channel will be added to your Start screen, and it will show the headline of the latest story.

Unsubscribing news channels

- To unsubscribe a single news channel, press and hold that channel, and then tap **unsubscribe**.
- To unsubscribe several channels, tap  > **unsubscribe**.

Working with Notes



Note to self – pick up flowers for wife before going to dinner. Use the Notes app to create short reminders to yourself.



This app is preinstalled in most phones. If you don't see it on your phone, open the HTC Hub and download this free app.

Creating a note

1. On the Start screen, tap .
2. Tap **Notes**.

3. To create a new note, tap .
4. Enter your note and then tap .



You can also tap the sticky note image at the lower left of the Notes screen to create a new note.

Browsing through your notes

- You can browse your last few notes on the bulletin board.

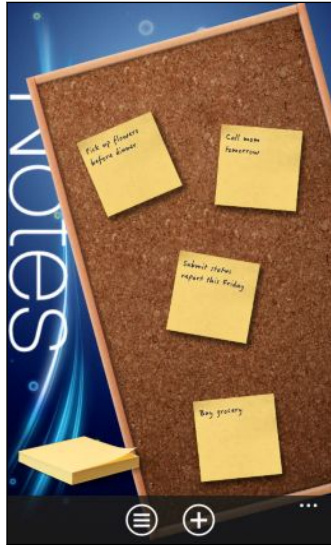

- Or tap  to see all your notes in list view. Swipe up or down to scroll through your notes.

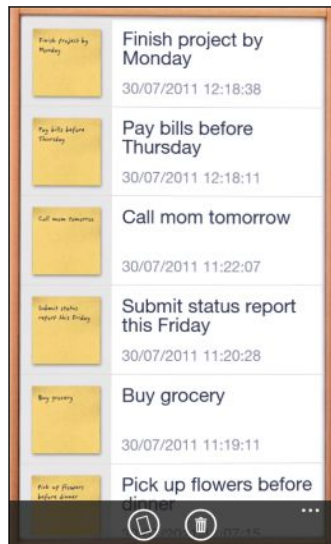

You can also swipe left or right to switch between the bulletin board and list view.

Moving a note around the bulletin board

1. Press and hold a note until it floats.
2. Drag the note to where you want to put it on the bulletin board, and then release it.



Editing a note

1. On the bulletin board or in list view, tap a note to open it.
2. Tap the note again to edit it.
3. Tap  to save your changes.

Deleting a note

1. On the bulletin board or in list view, tap the note you want to delete.
2. Tap .

Deleting multiple notes

1. Tap  to go to list view.
2. Tap .
3. Select the notes you want to delete, and then tap **done**.

What's in the Office hub?

Microsoft Office Mobile includes mobile versions of Microsoft Office applications. You'll find them in the Office hub.

1. On the Start screen, tap .
2. Tap Office.
3. Slide left or right across the screen to see your documents and other stuff.

notes	View, open, search, and edit your notes using OneNote® Mobile. Use your notes to keep track of what's going on at home, work, or school while you're on the go.
documents	Find, open, or create Excel®, PowerPoint®, and Word documents. Any documents you recently saved (from an email, for example) appear here as well.
locations	Access your Office documents that are stored online, such as in SkyDrive, a Microsoft SharePoint® site, or Office 365 site.

What types of files can be opened in Office Mobile?

Office Mobile app	File formats
OneNote Mobile	.one
Word Mobile	.doc, .docx, .dot, .dotx, .dotm, .docm .txt, .rtf
Excel Mobile	.xls, .xlsx, .xlt, .xltx, .xltm, .xlsm, .xltm
PowerPoint Mobile	.ppt, .pptx, .pps, .ppsx, .pptm, .ppsm

Xbox LIVE in the Games hub

Gaming on your phone is a truly social experience. With Xbox LIVE, Microsoft's gaming service, play games with your friends and use your avatar and gamer profile to keep track of game scores and achievements online through the Games hub.



Xbox LIVE or Marketplace may not be available in some countries or regions.

1. On the Start screen, tap **Games**.
2. Slide left or right across the screen and check what games are available.

collection	View all Xbox LIVE and other games that you have on your phone in one place. Just tap a game to start playing. You can also download more games from Marketplace.
Xbox LIVE gamer profile	Sign in to your Xbox LIVE account from here. You'll then be able to check or edit your profile, see your game achievements, and even personalize your avatar.
requests	View invitations to quickly jump into game play, keep up with turn notifications in a turn-based game or accept a nudge from your buddy to make the next move.
spotlight	Read up on Xbox LIVE game news, tips, and trends from the Xbox LIVE team.



From the Games hub, you can also connect to and extend your gaming experience to your computer and your Xbox console.

Downloading and installing Xbox LIVE Extras

Customize your avatar on the go with Xbox LIVE Extras. You can download this app for free.

1. On the Games hub, slide left or right to go to **Xbox LIVE**.
2. Tap your avatar image. Your phone then searches Marketplace for the Xbox LIVE Extras app.
3. Follow the onscreen instructions to download and install the app.

Tap **create avatar** (or **avatar**) and start customizing your avatar.

Bluetooth

Connecting a Bluetooth accessory

You can connect a variety of Bluetooth accessories such as headsets, car kits, or speakers to your phone.



- To listen to music, use an accessory such as a Bluetooth stereo headset that supports the A2DP profile.
- Before connecting, make sure to set the accessory to discoverable. To find out how, please refer to the accessory's manual.

1. On the Start screen, tap .
2. Tap **Settings** > **Bluetooth**.
3. Tap the **On/Off** switch to turn Bluetooth on. Your phone becomes discoverable. It also automatically searches for Bluetooth devices within range.
4. Tap the name of the accessory that you want to pair with your phone.
5. If auto pairing fails, enter the pairing code supplied with the accessory.

When the accessory is connected to your phone, the Bluetooth icon appears on the status bar. You can also check the connection status shown below the accessory name on the **Bluetooth Settings** screen.



Turn Bluetooth off when not in use to save battery power, or in places where using a wireless device is prohibited, such as on board an aircraft and in hospitals.

Disconnecting a Bluetooth accessory

1. On the Start screen, tap .
2. Tap **Settings** > **Bluetooth**.
3. Tap the accessory to disconnect it.

To reconnect, just tap the accessory again.

Unpairing

If you no longer want to use a connected accessory with your phone, you can unpair and remove it from your phone.

1. On the Start screen, tap .
2. Tap **Settings** > **Bluetooth**.
3. Press and hold the name of the accessory, and then tap **delete**.

Settings

Attentive phone features

When your phone rings or during a call, it can sense and automatically respond to your actions or environment. You can go to the settings to find out what smart features your phone has in store for you.

1. On the Start screen, tap .
2. Tap **Settings** > **attentive phone**.
3. You'll find these settings:

Quiet ring on pickup	Lowers the ring volume automatically when you hold and pick up your phone.
Pocket Mode	Makes your phone ring louder when it's in your pocket or bag so you won't miss calls. When your phone is not in your pocket or bag, it rings at the normal volume you've set.
Flip for speaker	Turns the speaker automatically when you flip your phone over during an ongoing call.
Flip to mute ringer	Silences the ringer automatically when you flip your phone over.

If there's any setting you'd like to disable, just clear its check box.

Turning Battery Saver on

When you turn Battery Saver on, your phone automatically turns off some services or features that use battery in the background.

1. On the Start screen, tap .
2. Tap **Settings** > **battery saver**.
3. If you want Battery Saver to turn on whenever the battery gets to 20%, select **Always turn on Battery Saver when battery is low**.
4. If you want to turn on Battery Saver now and leave it on until the next time you recharge the battery, select **Turn on Battery Saver now until next charge**.

Changing display settings

Adjusting the screen brightness manually

1. On the Start screen, tap .
2. Tap **Settings** > **brightness**.
3. Tap the **Automatically adjust On/Off** switch to turn it off.
4. Select the **Level** of brightness to use.

Setting the time delay before the screen turns off

After a period of inactivity, the screen turns off automatically to save battery power. You can set the idle time before the screen turns off.

1. On the Start screen, tap .
2. Tap **Settings** > **lock + wallpaper**.
3. Tap **Screen times out after**, and then select the time length that you want.

Changing sound settings

Setting your phone to silent mode

When you keep pressing the VOLUME DOWN button until the volume level reaches zero, this makes your phone vibrate only. To be able to switch your phone to silent mode using the VOLUME DOWN button, you need to turn vibrate off in the settings.

1. On the Start screen, tap .
2. Tap **Settings** > **ringtones + sounds**.
3. Tap the **Vibrate On/Off** switch to turn vibrate off.

Choosing notification sounds

Choose different sounds for different types of notifications. You can use different sounds for incoming text or chat messages, voicemail, and email notifications.



1. On the Start screen, tap .
2. Tap **Settings** > **ringtones + sounds**.
3. Tap the box for each notification type, and then choose a sound to assign to it. You can also turn on or off notification sounds for reminders and actions such as keypress, camera shutter, and more.

Enhancing your sound experience

Get that surround sound feeling when you're watching videos or listening to music.



Sound enhancements are not available when you're using a Bluetooth stereo headset.

1. On the Start screen, tap .
2. Tap **Settings** > **sound enhancer**.
3. Under **Audio** and **Video**, select a sound enhancement you want to use (such as SRS) for music and for video.
4. If you connected a wired headset or an external speaker, you can choose from various preset equalizer settings for enhancing music. As for video, you can choose 5.1 surround sound.
5. Press  to apply the new settings.

Changing the language

The first time you set up your phone, it prompts you to choose a language. You can change the language setting at any time. Changing the language adjusts the keyboard layout, date and time formatting, and more.



Available languages vary by region.

1. On the Start screen, tap .
2. Tap **Settings** > **region + language**.
3. Tap the **Display language** box, and then choose the language that you want.
4. Tap the underlined text that says to accept changes and restart your phone.

Managing apps and storage

Checking phone info and storage

You can find out various information about your phone such as the Windows Phone update version, available storage, and more.

1. On the Start screen, tap .
2. Tap **Settings** > **about**. You'll see your phone's name and model as well as the total storage and available storage.
3. Tap **more information** (or **more info**) to see the Windows Phone update version and other details.

Changing application settings

In most cases, you can change the settings for an app only when you're inside that app. For some apps, you can change their settings without having to open the apps.

1. On the Start screen, tap .
2. Tap **Settings**.
3. Flick left to go to **applications**.
4. Tap an app or category to see what settings are available and choose the settings that you want.

Uninstalling an app

If you're running out of storage, free up some space by uninstalling apps you no longer need or don't often use.

Deleting an app removes it from your phone. It also removes any information the app contained. So please remove it with care.



Most of the preinstalled apps cannot be uninstalled.

1. On the Start screen, tap .
2. Press and hold an app, and then tap **uninstall**.

Security

Protecting your SIM card with a PIN

Add another layer of security for by assigning a PIN (personal identification number) to your SIM card.



Make sure you have the default SIM PIN provided by your mobile operator before continuing.

1. On the Start screen, tap .
2. Tap **Settings**.
3. Flick left to go to **applications**, and then tap **phone**.
4. Tap the **SIM security On/Off** switch to turn it on.
5. Enter the default SIM card PIN, and then tap **enter**.
6. To change the SIM card PIN, tap **Change SIM PIN**, and then enter a new PIN.

Restoring a SIM card that has been locked out

If you enter the wrong PIN more times than the maximum number of attempts allowed, your SIM card will become “PUK-locked.”



You need a PUK code to restore access to your SIM card. This code may have been provided by your mobile operator when you received your SIM card.

1. On the Phone dialer screen, enter the PUK code, and then tap **enter**.
2. Enter the new PIN you want to use, and then tap **enter**.
3. Enter the new PIN again, and then tap **enter**.

Protecting your phone with a password

Protect your personal information and prevent others from using your phone without your permission by setting a password.

You'll be prompted for your password every time your phone is turned on or when it's been idle for a certain period of time.

1. On the Start screen, tap .
2. Tap **Settings > lock + wallpaper**.

3. Tap the **Password On/Off** switch to turn it on.
4. Enter your password in both the **New password** and **Confirm password** boxes.
5. Tap **done**.

Update and reset

How to get and install updates

From time to time, software updates may be available. Your phone can check and notify you if there's a new update.

Although your phone notifies you "over the air" (through your phone's Internet connection) when an update is available to download, the actual software update is not carried out over the air. You need to connect your phone to your computer to download and install an update.

Setting the type of connection to use for checking updates

Check if your phone has been set to notify you about new updates. Also choose the type of connection you want to use for checking updates.

1. On the Start screen, tap .
2. Tap **Settings** > **phone update**.
3. Make sure the **Notify me when new updates are found** check box is selected.
4. Choose whether to allow the use of your phone's data connection to check for updates. If you disable the use of the data connection, your phone will only check for updates over Wi-Fi or when it's connected to your computer.

Preparing for a software update

To make sure a software update can be carried out smoothly and without interruptions, prepare your phone and computer first for the update. Here are some tips on what you need to check and prepare.

- If your battery level is low, give your phone a quick charge before starting the update.
- Check how much free space you have on your phone and make some room for the update. To find out how to check the available storage, see [Checking phone info and storage](#) on page 91.

If necessary, remove a few unwanted apps. Refer to [Uninstalling an app](#) on page 92 to see how it's done.

Or delete large files (such as photos, videos, or music) from your phone.

- Make sure you have Zune installed on your computer. You'll need it to download the software update. For details, see [Installing and setting up the Zune software](#) on page 57.

- Free up space on your computer.
You'll need some room to download the software update, to save a backup of your existing phone software and settings, and possibly to sync media files from your phone to your computer.
- Make sure your computer has a reliable Internet connection.
In some cases, you might need to switch from a Wi-Fi connection to a wired connection. Or you might need to adjust your computer's firewall or proxy settings.
- Make sure your phone is set with the correct date and time. This determines which new updates you'll need. For details, see [Correcting the date and time](#) on page 96.

Installing an update

When you see the notification about an available software update, you can do the update right away. Or you can dismiss the notification and update some other time. Your phone will remind you again in a few days.



Have you prepared your phone and computer for the update? If you haven't, please see [Preparing for a software update](#) on page 95 on what you should check and prepare.

1. Connect your phone to your computer.
2. Open the Zune software (or Windows Phone 7 Connector for Mac), if it doesn't open automatically.
3. Click **Update Now** (or **Install Updates**).
4. Make sure you keep your phone connected to your computer until you see a notification that the update is complete.

Correcting the date and time

If you're having trouble installing a software update, your phone may not have been set with the correct date and time. In most cases, the date and time is set automatically. But if it's not, you can set it manually.

1. Disconnect your phone from your computer.
2. On the Start screen, tap .
3. Tap **Settings > date + time**.
4. Turn off **Set automatically**.
5. Set the correct time zone, date, and time.
6. Reconnect your phone to your computer, and then try installing the update again.

Factory reset

Do a factory reset to change your phone back to its original state before the first time you turned it on.

If you're passing your phone on to someone else or your phone has a persistent problem that cannot be solved, you can perform a factory reset (also called a hard reset). Factory reset is not a step to be taken lightly. It'll permanently delete all your data and customized settings, and will remove any apps you've downloaded and installed. Be sure to back up any data and files you want to keep before you do a factory reset.

Performing a factory reset via settings

The most convenient way to do a factory reset is via the settings.

1. On the Start screen, tap .
2. Tap **Settings** > **about**.
3. Tap **reset your phone**, and then tap **yes**.

Performing a factory reset using phone buttons

If you can't turn your phone on or access settings, you can still perform a factory reset by using the phone's buttons.

1. Turn the power off.
2. Press and hold the VOLUME UP and VOLUME DOWN buttons, and then press and hold the POWER button. Release these buttons when your phone turns on and displays a text screen.
3. Keep pressing the VOLUME DOWN button until the **Factory reset** option is highlighted, and then press the POWER button.
4. Follow the instructions onscreen to proceed with the factory reset.

Trademarks and copyrights

©2011 HTC Corporation. All Rights Reserved.

HTC, the HTC logo, the HTC quietly brilliant logo, HTC Radar, and HTC Watch are trademarks of HTC Corporation.

Microsoft, Windows, Windows Phone, ActiveSync, Bing, Excel, Hotmail, Internet Explorer, OneNote, Outlook, PowerPoint, SharePoint, SkyDrive, Windows Live, Windows Phone Marketplace, Windows Media, Windows Vista, Xbox LIVE, and Zune are either registered trademarks or trademarks of Microsoft Corporation in the United States and/or other countries.

Google, the Google logo, and Gmail are trademarks of Google Inc.

The *Bluetooth*[®] word mark and logos are registered trademarks by Bluetooth SIG, Inc. and any use of such marks by HTC Corporation is under license.

Wi-Fi[®] is a registered trademark of the Wireless Fidelity Alliance, Inc.

All other company, product and service names mentioned herein are trademarks, registered trademarks or service marks of their respective owners.

Screen images contained herein are simulated. HTC shall not be liable for technical or editorial errors or omissions contained herein, nor for incidental or consequential damages resulting from furnishing this material. The information is provided “as is” without warranty of any kind and is subject to change without notice. HTC also reserves the right to revise the content of this document at any time without prior notice.

No part of this document may be reproduced or transmitted in any form or by any means, electronic or mechanical, including photocopying, recording or storing in a retrieval system, or translated into any language in any form without prior written permission of HTC.

Index

Symbols

3G

- access point 60
- roaming 61
- turning on or off 60

A

Access point 60

Airplane mode 26

Appointment

- creating 74

Apps

- downloading in HTC Hub 77
- managing 91
- settings 92
- switching between apps 20
- uninstalling 92

B

Battery 13

Battery Saver 89

Bing Maps

- finding an address or place 70
- getting directions 72
- sharing an address 71

Bing Search 64

Bluetooth 87

Browser 66

C

Calendar 74

Call history 25

Camera

- geotagging 44
- settings 45

Chat 35

Check in

- Facebook 31
- Windows Live 31

Conference call 24

Contacts

- about 27
- adding 27
- adding a new number from call history 25
- deleting a contact 29
- deleting a contact group 30
- editing 29
- groups 30
- importing from SIM card 27
- merging 28
- searching 29

D

Data connection

- access point 60
- roaming 61
- turning on or off 60

Date and time

- regional format 91
- setting manually 96

Delete

- account 19
- contact groups 30
- contacts 29
- Start screen tile 16

Display

- adjusting screen brightness 90
- setting delay before screen turns off 90

Download apps 20

E

Email

- deleting 42
- Exchange ActiveSync 40
- inboxes 41
- moving 42
- POP3/IMAP 39
- sending 41
- settings 43
- Windows Live 39

Emergency calls *22*
 Exchange ActiveSync email *40*

F

Facebook
 - chatting *35*
 - checking in *31*
 - profile *30*
 - setting up *19*
 - sharing photos and videos *50*

Factory reset *97*
 Firmware updates *96*
 Flight mode *26*
 FM radio *51*

G

Games hub *85*
 Google Account *19*

H

Hands free *87*
 Hard reset *97*
 Home screen *15*
 HTC Hub *77*
 HTC Watch *52*

I

International calls *22*
 Internet connection
 - data connection *60*
 - Wi-Fi *61*

Internet Sharing *62*

L

Language setting *91*
 Local Scout *73*
 Location services *69*
 Lock screen *18*

M

Maps
 - finding an address or place *70*
 - getting directions *72*
 - sharing an address *71*

Marketplace *20*
 Master reset *97*

Messaging
 - deleting or forwarding messages *37*
 - replying to a message *37*
 - sending a message *35*
 - sharing a photo *36*

Microsoft Office Mobile *84*

Microsoft Tag *65*

MMS *36*

Mobile hotspot *62*

Music

- downloading *57*
 - FM radio *51*
 - playing *51*
 - syncing *58*

Mute microphone in a call *24*

N

News feeds *81*
 Notes *82*
 Notification sounds *90*

O

Office hub *84*
 Online accounts *19*
 Outlook email *40*

P

Pairing *87*
 Password lock *93*
 People *27*
 Phone
 - answering or rejecting a call *23*
 - call history *25*
 - conference calling *24*
 - emergency calls *22*
 - international calls *22*
 - making a call *22*
 - mute *24*
 - PIN code *14*
 - speakerphone *23*
 - switching between call *24*

Phone information *91*

Phone updates *96*

Photos

- geotagging *44*
 - sharing *36, 50*

- syncing 58
- viewing 49

Pictures 49

PIN code 14

Podcasts

- downloading 57
- playing 51

Power

- sleep mode 17
- switching on or off 14

Profile

- Facebook 30
- Windows Live 30

Pushpins 71

Q

QR Code 65

R

Radio 51

Regional setting 91

Reset 97

Ringer 17

Ringtone

- changing 18
- volume 17, 90

Roaming 61

S

Screen

- adjusting screen brightness 90
- setting delay before screen turns off 90
- unlocking 18
- wallpaper 18

Search

- contacts 29
- scanned items 64
- Web search 64

Silent mode 17, 90

SIM card

- assigning PIN 93
- contacts 27
- entering PIN 14
- inserting 12
- removing 12

SkyDrive

- sharing photos and videos 50

Sleep mode 17

Software updates 96

Sounds

- flip for speaker 89
- flip to mute ringer 89
- notifications 90
- pocket mode 89
- quiet ring on pickup 89
- ringtone 18
- silent 17, 90
- volume 17, 90

Speakerphone 23

Speech commands 20

Start screen

- about 15
- adding items 15
- personalizing 19
- rearranging items 15
- removing items 16

Stocks 79

Storage space 91

Switch phone on or off 14

Sync

- email sync settings 43
- options 58
- photos, videos, and music 58
- wireless 59
- Zune 57

T

Text messages 35

Themes 19

To-do task

- creating 75

Translation 64

Turn phone on or off 14

V

Vibrate 17

Videos

- downloading 57
- HTC Watch 52
- renting or purchasing 53
- sharing 50
- syncing 58
- watching 49, 51

Voice commands *20*

Volume *17, 90*

W

Wallpaper *18*

Weather *78*

Web Browser *66*

Wi-Fi

- about *61*

- connecting *61*

- disconnecting *62*

- hidden network *62*

Windows Live

- chatting *35*

- checking in *31*

- profile *30*

- setting up *19, 39*

Wireless sync *59*

X

Xbox LIVE *85*

Z

Zune *57*