

**SABERTOOTH
Z77**

ASUS[®]

Motherboard

Copyright © 2012 ASUSTeK COMPUTER INC. All Rights Reserved.

No part of this manual, including the products and software described in it, may be reproduced, transmitted, transcribed, stored in a retrieval system, or translated into any language in any form or by any means, except documentation kept by the purchaser for backup purposes, without the express written permission of ASUSTeK COMPUTER INC. ("ASUS").

Product warranty or service will not be extended if: (1) the product is repaired, modified or altered, unless such repair, modification of alteration is authorized in writing by ASUS; or (2) the serial number of the product is defaced or missing.

ASUS PROVIDES THIS MANUAL "AS IS" WITHOUT WARRANTY OF ANY KIND, EITHER EXPRESS OR IMPLIED, INCLUDING BUT NOT LIMITED TO THE IMPLIED WARRANTIES OR CONDITIONS OF MERCHANTABILITY OR FITNESS FOR A PARTICULAR PURPOSE. IN NO EVENT SHALL ASUS, ITS DIRECTORS, OFFICERS, EMPLOYEES OR AGENTS BE LIABLE FOR ANY INDIRECT, SPECIAL, INCIDENTAL, OR CONSEQUENTIAL DAMAGES (INCLUDING DAMAGES FOR LOSS OF PROFITS, LOSS OF BUSINESS, LOSS OF USE OR DATA, INTERRUPTION OF BUSINESS AND THE LIKE), EVEN IF ASUS HAS BEEN ADVISED OF THE POSSIBILITY OF SUCH DAMAGES ARISING FROM ANY DEFECT OR ERROR IN THIS MANUAL OR PRODUCT.

SPECIFICATIONS AND INFORMATION CONTAINED IN THIS MANUAL ARE FURNISHED FOR INFORMATIONAL USE ONLY, AND ARE SUBJECT TO CHANGE AT ANY TIME WITHOUT NOTICE, AND SHOULD NOT BE CONSTRUED AS A COMMITMENT BY ASUS. ASUS ASSUMES NO RESPONSIBILITY OR LIABILITY FOR ANY ERRORS OR INACCURACIES THAT MAY APPEAR IN THIS MANUAL, INCLUDING THE PRODUCTS AND SOFTWARE DESCRIBED IN IT.

Products and corporate names appearing in this manual may or may not be registered trademarks or copyrights of their respective companies, and are used only for identification or explanation and to the owners' benefit, without intent to infringe.

Offer to Provide Source Code of Certain Software

This product may contain copyrighted software that is licensed under the General Public License ("GPL") and under the Lesser General Public License Version ("LGPL"). The GPL and LGPL licensed code in this product is distributed without any warranty. Copies of these licenses are included in this product.

You may obtain the complete corresponding source code (as defined in the GPL) for the GPL Software, and/or the complete corresponding source code of the LGPL Software (with the complete machine-readable "work that uses the Library") for a period of three years after our last shipment of the product including the GPL Software and/or LGPL Software, which will be no earlier than December 1, 2011, either (1) for free by downloading it from <http://support.asus.com/download>;

or

(2) for the cost of reproduction and shipment, which is dependent on the preferred carrier and the location where you want to have it shipped to, by sending a request to:

ASUSTeK Computer Inc.
Legal Compliance Dept.
15 Li Te Rd.,
Beitou, Taipei 112
Taiwan

In your request please provide the name, model number and version, as stated in the About Box of the product for which you wish to obtain the corresponding source code and your contact details so that we can coordinate the terms and cost of shipment with you.

The source code will be distributed WITHOUT ANY WARRANTY and licensed under the same license as the corresponding binary/object code.

This offer is valid to anyone in receipt of this information.

ASUSTeK is eager to duly provide complete source code as required under various Free Open Source Software licenses. If however you encounter any problems in obtaining the full corresponding source code we would be much obliged if you give us a notification to the email address gpl@asus.com, stating the product and describing the problem (please do NOT send large attachments such as source code archives etc to this email address).

Contents

Safety information.....	vi
About this guide.....	vii
SABERTOOTH Z77 specifications summary.....	ix

Chapter 1: Product introduction

1.1	Welcome!.....	1-1
1.2	Package contents.....	1-1
1.3	Special features.....	1-2
1.3.1	Product highlights.....	1-2
1.3.2	“Ultimate COOL!” Thermal Solutions.....	1-3
1.3.3	“TUF ENGINE!” Power Design.....	1-4
1.3.4	“Safe & Stable!” Guardian Angel.....	1-4
1.3.5	ASUS EZ DIY.....	1-5
1.3.6	ASUS Exclusive Features.....	1-5
1.3.7	Other special features.....	1-6

Chapter 2: Hardware information

2.1	Before you proceed.....	2-1
2.2	Motherboard overview.....	2-2
2.2.1	Motherboard layout.....	2-2
2.2.2	Central Processing Unit (CPU).....	2-4
2.2.3	System memory.....	2-5
2.2.4	Expansion slots.....	2-12
2.2.5	Jumper.....	2-14
2.2.6	Onboard switch.....	2-15
2.2.7	Onboard LEDs.....	2-16
2.2.8	Internal connectors.....	2-17
2.3	Building your computer system.....	2-26
2.3.1	Additional tools and components to build a PC system.....	2-26
2.3.2	CPU installation.....	2-27
2.3.3	CPU heatsink and fan assembly installation.....	2-29
2.3.4	DIMM installation.....	2-30
2.3.5	Motherboard installation.....	2-31
2.3.6	Thermal Armor for ASUS SABERTOOTH Z77.....	2-33
2.3.7	ATX Power connection.....	2-36
2.3.8	SATA device connection.....	2-37
2.3.9	Front I/O Connector.....	2-38
2.3.10	Rear panel connection.....	2-39
2.3.11	Audio I/O connections.....	2-41
2.3.12	USB BIOS Flashback.....	2-43

Contents

2.4	Starting up for the first time.....	2-44
2.5	Turning off the computer.....	2-44

Chapter 3: BIOS setup

3.1	Knowing BIOS.....	3-1
3.2	BIOS setup program.....	3-1
	3.2.1 EZ Mode.....	3-2
	3.2.2 Advanced Mode.....	3-3
3.3	Main menu.....	3-5
3.4	Ai Tweaker menu.....	3-7
3.5	Advanced menu.....	3-20
	3.5.1 CPU Configuration.....	3-21
	3.5.2 PCH Configuration.....	3-23
	3.5.3 SATA Configuration.....	3-24
	3.5.4 System Agent Configuration.....	3-26
	3.5.5 USB Configuration.....	3-27
	3.5.6 Onboard Devices Configuration.....	3-28
	3.5.7 APM.....	3-30
	3.5.8 Network Stack.....	3-31
3.6	Monitor menu.....	3-32
3.7	Boot menu.....	3-37
3.8	Tool menu.....	3-39
	3.8.1 ASUS EZ Flash 2 Utility.....	3-39
	3.8.2 ASUS O.C. Profile.....	3-39
	3.8.3 ASUS SPD Information.....	3-40
3.9	Exit menu.....	3-41
3.10	Updating BIOS.....	3-42
	3.10.1 ASUS Update utility.....	3-42
	3.10.2 ASUS EZ Flash 2 utility.....	3-45
	3.10.3 ASUS CrashFree BIOS 3 utility.....	3-46
	3.10.4 ASUS BIOS Updater.....	3-47

Chapter 4: Software support

4.1	Installing an operating system.....	4-1
4.2	Support DVD information.....	4-1
	4.2.1 Running the support DVD.....	4-1
	4.2.2 Obtaining the software manuals.....	4-2
4.3	Software information.....	4-3
	4.3.1 AI Suite II.....	4-3
	4.3.2 ASUS TUF Thermal Radar.....	4-4
	4.3.3 TurboV EVO.....	4-9

Contents

4.3.4	DIGI+ Power Control	4-11
4.3.5	Sensor Recorder	4-15
4.3.6	Ai Charger+	4-16
4.3.7	USB Charger+	4-17
4.3.8	USB 3.0 Boost	4-19
4.3.9	Network iControl	4-20
4.3.10	ASUS Update	4-24
4.3.11	MyLogo2	4-25
4.3.12	Audio configurations	4-27
4.4	RAID configurations	4-28
4.4.1	RAID definitions	4-28
4.4.2	Installing Serial ATA hard disks	4-29
4.4.3	Setting the RAID item in BIOS	4-29
4.4.4	Intel® Rapid Storage Technology Option ROM utility	4-29
4.4.5	Intel® 2012 Desktop responsiveness technologies	4-33
4.5	Creating a RAID driver disk	4-45
4.5.1	Creating a RAID driver disk without entering the OS	4-45
4.5.2	Creating a RAID driver disk in Windows®	4-45
4.5.3	Installing the RAID driver during Windows® OS installation	4-46
4.5.4	Using a USB floppy disk drive	4-47
 Chapter 5: Multiple GPU technology support		
5.1	AMD® CrossFireX™ technology	5-1
5.1.1	Requirements	5-1
5.1.2	Before you begin	5-1
5.1.3	Installing two CrossFireX™ graphics cards	5-2
5.1.4	Installing the device drivers	5-3
5.1.5	Enabling the AMD® CrossFireX™ technology	5-3
5.2	NVIDIA® SLI™ technology	5-4
5.2.1	Requirements	5-4
5.2.2	Installing two SLI-ready graphics cards	5-4
5.2.3	Installing the device drivers	5-5
5.2.4	Enabling the NVIDIA® SLI™ technology	5-5
5.3	LucidLogix Virtu MVP	5-8
5.3.1	Installing LucidLogix Virtu MVP	5-8
5.3.2	Setting up your display	5-9
5.3.3	Configuring LucidLogix Virtu MVP	5-10
 Appendices		
	Notices	A-1

Safety information

Electrical safety

- To prevent electrical shock hazard, disconnect the power cable from the electrical outlet before relocating the system.
- When adding or removing devices to or from the system, ensure that the power cables for the devices are unplugged before the signal cables are connected. If possible, disconnect all power cables from the existing system before you add a device.
- Before connecting or removing signal cables from the motherboard, ensure that all power cables are unplugged.
- Seek professional assistance before using an adapter or extension cord. These devices could interrupt the grounding circuit.
- Ensure that your power supply is set to the correct voltage in your area. If you are not sure about the voltage of the electrical outlet you are using, contact your local power company.
- If the power supply is broken, do not try to fix it by yourself. Contact a qualified service technician or your retailer.

Operation safety

- Before installing the motherboard and adding devices on it, carefully read all the manuals that came with the package.
- Before using the product, ensure all cables are correctly connected and the power cables are not damaged. If you detect any damage, contact your dealer immediately.
- To avoid short circuits, keep paper clips, screws, and staples away from connectors, slots, sockets and circuitry.
- Avoid dust, humidity, and temperature extremes. Do not place the product in any area where it may become wet.
- Place the product on a stable surface.
- If you encounter technical problems with the product, contact a qualified service technician or your retailer.

About this guide

This user guide contains the information you need when installing and configuring the motherboard.

How this guide is organized

This guide contains the following parts:

- **Chapter 1: Product introduction**
This chapter describes the features of the motherboard and the new technology it supports.
- **Chapter 2: Hardware information**
This chapter lists the hardware setup procedures that you have to perform when installing system components. It includes description of the switches, jumpers, and connectors on the motherboard.
- **Chapter 3: BIOS setup**
This chapter tells how to change system settings through the BIOS Setup menus. Detailed descriptions of the BIOS parameters are also provided.
- **Chapter 4: Software support**
This chapter describes the contents of the support DVD that comes with the motherboard package and the software.
- **Chapter 5: Multiple GPU technology support**
This chapter describes how to install and configure multiple ATI® CrossFireX™, NVIDIA® SLI™ graphics cards, and LucidLogix Virtu MVP.

Where to find more information

Refer to the following sources for additional information and for product and software updates.

1. **ASUS websites**
The ASUS website provides updated information on ASUS hardware and software products. Refer to the ASUS contact information.
2. **Optional documentation**
Your product package may include optional documentation, such as warranty flyers, that may have been added by your dealer. These documents are not part of the standard package.

Conventions used in this guide

To ensure that you perform certain tasks properly, take note of the following symbols used throughout this manual.



DANGER/WARNING: Information to prevent injury to yourself when trying to complete a task.



CAUTION: Information to prevent damage to the components when trying to complete a task.



IMPORTANT: Instructions that you **MUST** follow to complete a task.



NOTE: Tips and additional information to help you complete a task.

Typography

Bold text

Indicates a menu or an item to select.

Italics

Used to emphasize a word or a phrase.

<Key>

Keys enclosed in the less-than and greater-than sign means that you must press the enclosed key.

Example: <Enter> means that you must press the Enter or Return key.

<Key1> + <Key2> + <Key3>

If you must press two or more keys simultaneously, the key names are linked with a plus sign (+).

Example: <Ctrl> + <Alt> +

SABERTOOTH Z77 specifications summary

CPU	<p>LGA 1155 socket for Intel® 3rd/2nd generation Core™ i7/i5/i3/Pentium®/Celeron® Processors Supports 22/32nm CPU Supports Intel® Turbo Boost Technology 2.0 * The Intel® Turbo Boost Technology 2.0 support depends on the CPU types ** Refer to www.asus.com for Intel CPU support list</p>
Chipset	Intel® Z77 Express Chipset
Memory	<p>4 x DIMM, Max. 32GB, DDR3 1866/1600/1333/1066 MHz, non-ECC, un-buffered memory Dual channel memory architecture Supports Intel® Extreme Memory Profile (XMP) * Hyper DIMM support is subject to the physical characteristics of the individual CPUs. Please refer to Memory QVL (Qualified Vendors) list for details. ** Refer to www.asus.com or this user manual for the Memory QVL (Qualified Vendors Lists)</p>
Expansion Slots	<p>2 x PCI Express 3.0*/2.0 x16 slots (single at x16, dual at x8/x8) 1 x PCI Express 2.0 x16 slot** [black] (Max. at x4 mode, compatible with PCIe x1 and x4 devices) 3 x PCI Express 2.0 x1 slots * PCIe 3.0 speed is supported by Intel® 3rd generation Core™ processors. ** The PCIe 2.0 x16 slot shares bandwidth with PCIe 2.0 x1_1 slot, PCIe 2.0 x1_2 slot, and PCIe 2.0 x1_3 slot. The PCIe 2.0 x16 slot default setting is in x1 mode.</p>
Multi-GPU Support	<p>Integrated Graphics Processor - Intel HD Graphics support Supports NVIDIA® Quad-GPU SLI™ Technology Supports AMD® Quad-GPU CrossFireX™ Technology Supports LucidLogix Virtu MVP Technology* * LucidLogix Virtu MVP supports Windows 7 operating systems.</p>
Storage	<p>Intel® Z77 Express Chipset</p> <ul style="list-style-type: none"> - 2 x SATA 6Gb/s ports (brown) with RAID 0, 1, 5, and 10 support - 4 x SATA 3Gb/s ports (black) with RAID 0, 1, 5, and 10 support - Supports Intel® Smart Response Technology, and Intel® Rapid Start Technology* <p>2 x ASMedia® 1061 SATA controllers**</p> <ul style="list-style-type: none"> - 2 x SATA 6Gb/s ports (gray) - 2 x eSATA 6Gb/s ports (red) <p>* Supports on Intel® Core processor family with Windows 7 operating systems. ** These SATA ports are for data hard drivers only. ATAPI devices are not supported.</p>
LAN	Intel® 82579V Gigabit LAN controller
Audio	<p>Realtek® ALC892 8-channel High Definition Audio CODEC</p> <ul style="list-style-type: none"> - Absolute Pitch 192khz/24bit True BD Lossless Sound - BD Audio Layer Content Protection - Supports Jack-Detection, Multi-Streaming, and Front Panel Jack-Retasking - Optical S/PDIF Out port at back I/O

(continued on the next page)

SABERTOOTH Z77 specifications summary

<p>USB</p>	<p>Intel® Z77 Express Chipset - supports ASUS USB 3.0 Boost UASP Mode*</p> <ul style="list-style-type: none"> - 4 x USB 3.0 ports (2 ports at mid-board, 2 ports at back panel) <p>ASMedia® 1042 USB 3.0 controllers - supports ASUS USB 3.0 Boost UASP Mode</p> <ul style="list-style-type: none"> - 2 x USB 3.0 ports at the back panel (blue) <p>Intel® Z77 Express Chipset</p> <ul style="list-style-type: none"> - 10 x USB 2.0/1.1 ports (6 ports at mid-board, 4 ports at back panel) <p>* USB 3.0 ports only support Windows® 7 or later versions. UASP standard only supports Windows® OS versions that are released after Windows® 7.</p>
<p>Exclusive TUF Features</p>	<p>“Ultimate COOL!” Thermal Solutions</p> <ul style="list-style-type: none"> - TUF Thermal Armor - TUF Thermal Radar <p>“TUF ENGINE!” Power Design</p> <ul style="list-style-type: none"> - 8+4+2 Digital Phase Power Design - TUF Components (Choke, Cap. & MOSFET; certified by military-standard) - ASUS DIGI+ Power Control Utility <p>“Safe & Stable!” Guardian Angel</p> <ul style="list-style-type: none"> - Dust Defender - ESD Guards - MemOK! - Anti Surge
<p>Other Special Features</p>	<p>USB 3.0 Boost featuring the latest USB 3.0 UASP standard</p> <p>USB BIOS Flashback with USB BIOS Flashback Wizard for EZ BIOS download scheduling</p> <p>USB Charger+ featuring quick-charging function for all devices</p> <p>Network iControl featuring instant network bandwidth domination for top network program in use</p> <p>LucidLogix Virtu MVP</p> <p>ASUS UEFI BIOS EZ Mode featuring friendly graphics user interface</p> <p>AI Suite II</p> <p>ASUS Q-Connector</p> <p>ASUS Q-Shield</p> <p>ASUS Q-LED (CPU, DRAM, VGA, Boot Device LED)</p> <p>ASUS Q-Slot</p> <p>ASUS Q-DIMM</p> <p>ASUS O.C. Profile</p> <p>ASUS CrashFree BIOS 3</p> <p>ASUS EZ Flash 2</p> <p>ASUS MyLogo 2™</p> <p>Multi-language BIOS</p>

(continued on the next page)

SABERTOOTH Z77 specifications summary

Back Panel I/O Ports	<ul style="list-style-type: none"> 1 x DisplayPort 1 x HDMI port 1 x Optical S/PDIF Output 1 x USB BIOS Flashback Button 2 x eSATA 6Gb/s ports 1 x LAN (RJ-45) port 4 x USB 3.0/2.0 ports (blue, 1 supports USB BIOS Flashback) 4 x USB 2.0/1.1 ports 8-channel Audio I/O ports
Internal I/O Connectors	<ul style="list-style-type: none"> 1 x USB 3.0/2.0 connector supports additional 2 USB 3.0/2.0 ports (19-pin; moss green) 3 x USB 2.0/1.1 connectors support additional 6 USB 2.0/1.1 ports 4 x SATA 6Gb/s connectors (2 x brown; 2 x gray) 4 x SATA 3Gb/s connectors (black) 1 x CPU Fan connector (4-pin black) 1 x CPU OPT fan connector (4-pin black) 4 x Chassis Fan connectors (4-pin black) 2 x Assistant Fan connectors (3-pin white) 1 x Front panel audio connector (AAFP) 1 x S/PDIF Out header 1 x 24-pin EATX Power connector 1 x 8-pin EATX 12V Power connector 1 x System Panel (Q-Connector) 1 x MemOK! button 1 x Clear CMOS jumper
BIOS Features	<p>64 Mb Flash ROM, UEFI AMI BIOS, PnP, DMI 2.0, WfM 2.0, SM BIOS 2.5, ACPI 2.0a, Multi-language BIOS, ASUS EZ Flash 2, ASUS CrashFree BIOS 3, F12 PrintScreen Function, F3 Shortcut Function, and ASUS DRAM SPD (Serial Presence Detect) memory information</p>
Manageability	<p>WfM 2.0, DMI 2.0, WOL by PME, PXE</p>
Support DVD	<ul style="list-style-type: none"> Drivers ASUS Utilities ASUS Update Anti-virus software (OEM version)
Form factor	<p>ATX form factor: 12 in. x 9.6 in. (30.5 cm x 24.4 cm)</p>

*Specifications are subject to change without notice.

Chapter 1

1.1 Welcome!











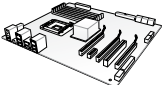

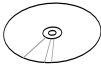
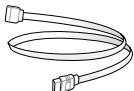
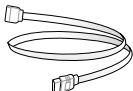

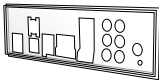
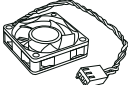
Thank you for buying an ASUS® SABERTOOTH Z77 motherboard!

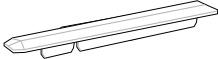
The motherboard delivers a host of new features and latest technologies, making it another standout in the long line of ASUS quality motherboards!

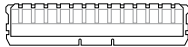
Before you start installing the motherboard, and hardware devices on it, check the items in your package with the list below.

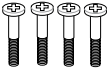
1.2 Package contents

Check your motherboard package for the following items.

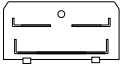
		
ASUS SABERTOOTH Z77 motherboard	User guide	Support DVD
		
2 x Serial ATA 6.0 Gb/s cables	2 x Serial ATA 3.0 Gb/s cables	1 x ASUS SLI™ bridge connector
		
1 x ASUS Q-Shield	2 x Accessory Fans	1 x 2-in-1 ASUS Q-Connector kit
		
3 x PCIe x16 Slot dust covers	3 x PCIe x1 Slot dust covers	2 x DRAM slot dust covers
		
2 x short fan screws	4 x long fan screws	1 x Adhesive sponge for 35mm fan
		
1 x TUF Five-year warranty manual (by region)	1 x TUF Certification card	40mm I/O Cover fan lid



- If any of the above items is damaged or missing, contact your retailer.
- The illustrated items above are for reference only. Actual product specifications may vary with different models.

1.3 Special features

1.3.1 Product highlights

LGA1155 socket for Intel® 3rd/2nd Generation Core™ i7 / Core™ i5 / Core™ i3 / Pentium® / Celeron® Processors

This motherboard supports the Intel® 3rd/2nd generation Core™ i7/i5/i3/Pentium®/Celeron® processors in the LGA1155 package, with iGPU, memory, and PCI Express controllers integrated to support onboard graphics out with dedicated chipsets, 2-channel (4 DIMMs) DDR3 memory, and 16 PCI Express 3.0/2.0 lanes. This provides great graphics performance. Intel® 3rd/2nd generation Core™ i7/i5/i3/Pentium®/Celeron® processors are among the most powerful and energy efficient CPUs in the world.

Intel® Z77 Express Chipset

The Intel® Z77 Express Chipset is a single-chipset designed to support the 1155 socket Intel® 3rd/2nd generation Core™ i7/i5/i3/Pentium®/Celeron® processors. It provides improved performance by utilizing serial point-to-point links, allowing increased bandwidth and stability. Additionally, Z77 chipset provides 4 USB 3.0 ports for 10 times faster data retrieval speed. Moreover, Intel® Z77 Express Chipset can also enable iGPU function, letting users enjoy the latest Intel® integrated graphic performance.

PCI Express® 3.0

PCI Express® 3.0 (PCIe 3.0) is the latest PCI Express bus standard with improved encoding schemes that provide twice the performance of the current PCIe 2.0. The total bandwidth for a x16 link reaches a maximum of 32Gb/s, double the 16Gb/s of PCIe 2.0 (in x16 mode). As such, PCIe 3.0 provides users an unprecedented data speeds, combined with the convenience and seamless transition offered by complete backward compatibility with PCIe 1.0 and PCIe 2.0 devices. PCIe 3.0 will become a must-have feature for users who wish to improve and optimize graphic performance, as well as have the latest technology available to them.

* PCI 3.0 speed is supported by Intel® 3rd generation Core™ processors.

Dual-Channel 1866 / 1600 / 1333 / 1066 MHz Support

The motherboard supports DDR3 memory that features data transfer rates of DDR3 1866 / 1600 / 1333 / 1066 MHz to meet the higher bandwidth requirements of the latest 3D graphics, multimedia, and Internet applications. The dual-channel DDR3 architecture enlarges the bandwidth of your system memory to boost system performance.

Quad-GPU SLI™ and Quad-GPU CrossFireX™ Support

Flexible Multi-GPU Solutions, Your Weapon of Choice!

SABERTOOTH Z77 brings you the multi-GPU choice of either SLI™ or CrossFireX. The motherboard features the most powerful Intel® Z77 platform to optimize PCIe allocation in multiple GPU configurations. Expect a brand-new gaming style you've never experienced before!

Intel® Smart Response Technology

SSD Speed with HDD Capacity

Intel® Smart Response Technology boosts overall system performance. It uses an installed fast SSD (min 18.6GB available capacity required) as a cache for frequently accessed data. Key benefits include reduced load and wait times, and lower power consumption through the elimination of unnecessary hard drive spin. This technology combines SSD performance with hard drive capacity, operating up to 4X faster than a hard drive-only system, and an important part of Green ASUS eco-friendly computing.

* Intel® Smart Response Technology is supported by 2nd/3rd generation Intel® Core™ processor family on Windows® 7™ operating systems.

** Operating systems must be installed on the HDD to launch Intel® Smart Response Technology. The capacity of the SSD is reserved for caching function.

Intel® Smart Connect Technology

Your computer could receive web updates with fresh content for selected applications even when setting the system to sleep. This means less time waiting for applications to start, update and sync with the Cloud, providing a more efficient way.

Intel® Rapid Start Technology

Allows your computer to quickly resume from a low-power hibernate state in seconds. Saving system memory to the designed SSD provides your computer a faster wake-up response time, while keeping the energy use low.

Complete USB 3.0 Integration

Double USB Access, Double Convenience

ASUS facilitates the strategic USB 3.0 accessibility for both the front and rear panel with 6 USB 3.0 ports in total. Experience the latest plug & play connectivity at speeds up to 10 times faster than USB 2.0. The SABERTOOTH Z77 affords greater convenience to high speed connectivity.

Extra SATA 6.0 Gb/s Support

Extra Ports, Extra Speed and Accessibility

The Intel® Z77 Express Chipset natively supports the next-generation Serial ATA (SATA) interface, delivering up to 6.0 Gb/s data transfer. ASUS provides extra SATA 6.0 Gb/s ports with enhanced scalability, faster data retrieval, and double the bandwidth of current bus systems.

1.3.2 “Ultimate COOL!” Thermal Solutions

TUF Thermal Armor

New generation Thermal Armor boosts cooling with dual turbo fans, enhancing the original TUF thermal design, and helping direct hot air away from components and the motherboard via smart shunt funneling. It covers the entire board with more powerful airflow, and uses special heat pipes to expedite thermal removal, and make sure temperatures stay low. The dedicated I/O cover fan draws additional cold air in, and expels even more heat for improved stability, plus new Thermal Armor comes with special convection holes in the PCB to facilitate underside flow. It now sports a military-themed style, perfect for case modders.

TUF Thermal Radar

The TUF Thermal Radar monitors temperatures in critical parts of the motherboard in real time, automatically adjusting fan speeds to make sure the system maintains high stability. It consists of multiple sensors, giving users the ability to track each individually. Automatic calculation of ideal fan speeds based on different parameters selected manually for components has everything cooler and longer-lasting. New Fan Overtime keeps the two turbo fans running a few minutes post shutdown on standby power to remove the remaining heat. Stopping high temperatures from lingering in the case where they can cause damage, it extends system longevity, dropping the heat by as much as 7°C in just ten minutes. To prolong fan lifespan, reduce noise, and lower power consumption, the new Fan Off has been added, automatically shutting off fans under either preset or manually-selected temperature thresholds.

1.3.3 “TUF ENGINE!” Power Design

New DIGI+ Power Control

New DIGI+ Power Control includes multiple digital voltage controllers, allowing extra precise modulation and tuning of CPU, iGPU, and DRAM. This innovative and industry-leading ASUS technology provides an extremely accurate voltage tuning for better efficiency, stability, and performance. With the next generation Intel VRD 12.5 future power design, CPU wattage can be decreased by half, creating a cooler and quieter PC. This innovation of industry-leading ASUS technology provides the smartest control for better power saving scenarios.

TUF Components (Choke, Cap. & MOSFET; certified by military-standard)

Get rugged performance even in the most challenging conditions with robust TUF chokes, solid capacitors, and MOSFETs – certified through third-party, military-grade testing. TUF Chokes, also known as the “Alloy Choke”, is made of a compound of various types of metal instead standard iron, enables the support of up to a massive 40A of rated current, 25% higher than conventional component. Furthermore, the single piece packaging also eliminates the emission of vibration noise, delivering superb characteristics as well as durability under extreme conditions.

1.3.4 “Safe & Stable!” Guardian Angel

Dust Defender

Dust particles and environmental contamination present a constant hazard to the optimal functioning of slots and connectors. Build up on contact points within slots compromises data transfer over time, negating the benefits of expensive and critical components such as graphics cards. Custom TUF design keeps this in mind with special shields that resist particulate entry, effectively extending slot and connector lifespan while promoting better performance.

MemOK!

MemOK! quickly ensures memory boot compatibility. This remarkable memory rescue tool requires a mere push of a button to patch memory issues. MemOK! determines fail-safe settings and dramatically improves your system boot success.

ESD Guards

ESD (Electrostatic Discharge) Guards provides protection against electrostatic discharges, which can damage the motherboard's components. The ASUS exclusive Anti-Static chip and circuit design, and the I/O shield provide four times better protection and ensure the motherboard's lifespan.

1.3.5 ASUS EZ DIY

ASUS UEFI BIOS (EZ Mode)

ASUS UEFI BIOS is a mouse-controlled user-friendly graphics interface that allows you to easily select performance settings, and drag and drop boot priorities with its EZ Mode interface. Its Advanced Mode interface allows you to configure more advanced BIOS settings.

ASUS Q-Design

DIY Quickly, DIY Easily!

ASUS Q-Slot and Q-DIMM design speed up, simplify, and enhances your DIY (Do-It-Yourself) experience.

ASUS Q-Shield

Easy and Comfortable Installations

The specially designed ASUS Q-Shield does without the usual "fingers" - making it convenient and easy to install. With better electric conductivity, it ideally protects your motherboard against static electricity and shields it against Electronic Magnetic Interference (EMI).

ASUS Q-Connector

Make Connection Quick and Accurate!

The ASUS Q-Connector allows you to connect or disconnect the chassis front panel cables in one easy step with one complete module. This unique adapter eliminates the trouble of plugging in one cable at a time, making the connection quick and accurate.

ASUS EZ-Flash 2

ASUS EZ Flash 2 is a user-friendly utility that allows you to update the BIOS without using a bootable floppy disk or an OS-based utility.

1.3.6 ASUS Exclusive Features

USB 3.0 Boost

ASUS USB 3.0 Boost technology supports UASP (USB Attached SCSI Protocol) and automatically increases a USB 3.0 device's transfer speed up to 170%.

USB Charger+

With a dedicated onboard controller, quick-charge your USB devices such as iProducts, smartphones, tablets, and other portable devices 50% faster, even when the PC is powered off, in sleep, or hibernation.

* **USB Charger+ only applies to the bottom port of USB3_12.**

USB BIOS Flashback

With USB BIOS Flashback, simply connect a USB flash drive containing the UEFI BIOS file to the USB 3.0 port, press the BIOS Flashback button for three seconds, and the BIOS is updated automatically. With its Windows-compatible application, you can regularly check for UEFI BIOS updates and download the latest UEFI BIOS automatically.

* **USB BIOS Flashback only applies to the bottom port of USB3_12.**

Network iControl

ASUS Network iControl is an intuitive one-stop network control center that makes it easier for you to manage your network bandwidth and allows you to set, monitor, and schedule the bandwidth priorities for your network programs. It also allows you to automatically connect to a PPPoE network for a more convenient online experience.

1.3.7 Other special features

LucidLogix Virtu MVP

LucidLogix Virtu MVP featuring HyperFormance™ Technology boosts your PCIe graphics card up to 30% beyond its original performance. Designed for Intel® processor graphics and Windows® 7 PCs, it perfectly combines the performance of discrete graphic cards with fast computing iGPU. Also, with newly designed Virtual Sync, users can enjoy a smoother gaming experience by eliminating tearing artifacts. LucidLogix Virtu MVP can also dynamically assign tasks to the best available graphics resource, based on power, performance, and system load. This allows users to fully utilize 3x faster video conversion with Intel® Quick Sync Video technology while retaining high-end 3D rendering and gaming performance, provided by both NVIDIA and AMD graphic cards. When the PCIe graphic cards are not required, the graphics control switches to the Intel® processor graphics, reducing the PCIe graphics power use down to zero, making the system more environment-friendly. For users searching for perfection, LucidLogix Virtu MVP provides great graphical performance, and best quality and efficiency.

* **LucidLogix Virtu MVP supports Windows® operating system.**

** **Intel® Quick Sync Video feature is supported by 3rd/2nd generation Intel® Core™ processor family**

DisplayPort 1.1a Support

DisplayPort is a digital display interface standard that delivers up to 10.8 Gbps of bandwidth over standard cables, providing billions of colors and bidirectional communications, thus enabling the fastest refresh rates, and the highest resolution digital display through a single cable. Also, it supports HDCP copy protection for Blu-ray discs. Simply output 3D signals through the connected DisplayPort 1.1a cable with your 3D display, then you can sit back and enjoy a perfect 3D animation experience.

HDMI 1.4a Support

High Definition Multimedia Surface (HDMI) is a set of digital video standards that delivers multi-channel audio and uncompressed digital video for full HD 1080p visuals through a single cable. Supporting HDCP copy protection such as HD DVD and blu-ray discs, HDMI provides you with the highest quality home theater experience.

ErP Ready

The motherboard is European Union's Energy-related Products (ErP) ready, and ErP requires products to meet certain energy efficiency requirement in regards to energy consumption. This is in line with ASUS vision of creating environment-friendly and energy-efficient products through product design and innovation to reduce carbon footprint of the product and thus mitigate environmental impacts.

2.1 Before you proceed

Take note of the following precautions before you install motherboard components or change any motherboard settings.



-
- Unplug the power cord from the wall socket before touching any component.
 - Before handling components, use a grounded wrist strap or touch a safely grounded object or a metal object, such as the power supply case, to avoid damaging them due to static electricity.
 - Hold components by the edges to avoid touching the ICs on them.
 - Whenever you uninstall any component, place it on a grounded antistatic pad or in the bag that came with the component.
 - Before you install or remove any component, ensure that the ATX power supply is switched off or the power cord is detached from the power supply. Failure to do so may cause severe damage to the motherboard, peripherals, or components.
-

2.2 Motherboard overview

2.2.1 Motherboard layout

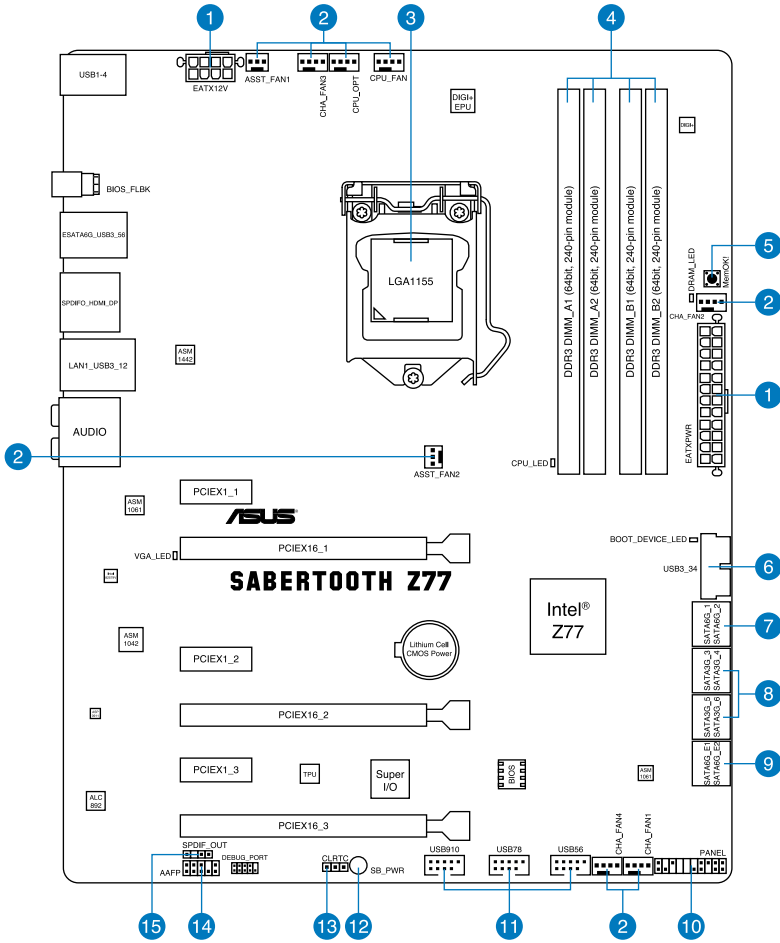

Refer to 2.2.8 Internal connectors and 2.3.11 Rear panel connection for more information about rear panel connectors and internal connectors.

Layout contents

Connectors/Jumpers/Slots		Page
1.	ATX power connectors (24-pin EATXPWR, 8-pin EATX12V)	2-24
2.	CPU, chassis, and assistant fan connectors (4-pin CPU_FAN, CHA_FAN1–4, CPU_OPT, 3-pin ASST_FAN)	2-22
3.	LGA1155 CPU socket	2-4
4.	DDR3 DIMM slots	2-5
5.	MemOK! switch	2-15
6.	USB 3.0 connector (20-1 pin USB3_34)	2-20
7.	Intel® Z77 Serial ATA 6Gb/s connectors (7-pin SATA6G_1/2 [brown])	2-17
8.	Intel® Z77 Serial ATA 3Gb/s connectors (7-pin SATA3G_3–6 [black])	2-18
9.	ASMedia® Serial ATA 6Gb/s connectors (7-pin SATA6G_E1/E2 [gray])	2-19
10.	System panel connector (20-8 pin PANEL)	2-25
11.	USB 2.0 connectors (10-1 pin USB56, USB78, USB910)	2-21
12.	Standby power LED (SB_PWR)	2-16
13.	Clear RTC RAM (3-pin CLRRTC)	2-14
14.	Front panel audio connector (10-1 pin AAFP)	2-23
15.	Digital audio connector (4-1 pin SPDIF_OUT)	2-21

2.2.2 Central Processing Unit (CPU)

The motherboard comes with a surface mount LGA1155 socket designed for the Intel® 3rd/2nd Generation Core™ i7 / Core™ i5 / Core™ i3 / Pentium / Celeron Processors.

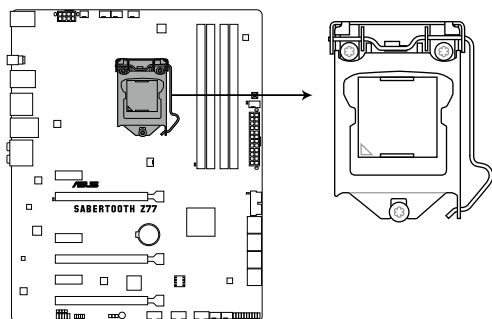

SABERTOOTH Z77 CPU LGA1155



Ensure that all power cables are unplugged before installing the CPU.



- The LGA1156 CPU is incompatible with the LGA1155 socket. DO NOT install a LGA1156 CPU on the LGA1155 socket.
 - Upon purchase of the motherboard, ensure that the PnP cap is on the socket and the socket contacts are not bent. Contact your retailer immediately if the PnP cap is missing, or if you see any damage to the PnP cap/socket contacts/motherboard components. ASUS will shoulder the cost of repair only if the damage is shipment/transit-related.
 - Keep the cap after installing the motherboard. ASUS will process Return Merchandise Authorization (RMA) requests only if the motherboard comes with the cap on the LGA1155 socket.
 - The product warranty does not cover damage to the socket contacts resulting from incorrect CPU installation/removal, or misplacement/loss/incorrect removal of the PnP cap.
-

2.2.3 System memory

The motherboard comes with four Double Data Rate 3 (DDR3) Dual Inline Memory Modules (DIMM) slots.



A DDR3 module is notched differently from a DDR or DDR2 module. DO NOT install a DDR or DDR2 memory module to the DDR3 slot.

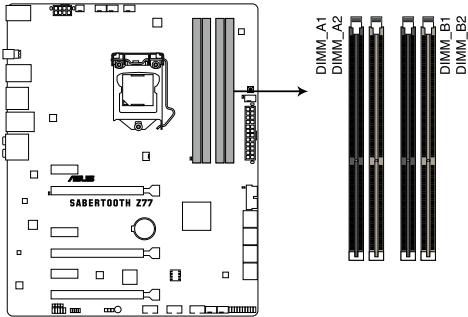

SABERTOOTH Z77 240-pin DDR3 DIMM socket

Recommended memory configurations

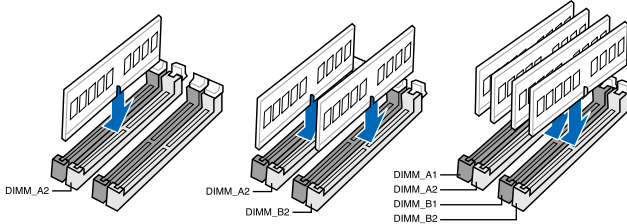

Memory configurations

You may install 1GB, 2GB, 4GB and 8GB unbuffered and non-ECC DDR3 DIMMs into the DIMM sockets.



- You may install varying memory sizes in Channel A, and Channel B. The system maps the total size of the lower-sized channel for the dual-channel configuration. Any excess memory from the higher-sized channel is then mapped for single-channel operation.
- According to Intel CPU spec, DIMM voltage below 1.65V is recommended to protect the CPU.
- Always install DIMMs with the same CAS latency. For optimum compatibility, we recommend that you obtain memory modules from the same vendor.
- Due to the memory address limitation on 32-bit Windows OS, when you install 4GB or more memory on the motherboard, the actual usable memory for the OS can be about 3GB or less. For effective use of memory, we recommend that you do any of the following:
 - Use a maximum of 3GB system memory if you are using a 32-bit Windows OS.
 - Install a 64-bit Windows OS when you want to install 4GB or more on the motherboard.For more details, refer to the Microsoft® support site at <http://support.microsoft.com/kb/929605/en-us>.
- This motherboard does not support DIMMs made up of 512Mb (64MB) chips or less (Memory chip capacity counts in Megabit, 8 Megabit/Mb = 1 Megabyte/MB).



- The default memory operation frequency is dependent on its Serial Presence Detect (SPD), which is the standard way of accessing information from a memory module. Under the default state, some memory modules for overclocking may operate at a lower frequency than the vendor-marked value. To operate at the vendor-marked or at a higher frequency, refer to section **3.4 Ai Tweaker menu** for manual memory frequency adjustment.
- For system stability, use a more efficient memory cooling system to support a full memory load (4 DIMMs) or overclocking condition.

SABERTOOTH Z77 Motherboard Qualified Vendors Lists (QVL)

DDR3 1333 MHz capability

Vendors	Part No.	Size	SS/DS	Chip Brand	Chip NO.	Timing	Voltage	DIMM socket support (Optional)		
								1 DIMM	2 DIMM	4 DIMM
A-DATA	AD6311B0823EV	2GB	SS	A-DATA	3CCA-1509A	-	-	*	*	*
A-DATA	AXDU11333GC2G9(XMP)	2GB	SS	-	-	9-9-9-24	-	*	*	*
A-DATA	AD631C1624EV	4GB	DS	A-DATA	3CCA-1509A	-	-	*	*	*
A-DATA	SU3U1333W8G9(XMP)	8GB	DS	ELPIDA	J4208BASE-DJ-F	-	-	*	*	*
Apacer	78.A1GC6.9L1	2GB	DS	Apacer	AM5D5808FEQSBG	9	-	*	*	*
Apacer	78.B1GDE.9L10C	4GB	DS	Apacer	AM5D5908CEHSBG	9	-	*	*	*
CORSAIR	TW3X4G1333C9A	4GB (2x2GB)	DS	-	-	9-9-9-24	1.5	*	*	*
CORSAIR	CMX8GX3M2A1333C9(XMP)	8GB (2x4GB)	DS	-	-	9-9-9-24	1.5	*	*	*
ELPIDA	EBJ20UF8BCF0-DJ-F	2GB	SS	Elpida	J2108BCSE-DJ-F	-	-	*	*	*
ELPIDA	EBJ41UF8BCF0-DJ-F	4GB	DS	ELPIDA	J2108BCSE-DJ-F	-	-	*	*	*
G.SKILL	F3-10600CL9D-4GBNT	4GB (2x2GB)	DS	G.SKILL	D3 128M8CE9 2GB	9-9-9-24	1.5	*	*	*
G.SKILL	F3-10666CL9D-8GBRL	8GB (2x4GB)	DS	-	-	9-9-9-24	1.5	*	*	*
G.SKILL	F3-10666CL9D-8GBXL	8GB (2x4GB)	DS	-	-	9-9-9-24	1.5	*	*	*
GEIL	GET316GB1333C9QC	16GB (4x4GB)	DS	-	-	9-9-9-24	1.5	*	*	*
GEIL	GG34GB1333C9DC	4GB (2x2GB)	DS	GEIL	GL1L128M88BA 115FW	9-9-9-24	1.3	*	*	*
GEIL	GG34GB1333C9DC	4GB (2x2GB)	DS	GEIL	GL1L128M88BA 15B	9-9-9-24	1.3	*	*	*
GEIL	GB34GB1333C7DC	4GB (2x2GB)	DS	GEIL	GL1L128M88BA15FW	7-7-7-24	1.5	*	*	*
GEIL	GVP38GB1333C9DC	8GB (2x4GB)	DS	-	-	9-9-9-24	1.5	*	*	*
Hynix	HMT325U6BFR8C-H9	2GB	SS	Hynix	H5TQ2G83BFR	-	-	*	*	*
Hynix	HMT125U6TFR8A-H9	2GB	DS	Hynix	H5TC1G83TFR	-	-	*	*	*
KINGMAX	FLFE85F-C8KL9	2GB	SS	KINGMAX	KFC8FNLXF-DXX-15A	-	-	*	*	*
KINGMAX	FLFE85F-C8KM9	2GB	SS	Kingmax	KFC8FNMXF-BXX-15A	-	-	*	*	*
KINGMAX	FLFE85F-B8KL9	2GB	DS	KINGMAX	KFB8FNLXL-BNF-15A	-	-	*	*	*
KINGMAX	FLFF65F-C8KL9	4GB	DS	KINGMAX	KFC8FNLXF-DXX-15A	-	-	*	*	*
KINGMAX	FLFF65F-C8KM9	4GB	DS	Kingmax	KFC8FNMXF-BXX-15A	-	-	*	*	*
KINGSTON	KVR1333D3S8N9/2G	2GB	SS	Micron	IFD77 D9LGK	-	1.5	*	*	*
KINGSTON	KVR1333D3N9/2G	2GB	DS	Kingston	D1288JPNPLD9U	9	1.5	*	*	*
KINGSTON	KHX1333C9D3UK2/4GX(XMP)	4GB (2x2GB)	DS	-	-	9	1.25	*	*	*
KINGSTON	KVR1333D3N9K2/4G	4GB (2x2GB)	DS	KINGSTON	D1288JEMFPGD9U	-	1.5	*	*	*
KINGSTON	KVR1333D3E9S/4G	4GB	DS	Elpida	J2108ECSE-DJ-F	9	1.5	*	*	*
MICRON	MT4JTF12864AZ-1G4D1	1GB	SS	Micron	D9LGQ	-	-	*	*	*
MICRON	MT8JTF25664AZ-1G4D1	2GB	SS	Micron	D9LGK	-	-	*	*	*
MICRON	MT8JTF25664AZ-1G4D1	2GB	SS	Micron	D9LGK	-	-	*	*	*
MICRON	MT8JTF25664AZ-1G4M1	2GB	SS	MICRON	D9PFJ	-	-	*	*	*
MICRON	MT16JTF51264AZ-1G4D1	4GB	DS	Micron	D9LGK	-	-	*	*	*
OCZ	OCZ3G1333LV4GK	4GB (2x2GB)	DS	-	-	9-9-9	1.65	*	*	*
OCZ	OCZ3G1333LV8GK	8GB (2x4GB)	DS	-	-	9-9-9	1.65	*	*	*
OCZ	OCZ3G1333LV8GK	8GB (2x4GB)	DS	-	-	9-9-9	1.65	*	*	*
OCZ	OCZ3RPR1333C9LV8GK	8GB (2x4GB)	DS	-	-	9-9-9	1.65	*	*	*
PSC	PC310600U-9-10-A0	1GB	SS	PSC	A3P1GF3FGF	-	-	*	*	*
PSC	PC310600U-9-10-B0	2GB	DS	PSC	A3P1GF3FGF	-	-	*	*	*
SAMSUNG	M378B5773DH0-CH9	2GB	SS	SAMSUNG	K4B2G08460	-	-	*	*	*

SABERTOOTH Z77 Motherboard Qualified Vendors Lists (QVL) DDR3 1333 MHz capability (continued)

Vendors	Part No.	Size	SS/ DS	Chip Brand	Chip NO.	Timing	Voltage	DIMM socket support (Optional)		
								1 DIMM	2 DIMM	4 DIMM
SAMSUNG	M378B5673FH0-CH9	2GB	DS	SAMSUNG	K4B1G0846F	-	-	-	-	-
SAMSUNG	M378B5273CH0-CH9	4GB	DS	SAMSUNG	K4B2G0846C	K4B2G0846C	-	-	-	-
SAMSUNG	M378B5273DH0-CH9	4GB	DS	SAMSUNG	K4B2G0846D	-	-	-	-	-
SAMSUNG	M378B1G73AH0-CH9	8GB	DS	SAMSUNG	K4B4G0846A-HCH9	-	-	-	-	-
Transcend	JM1333KLN-2G (582670)	2GB	SS	Micron	ICD77 C9L GK	-	-	-	-	-
Transcend	JM1333KLN-2G	2GB	SS	Transcend	TK483PCW3	-	-	-	-	-
Transcend	TS256MLK64V3N (585541)	2GB	SS	Micron	ICD77 D9L GK	9	-	-	-	-
Transcend	TS256MLK64V3N (566577)	2GB	SS	Hynix	H5TQ2G83BFR	9	-	-	-	-
Transcend	TS256MLK64V3N (574206)	2GB	SS	Micron	D9L GK	9	-	-	-	-
Transcend	JM1333KLN-4G (583782)	4GB	DS	Transcend	TK483PCW3	9	-	-	-	-
Transcend	JM1333KLN-4G	4GB	DS	Transcend	TK483PCW3	-	-	-	-	-
Transcend	TS512MLK64V3N (585538)	4GB	DS	Micron	IED27 D9L GK	9	-	-	-	-
Transcend	TS512MLK64V3N (574831)	4GB	DS	Micron	D9L GK	9	-	-	-	-
ACTICA	ACT1GHU64B8F1333S	1GB	SS	SAMSUNG	K4B1G0846F	-	-	-	-	-
ACTICA	ACT1GHU72C8G1333S	1GB	SS	SAMSUNG	K4B1G0846F(ECC)	-	-	-	-	-
ACTICA	ACT2GHU64B8G1333M	2GB	DS	Micron	D9KPT	-	-	-	-	-
ACTICA	ACT2GHU64B8G1333S	2GB	DS	SAMSUNG	K4B1G0846F	-	-	-	-	-
ACTICA	ACT2GHU72D8G1333M	2GB	DS	Micron	D9KPT(ECC)	-	-	-	-	-
ACTICA	ACT2GHU72D8G1333S	2GB	DS	SAMSUNG	K4B1G0846F(ECC)	-	-	-	-	-
ACTICA	ACT4GHU64B8H1333H	4GB	DS	Hynix	H5TQ2G83AFR	-	-	-	-	-
ACTICA	ACT4GHU72D8H1333H	4GB	DS	Hynix	H5TQ2G83AFR(ECC)	-	-	-	-	-
ATP	AQ56M72E8BJH9S	2GB	DS	SAMSUNG	K4B1G0846F(ECC)	-	-	-	-	-
ATP	AQ12M72E8BKH9S	4GB	DS	SAMSUNG	K4B2G0846C(ECC)	-	-	-	-	-
BUFFALO	D3U1333-1G	1GB	SS	Elpida	J1108BFBG-DJ-F	-	-	-	-	-
BUFFALO	D3U1333-2G	2GB	DS	Elpida	J1108BFBG-DJ-F	-	-	-	-	-
BUFFALO	D3U1333-4G	4GB	DS	NANYA	NT5CB256M8BN-CG	-	-	-	-	-
EK Memory	EKM324L28BP8-1H3	4GB (2x2GB)	DS	-	-	9	-	-	-	-
Elixir	M2F2G64CB88B7N-CG	2GB	SS	Elixir	N2CB2G808N-CG	-	-	-	-	-
Elixir	M2F2G64CB88D7N-CG	2GB	SS	Elixir	M2CB2G88BDN-CG	-	-	-	-	-
Elixir	M2F4G64CB88D5N-CG	4GB	DS	Elixir	M2CB2G88BDN-CG	-	-	-	-	-
GoodRam	GR1333D364L9/2G	2GB	DS	Qimonda	IDSH1G-03A1F1C-13H	-	-	-	-	-
KINGTIGER	F10DA2T1680	2GB	DS	KINGTIGER	KTG1333PS1208NST-C9	-	-	-	-	-
KINGTIGER	KTG2G1333PG3	2GB	DS	-	-	-	-	-	-	-
Patriot	PSD32G13332	2GB	DS	Patriot	PM128M8D3BU-15	9	-	-	-	-
Patriot	PGS34G1333LLKA	4GB (2x2GB)	DS	-	-	7-7-20	1.7	-	-	-
Patriot	PG38G1333EL(XMP)	8GB	DS	-	-	-	1.5	-	-	-
RiDATA	C304627CB1AG22Fe	2GB	DS	RiDATA	C304627CB1AG22Fe	9	-	-	-	-
RiDATA	E304459CB1AG32Cf	4GB	DS	RiDATA	E304459CB1AG32Cf	9	-	-	-	-
SanMax	SMD4G68H1P-13HZ	4GB	DS	Hynix	H5TQ2G83BFRH9C	-	1.5	-	-	-
Silicon Power	SP001GBLTE133S01	1GB	SS	NANYA	NT5CB128M8AN-CG	-	-	-	-	-
Silicon Power	SP001GBLTU133S02	1GB	SS	S-POWER	10Y73E5	9	-	-	-	-
Silicon Power	SP002GBLTE133S01	2GB	DS	NANYA	NT5CB128M8AN-CG	-	-	-	-	-
Team	TXD31024M1333C7 (XMP)	1GB	SS	Team	T3D1288LT-13	7-7-7-21	1.75	-	-	-
Team	TXD31048M1333C7-D (XMP)	1GB	SS	Team	T3D1288LT-13	7-7-7-21	1.75	-	-	-
Team	TXD32048M1333C7-D (XMP)	2GB	DS	Team	T3D1288LT-13	7-7-7-21	1.5-1.6	-	-	-

SABERTOOTH Z77 Motherboard Qualified Vendors Lists (QVL)

DDR3 1600 MHz capability

Vendors	Part No.	Size	SS/DS	Chip Brand	Chip NO.	Timing	Voltage	DIMM socket support (Optional)		
								1 DIMM	2 DIMM	4 DIMM
A-DATA	AM2U16BC2P1	2GB	SS	A-DATA	3CCD-1509A	-	-	*	*	*
A-DATA	AM2U16BC4P2	4GB	DS	A-DATA	3CCD-1509A	-	-	*	*	*
A-DATA	AX3U1600CC4G9(XMP)	4GB	DS	-	-	-	1.55~1.75	*	*	*
A-DATA	AX3U1600PC4G8(XMP)	4GB	DS	-	-	8-8-8-24	1.55~1.75	*	*	*
CORSAIR	HX3X12G1600C9(XMP)	12GB (6x2GB)	DS	-	-	9-9-9-24	1.6	*	*	*
CORSAIR	CMZ16GX3M4A1600C9(XMP)	16GB (4x4GB)	DS	-	-	9-9-9-24	1.5	*	*	*
CORSAIR	CMG4GX3M2A1600C6	4GB (2x2GB)	DS	-	-	6-6-6-18	1.65	*	*	*
CORSAIR	CMP6GX3M3A1600C8(XMP)	6GB (3x2GB)	DS	-	-	8-8-8-24	1.65	*	*	*
CORSAIR	CMP6GX3M3A1600C8(XMP)	6GB (3x2GB)	DS	-	-	8-8-8-24	1.65	*	*	*
CORSAIR	CMX6GX3M3C1600C7(XMP)	6GB (3x2GB)	DS	-	-	7-8-7-20	1.65	*	*	*
CORSAIR	CMZ8GX3M2A1600C8(XMP)	8GB (2x4GB)	DS	-	-	8-8-8-24	1.5	*	*	*
CORSAIR	CMZ8GX3M2A1600C9(XMP)	8GB (2x4GB)	DS	-	-	9-9-9-24	1.5	*	*	*
Crucial	BL12864BN1608.8FF(XMP)	2GB (2x1GB)	SS	-	-	8-8-8-24	1.65	*	*	*
G.SKILL	F3-12800CL7Q-16GBXH(XMP)	16GB (4x4GB)	DS	-	-	7-8-7-24	1.6	*	*	*
G.SKILL	F3-12800CL9Q-16GBXL(XMP)	16GB (4x4GB)	DS	-	-	9-9-9-24	1.5	*	*	*
G.SKILL	F3-12800CL7D-8GBRH(XMP)	8GB (2x4GB)	DS	-	-	7-8-7-24	1.6	*	*	*
G.SKILL	F3-12800CL9D-8GBRL(XMP)	8GB (2x4GB)	DS	-	-	9-9-9-24	1.5	*	*	*
G.SKILL	F3-12800CL9D-8GBSR2(XMP)	8GB (2x4GB)	DS	-	-	9-9-9-24	1.25	*	*	*
G.SKILL	F3-12800CL8D-8GBECO(XMP)	8GB (2x4GB)	DS	-	-	8-8-8-24	1.35	*	*	*
GEIL	GET316GB1600C9QC(XMP)	16GB (4x4GB)	DS	-	-	9-9-9-28	1.6	*	*	*
KINGSTON	KHX1600C9D3K3/12GX(XMP)	12GB (3x4GB)	DS	-	-	9	1.65	*	*	*
KINGSTON	KHX1600C9D3T1BK3/12GX(XMP)	12GB (3x4GB)	DS	-	-	9	1.65	*	*	*
KINGSTON	KHX1600C9D3K3/12GX(XMP)	12GB(3x4GB)	DS	-	-	-	1.65	*	*	*
KINGSTON	KHX1600C9D3K6/24GX(XMP)	24GB (6x4GB)	DS	-	-	9	1.65	*	*	*
KINGSTON	KHX1600C8D3K2/4GX(XMP)	4GB (2x2GB)	DS	-	-	8	1.65	*	*	*
KINGSTON	KHX1600C9D3K2/4GX(XMP)	4GB (2x2GB)	DS	-	-	-	1.65	*	*	*
KINGSTON	KHX1600C9D3LK2/4GX(XMP)	4GB (2x2GB)	DS	-	-	-	1.65	*	*	*
KINGSTON	KHX1600C9D3X2K2/4GX(XMP)	4GB (2x2GB)	DS	-	-	9	1.65	*	*	*
KINGSTON	KHX1600C9D3K3/6GX(XMP)	6GB (3x2GB)	DS	-	-	9	1.65	*	*	*
KINGSTON	KHX1600C9D3K3/6GX(XMP)	6GB (3x2GB)	DS	-	-	9	1.65	*	*	*
KINGSTON	KHX1600C9D3T1K3/6GX(XMP)	6GB (3x2GB)	DS	-	-	-	1.65	*	*	*
KINGSTON	KHX1600C9D3T1K3/6GX(XMP)	6GB (3x2GB)	DS	-	-	9	1.65	*	*	*
OCZ	OCZ3BE1600C8LV4GK	4GB(2x2GB)	DS	-	-	8-8-8	1.65	*	*	*
Transcend	JM1600KLN-8GK	8GB (2x4GB)	DS	Transcend	TK483PCW3	-	-	*	*	*
Asint	SLZ3128M8-EGJ1D(XMP)	2GB	DS	Asint	3128M8-GJ1D	-	-	*	*	*
EK Memory	EKM324L28BP8-116(XMP)	4GB (2x2GB)	DS	-	-	9	-	*	*	*
EK Memory	EKM324L28BP8-116(XMP)	4GB (2 x 2GB)	DS	-	-	9	-	*	*	*
GoodRam	GR1600D364L9/2G	2GB	DS	GoodRam	GF1008KC-JN	-	-	*	*	*
KINGTIGER	KTG2G1600PG3(XMP)	2GB	DS	-	-	-	-	*	*	*
Mushkin	996805(XMP)	4GB (2x2GB)	DS	-	-	6-8-6-24	1.65	*	*	*
Patriot	PX7312G1600LLK(XMP)	12GB (3x4GB)	DS	-	-	8-9-8-24	1.65	*	*	*
Patriot	PGS34G1600LLK2	4GB (2x2GB)	DS	-	-	8-8-8-24	1.7	*	*	*
Patriot	PGS34G1600LLKA	4GB (2x2GB)	DS	-	-	7-7-7-20	1.7	*	*	*
Patriot	PVV38G1600LLK(XMP)	8GB (2x4GB)	DS	-	-	8-9-8-24	1.65	*	*	*
Patriot	PX538G1600LLK(XMP)	8GB (2x4GB)	DS	-	-	8-9-8-24	1.65	*	*	*
SanMax	SMD-4G68HP-16KZ	4GB	DS	Hynix	H5TQ2G83BFRPBC	-	1.5	*	*	*
Team	TXD31024M1600C8-D(XMP)	1GB	SS	Team	T3D1288RT-16	8-8-8-24	1.65	*	*	*
Team	TXD32048M1600HC8-D(XMP)	2GB	DS	Team	T3D1288RT-16	8-8-8-24	1.65	*	*	*

SABERTOOTH Z77 Motherboard Qualified Vendors Lists (QVL) DDR3 1800 MHz capability

Vendors	Part No.	Size	SS/ DS	Chip Brand	Chip NO.	Timing	Voltage	DIMM socket support (Optional)		
								1 DIMM	2 DIMM	4 DIMM
G.SKILL	F3-14400CL9D-4GBRL(XMP)	4GB (2x2GB)	DS	-	-	9-9-9-24	1.60	*	*	*

SABERTOOTH Z77 Motherboard Qualified Vendors Lists (QVL) DDR3 1866 MHz capability

Vendors	Part No.	Size	SS/ DS	Chip Brand	Chip NO.	Timing	Voltage	DIMM socket support (Optional)		
								1 DIMM	2 DIMM	4 DIMM
A-DATA	AX3U1866GC2G9B(XMP)	2GB	SS	-	-	9-11-9-27	1.55-1.75	*	*	*
A-DATA	AX3U1866GC4G9B(XMP)	4GB	DS	-	-	9-11-9-27	1.55-1.75	*	*	*
CORSAIR	CMT3GX3M4X1866C9(XMP)	32GB (4x8GB)	DS	-	-	9-10-9-27	1.5	*	*	*
CORSAIR	CM28GX3M2A1866C9(XMP)	8GB (2x4GB)	DS	-	-	9-10-9-27	1.5	*	*	*
G.SKILL	F3-14900CL9Q-16GBXL(XMP)	16GB (4x4GB)	DS	-	-	9-10-9-28	1.5	*	*	*
G.SKILL	F3-14900CL9D-8GBSR(XMP)	8GB (2x4GB)	DS	-	-	9-10-9-28	1.5	*	*	*
G.SKILL	F3-14900CL9Q-8GBFLD(XMP)	8GB (2x4GB)	DS	-	-	9-9-9-24	1.6	*	*	*
Patriot	PXD32G1866ELK(XMP)	4GB (2x2GB)	SS	-	-	9-9-9-24	1.65	*	*	*
Patriot	F3-14400CL9D-4GBRL(XMP)	4GB (2x2GB)	DS	-	-	9-11-9-27	1.65	*	*	*

SABERTOOTH Z77 Motherboard Qualified Vendors Lists (QVL) DDR3 2000 MHz capability

Vendors	Part No.	Size	SS/ DS	Chip Brand	Chip NO.	Timing	Voltage	DIMM socket support (Optional)		
								1 DIMM	2 DIMM	4 DIMM
A-DATA	AX3U2000GC4G9B(XMP)	4GB	DS	-	-	9-11-9-27	1.55-1.75	*	*	*
Apacer	78.AAGD5.9KD(XMP)	6GB (3x2GB)	DS	-	-	9-9-9-27	-	*	*	*
CORSAIR	CMT6GX3M3A2000C8(XMP)	6GB (3x2GB)	DS	-	-	8-9-8-24	1.65	*	*	*
G.SKILL	F3-16000CL9D-4GBRH(XMP)	4GB (2x2GB)	DS	-	-	9-9-9-24	1.65	*	*	*
G.SKILL	F3-16000CL9D-4GBTD(XMP)	4GB (2x2GB)	DS	-	-	9-9-9-24	1.65	*	*	*
GEIL	GUP34GB2000C9DC(XMP)	4GB (2x2GB)	DS	-	-	9-9-9-28	1.65	*	*	*
KINGSTON	KHX2000C9AD3T1K3/6GX(XMP)	6GB (3x2GB)	DS	-	-	9	1.65	*	*	*
Transcend	TX2000KLN-8GK (388375)(XMP)	4GB	DS	-	-	-	1.6	*	*	*
AEXEA	AXA3ES4GK2000LG28V(XMP)	4GB (2x2GB)	DS	-	-	-	1.65	*	*	*
Patriot	PX7312G2000ELK(XMP)	12GB (3x4GB)	DS	-	-	9-11-9-27	1.65	*	*	*
Patriot	PV736G2000ELK(XMP)	6GB (3x2GB)	DS	-	-	7-7-7-20	1.65	*	*	*
Silicon Power	SP002GBLYU200S02(XMP)	2GB	DS	-	-	-	-	*	*	*
Team	TXD32048M2000C9(XMP)	2GB	DS	Team	T3D1288RT-20	9-9-9-24	1.5	*	*	*
Team	TXD32048M2000C9-L(XMP)	2GB	DS	Team	T3D1288RT-20	9-9-9-24	1.6	*	*	*

SABERTOOTH Z77 Motherboard Qualified Vendors Lists (QVL) DDR3 2133 MHz capability

Vendors	Part No.	Size	SS/ DS	Chip Brand	Chip NO.	Timing	Voltage	DIMM socket support (Optional)		
								1 DIMM	2 DIMM	4 DIMM
A-DATA	AX3U2133C2G9B(XMP)	2GB	SS	-	-	9-11-9-27	1.55-1.75	*	*	
A-DATA	AX3U2133G2G9B(XMP)	2GB	SS	-	-	9-9-9-24	1.55-1.75	*	*	
Apacer	78.BAGE4.AFD0C(XMP)	8GB (2x 4GB)	DS	-	-	9-9-9-24	-	*	*	*
CORSAIR	CMT4GX3M2A2133C9(XMP)	4GB (2x 2GB)	DS	-	-	9-10-9-24	1.65	*	*	*
CORSAIR	CMT4GX3M2B2133C9(Ver7.1)(XMP)	4GB (2x 2GB)	DS	-	-	9-9-9-24	1.5	*	*	*
CORSAIR	CMT4GX3M2B2133C9(XMP)	4GB (2x 2GB)	DS	-	-	9-10-9-27	1.5	*	*	*
G.SKILL	F3-17000CL9Q-16GBXLD(XMP)	16GB (4x 4GB)	DS	-	-	9-11-9-28	1.65	*	*	*
G.Skill	F3-17000CL9Q-16GBZH(XMP)	16GB (4x 4GB)	DS	-	-	9-11-10-28	1.65	*	*	*
G.SKILL	F3-17066CL9Q-16GBTDD(XMP)	16GB (4x 4GB)	DS	-	-	9-9-9-24	1.65	*	*	*
G.SKILL	F3-17066CL9D-8GBPID(XMP)	8GB (2x 4GB)	DS	-	-	9-9-9-24	1.65	*	*	*
KINGSTON	KHX2133C9AD3T1K2/4GX(XMP)	4GB (2x 2GB)	DS	-	-	-	1.65	*	*	*
KINGSTON	KHX2133C9AD3T1K2/4GX(XMP)	4GB (2x 2GB)	DS	-	-	9	1.65	*	*	*
KINGSTON	KHX2133C9AD3W1K2/4GX(XMP)	4GB (2x 2GB)	DS	-	-	9	1.65	*	*	*
KINGSTON	KHX2133C9AD3X2K2/4GX(XMP)	4GB (2x 2GB)	DS	-	-	9	1.65	*	*	*
KINGSTON	KHX2133C9AD3X2K2/4GX(XMP)	4GB (2x 2GB)	DS	-	-	9-9-9-24	1.65	*	*	*
KINGSTON	KHX2133C9AD3T1FK4/8GX(XMP)	8GB (4x 2GB)	DS	-	-	9	1.65	*	*	*
OCZ	OC23XTEP2133C9LV4GK	2GB	DS	-	-	7-7-7-20	1.65	*	*	*
Patriot	PVV34G2133C9K(XMP)	4GB (2x 2GB)	DS	-	-	9-11-9-27	1.66	*	*	*

SABERTOOTH Z77 Motherboard Qualified Vendors Lists (QVL) DDR3 2200 MHz capability

Vendors	Part No.	Size	SS/ DS	Chip Brand	Chip NO.	Timing	Voltage	DIMM socket support (Optional)		
								1 DIMM	2 DIMM	4 DIMM
G.SKILL	F3-17600CL7D-4GBFLS(XMP)	4G (2x2GB)	DS	-	-	7-10-10-28	1.65	*	*	
GEIL	GET34GB2200C9DC(XMP)	4GB (2x2GB)	DS	-	-	9-10-9-28	1.65	*	*	*
GEIL	GET38GB2200C9ADC(XMP)	8GB (2x4GB)	DS	-	-	9-11-9-28	1.65	*	*	*
KINGMAX	FLKE85F-B8KJAA-FEIS(XMP)	4GB (2x2GB)	DS	Kingmax	N/A	-	-	*	*	*

SABERTOOTH Z77 Motherboard Qualified Vendors Lists (QVL) DDR3 2400 MHz capability

Vendors	Part No.	Size	SS/ DS	Chip Brand	Chip NO.	Timing	Voltage	DIMM socket support (Optional)		
								1 DIMM	2 DIMM	4 DIMM
CORSAIR	CMGTX8(XMP)	8GB (4x2GB)	SS	-	-	10-12-10-30	1.65	*	*	
CORSAIR	CMGTX8(XMP)	8GB (4x2GB)	DS	-	-	10-12-10-30	1.65	*	*	
G.SKILL	F3-19200CL9D-4GBPIS(XMP)	4G (2x2GB)	DS	-	-	9-11-9-28	1.65	*	*	*
Transcend	TX2400KLU-4GK (381850)(XMP)	2GB	DS	-	-	-	1.65	*	*	*

2.2.4 Expansion slots



Ensure to unplug the power cord before adding or removing expansion cards. Failure to do so may cause you physical injury and damage motherboard components.

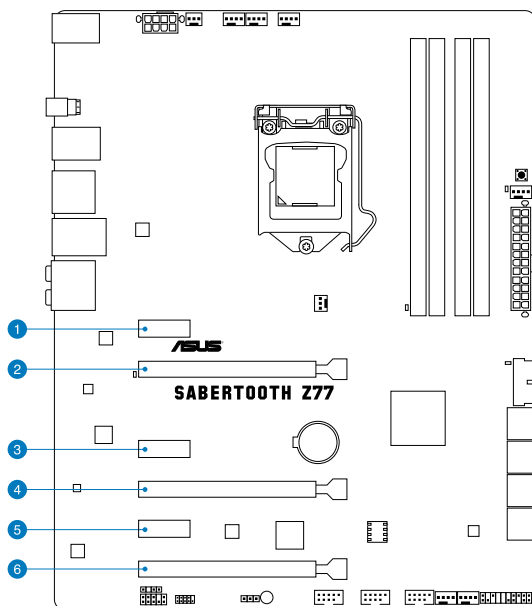

Slot No.	Slot Description
1	PCIe 2.0 x1_1 slot
2	PCIe 3.0 x16_1 slot (single at x16 or dual at x8/x8 mode)
3	PCIe 2.0 x1_2 slot
4	PCIe 3.0 x16_2 slot
5	PCIe 2.0 x1_3 slot
6	PCIe 2.0 x16_3 slot (max. at x4 mode)

VGA configuration	PCI Express operating mode		
	PCIe x16_1	PCIe x16_2	PCIe x16_3
Single VGA/PCIe card	x16 (Recommend for single VGA)	N/A	N/A
Dual VGA/PCIe card	x8	x8	N/A



- In single VGA card mode, use the PCIe 3.0 x16_1 slot (beige) for a PCI Express x16 graphics card to get better performance.
- In CrossFireX™ or SLI™ mode, use the PCIe 3.0 x16_1 and PCIe 3.0 x16_2 slots for PCI Express x16 graphics cards to get better performance.
- We recommend that you provide sufficient power when running CrossFireX™ or SLI™ mode. Refer to page 2-24 for details.
- Connect a chassis fan to the motherboard connector labeled CHA_FAN1/2 when using multiple graphics cards for better thermal environment. See page 2-22 for details.

PCIe x16_3 configuration

PCIe x16_3 Configuration	PCI Express sharing mode			
	PCIe x16_3	PCIe x1_1	PCIe x1_2	PCIe x1_3
x1 mode	x1	x1	x1	x1
x4 mode*	x4	N/A	N/A	N/A



Refer to **3.5.6 Onboard Devices Configuration** for details.

IRQ assignments for this motherboard

	A	B	C	D	E	F	G	H
PCIEX16_1	shared	-	-	-	-	-	-	-
PCIEX16_2	shared	-	-	-	-	-	-	-
PCIEX16_3	-	shared	-	-	-	-	-	-
PCIEX1_1	-	shared	-	-	-	-	-	-
PCIEX1_2	-	-	shared	-	-	-	-	-
PCIEX1_3	-	-	-	shared	-	-	-	-
Intel SATA	-	-	-	shared	-	-	-	-
USB 2.0 #0	-	-	-	-	-	-	-	shared
USB 2.0 #1	shared	-	-	-	-	-	-	-
USB 3.0	shared	-	-	-	-	-	-	-
HD Audio	-	-	-	-	-	-	shared	-
Intel LAN	-	-	-	-	shared	-	-	-
ASM USB 3.0	shared	-	-	-	-	-	-	-
ASM1061 #0	-	-	shared	-	-	-	-	-
ASM1061 #1	-	-	-	shared	-	-	-	-

2.2.5 Jumper

Clear RTC RAM (3-pin CLRTC)

This jumper allows you to clear the Real Time Clock (RTC) RAM in CMOS. You can clear the CMOS memory of date, time, and system setup parameters by erasing the CMOS RTC RAM data. The onboard button cell battery powers the RAM data in CMOS, which include system setup information such as system passwords.

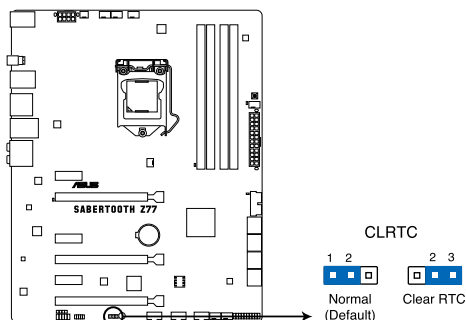

SABERTOOTH Z77 Clear RTC RAM

To erase the RTC RAM

1. Turn OFF the computer and unplug the power cord.
2. Move the jumper cap from pins 1-2 (default) to pins 2-3. Keep the cap on pins 2-3 for about 5–10 seconds, then move the cap back to pins 1-2.
3. Plug the power cord and turn ON the computer.
4. Hold down the key during the boot process and enter BIOS setup to re-enter data.



Except when clearing the RTC RAM, never remove the cap on CLRTC jumper default position. Removing the cap will cause system boot failure!



- If the steps above do not help, remove the onboard battery and move the jumper again to clear the CMOS RTC RAM data. After the CMOS clearance, reinstall the battery.
- You do not need to clear the RTC when the system hangs due to overclocking. For system failure due to overclocking, use the C.P.R. (CPU Parameter Recall) feature. Shut down and reboot the system so the BIOS can automatically reset parameter settings to default values.
- Due to the chipset behavior, AC power off is required to enable C.P.R. function. You must turn off and on the power supply or unplug and plug the power cord before rebooting the system.

2.2.6 Onboard switch

The onboard switch allows you to fine-tune performance when working on a bare or open-case system. This is ideal for overclockers and gamers who continually change settings to enhance system performance.

MemOK! switch

Installing DIMMs that are incompatible with the motherboard may cause system boot failure, and the DRAM_LED near the MemOK! switch lights continuously. Press and hold the MemOK! switch until the DRAM_LED starts blinking to begin automatic memory compatibility tuning for successful boot.

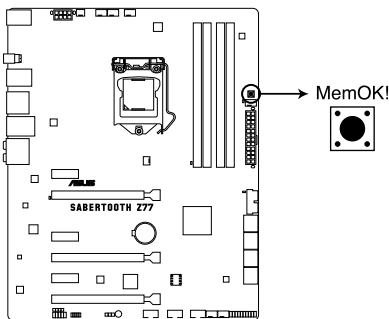

SABERTOOTH Z77 MemOK! switch



- Refer to section **2.2.7 Onboard LEDs** for the exact location of the DRAM_LED.
- The DRAM_LED also lights when the DIMM is not properly installed. Turn off the system and reinstall the DIMM before using the MemOK! function.
- The MemOK! switch does not function under Windows™ OS environment.
- During the tuning process, the system loads and tests failsafe memory settings. It takes about 30 seconds for the system to test one set of failsafe settings. If the test fails, the system reboots and test the next set of failsafe settings. The blinking speed of the DRAM_LED increases, indicating different test processes.
- Due to memory tuning requirement, the system automatically reboots when each timing set is tested. If the installed DIMMs still fail to boot after the whole tuning process, the DRAM_LED lights continuously. Replace the DIMMs with ones recommended in the Memory QVL (Qualified Vendors Lists) in this user manual or on the ASUS website at www.asus.com.
- If you turn off the computer and replace DIMMs during the tuning process, the system continues memory tuning after turning on the computer. To stop memory tuning, turn off the computer and unplug the power cord for about 5–10 seconds.
- If your system fail to boot due to BIOS overclocking, press the MemOK! switch to boot and load BIOS default settings. A message will appear during POST reminding you that the BIOS has been restored to its default settings.
- We recommend that you download and update to the latest BIOS version from the ASUS website at www.asus.com after using the MemOK! function.

2.2.7 Onboard LEDs

1. Standby Power LED

The motherboard comes with a standby power LED. The green LED lights up to indicate that the system is ON, in sleep mode, or in soft-off mode. This is a reminder that you should shut down the system and unplug the power cable before removing or plugging in any motherboard component. The illustration below shows the location of the onboard LED.

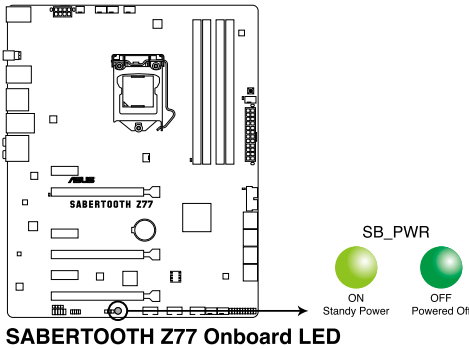

2. POST State LEDs

The POST State LEDs of CPU, DRAM, VGA card, and HDD indicate key components status during POST (Power-on Self Test). If an error is found, the LED next to the error device will continue lighting until the problem is solved. This user-friendly design provides an intuitional way to locate the root problem within a second.

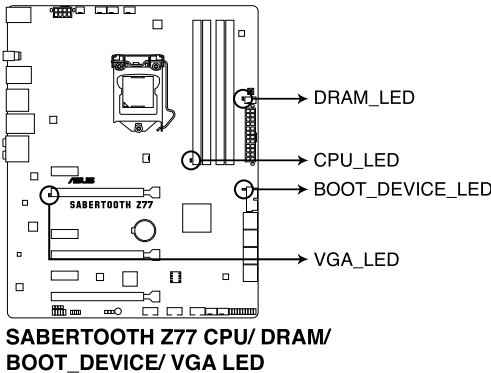

2.2.8 Internal connectors

1. Intel® Z77 Serial ATA 6Gb/s connectors (7-pin SATA6G_1/2 [brown])

These connectors connect to Serial ATA 6Gb/s hard disk drives via Serial ATA 6Gb/s signal cables.

If you installed Serial ATA hard disk drives, you can create a RAID 0, 1, 5, and 10 configuration with the Intel® Rapid Storage Technology through the onboard Intel® Z77 chipset.

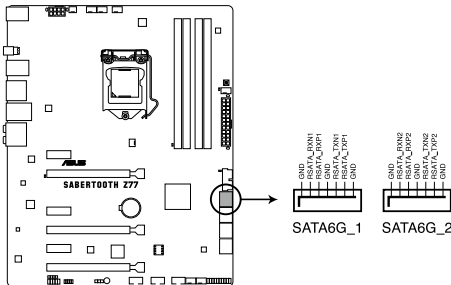

SABERTOOTH Z77 Intel® SATA 6.0 Gb/s connectors

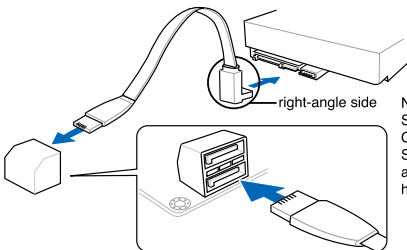

NOTE: Connect the right-angle side of SATA signal cable to SATA device.
Or you may connect the right-angle side of SATA cable to the onboard SATA port to avoid mechanical conflict with huge graphics cards.



- These connectors are set to [AHCI Mode] by default. If you intend to create a Serial ATA RAID set using these connectors, set the **SATA Mode** item in the BIOS to [RAID Mode]. Refer to section **3.5.3 SATA Configuration** for details.
- Before creating a RAID set, refer to section **4.4 RAID configurations** or the manual bundled in the motherboard support DVD.
- When using hot-plug and NCQ, set the **SATA Mode** in the BIOS to [AHCI Mode]. Refer to section **3.5.3 SATA Configuration** for details.
- You must install Windows® XP Service Pack 3 or later versions before using Serial ATA hard disk drives. The Serial ATA RAID feature is available only if you are using Windows® XP Service Pack 3 or later versions.

2. Intel® Z77 Serial ATA 3Gb/s connectors (7-pin SATA3G_3–6 [black])

These connectors connect to Serial ATA 3Gb/s hard disk drives and optical disc drives via Serial ATA 3Gb/s signal cables.

If you installed Serial ATA hard disk drives, you can create a RAID 0, 1, 5, and 10 configuration with the Intel® Rapid Storage Technology through the onboard Intel® Z77 chipset.

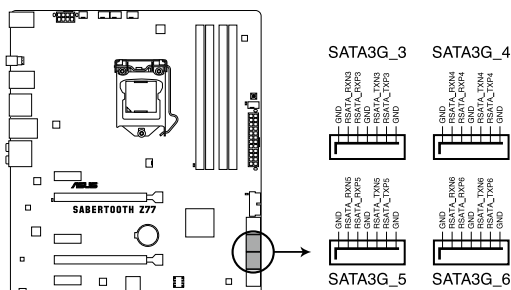

SABERTOOTH Z77 Intel® SATA 3.0 Gb/s connectors



- These connectors are set to [AHCI Mode] by default. If you intend to create a Serial ATA RAID set using these connectors, set the **SATA Mode** item in the BIOS to [RAID Mode]. Refer to section 3.5.3 **SATA Configuration** for details.
- Before creating a RAID set, refer to section 4.4 **RAID configurations** or the manual bundled in the motherboard support DVD.
- When using hot-plug and NCC, set the **SATA Mode** in the BIOS to [AHCI Mode]. Refer to section 3.5.3 **SATA Configuration** for details.
- You must install Windows® XP Service Pack 3 or later versions before using Serial ATA hard disk drives. The Serial ATA RAID feature is available only if you are using Windows® XP Service Pack 3 or later versions.

3. ASMedia® Serial ATA 6Gb/s connectors (7-pin SATA6G_E1/E2 [gray])

These connectors connect to Serial ATA 6Gb/s hard disk drives via Serial ATA 6Gb/s signal cables.

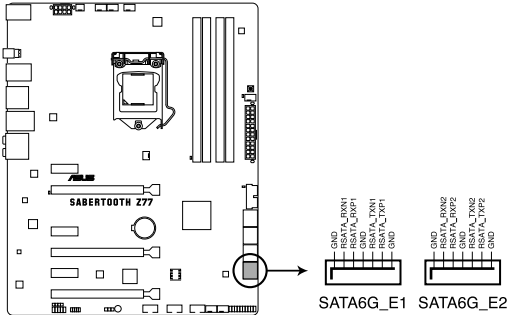

SABERTOOTH Z77 ASMedia® SATA 6.0 Gb/s connectors



- The SATA6G_E1/E2 (gray) connectors do not support ATAPI devices.
- You must install Windows® XP Service Pack 3 or later versions before using Serial ATA hard disk drives.
- For regular usage, the SATA6G_E1/E2 connectors are recommended for data drives.
- When using hot-plug and NCQ, set the **ASMedia Storage Controller** item in the BIOS to [Enabled]. Refer to section 3.5.5 **Onboard Devices Configuration** for details.

5. USB 3.0 connector (20-1 pin USB3_34)

This connector is for the additional USB 3.0 ports, and complies with the USB 3.0 specification that supports up to 4.8 Gbps connection speed. If the USB 3.0 front panel cable is available from your system chassis, with this USB 3.0 connector, you can have a front panel USB 3.0 solution.

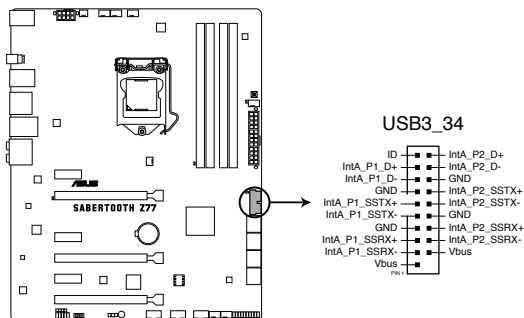

SABERTOOTH Z77 USB3.0 connector



The USB 3.0 module is purchased separately.

6. USB 2.0 connectors (10-1 pin USB78, USB56, USB910)

These connectors are for USB 2.0 ports. Connect the USB module cable to any of these connectors, then install the module to a slot opening at the back of the system chassis. These USB connectors comply with USB 2.0 specification that supports up to 480 Mbps connection speed.

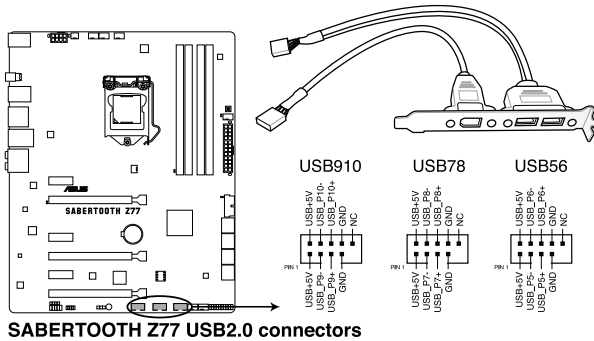

Never connect a 1394 cable to the USB connectors. Doing so will damage the motherboard!



- You can connect the front panel USB cable to the ASUS Q-Connector (USB, blue) first, and then install the Q-Connector (USB) to the USB connector onboard if your chassis supports front panel USB ports.
- Remove the USB dust cover before installation.
- The USB 2.0 connector module is purchased separately.

7. Digital audio connector (4-1 pin SPDIF_OUT)

This connector is for an additional Sony/Philips Digital Interface (S/PDIF) port(s). Connect the S/PDIF Out module cable to this connector, then install the module to a slot opening at the back of the system chassis.

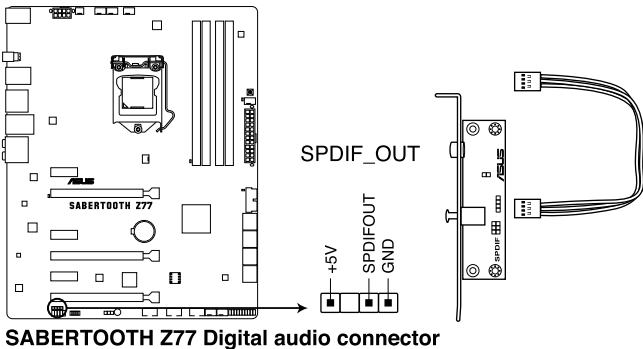

The S/PDIF module is purchased separately.

8. CPU, chassis, and assistant fan connectors (4-pin CPU_FAN; 4-pin CPU_OPT FAN; 4-pin CHA_FAN1-4; 3-pin ASST_FAN)

Connect the fan cables to the fan connectors on the motherboard, ensuring that the black wire of each cable matches the ground pin of the connector.

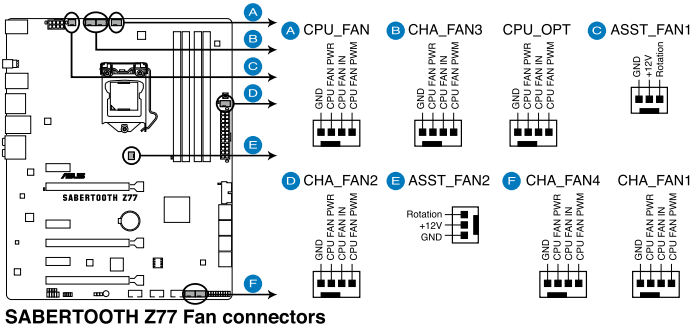

Do not forget to connect the fan cables to the fan connectors. Insufficient air flow inside the system may damage the motherboard components. These are not jumpers! Do not place jumper caps on the fan connectors!



- The CPU_FAN connector supports the CPU fan of maximum 1A (12 W) fan power.
- If you install two VGA cards, we recommend that you plug the rear chassis fan cable to the motherboard connector labeled CHA_FAN1 or CHA_FAN2 for better thermal environment.

9. Front panel audio connector (10-1 pin AAFP)

This connector is for a chassis-mounted front panel audio I/O module that supports either HD Audio or legacy AC'97 audio standard. Connect one end of the front panel audio I/O module cable to this connector.

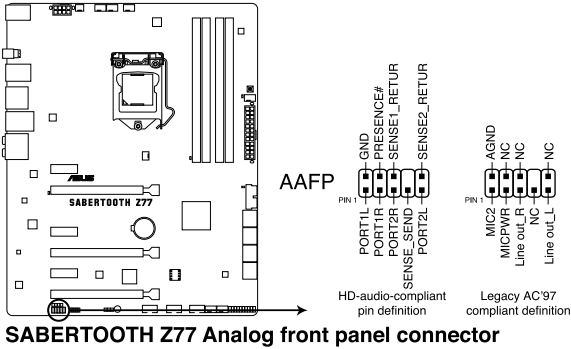

SABERTOOTH Z77 Analog front panel connector



- We recommend that you connect a high-definition front panel audio module to this connector to avail of the motherboard's high-definition audio capability.
- If you want to connect a high-definition front panel audio module to this connector, set the **Front Panel Type** item in the BIOS setup to **[HD]**; if you want to connect an AC'97 front panel audio module to this connector, set the item to **[AC'97]**. By default, this connector is set to **[HD]**.

10. ATX power connectors (24-pin EATXPWR; 8-pin EATX12V)

These connectors are for ATX power supply plugs. The power supply plugs are designed to fit these connectors in only one orientation. Find the proper orientation and push down firmly until the connectors completely fit.

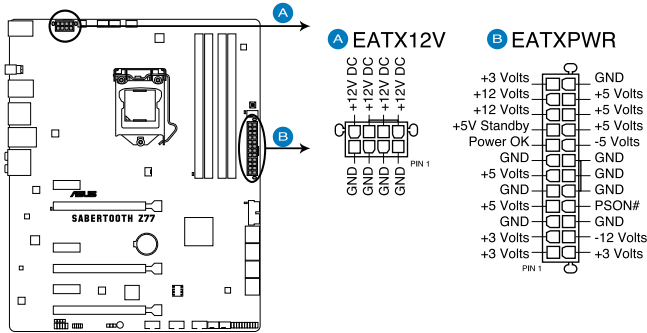

SABERTOOTH Z77 ATX power connectors



- For a fully configured system, we recommend that you use a power supply unit (PSU) that complies with ATX 12 V Specification 2.0 (or later version) and provides a minimum power of 350W.
- Do not forget to connect the 4-pin/8-pin EATX12 V power plug; otherwise, the system will not boot.
- Use of a PSU with a higher power output is recommended when configuring a system with more power-consuming devices. The system may become unstable or may not boot up if the power is inadequate.
- If you want to use two or more high-end PCI Express x16 cards, use a PSU with 1000W power or above to ensure the system stability.
- If you are uncertain about the minimum power supply requirement for your system, refer to the Recommended Power Supply Wattage Calculator at <http://support.asus.com/PowerSupplyCalculator/PSCalculator.aspx?SLanguage=en-us> for details.

11. System panel connector (20-8 pin PANEL)

This connector supports several chassis-mounted functions.

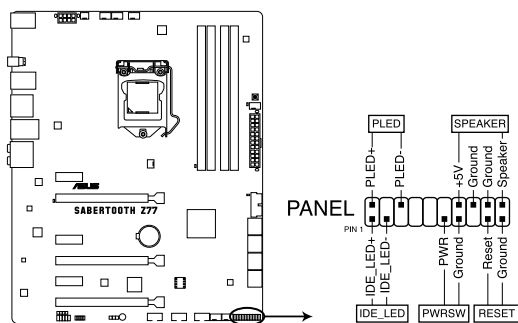

SABERTOOTH Z77 System panel connector

- **System power LED (2-pin PLED)**

This 2-pin connector is for the system power LED. Connect the chassis power LED cable to this connector. The system power LED lights up when you turn on the system power, and blinks when the system is in sleep mode.

- **Hard disk drive activity LED (2-pin IDE_LED)**

This 2-pin connector is for the HDD Activity LED. Connect the HDD Activity LED cable to this connector. The IDE LED lights up or flashes when data is read from or written to the HDD.

- **System warning speaker (4-pin SPEAKER)**

This 4-pin connector is for the chassis-mounted system warning speaker. The speaker allows you to hear system beeps and warnings.

- **ATX power button/soft-off button (2-pin PWRSW)**





This connector is for the system power button. Pressing the power button turns the system on or puts the system in sleep or soft-off mode depending on the BIOS settings. Pressing the power switch for more than four seconds while the system is ON turns the system OFF.

- **Reset button (2-pin RESET)**

This 2-pin connector is for the chassis-mounted reset button for system reboot without turning off the system power.

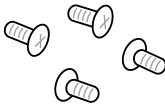
2.3 Building your computer system

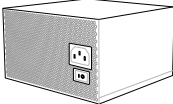
2.3.1 Additional tools and components to build a PC system

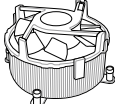
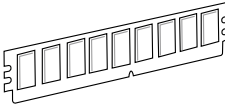
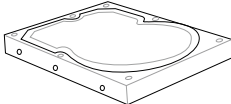
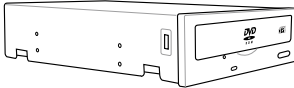
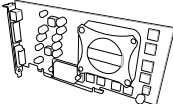
	
1 bag of screws	Philips (cross) screwdriver
	
PC chassis	Power supply unit
	
Intel LGA 1155 CPU	Intel LGA 1155 compatible CPU Fan
	
DIMM	SATA hard disk drive
	
SATA optical disc drive (optional)	Graphics card (optional)



The tools and components in the table above are not included in the motherboard package.

2.3.2 CPU installation



Please note the order in opening/ closing the double latch. Follow the instructions printed on the metal sealing hatch or the illustrations shown below in this manual. The plastic cap will pop up automatically once the CPU is in place and the hatch properly sealed down.

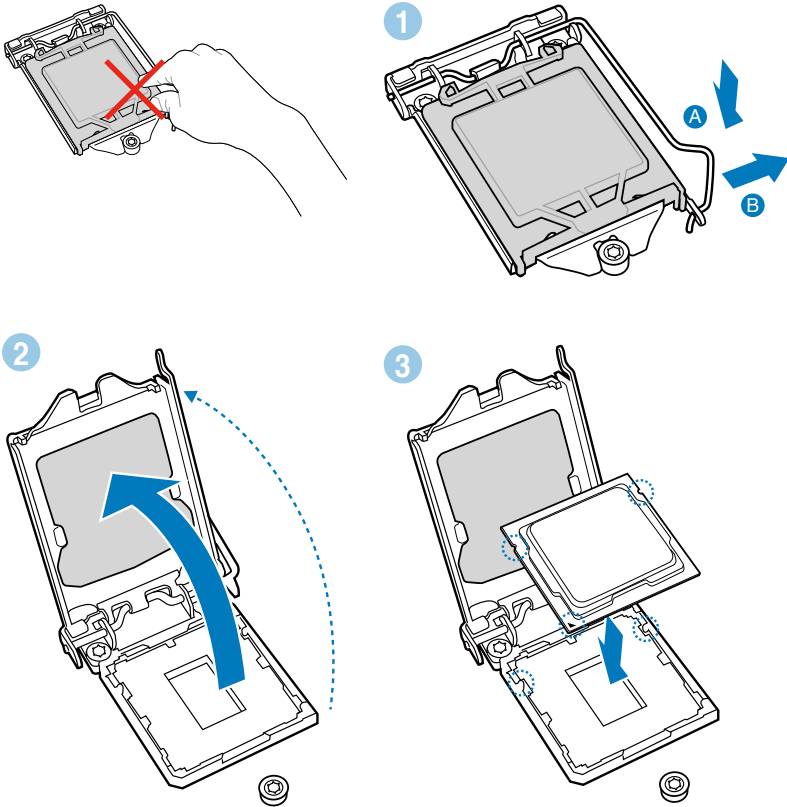

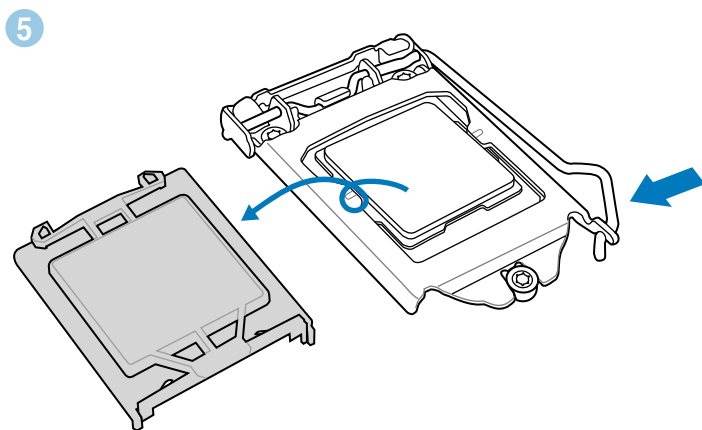
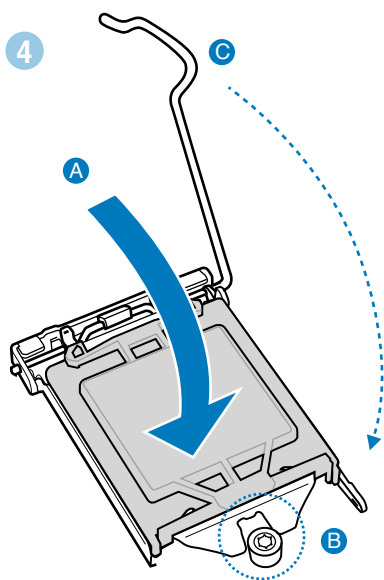

2.3.3 CPU heatsink and fan assembly installation

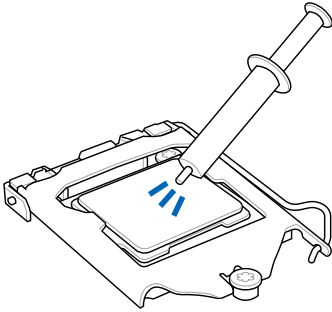

Apply the Thermal Interface Material to the CPU heatsink and CPU before you install the heatsink and fan if necessary.

To install the CPU heatsink and fan assembly

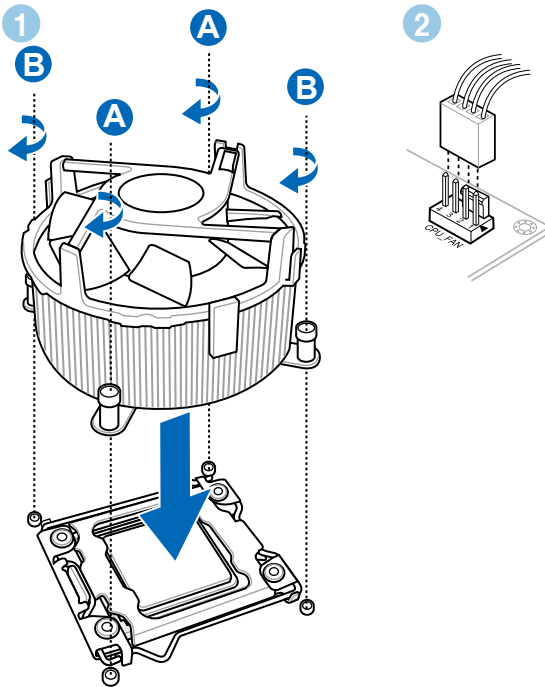

2.3.4 DIMM installation

1

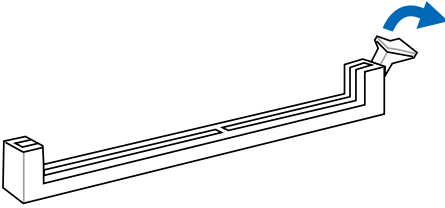

2

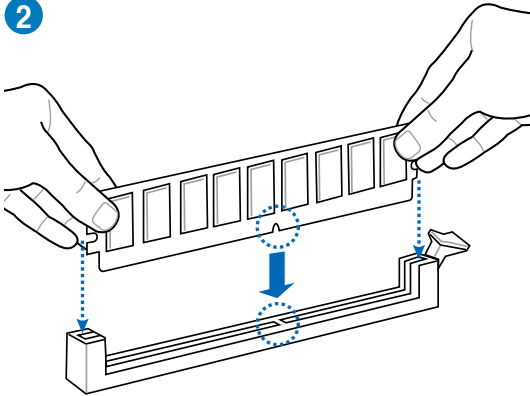

3

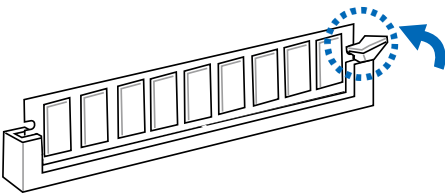

To remove a DIMM

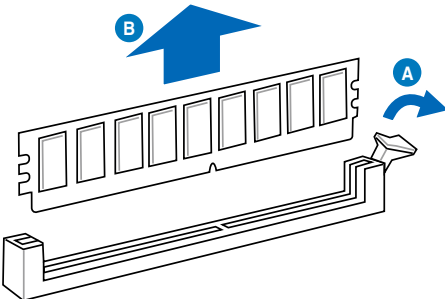

2.3.5 Motherboard installation



The diagrams in this section are for reference only. The motherboard layout may vary with models, but the installation steps remain the same.

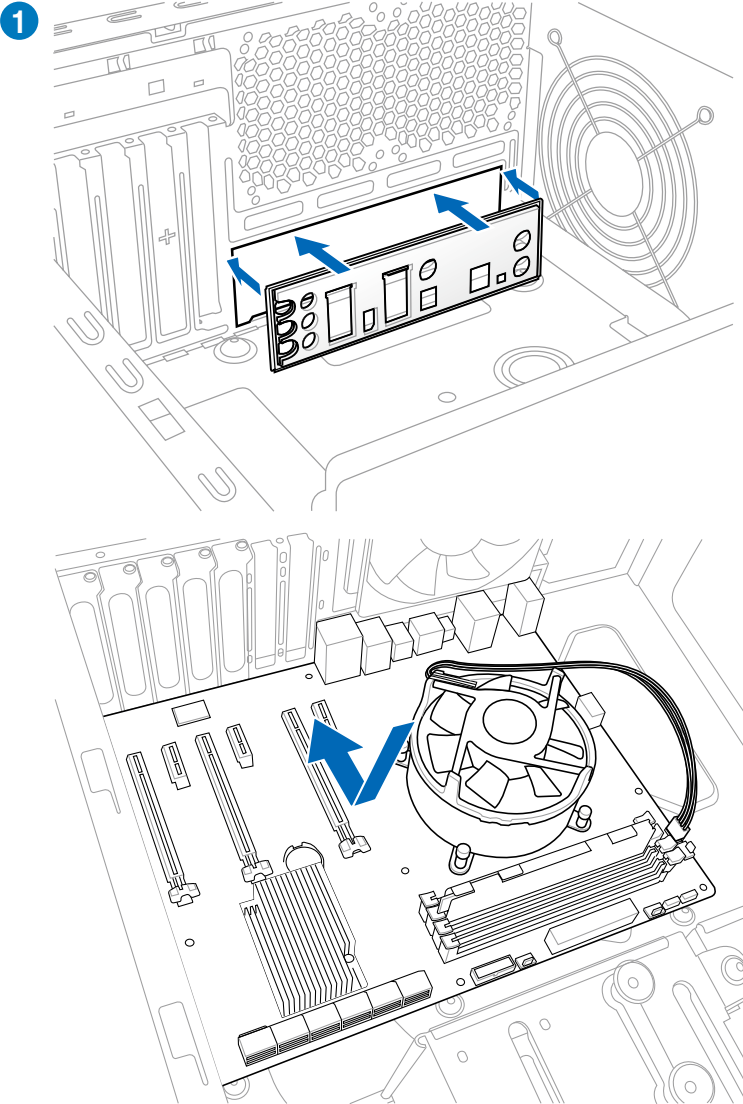

3

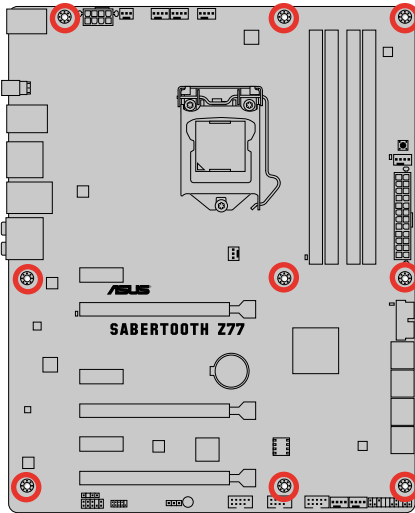
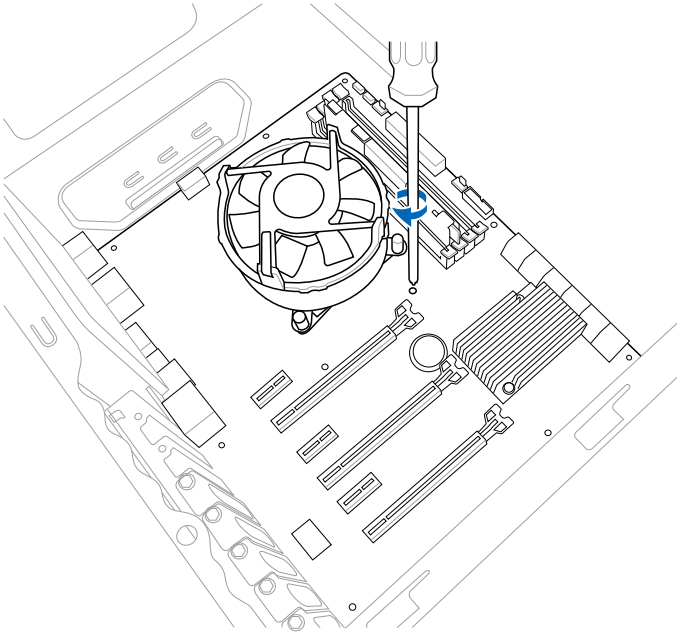

DO NOT overtighten the screws! Doing so can damage the motherboard.

2.3.6 Thermal Armor for ASUS SABERTOOTH Z77

The Thermal Armor for ASUS SABERTOOTH Z77 consists of a rear I/O cover fan, and a cover fan assembly, providing effective dissipation of the heat generated from the motherboard components. To ensure the most optimum heat dissipation, follow the instruction below to install the I/O cover fan to the rear I/O cover.

Installing the first accessory fan:

1. Remove the screw on the rear I/O cover, and then remove the lid to show the fan socket.

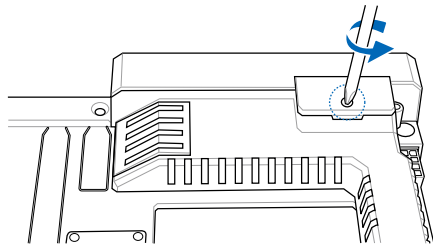

2. Secure the accessory fan to the designated fan slot of the I/O fan cover lid using the two bundled short screws. The fan cable must be on the bottom right corner opposite to the installed I/O cover fan lid, and the back of the fan faces the screw hole of the I/O fan cover lid.

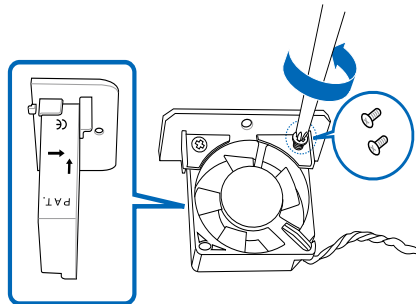

- Use the bundled 40mm I/O cover fan lid if you want to install a 40mm fan.
- The arrow markings pointing in one direction determine the fan's back part and the direction of the airflow.

3. Remove the release paper, and stick the adhesive sponge on the opposite side of the installed I/O fan cover.

- The sponge acts as a filler between the PC board and the fan.
- The sponge is not needed if you choose to install the 40mm fan.

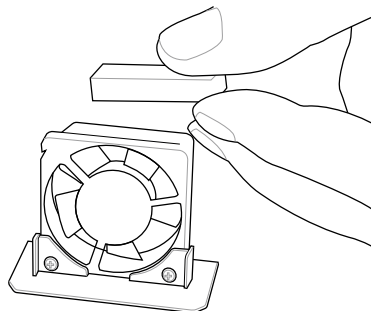

4. Install the assembled fan and sponge to the rear I/O fan socket, and screw the I/O fan cover lid to close.



The TUF logo must be visible along with the I/O ports.

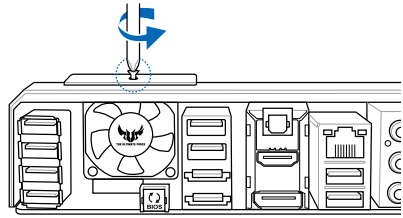

5. Place the fan cable inside the cable slot, and connect the fan cable to the assistant fan (ASST_FAN1) connector on the motherboard.



Keep the fan cable hidden under the thermal armor to prevent clutter.

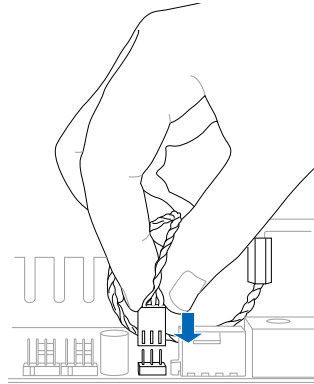

Installing the second accessory fan:

1. Remove the fan cover lid to show the fan socket and the fan connector.

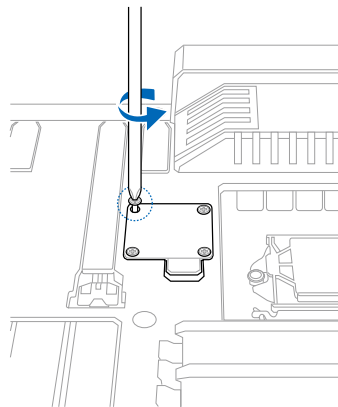

2. Place the fan into the socket, ensuring that the TUF logo is facing up, and screw to lock in place using the four bundled long screws.



Keep the fan cable hidden under the thermal armor to prevent clutter.

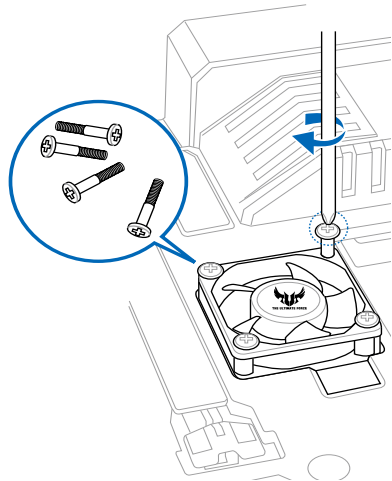

3. Connect the fan cable to the assistant fan (ASST_FAN2) connector on the motherboard.



The screwdriver is not included in the package.

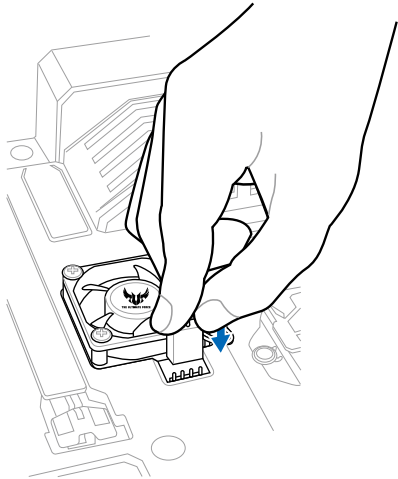

2.3.7 ATX Power connection

1

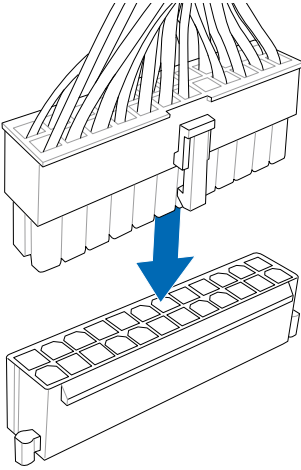

2

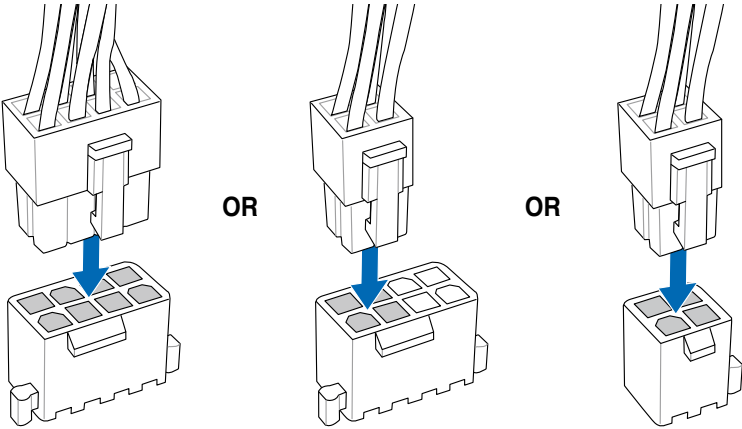

2.3.8 SATA device connection

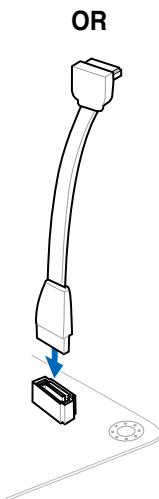
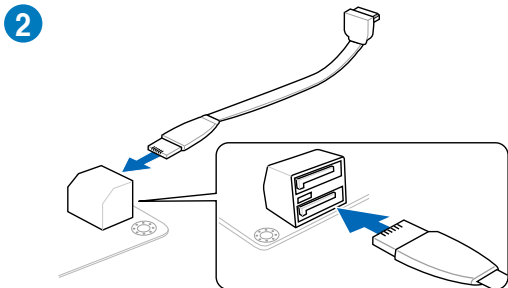
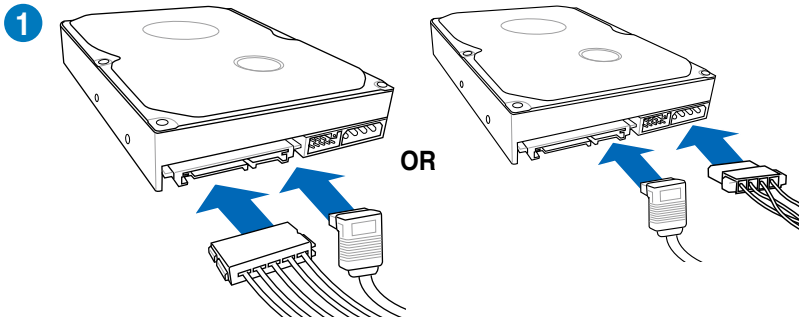

2.3.9 Front I/O Connector

To install ASUS Q-Connector

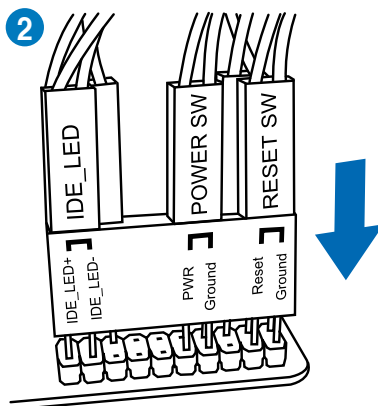
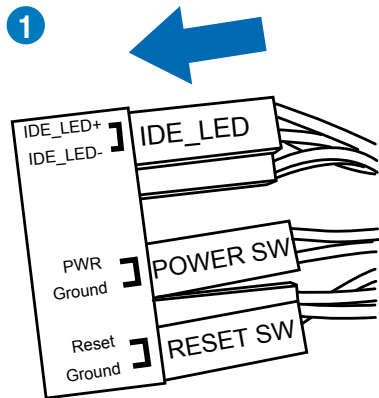

To install USB 2.0 Connector

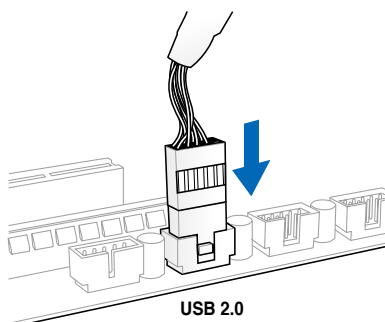

Remove the USB dust cover before installing the USB 2.0 connector.

To install front panel audio connector

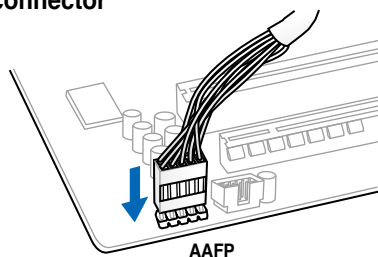

To install USB 3.0 Connector

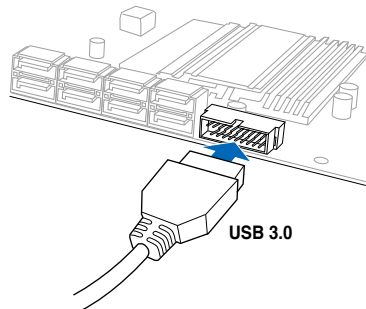

2.3.10 Rear panel connection

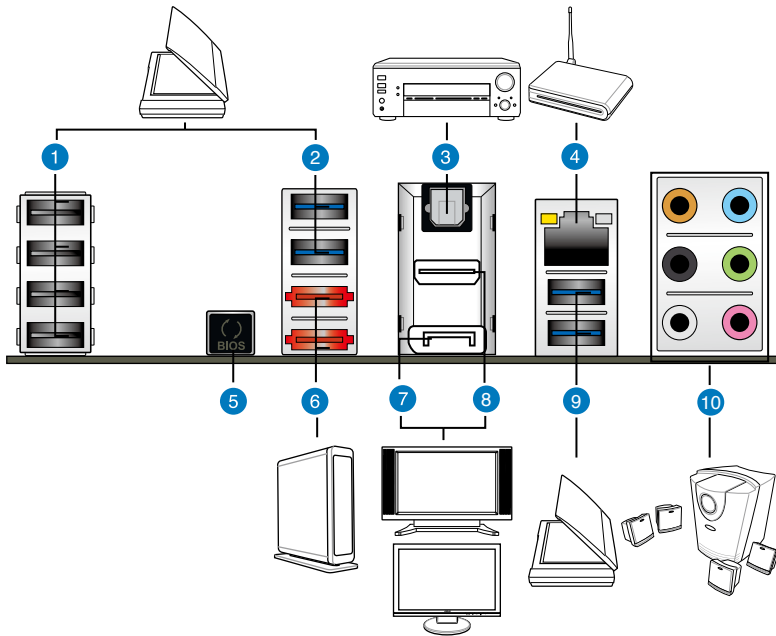

Rear panel connectors

1. USB 2.0 ports 1, 2, 3 and 4	6. External SATA 6G
2. USB 3.0 ports 5 and 6	7. DisplayPort
3. Optical S/PDIF Out port	8. HDMI port
4. LAN (RJ-45) port*	9. USB 3.0 ports 1 and 2***
5. USB BIOS Flashback button	10. Audio I/O ports**

* and **: Refer to the tables on the next page for LAN port LED and audio port definitions.

*** USB 3.0 ports 1 and 2 only support Windows 7 or later versions. The bottom port of USB3_12 supports USB Charger+ and USB BIOS Flashback.



- DO NOT insert a different connector to the external SATA port.
- DO NOT connect a keyboard/mouse to any USB 3.0 port when installing Windows® operating system.
- Due to USB 3.0 controller limitation, USB 3.0 devices can only be used under Windows® OS environment and after the USB 3.0 driver installation.
- USB 3.0 devices can only be used as data storage only.
- We strongly recommend that you connect USB 3.0 devices to USB 3.0 ports for faster and better performance for your USB 3.0 devices.
- If you want to use the hot-plug function of the external SATA ports, you have to set the ASM1061 Storage Controller item in the BIOS setting to [AHCI Mode] and install the Asmedia SATA Controller Driver from the motherboard support DVD. Refer to section 3.5.5 Onboard Devices Configuration for details.

* LAN ports LED indications

Activity Link LED		Speed LED	
Status	Description	Status	Description
OFF	No link	OFF	10 Mbps connection
ORANGE	Linked	ORANGE	100 Mbps connection
BLINKING	Data activity	GREEN	1 Gbps connection

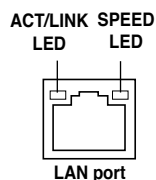

** Audio 2, 4, 6, or 8-channel configuration

Port	Headset 2-channel	4-channel	6-channel	8-channel
Light Blue	Line In	Line In	Line In	Line In
Lime	Line Out	Front Speaker Out	Front Speaker Out	Front Speaker Out
Pink	Mic In	Mic In	Mic In	Mic In
Orange	–	–	Center/Subwoofer	Center/Subwoofer
Black	–	Rear Speaker Out	Rear Speaker Out	Rear Speaker Out
Gray	–	–	–	Side Speaker Out

2.3.11 Audio I/O connections

Audio I/O ports

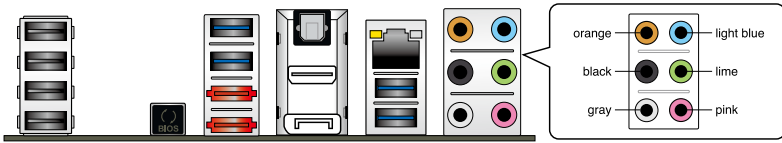

Connect to Headphone and Mic

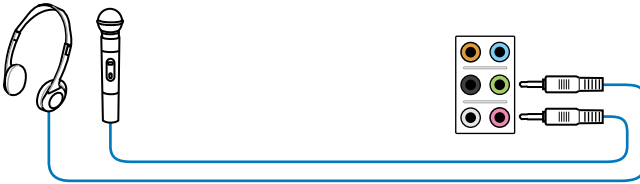

Connect to Stereo Speakers

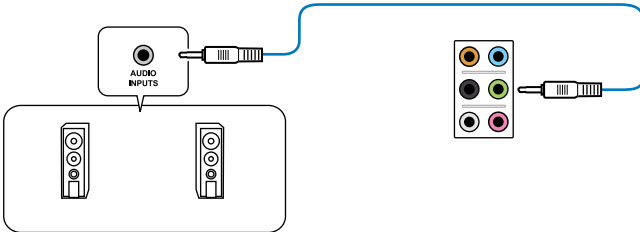

Connect to 2.1 channel Speakers

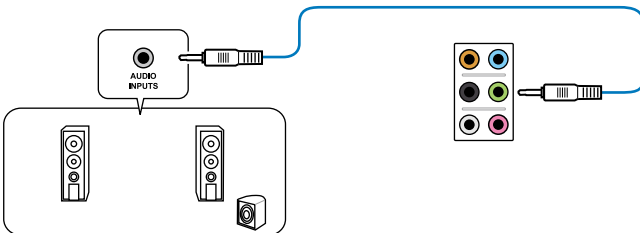

Connect to 4.1 channel Speakers

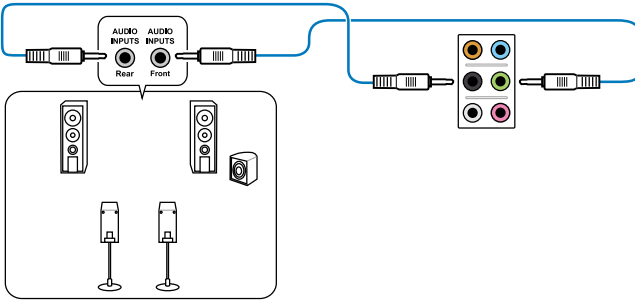

Connect to 5.1 channel Speakers

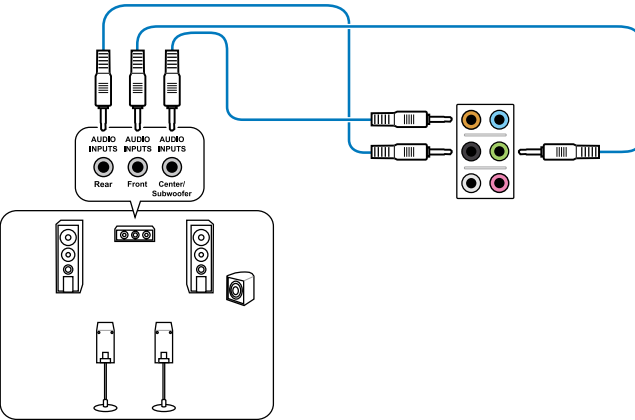

Connect to 7.1 channel Speakers

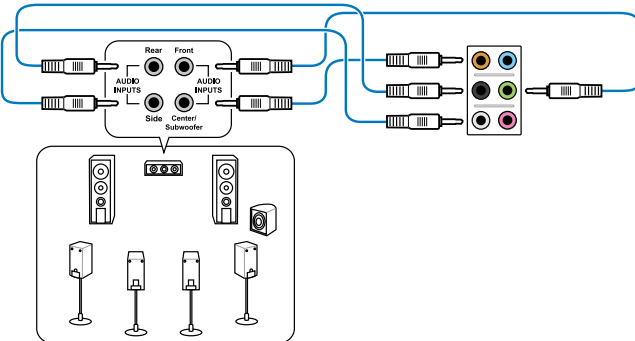

2.3.12 USB BIOS Flashback

USB BIOS Flashback allows you to update the BIOS without entering the BIOS or operating system. Just connect the USB storage device containing the BIOS file to the USB port, press the BIOS Flashback button, and the BIOS is updated automatically.

1. Download the USB BIOS Flashback from the ASUS website at www.asus.com and save it to the root directory of your USB flash drive.
2. Connect the USB flash drive to the bottom USB 3.0 port at the rear panel.
3. Press the USB Flashback button for three seconds until the LED flashes. The LED goes out when the BIOS update is completed.

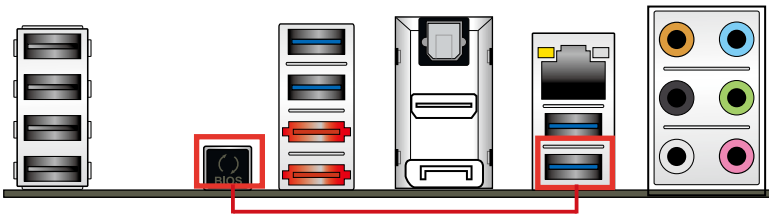

1. Do not disconnect the USB flash drive or power system, or press the CLR_CMOS button during the BIOS updating process. Doing so will interrupt the BIOS updating process. In case of interruption, follow the steps again to update the BIOS.
2. If LED flashes for five seconds and turns into a stable light, this indicates that USB BIOS Flashback is not working properly due to improper USB flash drive connection, BIOS file name error, or incompatible BIOS file format. If this happens, restart the system.
3. BIOS updating poses some risks. If the BIOS program is damaged during the updating process and the system fails to reboot, please contact your local ASUS Service Center for assistance.

2.4 Starting up for the first time

1. After making all the connections, replace the system case cover.
2. Be sure that all switches are off.
3. Connect the power cord to the power connector at the back of the system chassis.
4. Connect the power cord to a power outlet that is equipped with a surge protector.
5. Turn on the devices in the following order:
 - a. Monitor
 - b. External SCSI devices (starting with the last device on the chain)
 - c. System power
6. After applying power, the system power LED on the system front panel case lights up. For systems with ATX power supplies, the system LED lights up when you press the ATX power button. If your monitor complies with the “green” standards or if it has a “power standby” feature, the monitor LED may light up or change from orange to green after the system LED turns on.

The system then runs the power-on self tests or POST. While the tests are running, the BIOS beeps (refer to the BIOS beep codes table below) or additional messages appear on the screen. If you do not see anything within 30 seconds from the time you turned on the power, the system may have failed a power-on test. Check the jumper settings and connections or call your retailer for assistance.

BIOS Beep	Description
One short beep	VGA detected Quick boot set to disabled No keyboard detected
One continuous beep followed by two short beeps then a pause (repeated)	No memory detected
One continuous beep followed by three short beeps	No VGA detected
One continuous beep followed by four short beeps	Hardware component failure

7. At power on, hold down the <Delete> key to enter the BIOS Setup. Follow the instructions in **Chapter 3**.

2.5 Turning off the computer

While the system is ON, pressing the power switch for less than four seconds puts the system on sleep mode or soft-off mode, depending on the BIOS setting. Pressing the power switch for more than four seconds lets the system enter the soft-off mode regardless of the BIOS setting.

Chapter 3

3.1 Knowing BIOS



The new ASUS UEFI BIOS is an Unified Extensible Firmware Interface that complies with UEFI architecture, offering a user-friendly interface that goes beyond traditional keyboard-only BIOS controls to enable more flexible and convenient mouse input. Users can easily navigate the new UEFI BIOS with the same smoothness as their operating system. The term "BIOS" in this user manual refers to "UEFI BIOS" unless otherwise specified.

BIOS (Basic Input and Output System) stores system hardware settings such as storage device configuration, overclocking settings, advanced power management, and boot device configuration that are needed for system startup in the motherboard CMOS. In normal circumstances, the default BIOS settings apply to most conditions to ensure optimum performance. **We recommend that you not change the default BIOS settings** except in the following circumstances:

- An error message appears on the screen during the system bootup and requests you to run the BIOS Setup.
- You have installed a new system component that requires further BIOS settings or update.



Inappropriate settings of the BIOS may result to instability or failure to boot. **We strongly recommend that you change the BIOS settings only with the help of a trained service personnel.**

3.2 BIOS setup program

A BIOS setup program is provided for BIOS item modification. When you start up the computer, the system provides you with the opportunity to run this program. Press during the Power-On Self-Test (POST) to enter the Setup utility. Otherwise, POST continues with its test routines.

If you wish to enter Setup after POST, press <Ctrl> + <Alt> + <Delete>, or press the reset button on the system chassis to restart the system. You can also turn the system off and then turn it back on to restart the system. Do this last option only if the first two failed.



- The BIOS setup screens shown in this section are for reference purposes only, and may not exactly match what you see on your screen.
- Ensure that a USB mouse is connected to your motherboard if you want to use the mouse to control the BIOS setup program.
- If the system becomes unstable after changing any BIOS setting, load the default settings to ensure system compatibility and stability. Select the **Load Optimized Defaults** item under the **Exit** menu. See section **3.9 Exit Menu** for details.
- If the system fails to boot after changing any BIOS setting, try to clear the CMOS and reset the motherboard to the default value. See section **2.2.5 Jumper** for information on how to erase the RTC RAM.
- The BIOS setup program does not support the bluetooth devices.

The BIOS setup program is designed to make it as easy to use as possible. Being a menu-driven program, it lets you scroll through the various submenus and select from the available options using a keyboard or a USB mouse.

The BIOS setup program can be used under two modes: **EZ Mode** and **Advanced Mode**. You can change modes from the **Exit** menu or from the **Exit/Advanced Mode** button in the **EZ Mode/Advanced Mode** screen.

3.2.1 EZ Mode

By default, the EZ Mode screen appears when you enter the BIOS setup program. The EZ Mode provides you an overview of the basic system information, and allows you to select the display language, system performance mode and boot device priority. To access the Advanced Mode, click **Exit/Advanced Mode**, then select **Advanced Mode**.



The default screen for entering the BIOS setup program can be changed. Refer to the **Setup Mode** item in section 3.7 **Boot menu** for details.

Displays the CPU/motherboard temperature, CPU/5V/3.3V/12V voltage output, CPU/CPU_OPT/Chassis fan speed

Selects the display language of the BIOS setup program

Clicks to display all fan speeds if available

Exits the BIOS setup program without saving the changes, saves the changes and resets the system, or enters the Advanced Mode

Quick switch to frequently used menus.

Quick switch to Advanced mode menus.

Selects the boot device priority

Power Saving mode

Normal mode

ASUS Optimal mode

Loads optimized default

Selects the boot device priority

Displays the system properties of the selected mode on the right hand side



- The boot device options vary depending on the devices you installed to the system.
- The **Boot Menu(F8)** button is available only when the boot device is installed to the system.

3.2.2 Advanced Mode

The Advanced Mode provides advanced options for experienced end-users to configure the BIOS settings. The figure below shows an example of the Advanced Mode. Refer to the following sections for the detailed configurations.



To access the EZ Mode, click **Exit**, then select **ASUS EZ Mode**.

The screenshot shows the BIOS Advanced Mode interface. Labels with red lines point to the following elements:

- Back button:** A button with a left-pointing arrow and the word "Back".
- Menu items:** A list of menu items: Main, AI Tweaker, Advanced, Monitor, Boot, and Tool.
- Menu bar:** A horizontal bar at the top containing the menu items.
- Configuration fields:** A list of settings on the left, such as "HD Audio Controller", "Front Panel Type", "SPDIF Out Type", "PCI Express X16_3 slot (black) bandwidth", "ASM1061 Storage Controller (Front)", "ASM101 Storage OPROM", "ASM1061 Storage Controller (Front)", "ASM1061 Storage OPROM", "ASmedia USB 3.0 Controller (USB3_E12)", "ASmedia USB 3.0 Battery Charging Support", "Intel LAN Controller", and "Intel PXE OPROM".
- General help:** A box containing a list of navigation keys: ←: Select Screen, ↑↓: Select Item, Enter: Select, +/-: Change Opt., F1: General Help, F2: Previous Values, F5: Optimized Defaults, F10: Save ESC: Exit, F12: Print Screen.
- Submenu item:** A small square icon at the bottom left of the configuration list.
- Pop-up window:** A window showing "ASM1061 Storage OPROM" with "Enabled" selected.
- Scroll bar:** A vertical slider control next to the configuration list.
- Navigation keys:** A box containing a list of navigation keys: ←: Select Screen, ↑↓: Select Item, Enter: Select, +/-: Change Opt., F1: General Help, F2: Previous Values, F5: Optimized Defaults, F10: Save ESC: Exit, F12: Print Screen.

Menu bar

The menu bar on top of the screen has the following main items:

Main	For changing the basic system configuration
AI Tweaker	For changing the overclocking settings
Advanced	For changing the advanced system settings
Monitor	For displaying the system temperature, power status, and changing the fan settings.
Boot	For changing the system boot configuration
Tool	For configuring options for special functions
Exit	For selecting the exit options and loading default settings

Menu items

The highlighted item on the menu bar displays the specific items for that menu. For example, selecting **Main** shows the Main menu items.

The other items (Ai Tweaker, Advanced, Monitor, Boot, Tool, and Exit) on the menu bar have their respective menu items.

Back button

This button appears when entering a submenu. Press <Esc> or use the USB mouse to click this button to return to the previous menu screen.

Submenu items

A greater than sign (>) before each item on any menu screen means that the item has a submenu. To display the submenu, select the item and press <Enter>.

Pop-up window

Select a menu item and press <Enter> to display a pop-up window with the configuration options for that item.

Scroll bar

A scroll bar appears on the right side of a menu screen when there are items that do not fit on the screen. Press the Up/Down arrow keys or <Page Up> / <Page Down> keys to display the other items on the screen.

Navigation keys

At the bottom right corner of the menu screen are the navigation keys for the BIOS setup program. Use the navigation keys to select items in the menu and change the settings. Use <F12> key to capture the BIOS screen and save it to the removable storage device.

General help

At the top right corner of the menu screen is a brief description of the selected item.

Configuration fields

These fields show the values for the menu items. If an item is user-configurable, you can change the value of the field opposite the item. You cannot select an item that is not user-configurable.

A configurable field is highlighted when selected. To change the value of a field, select it and press <Enter> to display a list of options.

3.3 Main menu

The Main menu screen appears when you enter the Advanced Mode of the BIOS Setup program. The Main menu provides you an overview of the basic system information, and allows you to set the system date, time, language, and security settings.



Security

The Security menu items allow you to change the system security settings.

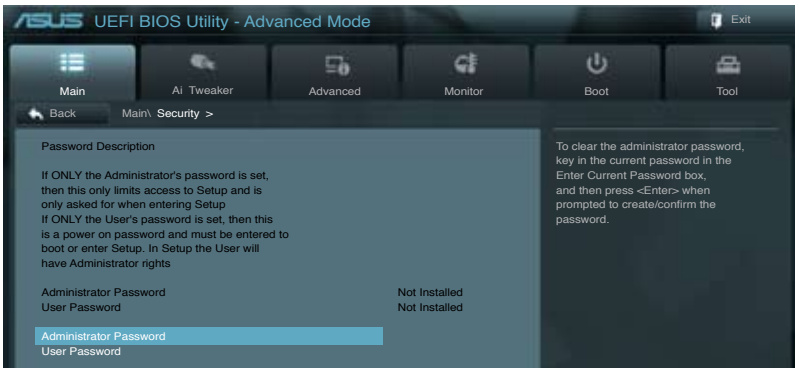

- If you have forgotten your BIOS password, erase the CMOS Real Time Clock (RTC) RAM to clear the BIOS password. See section **2.2.5 Jumper** for information on how to erase the RTC RAM.
- The **Administrator** or **User Password** items on top of the screen show the default **Not Installed**. After you set a password, these items show **Installed**.

Administrator Password

If you have set an administrator password, we recommend that you enter the administrator password for accessing the system. Otherwise, you might be able to see or change only selected fields in the BIOS setup program.

To set an administrator password:

1. Select the **Administrator Password** item and press <Enter>.
2. From the **Create New Password** box, key in a password, then press <Enter>.
3. Confirm the password when prompted.

To change an administrator password:

1. Select the **Administrator Password** item and press <Enter>.
2. From the **Enter Current Password** box, key in the current password, then press <Enter>.
3. From the **Create New Password** box, key in a new password, then press <Enter>.
4. Confirm the password when prompted.

To clear the administrator password, follow the same steps as in changing an administrator password, but press <Enter> when prompted to create/confirm the password. After you clear the password, the **Administrator Password** item on top of the screen shows **Not Installed**.

User Password

If you have set a user password, you must enter the user password for accessing the system. The **User Password** item on top of the screen shows the default **Not Installed**. After you set a password, this item shows **Installed**.

To set a user password:

1. Select the **User Password** item and press <Enter>.
2. From the **Create New Password** box, key in a password, then press <Enter>.
3. Confirm the password when prompted.

To change a user password:

1. Select the **User Password** item and press <Enter>.
2. From the **Enter Current Password** box, key in the current password, then press <Enter>.
3. From the **Create New Password** box, key in a new password, then press <Enter>.
4. Confirm the password when prompted.

To clear the user password, follow the same steps as in changing a user password, but press <Enter> when prompted to create/confirm the password. After you clear the password, the **User Password** item on top of the screen shows **Not Installed**.

3.4 Ai Tweaker menu

The Ai Tweaker menu items allow you to configure overclocking-related items.



Be cautious when changing the settings of the Ai Tweaker menu items. Incorrect field values can cause the system to malfunction.



The configuration options for this section vary depending on the CPU and DIMM model you installed on the motherboard.

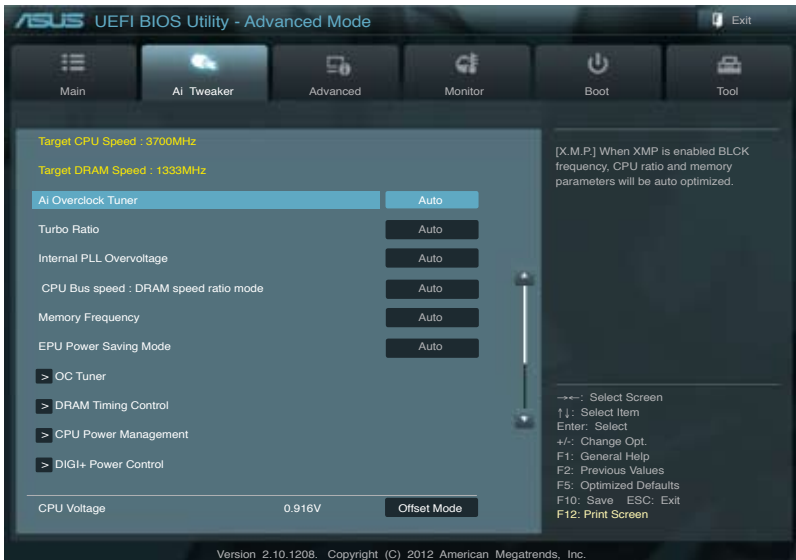

Scroll down to display the following items:

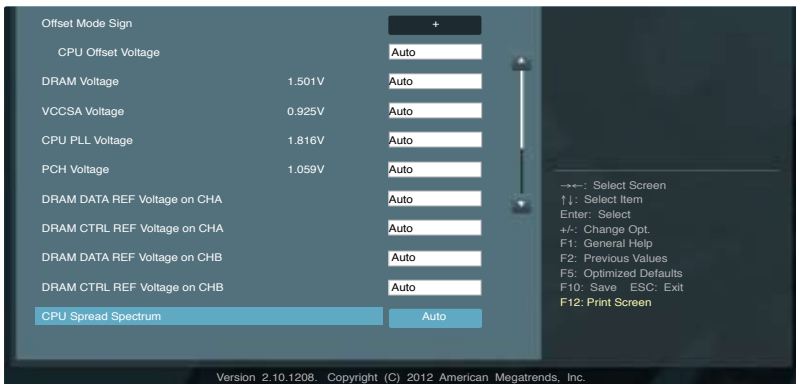

Ai Overclock Tuner [Auto]

Allows you to select the CPU overclocking options to achieve the desired CPU internal frequency. Select any of these preset overclocking configuration options:

- [Auto] Loads the optimal settings for the system.
- [Manual] Allows you to individually set overclocking parameters.
- [X.M.P.] If you install memory modules supporting the eXtreme Memory Profile (X.M.P.) Technology, choose this item to set the profiles supported by your memory modules for optimizing the system performance.



The following two items appear only when you set the Ai Overclocking Tuner to [Manual].

BCLK/PCIE Frequency [XXX]

Allows you to adjust the CPU and VGA frequency to enhance the system performance. Use the <+> and <-> keys to adjust the value. You can also key in the desired value using the numeric keypad. The values range from 80.0MHz to 300.0MHz.

eXtreme Memory Profile

This item appears only when you set the Ai Overclocking Tuner item to [X.M.P.] and allows you to select the X.M.P. mode supported by your memory module.

Configuration options: [Profile #1] [Profile #2]

Turbo Ratio [Auto]

Allows you to set the CPU ratio automatically or manually.

- [Auto] Sets all Turbo Ratio to Intel® CPU default settings automatically.
- [Manual] Sets the Turbo Ratio for every core-activation condition of a full unlocked CPU manually.



When the Turbo Ratio is set to [Manual], the following item appears:

Ratio Synchronizing Control [Enabled]

- [Enabled] Allows you to set an individual Turbo Ratio for every core-activation condition
- [Disabled] Allows you to set one single Turbo Ratio for all core-activation conditions.

1-Core Ratio Limit [Auto]

Allows you to set the 1-Core Ratio Limit

- [Auto] Select to apply the CPU default Turbo Ratio setting
- [Manual] Select to manually assign a 1-Core Ratio Limit value that is higher than or equal to the 2-Core Ratio Limit.

2-Core Ratio Limit [Auto]

Allows you to set the 2-Core Ratio Limit

- [Auto] Select to apply the CPU default Turbo Ratio setting
- [Manual] Select to manually assign a 2-Core Ratio Limit value that is higher than or equal to the 3-Core Ratio Limit. 1-Core Limit must not be set to [Auto]

3-Core Ratio Limit [Auto]

Allows you to set the 3-Core Ratio Limit

[Auto] Select to apply the CPU default Turbo Ratio setting

[Manual] Select to manually assign a 3-Core Ratio Limit value that is higher than or equal to the 4-Core Ratio Limit. 1-Core/2-Core Ratio Limit must not be set to [Auto]

4-Core Ratio Limit [Auto]

Allows you to set the 4 Core Ratio Limit

[Auto] Select to apply the CPU default Turbo Ratio setting

[Manual] Select to manually assign a 4-Core Ratio Limit value that is higher than or equal to the 3-Core Ratio Limit. 1-Core/2-Core/3-Core Limit must not be set to [Auto]

Internal PLL Overvoltage [Auto]

Allows you to set the internal PLL voltage.

Configuration options: [Auto] [Enabled] [Disabled]

Memory Frequency [Auto]

Allows you to set the memory operating frequency. The configuration options vary with the BCLK/PCIE Frequency item settings.

CPU bus speed : DRAM speed ratio mode [Auto]

Allows you to set the CPU bus speed to DRAM speed ratio mode.

[Auto] DRAM speed is set to the optimized settings.

[100:133] The CPU bus speed to DRAM speed ratio is set to 100:133.

[100:100] The CPU bus speed to DRAM speed ratio is set to 100:100.

EPU Power Saving Mode [Disabled]

Allows you to enable or disable the EPU power saving function.

Configuration options: [Disabled] [Enabled]

EPU Setting [Auto]

This item appears only when you set the **EPU Power Saving MODE** item to [Enabled.] and allows you to select the EPU power saving mode.

Configuration options: [Auto] [Light Power Saving Mode] [Medium Power Saving Mode] [Max Power Saving Mode]

OC Tuner

OC Tuner automatically overclocks the frequency and voltage of CPU and DRAM for enhancing the system performance. Configuration options: [OK] [Cancel]

DRAM Timing Control

The sub-items in this menu allow you to set the DRAM timing control features. Use the <+> and <-> keys to adjust the value. To restore the default setting, type [auto] using the keyboard and press the <Enter> key.



Changing the values in this menu may cause the system to become unstable! If this happens, revert to the default settings.

ASUS UEFI BIOS Utility - Advanced Mode

Main | **AI Tweaker** | Advanced | Monitor | Boot | Tool

Back | AI Tweaker > DRAM Timing Control >

Primary Timings			
DRAM CAS# Latency	CHA:	9	Auto
DRAM RAS# to CAS# Delay	CHA:	9	Auto
DRAM RAS# PRE Time	CHA:	9	Auto
DRAM RAS# ACT Time	CHA:	24	Auto
DRAM COMMAND Mode	CHA:	1	Auto
Secondary Timings			
DRAM RAS# to RAS# Delay	CHA:	4	Auto
DRAM REF Cycle Time	CHA:	74	Auto
DRAM Refresh Interval	CHA:	5200	Auto
DRAM WRITE Recovery Time	CHA:	10	Auto
DRAM READ to PRE Time	CHA:	5	Auto
DRAM FOUR ACT WIN Time	CHA:	20	Auto
DRAM WRITE to READ Delay	CHA:	5	Auto
DRAM CKE Minimum pulse width	CHA:	4	Auto
DRAM CAS# Write Latency	CHA:	7	Auto

DRAM CAS# Latency

--- Select Screen
 ↑↓: Select Item
 Enter: Select
 +/-: Change Opt.
 F1: General Help
 F2: Previous Values
 F5: Optimized Defaults
 F10: Save ESC: Exit
 F12: Print Screen

Version 2.10.1208. Copyright (C) 2012 American Megatrends, Inc.

Scroll down to display the following items:

DRAM RTL (CHA) CHA DO: 32, CHA D1: 35 Auto

DRAM RTL (CHB) Auto

DRAM IO-L (CHA) CHA DO: 0, CHA D1: 2 Auto

DRAM IO-L (CHB) 2 Auto

Third Timings

↑RDDR (DD) CHA: 1 Auto

↑RWDR (DD) CHA: 3 Auto

↑RWSR CHA: 3 Auto

↑RR (DD) CHA: 3 Auto

↑RR (DR) CHA: 1 Auto

↑RRSR CHA: 4 Auto

↑WW (DD) CHA: 3 Auto

↑WW (DR) CHA: 3 Auto

↑WWSR CHA: 4 Auto

MISC

MRC fast Boot Enabled

--- Select Screen
 ↑↓: Select Item
 Enter: Select
 +/-: Change Opt.
 F1: General Help
 F2: Previous Values
 F5: Optimized Defaults
 F10: Save ESC: Exit
 F12: Print Screen

Version 2.10.1208. Copyright (C) 2012 American Megatrends, Inc.

Scroll down to display the following items:

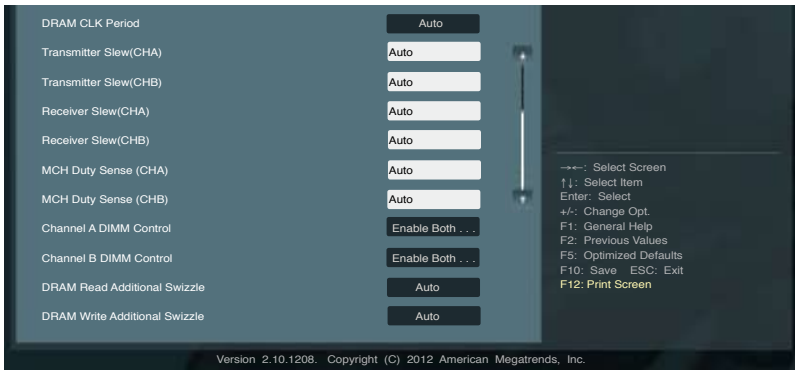

Primary Timings

DRAM CAS# Latency [Auto]

Configuration options: [Auto] [3 DRAM Clock] – [15 DRAM Clock]

DRAM RAS# to CAS# Delay [Auto]

Configuration options: [Auto] [4 DRAM Clock] – [15 DRAM Clock]

DRAM RAS# PRE Time [Auto]

Configuration options: [Auto] [4 DRAM Clock] – [15 DRAM Clock]

DRAM RAS# ACT Time [Auto]

Configuration options: [Auto] [4 DRAM Clock] – [40 DRAM Clock]

DRAM COMMAND Mode [Auto]

Configuration options: [Auto] [1 DRAM Clock] [2 DRAM Clock] [3 DRAM Clock]

Secondary Timings

DRAM RAS# to RAS# Delay [Auto]

Configuration options: [Auto] [4 DRAM Clock] – [7 DRAM Clock]

DRAM REF Cycle Time [Auto]

Configuration options: [Auto] [48 DRAM Clock] – [511 DRAM Clock]

DRAM Refresh Interval [Auto]

Configuration options: [Auto] [48 DRAM Clock] – [511 DRAM Clock]

DRAM WRITE Recovery Time [Auto]

Configuration options: [Auto] [5 DRAM Clock] – [31 DRAM Clock]

DRAM READ to PRE Time [Auto]

Configuration options: [Auto] [4 DRAM Clock] – [15 DRAM Clock]

DRAM FOUR ACT WIN Time [Auto]

Configuration options: [Auto] [16 DRAM Clock] – [63 DRAM Clock]

DRAM WRITE to READ Delay [Auto]

Configuration options: [Auto] [4 DRAM Clock] – [15 DRAM Clock]

DRAM CKE Minimum pulse width [Auto]

Configuration options: [Auto] [4 DRAM Clock] – [15 DRAM Clock]

DRAM CAS# Write to Latency [Auto]

Configuration options: [Auto] [1 DRAM Clock] – [15 DRAM Clock]

DRAM RTL (CHA) [Auto]

Configuration options: [Auto] [1 DRAM Clock] – [15 DRAM Clock]

DRAM RTL (CHB) [Auto]

Configuration options: [Auto] [1 DRAM Clock] – [15 DRAM Clock]

DRAM IO-L (CHA) [Auto]

Configuration options: [Auto] [Delay 1 Clock] – [Delay 15 Clock]

DRAM IO-L (CHB) [Auto]

Configuration options: [Auto] [Delay 1 Clock] – [Delay 15 Clock]

Third Timings*tWRDR (DD) [Auto]*

Configuration options: [Auto] [0 DRAM Clock] – [7 DRAM Clock]

tRWDR (DD) [Auto]

Configuration options: [Auto] [0 DRAM Clock] – [15 DRAM Clock]

tRWSR [Auto]

Configuration options: [Auto] [0 DRAM Clock] – [15 DRAM Clock]

tRR (DD) [Auto]

Configuration options: [Auto] [0 DRAM Clock] – [7 DRAM Clock]

tRR (DR) [Auto]

Configuration options: [Auto] [0 DRAM Clock] – [7 DRAM Clock]

tRRSR [Auto]

Configuration options: [Auto] [0 DRAM Clock] – [15 DRAM Clock]

tWW (DD) [Auto]

Configuration options: [Auto] [0 DRAM Clock] – [7 DRAM Clock]

tWW (DR) [Auto]

Configuration options: [Auto] [0 DRAM Clock] – [7 DRAM Clock]

tWWSR [Auto]

Configuration options: [Auto] [0 DRAM Clock] – [15 DRAM Clock]

MISC*MRC Fast Boot [Enabled]*

Allows you to enable or disable the MRC fast boot.

[Enabled] Enables the MRC fast boot.

[Disable] Disables the function.

DRAM CLK Period [Auto]

Allows you to set the DRAM CLK Period.

Configuration options: [Auto] [1] [2] [3] [4] [5] [6] [7] [8] [9] [10] [11] [12] [13] [14]

Transmitter Slew(CHA) [Auto]

Configuration options: [Auto] [1 CHA Transmitter slew] – [7 CHA Transmitter slew]

Transmitter Slew(CHB) [Auto]

Configuration options: [Auto] [1 CHB Transmitter slew] – [7 CHB Transmitter slew]

Receiver Slew(CHA) [Auto]

Configuration options: [Auto] [1 CHA Receiver slew] – [7 CHA Receiver slew]

Receiver Slew(CHB) [Auto]

Configuration options: [Auto] [1 CHB Receiver slew] – [7 CHB Receiver slew]

MCH Duty Sense (CHA) [Auto]

Configuration options: [Auto] [1 CHA MCH Duty Sense] – [31 CHA MCH Duty Sense]

MCH Duty Sense (CHB) [Auto]

Configuration options: [Auto] [1 CHB MCH Duty Sense] – [31 CHB MCH Duty Sense]

Channel A DIMM Control [Enable Both DIMMs]

Allows you to enable or disable DIMMs on Channel A slots.

[Enable Both DIMMs]	Enables both Channel A DIMMs
[Disable DIMM0]	Disables DIMM0 slot
[Disable DIMM1]	Disables DIMM1 slot
[Disable Both DIMMs]	Disables both Channel A DIMMs

Channel B DIMM Control [Enable Both DIMMs]

Allows you to enable or disable DIMMs on Channel A slots.

[Enable Both DIMMs]	Enables both Channel B DIMMs
[Disable DIMM0]	Disables DIMM0 slot
[Disable DIMM1]	Disables DIMM1 slot
[Disable Both DIMMs]	Disables both Channel B DIMMs

DRAM Read Additional Swizzle

Configuration options: [Auto] [Enabled] [Disabled]

DRAM Write Additional Swizzle

Configuration options: [Auto] [Enabled] [Disabled]

CPU Power Management

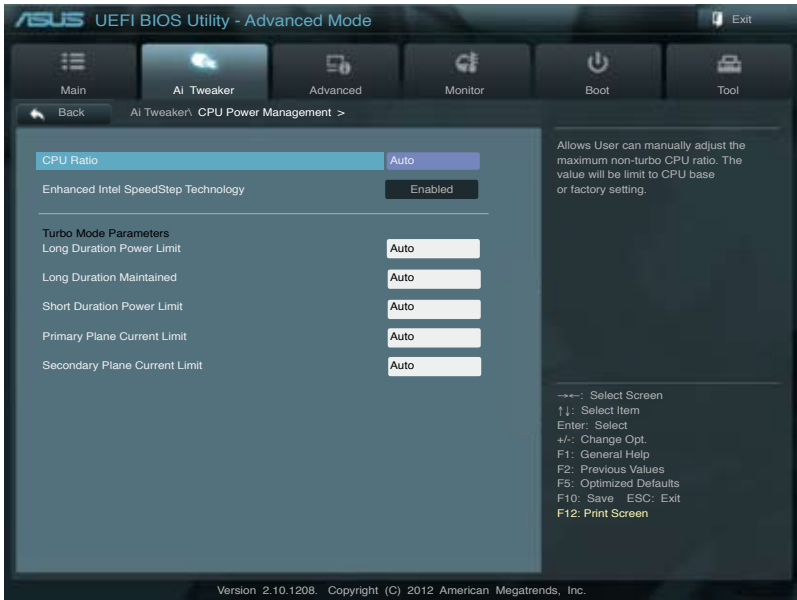

CPU Ratio [Auto]

Allows you to manually adjust the maximum non-turbo CPU ratio. Use <+> and <-> keys to adjust the value. The valid value ranges vary according to your CPU model.

Enhanced Intel SpeedStep Technology [Enabled]

Allows you to enable or disable the Enhanced Intel® SpeedStep Technology.

[Disabled] Disables this function.

[Enabled] The operating system dynamically adjusts the processor voltage and core frequency which may result in decreased average consumption and decreased average heat production.

Turbo Mode Parameters

Long Duration Power Limit [Auto]

Allows you to limit the turbo ratio's long duration power.
Use the <+> and <-> keys to adjust the value.

Long Duration Maintained [Auto]

Allows you to maintain the turbo ratio's long duration power.
Use the <+> and <-> keys to adjust the value.

Short Duration Power Limit [Auto]

Allows you to limit the turbo ratio's long duration power.
Use the <+> and <-> keys to adjust the value.

Primary Plane Current Limit [Auto]

Maximum instantaneous current allowed at any given time for CPU cores
Use <+> and <-> key to adjust the value at 0.125A increment. .

Secondary Plane Current Limit [Auto]

Maximum instantaneous current allowed at any given time for Internal Graphics cores.
Use <+> and <-> key to adjust the value at 0.125A increment.

DIGI+ Power Control



CPU Load-Line Calibration [Auto]

Load-line is defined by Intel VRM spec and affects CPU voltage. The CPU working voltage will decrease proportionally to CPU loading. Higher value gets a higher voltage and better overclocking performance, but increases the CPU and VRM thermal. This item allows you to adjust the voltage range from the following percentages to boost the system performance: 0% (Regular), 25% (Medium), 50% (High), 75% (Ultra High) and 100% (Extreme).

Configuration options: [Auto] [Regular] [Medium] [High] [Ultra High] [Extreme]



The actual performance boost may vary depending on your CPU specification.

CPU Voltage Frequency [Auto]

Frequency switching affects the VRM transient response, and the thermal component. Higher frequency gets quicker transient response.
Configuration options: [Auto] [Manual]



DO NOT remove the thermal module when switching to Manual Mode. The thermal conditions should be monitored.

VRM Spread Spectrum [Disabled]

This item appears only when you set the **Frequency** item to [Auto] and allows you to enable the spread spectrum to enhance system stability.

CPU Power Phase Control [Standard]

Allows you to control the power phase based on the CPU's demands.
Configuration options: [Standard] [Optimized] [Extreme] [Manual Adjustment]



DO NOT remove the thermal module when switching to Extreme and Manual Mode. The thermal conditions should be monitored.

CPU Power Duty Control [T.Probe]

DIGI + VRM Duty control adjusts the current and thermal conditions of every component's phase.
Configuration options: [T. Probe] - Select to maintain the VRM thermal balance.
[Extreme] - Select to maintain the current VRM balance.

CPU Current Capability [100%]

Allows you to configure the total power range, and extends the overclocking frequency range simultaneously.
Configuration options: [100%] [110%] [120%] [130%] [140%]



Choose a higher value when overclocking, or under a high CPU loading for extra power support.

CPU Power Thermal Control [130]

Allows you to extend the overclocking tolerance to enlarge the overclocking potential and provides a wider power thermal range.
Press <+> or <-> to set a value.



DO NOT remove the thermal module. Thermal conditions must be monitored regularly.

CPU Power Response Control [Auto]

Allows you to set a precise power response rate for your CPU for an extreme overclocking.
Configuration options: [Auto] [Regular: 100] [Medium: 150] [High: 200] [Ultra High: 250]



The actual performance boost varies depending on your CPU specification.

iGPU Load-line Calibration [Auto]

Allows you to set the iGPU Load-line Calibration.
Configuration options: [Auto] [Regular] [High] [Extreme]

iGPU Current Capability [100%]

Allows you to set the iGPU Current Capability.

Configuration options: [100%] [110%] [120%] [130%] [140%]



DO NOT remove the thermal module while changing the DIGI+ VRM related parameters . The thermal conditions should be monitored.



Some of the following items above are adjusted by typing the desired values using the numeric keypad and press the <Enter> key. You can also use the <+> and <-> keys to adjust the value. To restore the default setting, type [auto] using the keyboard and press the <Enter> key.

DRAM Current Capability [100%]

Allows you to set the DRAM Current Capability to a higher value for a wider total power range, and extends the overclocking frequency range.

Configuration options: [100%] [110%] [120%] [130%]

DRAM Voltage Frequency [Auto]

Allows you to adjust the DRAM switching frequency.

Configuration options: [Auto] [Manual]

DRAM Power Phase Control [Auto]

Allows you to set the tuning profile

[Auto] Sets the default configuration.

[Optimized] Sets the ASUS optimized phase tuning profile.

[Extreme] Sets the full phase mode.

DRAM Power Thermal Control [110]

Allows you to set a higher temperature for a wider DRAM power thermal range, and extends the overclocking tolerance for overclocking potential.

Press <+> or <-> to set a value.



DO NOT remove the thermal module. Thermal conditions must be monitored regularly.

CPU Voltage [Offset Mode]

[Manual Mode] Allows you to set a fixed CPU voltage.

[Offset Mode] Allows you to set the Offset voltage.

Offset Mode Sign [+]

This item appears only when you set the **CPU Voltage** item to [Offset Mode].

[+] To offset the voltage by a positive value.

[-] To offset the voltage by a negative value.

CPU Offset Voltage [Auto]

This item appears only when you set the **CPU Voltage** item to [Offset Mode] and allows you to set the Offset voltage. The values range from 0.005V to 0.635V with a 0.005V interval.

CPU Manual Voltage [Auto]

This item appears only when you set the **CPU Voltage** item to [Manual Mode] and allows you to set a fixed CPU voltage. The values range from 0.800V to 1.990V with a 0.005V interval.



Refer to the CPU documentation before setting the CPU voltage. Setting a high voltage may damage the CPU permanently, and setting a low voltage may make the system unstable.



The following items appears only when you set the **Initiate iGPU** items to [Enabled].

DRAM Voltage [Auto]

Allows you to set the DRAM voltage. The values range from 1.20V to 2.20V with a 0.00625V interval.



According to Intel CPU spec, DIMMs with voltage requirement over 1.65V may damage the CPU permanently. We recommend you install the DIMMs with the voltage requirement below 1.65V.

VCCSA Voltage [Auto]

Allows you to set the VCCSA voltage. The values range from 0.80V to 1.70V with a 0.00625V interval.

CPU PLL Voltage [Auto]

Allows you to set the CPU and PCH PLL voltage. The values range from 1.20V to 2.20V with a 0.00625V interval.

PCH Voltage [Auto]

Allows you to set the Platform Controller Hub volage. The values range from 0.80V to 1.70V with a 0.01V interval.



- The values of the CPU Manual Voltage, CPU Offset Voltage, DRAM Voltage, VCCSA Voltage, VCCIO Voltage, and PCH Voltage items are labeled in different color, indicating the risk levels of high voltage settings.
 - The system may need better cooling system to work stably under high voltage settings.
-

	Black	Yellow	Pink	Red
CPU Manual Voltage	0.8V–1.22V	1.225V–1.280V	1.285V–1.335V	1.340V–1.990V
CPU Offset Voltage	0.005V–0.060V	0.065V–0.120V	0.125V–0.175V	0.180V–0.635V
iGPU Offset Voltage	0.005V–0.035V	0.04V–0.065V	0.07V–0.1V	0.105V–0.635V
DRAM Voltage	1.20000V–1.57500V	1.58125V–1.65000V	1.65625V–1.72500V	1.73125V–2.20000V
VCCSA Voltage	0.80000V–1.10000V	1.10625V–1.15000V	1.15625V–1.20625V	1.21250V–1.70000V
CPU PLL Voltage	1.20000V–1.88750V	1.89375V–1.97500V	1.98125V–2.06875V	2.07500V–2.20000V
PCH Voltage	0.80000V–1.10000V	1.11000V–1.15000V	1.16000V–1.20000V	1.21000V–1.70000V

DRAM DATA REF Voltage on CHA/B [Auto]

Allows you to set the DRAM DATA Reference Voltage on Channel A/B. The values range from 0.395x to 0.630x with a 0.005x interval. Different ratio might enhance DRAM overlocking ability.

DRAM CTRL REF Voltage on CHA/B [Auto]

Allows you to set the DRAM Control Reference Voltage on Channel A/B. The values range from 0.395x to 0.630x with a 0.005x interval. Different ratio might enhance DRAM overlocking ability.

CPU Spread Spectrum [Auto]

- [Auto] Automatic configuration.
- [Disabled] Enhances the BCLK overlocking ability.
- [Enabled] Sets to [Enabled] for EMI control.

3.5 Advanced menu

The Advanced menu items allow you to change the settings for the CPU and other system devices.



Be cautious when changing the settings of the Advanced menu items. Incorrect field values can cause the system to malfunction.



3.5.1 CPU Configuration

The items in this menu show the CPU-related information that the BIOS automatically detects.



The items shown in this screen may be different due to the CPU you installed.



Scroll down to display the following items:

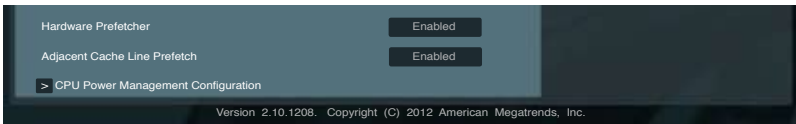

Intel Adaptive Thermal Monitor [Enabled]

[Disabled] Disables the CPU thermal monitor function.

[Enabled] Enables the overheated CPU to throttle its clock speed to cool down.

Hyper-threading [Enabled]

The Intel® Hyper-Threading Technology allows a hyper-threading processor to appear as two logical processors to the operating system, allowing the operating system to schedule two threads, or processes simultaneously.

[Enabled] Two threads per activated core are enabled.

[Disabled] Only one thread per activated core is enabled.

Active Processor Cores [All]

Allows you to choose the number of CPU cores to activate in each processor package.
Configuration options: [All] or by CPU specification

Limit CPUID Maximum [Disabled]

[Enabled] Allows legacy operating systems to boot even without support for CPUs with extended CPUID functions.

[Disabled] For Windows® XP OS, select this option to disable this function.

Execute Disable Bit [Enabled]

[Enabled] Enables the No-Execution Page Protection Technology.

[Disabled] Forces the XD feature flag to always return to zero (0).

Intel Virtualization Technology [Disabled]

[Enabled] Allows a hardware platform to run multiple operating systems separately and simultaneously, enabling one system to virtually function as several systems.

[Disabled] Disables this function.

Hardware Prefetcher [Enabled]

[Enabled] Allows a hardware platform to run multiple operating systems separately and simultaneously, enabling one system to virtually function as several systems.

[Disabled] Disables this function.

Adjacent Cache Line Prefetch [Enabled]

[Enabled] Allows a hardware platform to perform adjacent cache line prefetching.

[Disabled] Disables this function.

CPU Power Management Configuration

This item allows you to manage and configure the CPU's power.

CPU Ratio [Auto]

Allows you to set the ratio between the CPU Core Clock and the BCLK Frequency. Use <+> and <-> keys to adjust the ratio. The valid value ranges vary according to your CPU model.

Enhanced Intel SpeedStep Technology [Enabled]

Allows you to enable or disable the Enhanced Intel® SpeedStep Technology (EIST).

[Disabled] The CPU runs at its default speed.

[Enabled] The operating system controls the CPU speed.

CPU C1E [Auto]

[Auto] Sets the default configuration.

[Disabled] Disables this function.

[Enabled] Enables the C1E support function. This item should be enabled in order to enable the Enhanced Halt State.

CPU C3 Report [Auto]

Allows you to disable or enable the CPU C3 report to OS.

Configuration options: [Auto] [Disabled] [Enabled]

CPU C6 Report [Auto]

Allows you to disable or enable the CPU C6 report to OS.
Configuration options: [Auto] [Disabled] [Enabled]

3.5.2 PCH Configuration

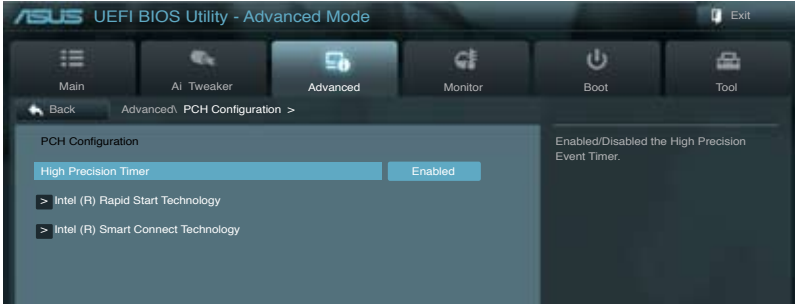

High Precision Timer [Enabled]

Allows you to enable or disable the High Precision Event Timer.
Configuration options: [Disabled] [Enabled]

Intel (R) Rapid Start Technology

Allows you to enable or disable the Intel® Rapid Start Technology function.

Intel (R) Rapid Start Technology [Disabled]

Configuration options: [Disabled] [Enabled]

Entry on S3 RTC Wake [Enabled]

Allows you to enable the system's RTC (real-time clock) wake.
Configuration options: [Disable] [Enable]

Entry After [Immediately]

Allows you to set the system's RTC (real-time clock) wake.
Configuration options: [Immediately] [1 minute] [2 minutes] [5 minutes] [10 minutes] [15 minutes] [30 minutes] [1 hour] [2 hours]

Active Page Threshold Support [Enabled]

This function supports the Intel® Rapid Start Technology with a small partition.
Configuration options: [Enabled] [Disabled]

Active Memory Threshold [0]

Key in the value for the additional partition size. For RST to work, ensure that the caching partition size is larger than the total memory size. When set to [0], the system automatically checks if the partition size is enough for the S3 entry (waketime entry).



The following four items above appear only when you set the **Intel (R) Rapid Start Technology** item to [Enabled].

Intel (R) Smart Connect Technology [Disabled]

Allows you to enable or disable the Intel® Smart Connect Technology configuration.

ISCT Configuration [Disabled]

Configuration options: [Disabled] [Enabled]

3.5.3 SATA Configuration

While entering Setup, the BIOS automatically detects the presence of SATA devices. The SATA Port items show **Not Present** if no SATA device is installed to the corresponding SATA port.

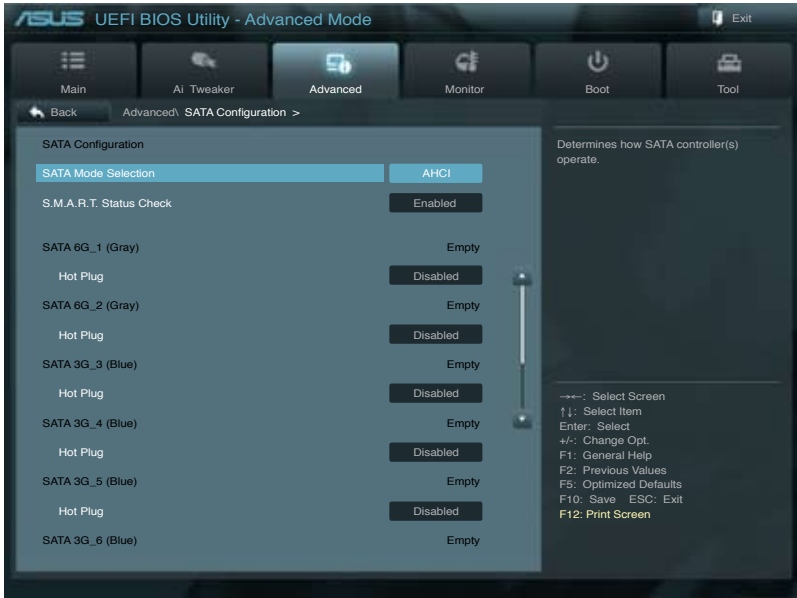

Scroll down to display the following items:

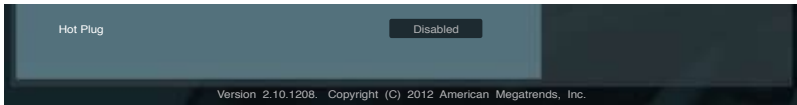

SATA Mode Selection [AHCI]

Allows you to set the SATA configuration.

- [Disabled] Disables the SATA function.
- [IDE Mode] Set to [IDE Mode] when you want to use the Serial ATA hard disk drives as Parallel ATA physical storage devices.
- [AHCI Mode] Set to [AHCI Mode] when you want the SATA hard disk drives to use the AHCI (Advanced Host Controller Interface). The AHCI allows the onboard storage driver to enable advanced Serial ATA features that increases storage performance on random workloads by allowing the drive to internally optimize the order of commands.
- [RAID Mode] Set to [RAID Mode] when you want to create a RAID configuration from the SATA hard disk drives.

S.M.A.R.T. Status Check [Enabled]

S.M.A.R.T. (Self-Monitoring, Analysis and Reporting Technology) is a monitor system. When read/write of your hard disk errors occur, this feature allows the hard disk to report warning messages during the POST. Configuration options: [Enabled] [Disabled]

Hot Plug [Disabled]

These items appear only when you set the **SATA Mode** item to [AHCI Mode] or [RAID Mode] and allow you to enable/disable SATA Hot Plug Support. Configuration options: [Disabled] [Enabled].

3.5.4 System Agent Configuration

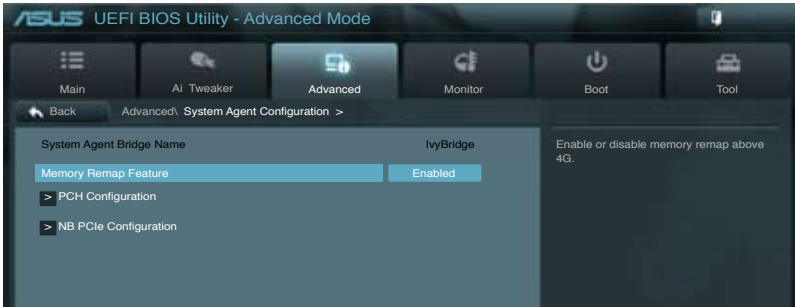

Memory Remap Feature [Enabled]

[Enabled] Allow you to enable remapping the memory above 4GB.

[Disabled] Disables this function.

Graphics Configuration

Allows you to set the graphics configuration for primary display, iGPU memory, render standby, and iGPU initiation functions.

Primary Display [Auto]

Allows you to select the IGFX/PEG graphics device for primary display.

Configuration options: [Auto] [IGFX] [PEG]

iGPU Memory [64M]

Allows you to select a pre-allocated graphics memory size to be used by the internal graphics device.

Configuration options: [32M] [64M] [96M] [128M] [160M] [192M] [224M] [256M] [288M] [320M] [352M] [384M] [416M] [448M] [480M] [512M] [1024M]

Render Standby [Enabled]

Allows you to enable or disable the rendered standby support.

Configuration options: [Enabled] [Disabled]

iGPU Multi-Monitor [Disabled]

Allows you to enable or disable the iGPU Multi-Monitor. Set this item to [Enabled] to activate the Lucid Virtu Universal MVP support function for empowering both integrated and discrete graphics.

Configuration options: [Enabled] [Disabled]

NB PCIe Configuration

Allows you to configure the NB PCI Express settings.

PCIEX16_1 Link Speed [Auto]

Configuration options: [Auto] [Gen1] [Gen2] [Gen3]

PCIEX16_2 Link Speed [Auto]

Configuration options: [Auto] [Gen1] [Gen2] [Gen3]

3.5.5 USB Configuration

The items in this menu allow you to change the USB-related features.

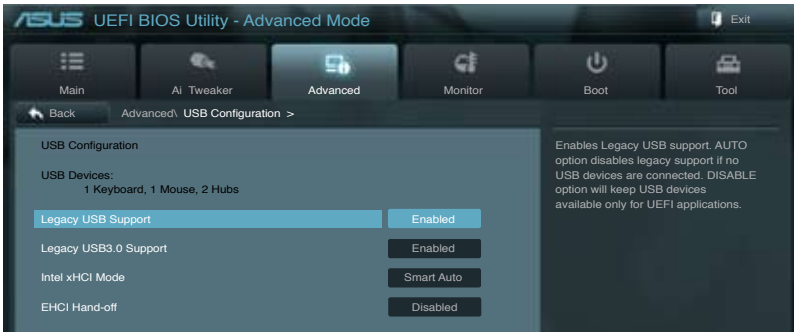

The **USB Devices** item shows the auto-detected values. If no USB device is detected, the item shows **None**.

Legacy USB Support [Enabled]

- [Disabled] The USB devices can be used only for the BIOS setup program.
- [Enabled] Enables the support for USB devices on legacy operating systems (OS).
- [Auto] Allows the system to detect the presence of USB devices at startup. If detected, the USB controller legacy mode is enabled. If no USB device is detected, the legacy USB support is disabled.

Legacy USB3.0 Support [Enabled]

- [Disabled] Disables the function.
- [Enabled] Enables the support for USB 3.0 devices on legacy operating systems (OS).

Intel xHCI Mode [Smart Auto]

- [Smart Auto] Keeps the last operation of xHCI controller in OS during boot up.
- [Auto] Enables the auto default.
- [Enabled] Enables the operation of xHCI controller.
- [Disabled] Disables the function.

EHCI Hand-off [Disabled]

- [Disabled] Disables the function.
- [Enabled] Enables the support for operating systems without an EHCI hand-off feature.

3.5.6 Onboard Devices Configuration

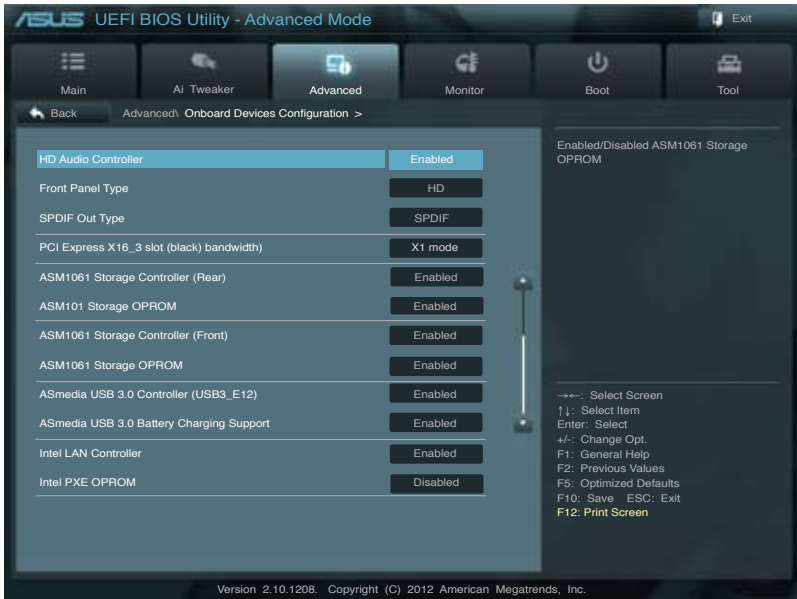

HD Audio Controller [Enabled]

- [Disabled] Disables the controller.
- [Enabled] Enables the High DUEFinition Audio Controller.



The following two items appear only when you set the **HD Audio Controller** item to [Enabled].

Front Panel Type [HD]

Allows you to set the front panel audio connector (AAFP) mode to legacy AC'97 or high-dUEFinition audio depending on the audio standard that the front panel audio module supports.

- [HD] Sets the front panel audio connector (AAFP) mode to high dUEFinition audio.
- [AC97] Sets the front panel audio connector (AAFP) mode to legacy AC'97

SPDIF Out Type [SPDIF]

- [SPDIF] Sets to [SPDIF] for SPDIF audio output.
- [HDMI] Sets to [HDMI] for HDMI audio output.

PCI Express X16_3 slot (black) [X1 mode]

Allows you to set the modes of the PCIe slots.

[X1 mode] PCIe x16_3 slot runs at X1 mode with all slots enabled.
[X4 mode] PCIe x16_3 slot runs at its highest performance support.



Enabling the X4 mode disables the PCIe x1_1, PCIe x1_2 and PCIe x1_3.

ASM1061 Storage Controller Front/Rear [Enable]

Allows you to enable or disable the ASM1061 storage controller.

Configuration options: [Disabled] [Enabled]

ASM1061 Storage OPROM Front/Rear [Enabled]

Allows you to enable or disable the OptionRom of the ASM1061 storage controller.

Configuration options: [Disabled] [Enabled]

Asmedia USB 3.0 Controller (USB3_E12) [Enabled]

This item allows you to enable or disable the Asmedia USB 3.0.

Configuration options: [Disabled] [Enabled]

Asmedia USB 3.0 Battery Charging Support [Disabled]

This item allows you to enable or disable Asmedia USB 3.0 battery charging support function.

Configuration options: [Disabled] [Enabled]

Intel LAN Controller [Enabled]

[Disabled] Disables the controller.

[Enabled] Enables the Intel LAN controller.

Intel PXE OPROM [Disabled]

This item appears only when you set the previous item to [Enabled] and allows you to enable or disable the PXE OptionRom of the Intel LAN controller.

Configuration options: [Enabled] [Disabled]

3.5.7 APM

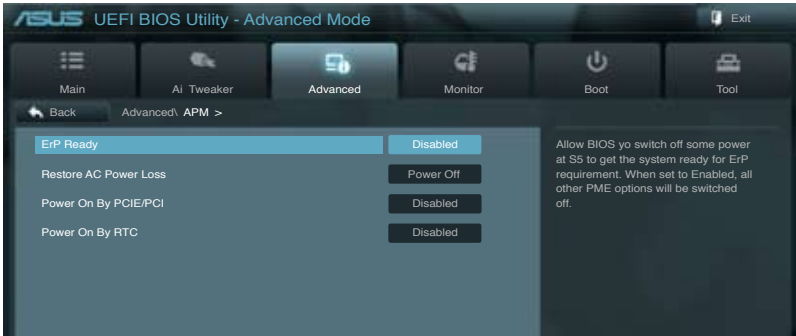

ErP Ready [Disabled]

This item allows user to switch off some power at S5 to get the system ready for ErP requirement. When set to Enabled, all other PME options will be switched off.
Configuration options: [Disabled] [Enabled]

Restore AC Power Loss [Power Off]

- [Power On] The system goes into on state after an AC power loss.
- [Power Off] The system goes into off state after an AC power loss.
- [Last State] The system goes into either off or on state, whatever the system state was before the AC power loss.

Power On By PCIE/PCI [Disabled]

- [Disabled] Disables the PCIE devices to generate a wake event.
- [Enabled] Enables the PCIE devices to generate a wake event.

Power On By RTC [Disabled]

- [Disabled] Disables RTC to generate a wake event.
- [Enabled] When set to [Enabled], the items **RTC Alarm Date (Days)** and **Hour/Minute/Second** becomes user-configurable with set values.

3.5.8 Network Stack

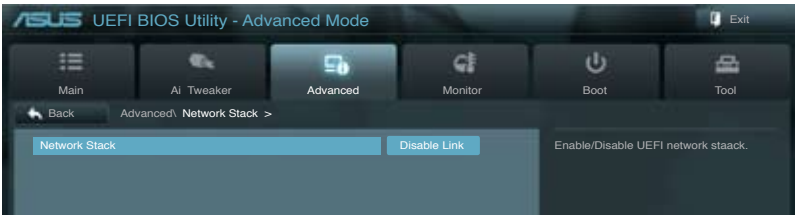

Network Stack [Disable Link]

This item allows user to disable or enable the UEFI network stack.

Configuration options: [Disable Link] [Enable]

Ipv4 PXE Support [Enable]

Configuration options: [Disable Link] [Enable]

Ipv6 PXE Support [Enable]

Configuration options: [Disable Link] [Enable]



The following items appear only when you set the **Network Stack** to [Enabled].

3.6 Monitor menu

The Monitor menu displays the system temperature/power status, and allows you to change the fan settings.



Scroll down to display the following items:

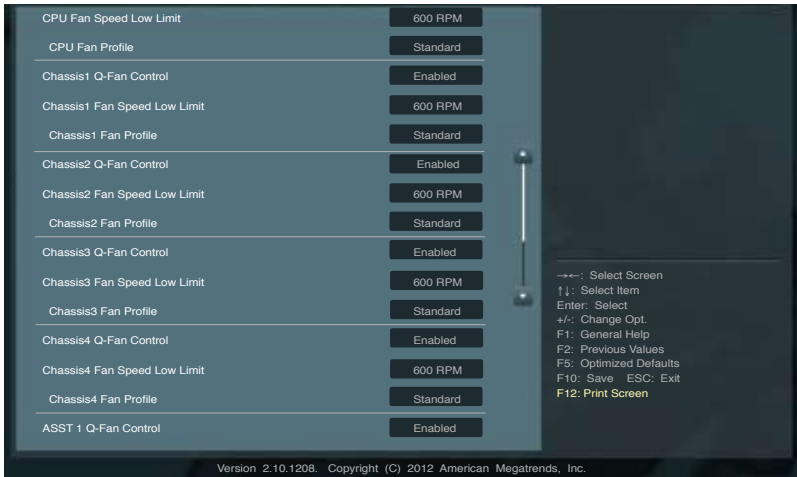

Scroll down to display the following items:



CPU Temperature / MB Temperature [xxx°C/xxx°F]

The onboard hardware monitor automatically detects and displays the CPU and motherboard temperatures. Select **Ignore** if you do not wish to display the detected temperatures.

CPU Fan Speed; CPU OPT Speed; Chassis Fan 1/2/3/4 Speed; Assistant Fan 1/2 Speed [xxxx RPM] or [Ignore] / [N/A]

The onboard hardware monitor automatically detects and displays the CPU fan, CPU OPT fan, chassis fan, and assistant fan speed in rotations per minute (RPM). If the fan is not connected to the motherboard, the field shows **N/A**. Select **Ignore** if you do not wish to display the detected speed.

CPU Voltage, 3.3V Voltage, 5V Voltage, 12V Voltage

The onboard hardware monitor automatically detects the voltage output through the onboard voltage regulators. Select **Ignore** if you do not want to detect this item.

CPU Q-Fan Control [Enabled]

[Disabled] Disables the CPU Q-Fan control feature.

[Enabled] Enables the CPU Q-Fan control feature.

CPU Fan Speed Low Limit [600 RPM]

This item appears only when you enable the **CPU Q-Fan Control** feature and allows you to disable or set the CPU fan warning speed.

Configuration options: [Ignore] [200 RPM] [300 RPM] [400 RPM] [500 RPM] [600 RPM]

CPU Fan Profile [Standard]

This item appears only when you enable the **CPU Q-Fan Control** feature and allows you to set the appropriate performance level of the CPU fan.

[Standard] Sets to [Standard] to make the CPU fan automatically adjust depending on the CPU temperature.

[Silent] Sets to [Silent] to minimize the fan speed for quiet CPU fan operation.

[Turbo] Sets to [Turbo] to achieve maximum CPU fan speed.

[Manual] Sets to [Manual] to assign detailed fan speed control parameters.



The following four items appear only when you set **CPU Fan Profile** to [Manual].

CPU Upper Temperature [70]

Use the <+> and <-> keys to adjust the upper limit of the CPU temperature. The values range from 20°C to 75°C.

CPU Fan Max. Duty Cycle(%) [100]

Use the <+> and <-> keys to adjust the maximum CPU fan duty cycle. The values range from 0% to 100%. The minimum value can not lower than the setting of Min duty cycle. When the CPU temperature reaches 75 degree, fan will run up to full speed.

CPU Lower Temperature [20]

Displays the lower limit of the CPU temperature.

CPU Fan Min. Duty Cycle(%) [20]

Use the <+> and <-> keys to adjust the minimum CPU fan duty cycle. The values range from 0% to 100%. When the CPU temperature is under 40°C, the CPU fan will operate at the minimum duty cycle.

Chassis 1/2/3/4 Q-Fan Control [Enabled]

[Disabled] Disables the Chassis Q-Fan control feature.

[Enabled] Enables the Chassis Q-Fan control feature.

Chassis 1/2/3/4 Fan Speed Low Limit [600 RPM]

This item appears only when you enable the **Chassis 1/2/3/4 Q-Fan Control** feature and allows you to disable or set the chassis fan warning speed.

Configuration options: [Ignore] [200 RPM] [300 RPM] [400 RPM] [500 RPM] [600 RPM]

Chassis 1/2/3/4 Fan Profile [Standard]

This item appears only when you enable the **Chassis Q-Fan Control** feature and allows you to set the appropriate performance level of the chassis fan.

[Standard] Sets to [Standard] to make the chassis fan automatically adjust depending on the chassis temperature.

[Silent] Sets to [Silent] to minimize the fan speed for quiet chassis fan operation.

[Turbo] Sets to [Turbo] to achieve maximum chassis fan speed.

[Manual] Sets to [Manual] to assign detailed fan speed control parameters.



The following four items appear only when you set **Chassis 1/2/3/4 Fan Profile** to [Manual].

Chassis 1/2/3/4 Upper Temperature [70]

Use the <+> and <-> keys to adjust the upper limit of the chassis temperature. The values range from 40°C to 90°C.

Chassis 1/2/3/4 Fan Max. Duty Cycle(%) [100]

Use the <+> and <-> keys to adjust the maximum chassis fan duty cycle. The values range from 60% to 100%. The minimum value can not lower than the setting of Min duty cycle. When the chassis temperature reaches 95 degree, fan will run up to full speed.

Chassis 1/2/3/4 Lower Temperature [40]

Displays the lower limit of the chassis temperature.

Chassis 1/2/3/4 Fan Min. Duty Cycle(%) [60]

Use the <+> and <-> keys to adjust the minimum chassis fan duty cycle. The values range from 60% to 100%. When the chassis temperature is under 40°C, the chassis fan will operate at the minimum duty cycle.

ASST 1/2 Q-Fan Control [Enabled]

[Disabled] Disables the Assistant Q-Fan control feature.

[Enabled] Enables the Assistant Q-Fan control feature.

Assistant 1/2 Fan Speed Low Limit [600 RPM]

This item appears only when you enable the **ASST 1/2 Q-Fan Control** feature and allows you to disable or set the chassis fan warning speed.

Configuration options: [Ignore] [200 RPM] [300 RPM] [400 RPM] [500 RPM] [600 RPM]

ASST 1/2 Fan Profile [Standard]

This item appears only when you enable the **ASST 1/2 Q-Fan Control** feature and allows you to set the appropriate performance level of the assistant fan.

[Standard] Sets to [Standard] to make the assistant fan automatically adjust depending on the assistant temperature.

[Silent] Sets to [Silent] to minimize the fan speed for quiet assistant fan operation.

[Turbo] Sets to [Turbo] to achieve maximum assistant fan speed.

[Manual] Sets to [Manual] to assign detailed fan speed control parameters.

[Fan-off] Sets to [Fan-off] to allow assistant fans to run at 0% duty cycle when the motherboard's temperature decreases to a certain degree.



The following four items appear only when you set **ASST 1/2 Fan Profile** to [Manual].

ASST 1/2 Upper Temperature [70]

Use the <+> and <-> keys to adjust the upper limit of the assistant/PCH temperature. The values range from 40°C to 90°C.

ASST 1/2 Fan Max. Duty Cycle(%) [100]

Use the <+> and <-> keys to adjust the maximum assistant/PCH fan duty cycle. The values range from 60% to 100%. The minimum value can not lower than the setting of Min duty cycle. When the assistant/PCH temperature reaches 95 degree, fan will run up to full speed.

ASST 1/2 Lower Temperature [40]

Displays the lower limit of the assistant/PCH temperature.

ASST 1/2 Fan Min. Duty Cycle(%) [60]

Use the <+> and <-> keys to adjust the minimum assistant/PCH fan duty cycle. The values range from 60% to 100%. When the assistant/PCH temperature is under 40°C, the assistant/PCH fan will operate at the minimum duty cycle.

Allow Fan Stop [Disable]

Allows your assistant fans to run at 0% cycle when the motherboard's temperature drops to a certain degree.

Configuration options: [Disable] [Enable]

Fan Overtime [1 minute]

Allows you to set the turbo fan's working time to extend for good heat dissipation, and lowers the temperature after system shutdown.

Configuration options: [Disable] [1 minute] [2 minutes] [3 minutes] [5 minutes] [10 minutes]

Anti Surge Support [Enabled]

This item allows you to enable or disable the Anti Surge function for UVP or OVP protection.

Configuration options: [Disabled] [Enabled]

3.7 Boot menu

The Boot menu items allow you to change the system boot options.

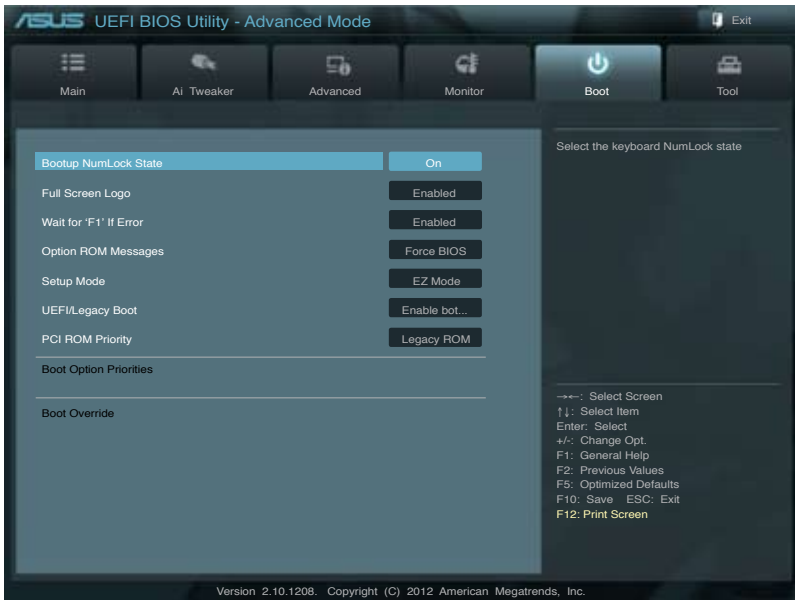

Bootup NumLock State [On]

[On] Sets the power-on state of the NumLock to [On].

[Off] Sets the power-on state of the NumLock to [Off].

Full Screen Logo [Enabled]

[Enabled] Enables the full screen logo display feature.

[Disabled] Disables the full screen logo display feature.



Set this item to [Enabled] to use the ASUS MyLogo 2™ feature.

Wait For 'F1' If Error [Enabled]

[Disabled] Disables this function.

[Enabled] The system waits for the <F1> key to be pressed when error occurs.

Option ROM Messages [Force BIOS]

[Force BIOS] The third-party ROM messages will be forced to display during the boot sequence.

[Keep Current] The third-party ROM messages will be displayed only if the third-party manufacturer had set the add-on device to do so.

Setup Mode [EZ Mode]

[Advanced Mode] Sets Advanced Mode as the default screen for entering the BIOS setup program.

[EZ Mode] Sets EZ Mode as the default screen for entering the BIOS setup program.

UEFI/Legacy Boot [Enable both UEFI and Legacy]

[Enable both UEFI and Legacy] Enables both UEFI and Legacy boot.

[Disable UEFI] Enables the Legacy boot, and disables the UEFI boot.

[Disable Legacy] Enables the UEFI boot, and disables the Legacy boot.

PCI ROM Priority [Legacy ROM]

Allows you launch a specific ROM option.

Configuration options: [Legacy ROM] [UEFI Compatible ROM]

Boot Option Priorities

These items specify the boot device priority sequence from the available devices. The number of device items that appears on the screen depends on the number of devices installed in the system.



-
- To select the boot device during system startup, press <F8> when ASUS Logo appears.
 - To access Windows OS in Safe Mode, press <F8> after POST.
-

Boot Override

These items displays the available devices. The number of device items that appears on the screen depends on the number of devices installed in the system. Click an item to start booting from the selected device.

3.8 Tool menu

The Tool menu items allow you to configure options for special functions. Select an item then press <Enter> to display the submenu.

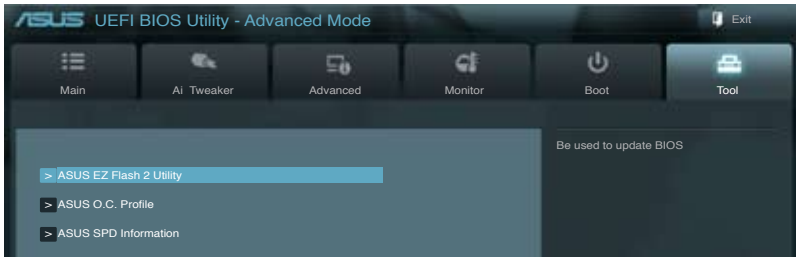

3.8.1 ASUS EZ Flash 2 Utility

Allows you to run ASUS EZ Flash 2 Utility. When you press <Enter>, a confirmation message appears. Use the left/right arrow key to select between [Yes] or [No], then press <Enter> to confirm your choice.



For more details, refer to **section 3.10.2 ASUS EZ Flash 2 utility**.

3.8.2. ASUS O.C. Profile

This item allows you to store or load multiple BIOS settings.

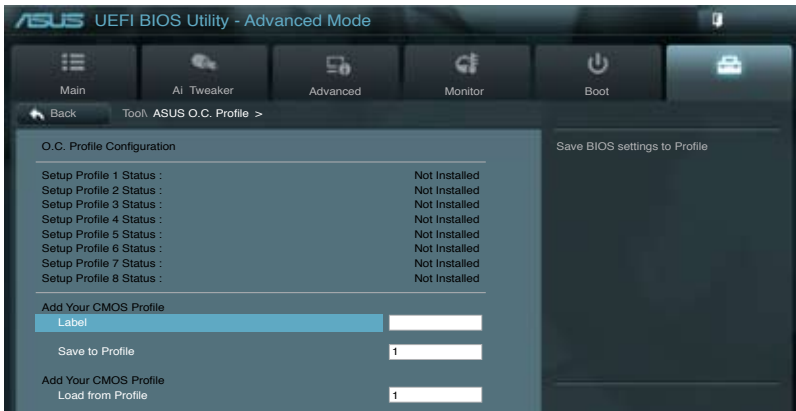

The **Setup Profile Status** items show **Not Installed** if no profile is created.

Label

Allows you to input the label of setup profile.

Save to Profile

Allows you to save the current BIOS settings to the BIOS Flash, and create a profile. Key in a profile number from one to eight, press <Enter>, and select **Yes**. You can also do this by or keying the <+> or <->, press <Enter> and select **Yes**.

Load from Profile

Allows you to load the previous BIOS settings saved in the BIOS Flash. Key in a profile number from one to eight, press <Enter>, and select **Yes**. You can also do this by or keying the <+> or <->, press <Enter> and select **Yes**.



- DO NOT shut down or reset the system while updating the BIOS to prevent the system boot failure!
- We recommend that you update the BIOS file only coming from the same memory/CPU configuration and BIOS version.

3.8.3. ASUS SPD Information

This item allows you to view the DRAM SPD information.

ASUS UEFI BIOS Utility - Advanced Mode

Main | AI Tweaker | Advanced | Monitor | Boot | Tool

Back | Tool\ ASUS SPD Information >

DIMM Slot # [DIMM_A2] | DIMM Slot number

Manufacturer: Samsung
Module Size: 1024 MBytes
Maximum Bandwidth: 1333 Mhz
Part Number: M391B2873DZ1-CH9
Serial Number: 060369f9
Product Week/Year: 50/2011
SPD Ext.

JEDEC ID

Frequency(Mhz)	1333	1600
Voltage (V)	1.500	1.650
CAS# Latency (tCL)	9	9
RAS# to CAS# (tRCD)	9	9
RAS# Precharge(tRP)	9	9
tRAS	24	27
tRC	33	36
tWR	10	12
tRRD	4	5
tRFC	74	88
tWTR	5	6
tRTP	5	6
tFAW	20	24

Navigation:
←→: Select Screen
↑↓: Select Item
Enter: Select
+/-: Change Opt.
F1: General Help
F2: Previous Values
F5: Optimized Defaults
F10: Save ESC: Exit
F12: Print Screen

Version 2.10.1208. Copyright (C) 2012 American Megatrends, Inc.

DIMM Slot # [DIMM_A2]

Allows you to view the information of the DIMM slots.
Configuration options: [Slot 1] [Slot 2] [Slot 3] [Slot 4]

3.9 Exit menu

The Exit menu items allow you to load the optimal default values for the BIOS items, and save or discard your changes to the BIOS items. You can access the **EZ Mode** from the Exit menu.

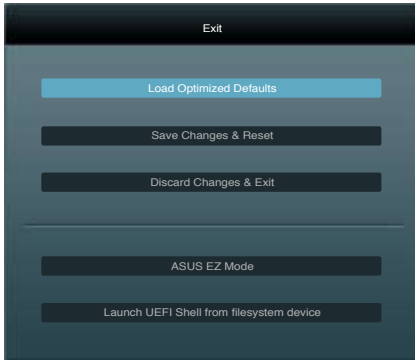

Load Optimized Defaults

This option allows you to load the default values for each of the parameters on the Setup menus. When you select this option or if you press <F5>, a confirmation window appears. Select **Yes** to load the default values.

Save Changes & Reset

Once you are finished making your selections, choose this option from the Exit menu to ensure the values you selected are saved. When you select this option or if you press <F10>, a confirmation window appears. Select **Yes** to save changes and exit.

Discard Changes & Exit

This option allows you to exit the Setup program without saving your changes. When you select this option or if you press <Esc>, a confirmation window appears. Select **Yes** to discard changes and exit.

ASUS EZ Mode

This option allows you to enter the EZ Mode screen.

Launch UEFI Shell from filesystem device

This option allows you to attempt to launch the UEFI Shell application (shellx64.UEFI) from one of the available filesystem devices.

3.10 Updating BIOS

The ASUS website publishes the latest BIOS versions to provide enhancements on system stability, compatibility, or performance. However, BIOS updating is potentially risky. If there is no problem using the current version of BIOS, **DO NOT manually update the BIOS**. Inappropriate BIOS updating may result in the system's failure to boot. Carefully follow the instructions of this chapter to update your BIOS if necessary.



Visit the ASUS website (www.asus.com) to download the latest BIOS file for this motherboard.

The following utilities allow you to manage and update the motherboard BIOS setup program.

1. **ASUS Update:** Updates the BIOS in Windows® environment.
2. **ASUS EZ Flash 2:** Updates the BIOS using a USB flash drive.
3. **ASUS CrashFree BIOS 3:** Restores the BIOS using the motherboard support DVD or a USB flash drive when the BIOS file fails or gets corrupted.
4. **ASUS BIOS Updater:** Updates and backups the BIOS in DOS environment using the motherboard support DVD and a USB flash disk drive.

Refer to the corresponding sections for details on these utilities.



Save a copy of the original motherboard BIOS file to a USB flash disk in case you need to restore the BIOS in the future. Copy the original motherboard BIOS using the **ASUS Update** or **BIOS Updater** utilities.

3.10.1 ASUS Update utility

The ASUS Update is a utility that allows you to manage, save, and update the motherboard BIOS in Windows® environment. The ASUS Update utility allows you to:

- Update the BIOS directly from the Internet
- Download the latest BIOS file from the Internet
- Update the BIOS from an updated BIOS file
- Save the current BIOS file
- View the BIOS version information

This utility is available in the support DVD that comes with the motherboard package.



ASUS Update requires an Internet connection either through a network or an Internet Service Provider (ISP).

Launching ASUS Update

After installing AI Suite II from the motherboard support DVD, launch ASUS Update by clicking **Update > ASUS Update** on the AI Suite II main menu bar.



Quit all Windows® applications before you update the BIOS using this utility.

Updating the BIOS through the Internet

To update the BIOS through the Internet:

1. From the ASUS Update screen, select **Update BIOS from Internet**, and then click **Next**.



2. Select the ASUS FTP site nearest you to avoid network traffic.

If you want to enable the BIOS downgradable function and auto BIOS backup function, check the checkboxes before the two items on the screen.



3. Select the BIOS version that you want to download. Click **Next**.



4. You can decide whether to change the BIOS boot logo, which is the image appearing on screen during the Power-On Self-Tests (POST). Click **Yes** if you want to change the boot logo or **No** to continue.
5. Follow the onscreen instructions to complete the update process.



Updating the BIOS through a BIOS file

To update the BIOS through a BIOS file:

1. From the ASUS Update screen, select **Update BIOS from file**, and then click **Next**.



2. Locate the BIOS file from the Open window, click **Open**, and click **Next**.



3. You can decide whether to change the BIOS boot logo. Click **Yes** if you want to change the boot logo or **No** to continue.
4. Follow the onscreen instructions to complete the update process.



- The screenshots in this section are for reference only. The actual BIOS information vary by models.
- Refer to the software manual in the support DVD or visit the ASUS website at www.asus.com for detailed software configuration.

3.10.2 ASUS EZ Flash 2 utility

The ASUS EZ Flash 2 feature allows you to update the BIOS without having to use a bootable floppy disk or an OS-based utility.



Before you start using this utility, download the latest BIOS from the ASUS website at www.asus.com.

To update the BIOS using EZ Flash 2:

1. Insert the USB flash disk that contains the latest BIOS file to the USB port.
2. Enter the Advanced Mode of the BIOS setup program. Go to the **Tool** menu to select **ASUS EZ Flash Utility** and press <Enter> to enable it.

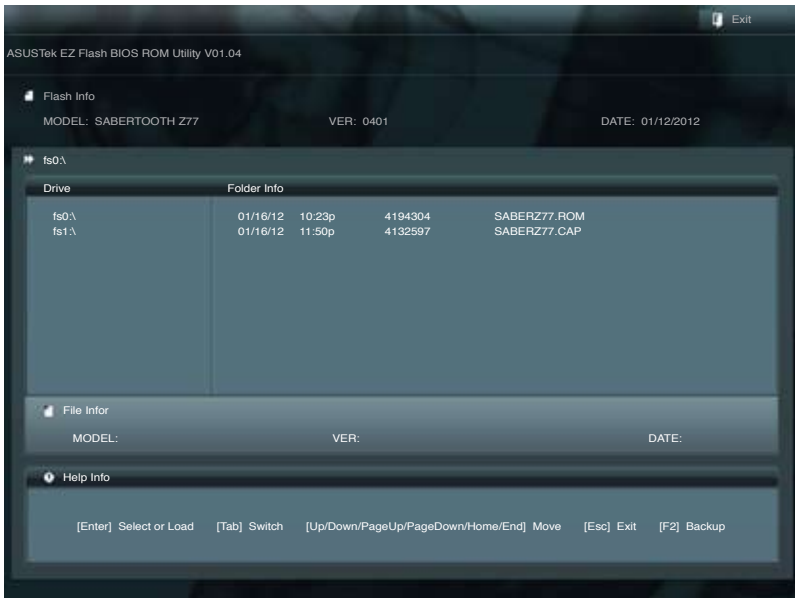

3. Press <Tab> to switch to the **Drive** field.
4. Press the Up/Down arrow keys to find the USB flash disk that contains the latest BIOS, and then press <Enter>.
5. Press <Tab> to switch to the **Folder Info** field.
6. Press the Up/Down arrow keys to find the BIOS file, and then press <Enter> to perform the BIOS update process. Reboot the system when the update process is done.



-
- This function can support devices such as a USB flash disk with FAT 32/16 format and single partition only.
 - DO NOT shut down or reset the system while updating the BIOS to prevent system boot failure!
-



Ensure to load the BIOS default settings to ensure system compatibility and stability. Select the **Load Optimized Defaults** item under the **Exit** menu. See section **3.9 Exit Menu** for details.

3.10.3 ASUS CrashFree BIOS 3 utility

The ASUS CrashFree BIOS 3 utility is an auto recovery tool that allows you to restore the BIOS file when it fails or gets corrupted during the updating process. You can restore a corrupted BIOS file using the motherboard support DVD or a USB flash drive that contains the BIOS file.



The BIOS file in the motherboard support DVD may be older than the BIOS file published on the ASUS official website. If you want to use the newer BIOS file, download the file at support.asus.com and save it to a USB flash drive.

Recovering the BIOS

To recover the BIOS:

1. Turn on the system.
2. Insert the motherboard support DVD to the optical drive, or the USB flash drive containing the BIOS file to the USB port.
3. The utility automatically checks the devices for the BIOS file. When found, the utility reads the BIOS file and enters ASUS EZ Flash 2 utility automatically.
4. The system requires you to enter BIOS Setup to recover BIOS setting. To ensure system compatibility and stability, we recommend that you press <F5> to load default BIOS values.



DO NOT shut down or reset the system while updating the BIOS! Doing so can cause system boot failure!

3.10.4 ASUS BIOS Updater

The ASUS BIOS Updater allows you to update BIOS in DOS environment. This utility also allows you to copy the current BIOS file that you can use as a backup when the BIOS fails or gets corrupted during the updating process.



The succeeding utility screens are for reference only. The actual utility screen displays may not be same as shown.

Before updating BIOS

1. Prepare the motherboard support DVD and a USB flash drive in FAT32/16 format and single partition.
2. Download the latest BIOS file and BIOS Updater from the ASUS website at <http://support.asus.com> and save them on the USB flash drive.



- NTFS is not supported under DOS environment. Do not save the BIOS file and BIOS Updater to a hard disk drive or USB flash drive in NTFS format.
- Do not save the BIOS file to a floppy disk due to low disk capacity.

3. Turn off the computer and disconnect all SATA hard disk drives (optional).

Booting the system in DOS environment

1. Insert the USB flash drive with the latest BIOS file and BIOS Updater to the USB port.
2. Boot your computer. When the ASUS Logo appears, press <F8> to show the **BIOS Boot Device Select Menu**. Insert the support DVD into the optical drive and select the optical drive as the boot device.

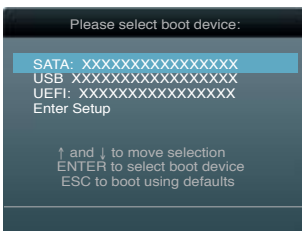

3. When the **Make Disk** menu appears, select the **FreeDOS command prompt** item by pressing the item number.
4. At the FreeDOS prompt, type **d:** and press <Enter> to switch the disk from Drive C (optical drive) to Drive D (USB flash drive).

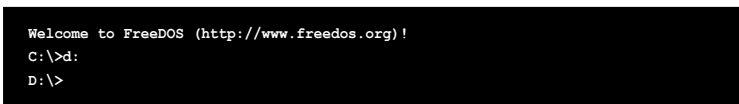

Backing up the current BIOS

To backup the current BIOS file using the BIOS Updater



Ensure that the USB flash drive is not write-protected and has enough free space to save the file.

1. At the FreeDOS prompt, type `bupdater /o[filename]` and press <Enter>.

```
D:\>bupdater /oOLDBIOS1 rom
```

Filename Extension

The [filename] is any user-assigned filename with no more than eight alphanumeric characters for the filename and three alphanumeric characters for the extension.

2. The BIOS Updater backup screen appears indicating the BIOS backup process. When BIOS backup is done, press any key to return to the DOS prompt.

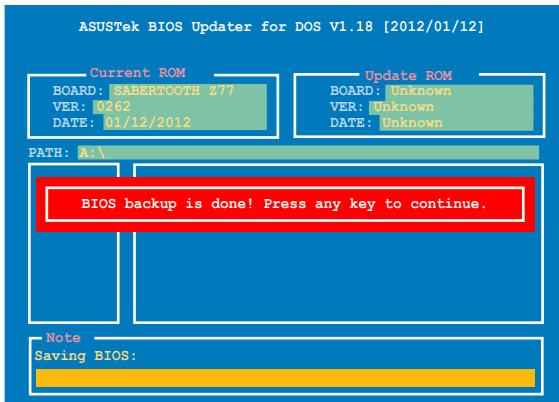

Updating the BIOS file

To update the BIOS file using BIOS Updater

1. At the FreeDOS prompt, type `bupdater /pc /g` and press <Enter>.

```
D:\>bupdater /pc /g
```

2. The BIOS Updater screen appears as below.

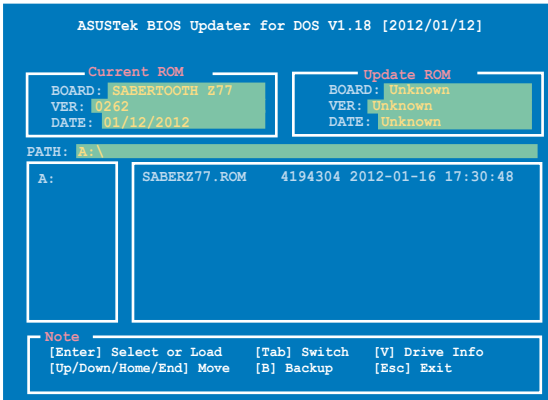

3. Press <Tab> to switch between screen fields and use the <Up/Down/Home/End> keys to select the BIOS file and press <Enter>. BIOS Updater checks the selected BIOS file and prompts you to confirm BIOS update.

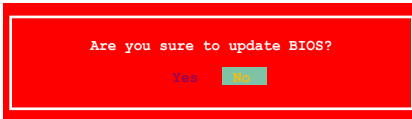

4. Select **Yes** and press <Enter>. When BIOS update is done, press <ESC> to exit BIOS Updater. Restart your computer.



DO NOT shut down or reset the system while updating the BIOS to prevent system boot failure!



- For BIOS Updater version 1.04 or later, the utility automatically exits to the DOS prompt after updating BIOS.
- Ensure to load the BIOS default settings to ensure system compatibility and stability. Select the **Load Optimized Defaults** item under the **Exit BIOS** menu. See Chapter 3 of your motherboard user manual for details.
- Ensure to connect all SATA hard disk drives after updating the BIOS file if you have disconnected them.

Chapter 4

4.1 Installing an operating system

This motherboard supports Windows® XP/ 64-bit XP/ 7 / 64-bit 7 operating systems (OS). Always install the latest OS version and corresponding updates to maximize the features of your hardware.



- Motherboard settings and hardware options vary. Use the setup procedures presented in this chapter for reference only. Refer to your OS documentation for detailed information.
- Ensure that you install the Windows® XP Service Pack 2 or later versions before installing the drivers for better compatibility and system stability.

4.2 Support DVD information

The support DVD that comes with the motherboard package contains the drivers, software applications, and utilities that you can install to avail all motherboard features.



The contents of the support DVD are subject to change at any time without notice. Visit the ASUS website at www.asus.com for updates.

4.2.1 Running the support DVD

Place the support DVD into the optical drive. The DVD automatically displays the Drivers menu if Autorun is enabled in your computer. Click each menu tab and select the items you want to install.

The Drivers menu shows the available device drivers if the system detects installed devices. Install the necessary drivers to use the devices.

The Make Disk menu contains items to create the RAID/AHCI driver disk.

The Manual menu contains the list of supplementary user manuals. Click an item to open the folder of the user manual.

The Utilities menu shows the applications and other software that the motherboard supports.

Click an item to install



Click the Contact tab to display the ASUS contact information.

Click an icon to display DVD/motherboard information



If Autorun is NOT enabled in your computer, browse the contents of the support DVD to locate the file ASSETUP.EXE from the BIN folder. Double-click the ASSETUP.EXE to run the DVD.

4.2.2 Obtaining the software manuals

The software manuals are included in the support DVD. Follow the instructions below to get the necessary software manuals.



The software manual files are in Portable Document Format (PDF). Install the Adobe® Acrobat® Reader from the Utilities menu before opening the files.

1. Click on the **Manual** tab. Click on **ASUS Motherboard Utility Guide** from the manual list on the left.



2. The **Manual** folder of the support DVD appears. Double-click the folder of your selected software.

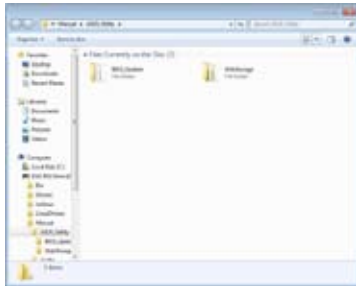

3. Some software manuals are provided in different languages. Double-click the language to show the software manual.

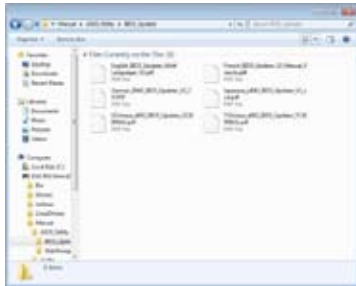

The screenshots in this section are for reference only. The actual software manuals containing in the support DVD vary by models.

4.3 Software information

Most of the applications in the support DVD have wizards that will conveniently guide you through the installation. View the online help or readme file that came with the software application for more information.

4.3.1 AI Suite II

AI Suite II is an all-in-one interface that integrates several ASUS utilities and allows users to launch and operate these utilities simultaneously.

Installing AI Suite II

To install AI Suite II on your computer

1. Place the support DVD to the optical drive. The Drivers installation tab appears if your computer has enabled the Autorun feature.
2. Click the Utilities tab, then click **AI Suite II**.
3. Follow the onscreen instructions to complete installation.

Using AI Suite II

AI Suite II automatically starts when you enter the Windows® operating system (OS). The AI Suite II icon appears in the Windows® notification area. Click the icon to open the AI Suite II main menu bar.

Click each button to select and launch a utility, to monitor the system, to update the motherboard BIOS, to display the system information, and to customize the settings of AI Suite II.

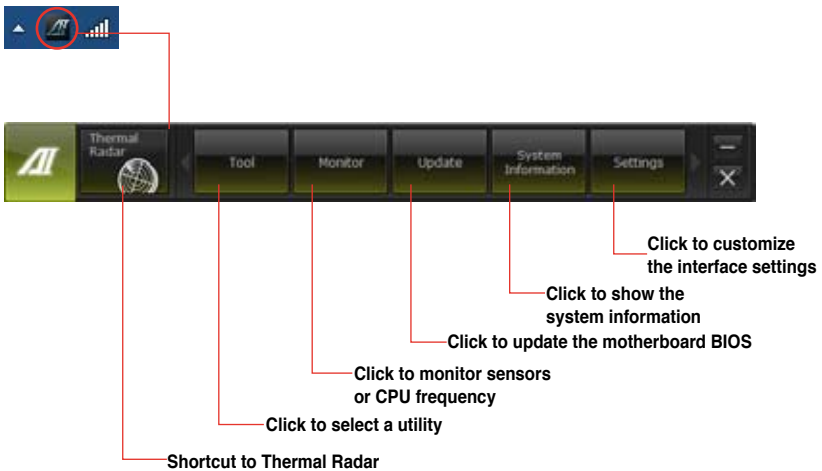

- The applications in the Tool menu vary with models.
- The screenshots of AI Suite II in this user manual are for reference only. The actual screenshots vary with models.
- Refer to the software manual in the support DVD or visit the ASUS website at www.asus.com for detailed software configuration.

4.3.2 ASUS TUF Thermal Radar

The TUF Thermal Radar monitors temperatures in critical parts of the motherboard in real time, automatically adjusting fan speeds to make sure the system maintains high stability without overheating. It consists of multiple sensors for various components on the motherboard, giving user the ability to monitor each one individually. The Thermal Radar automatically calculates ideal fan speeds based on different parameters selected by users for each component, keeping everything cooler and longer lasting.

Launching Thermal Radar

After installing AI Suite II from the motherboard support DVD, launch Thermal Radar by clicking the **Thermal Radar** icon on the AI Suite II main menu bar.



The software screen captures in this manual are for reference only, but the operation steps remain the same.

Using the Thermal Radar main screen

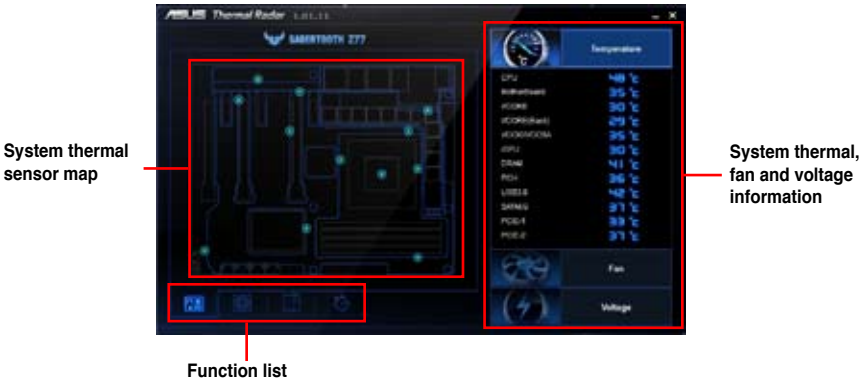



- Click any thermal sensor on the sensor map to read the detail information of the selected sensor.
- On the right part of the Thermal Radar main screen, click **Temperature**, **Fan** or **Voltage** to see the real-time system thermal, fan and voltage information.

Configuring system fan settings

The TUF Thermal Radar provides easy-to-use fan profiles for adjusting the CPU fan, assistant fan (I/O cover fan and cover fan), and the chassis fan speeds according to different ambient temperatures caused by different climate conditions in different geographic regions and your PC's system loading. Thermal Radar also provides fully-customizable fan speed control, offering the most flexible controls of fan speed to achieve a quiet and cool environment.

Loading default fan profiles

To load the system default fan profiles

1. Click  or  from the function list on the bottom of the Thermal Radar main screen.
2. Click a fan to configure. For example, click CPU Fan.



3. Read the introduction and notice of the selected fan. Click **Setting**.



4. Select a fan profile in the **Profile Name** drop-down list and click **Apply**. You can also configure other system fans by clicking the **CHA** and **ASST** icon below.



Configuring user-customizable fan settings

You can customize the fan speed to meet different computing and environment needs.

To fast customize the fan speed

1. Select **User** in the **Profile Name** drop-down list.
2. Drag the control points on the fan speed curve to set the fan speed percentage.
3. Click **Apply**.



You can also assign the specific system component(s) to monitor and have Thermal Radar to dynamically adjust the fan speeds in real-time when the temperature of the monitored system component reaches to certain degree.

To customize the fan speed with advanced options

1. Select **User** in the **Profile Name** drop-down list.
2. Drag the paper clip icon to the system component(s) listed on the right of the Thermal Radar window. You can assign maximum three components to monitor.



3. Adjust the slider(s) under each component you selected for a combination of 100% and click **Apply**.

For example, you assign 60% to motherboard, 20% to VCORE, and 20% to VCCSA and click **Apply**, Thermal Radar automatically sets the required fan speed by calculating the overall temperature of the monitored components.



- If you are not sure how to choose the proper components to monitor and the percentage to adjust, click **Auto** and have Thermal Radar do the recommended settings for you. Click **Apply** for the setting to take effect.



Configuring Fan-Off settings

When this function is selected, the fans automatically turn off when the temperature drops to a certain level and run when the system's temperature rises.

To enable or disable the assistant fans:

- Click  and select the fan from the **Fan Name** drop-down list.
- Select **Fan-Off** in the **Profile name** dropdown list.
- Click **Apply**.



You can also tick **Allow Fan Stop** to enable the Fan-off setting under the **User** profile.



Configuring Fan Overtime settings

Allows you to customize the fan's working time to dissipate the remaining heat after shutting down or in standby mode.

To fast customize the fan overtime:

1. Click .
2. Drag the scroll bar on the Fan Overtime screen.
3. Click **Apply**. Click **Undo** to cancel the fan overtime settings made.



- Maximum fan overtime is 10 minutes.
- Default fan overtime is 1 minute.
- Fan Overtime is only applicable for two assistant fans.



- Fan Overtime is disabled when you enable the ErP in the BIOS.
- The two assistant (ASST) fans run on standby power after system shutdown. DO NOT connect too many standby-powered devices as this result to power overload.

4.3.3 TurboV EVO

ASUS TurboV EVO introduces **TurboV** that allows you to manually adjust the CPU frequency and related voltage values. After installing AI Suite II from the motherboard support DVD, launch TurboV EVO by clicking **Tool > TurboV EVO** on the AI Suite II main menu bar.



Refer to the software manual in the support DVD or visit the ASUS website at www.asus.com for detailed software configuration.

TurboV

TurboV allows you to overclock the BCLK frequency, CPU voltage, IMC voltage, and DRAM Bus voltage in Windows® environment and takes effect in real-time without exiting and rebooting the OS.



Refer to the CPU documentation before adjusting CPU voltage settings. Setting a high voltage may damage the CPU permanently, and setting a low voltage may make the system unstable.



For system stability, all changes made in TurboV will not be saved to BIOS settings and will not be kept on the next system boot. Use the **Save Profile** function to save your customized overclocking settings and manually load the profile after Windows starts.

Load profile

Target values

Current values

Click to show settings

Click to restore all start-up settings

Save the current settings as a new profile

Voltage Adjustment bars

Undoes all changes without applying

Applies all changes immediately

Using Advanced Mode

Click on the **Advanced Mode** tab to adjust the advanced voltage settings.

The screenshot shows the TurboV EVO interface in Advanced Mode. On the left, there are 'Advanced Mode' and 'CPU Ratio' tabs. Below them is a table of current values for BIOS Frequency, CPU PLL Voltage, FCH Voltage, QM-DIMM, QM-DIMM2, and QM-DIMM3. The main area contains several sliders for target values, with red boxes highlighting the 'Voltage Adjustment bars' and a 'Click to restore all start-up settings' button. On the right, a 'CPU' panel shows the current CPU Frequency at 1604.8 MHz and CPU Usage at 7%.

Advanced mode
Target values
Current values
Click to restore all start-up settings
Voltage Adjustment bars
Undoes all changes without applying
Applies all changes immediately

CPU Ratio

Allows you to manually adjust the CPU ratio.

1. Click the **CPU Ratio** tab.
2. Click **ON** to activate the CPU Ratio function. The system automatically reboots for the changes to take effect.
3. After system reboot, launch TurboV EVO again, and then click the CPU Ratio tab. Drag the adjustment bar upwards or downwards to the desired value.
4. Click **Apply** to make the change take effect.

The screenshot shows the TurboV EVO interface in CPU Ratio mode. The 'CPU Ratio' tab is selected. A large 'Ratio' adjustment bar is visible, with a red box highlighting it. Below the bar are 'ON' and 'OFF' buttons and an 'Apply' button. A 'Click to restore all start-up settings' button is also present. The background shows the same voltage and frequency settings as the previous screenshot.

CPU Ratio
Adjustment bar
Click to restore all start-up settings
Undoes all changes without applying
Applies all changes immediately



- Set the **CPU Ratio Setting** item in BIOS to [Auto] before using the CPU Ratio function in TurboV. Refer to Chapter 3 of your motherboard user manual for details.
- The CPU Ratio bars show the status of the CPU cores, which vary with your CPU model.

4.3.4 DIGI+ Power Control

DIGI+ PowerControl allows you to adjust VRM voltage and frequency modulation to enhance reliability and stability. It also provides the highest power efficiency, generating less heat to longer component lifespan and minimize power loss.

After installing AI Suite II from the motherboard support DVD, launch DIGI+ Power Control by clicking **Tool > DIGI+ Power Control** on the AI Suite II main menu bar.

Select **CPU Power** or **DRAM Power** to adjust the power control settings.

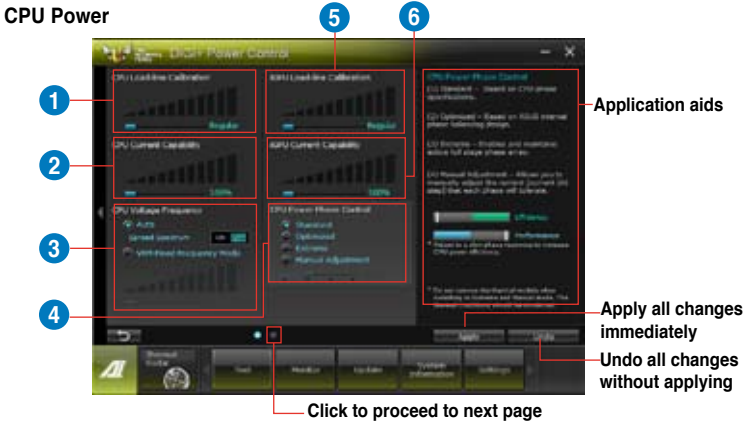

Function no.	Function description
1	CPU Load-line Calibration It allows you to adjust the voltage settings and control the system temperature. Higher load-line calibration could get higher voltage and good overclocking performance but increases the CPU and VRM thermal.
2	CPU Current Capability CPU Current Capability provides wider total power range for overclocking. A higher value setting gets higher VRM power consumption delivery.
3	CPU Voltage Frequency Switching frequency will affect the VRM transient response and component thermal. Higher frequency gets quicker transient response.
4	CPU Power Phase Control Increase phase number under heavy system loading to get more transient and better thermal performance. Reduce phase number under light system loading to increase VRM efficiency.
5	iGPU Load line Calibration Load-line is defined by Intel VRM specifications and affects the iGPU voltage. The iGPU working voltage decreases proportionally to integrated graphics loading. A higher value can get a higher iGPU voltage and a good performance, but decreases the CPU and VRM thermal conditions.
6	iGPU Current Capability A higher value brings wider total iGPU power range and extends the overclocking frequency range simultaneously to enhance the iGPU performance.

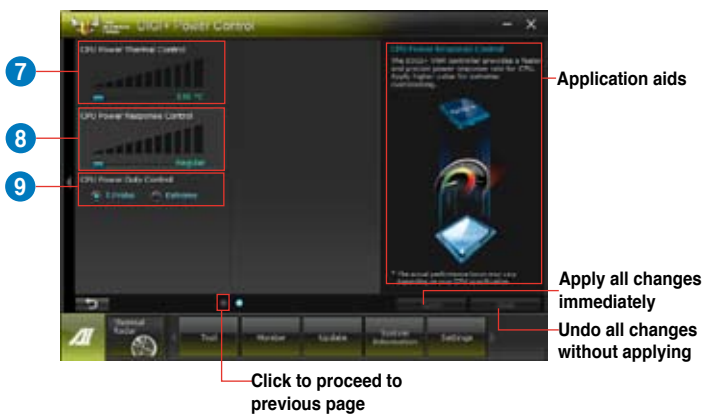

Function no.	Function description
7	CPU Power Thermal Control A higher temperature brings a wider CPU power thermal range and extends the overclocking performance to enlarge O.C potential.
8	CPU Power Response Control Provides a faster and precise power response rate for your CPU. Apply a higher value for extreme overclocking.
9	CPU Power Duty Control Balances the load on the power phases based on the current system load or phase bank temperature.

DRAM Power

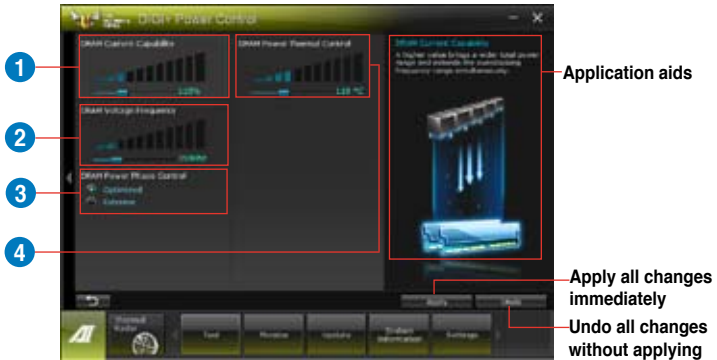

Function no.	Function description
1	DRAM Current Capability A higher value brings a wider total power range and extends the overlocking frequency range simultaneously.
2	DRAM Voltage Frequency Allows you to adjust the DRAM switching frequency for system stability or to increase OC Range.
3	DRAM Power Phase Control Set Manual Adjustment to faster phase response to increase system performance or to slower phase response to increase DRAM power efficiency.
4	DRAM Power Thermal Control Allows you to set a wider DRAM power thermal range, and extends the overlocking tolerance to widen O.C potential.



- The actual performance boost may vary depending on your CPU and DRAM specification.
- Do not remove the thermal module. The thermal conditions should be monitored.

Smart DIGI+



Function no.	Function description
1	35W Allows you to limit the wattage to 35W for power saving.
2	45W Allows you to limit the wattage to 45W for power saving.



Setting a specific wattage decreases the total power delivery to the CPU, and affects the system's performance under a heavy system load.



- The actual performance boost may vary depending on your CPU and DRAM specification.
- Do not remove the thermal module. The thermal conditions should be monitored.

4.3.6 Ai Charger+

This utility allows you to fast-charge your portable BC 1.1* mobile devices on your computer's USB port three times faster than the standard USB devices**.



- *Check your USB device manufacturer if it fully supports the BC 1.1 function.
- **The actual charging speed may vary with your USB device's conditions.

To launch Ai Charger+, click, **Tool > Ai Charger+** on the AI Suite II main menu bar.



4.3.7 USB Charger+

This utility allows you to fast-charge your portable USB devices even if your PC is off, in Sleep Mode, or Hibernate Mode.

Launching the USB Charger+

To launch this utility, open the **AI Suite II**, then click **Tool > USB Charger+**.



* The illustration above shows that no device connected to your PC for fast-charging.

USB fast-charging mode settings

Click the dropdown box, and select a proper charge mode when your PC is off, in Sleep Mode, or Hibernate Mode.

- **Disable:** disables the USB fast-charging function.
- **ASUS:** fast-charges your connected ASUS devices.
- **Apple:** fast-charges your connected Apple devices.
- **Kindle:** fast-charges your Kindle devices.
- **Others:** charges other portable USB devices.



The utility cannot detect the devices connected to your computer if the charging mode is enabled.

Setting up the charging function

When a portable device is connected to the USB port of the PC, the USB Charger+ automatically detects the kind of your device.

Charging the device

Click  to fast-charge your device.

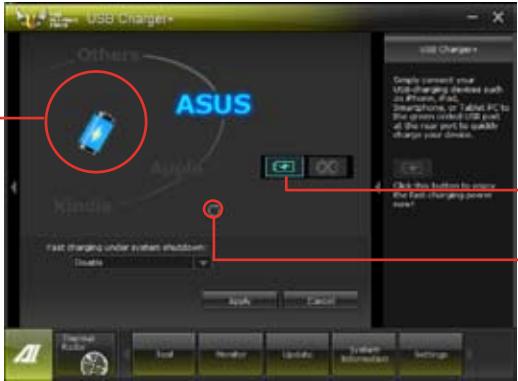

Indicates that the portable device is in charging mode



Click to fast-charge your connected device.

Click to rescan the connected device.



Clicking the  stops the charging of your connected device, and rescans for other detected devices. Click the  to re-enable the fast-charging.

Disabling the charging function

Click  to stop charging your device.

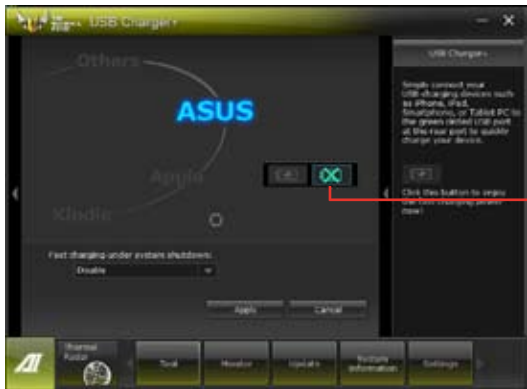

Click to stop fast-charging the connected device.

4.3.8 USB 3.0 Boost

The ASUS exclusive USB 3.0 Boost provides speed boost for USB 3.0 devices and the up-to-date support of USB Attached SCSI Protocol (UASP). With USB 3.0 Boost, you can accelerate the transfer speed of your USB 3.0 devices with ease.

Launching USB 3.0 Boost

After installing AI Suite II from the motherboard support DVD, launch USB 3.0 Boost by clicking **Tool > USB 3.0 Boost** on the AI Suite II main menu bar.

Configuring USB 3.0 Boost

1. Connect a USB 3.0 device to the USB 3.0 port.
2. USB 3.0 Boost automatically detects the property of the connected device and switches to **Turbo** mode or **UASP** mode (if UASP is supported by the connected device).
3. You can manually switch the USB 3.0 mode back to **Normal** mode at any time.



Refer to the software manual in the support DVD or visit the ASUS website at www.asus.com for detailed software configuration.

4.3.9 Network iControl

ASUS Network iControl, a one-stop setup network control center that gives you the EZ Start, Quick Connection, and EZ Profile functions, makes it easier for you to manage your network bandwidth. It also allows you to automatically connect to a PPPoE network for a more convenient online experience.

To launch Network iControl, click **Tool > Network iControl** from AI Suite II main menu bar.



- Ensure to install the LAN drivers before using this function.
- Network iControl is only supported under Windows 7 and can only support the onboard LAN.

Using EZ Start

EZ Start allows you to quickly activate Network iControl, and set the highest bandwidth priority for your top currently running program.

To use EZ Start:

1. Click the EZ Start tab.
2. Click **ON/OFF** to enable/disable Network iControl.



- By default, Network iControl is set to **ON**.
- When switched off, the **Quick Connection**, **EZ Profile** and **Info** are disabled.
- You may monitor the bandwidth priority from your desktop's taskbar.

3. Tick **Set current network program as the highest priority** to enable **User Profile**.
4. Select a profile and click **Apply**.



You may also apply your personal profile in **EZ Start**.

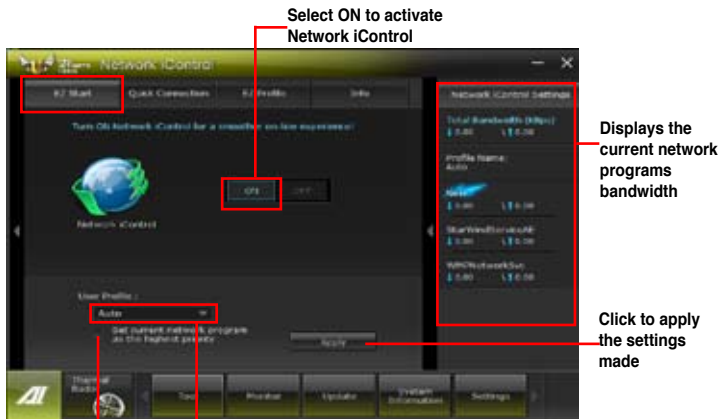

Click to enable the network program as the highest priority

Click to select a profile

Using Quick Connection

Configuring the PPPoE connection settings

Before enabling the Network iControl's **Quick Connection** functions, you must configure the PPPoE connection settings

To configure the PPPoE settings:

1. Right-click  in the taskbar, and select **Open Network and Sharing Center**.

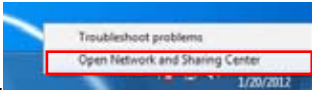

2. Right-click the PPPoE Connection, and select **Properties**.

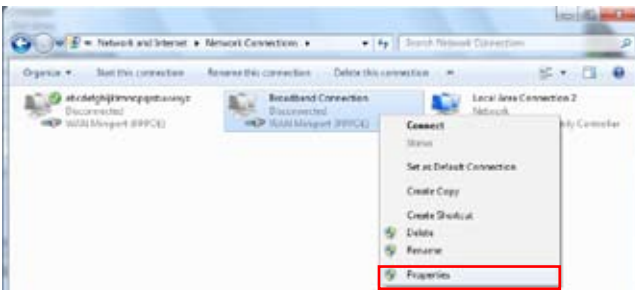

3. Click the **Options** tab, and deselect **Prompt for name and password, certificate, etc.** Click **OK** to complete the auto PPPoE connection settings.

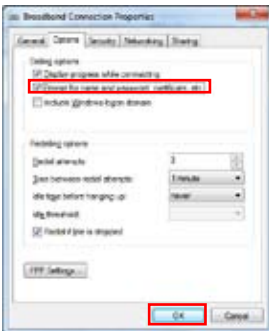

- You only need to configure the PPPoE connection settings once.
- Obtain the necessary information about your PPPoE connection from your network provider.

Configuring the Quick Connection

To configure the auto-PPPoE connection:

1. Click the **Quick Connection** tab.
2. Tick **Automatically connect online anytime** option, then select the connection name in the **Connection Name** dropdown box.
3. Click **Apply** to enable PPPoE automatic network connection.



You can also enable the **No Delay TCP** function to help improve the network performance.

Click to select
Connection Name

Click to set
the auto
PPPoE
connection





Click to apply
settings

Click ON
to improve
network
performance

Using EZ Profile

To use the EZ Profile:

EZ Profile allows you to load, edit, and save your own network program priority profile.

1. Click the **EZ Profile** tab. The programs are shown in the network program column.
2. Select the network program, and click  to create your profile.
3. Click  to save the changes and/or rename your profile.
4. Click , , or  to set the program priority as High, Normal, or Low.

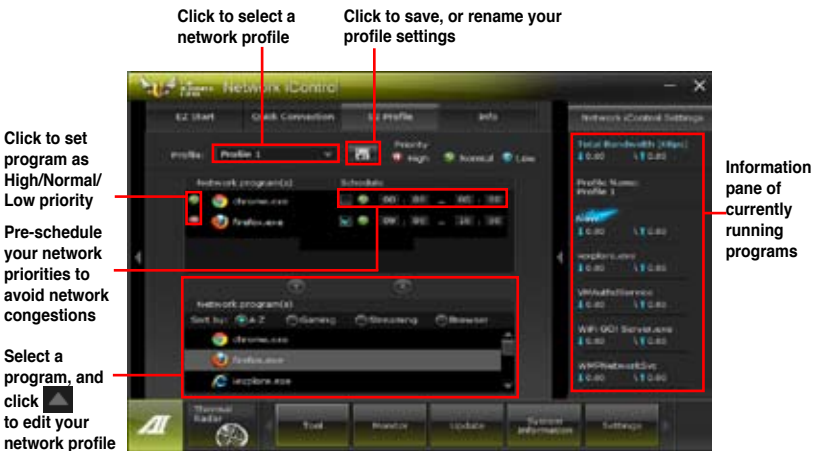

4.3.10 ASUS Update

ASUS Update lays out the options for updating BIOS on your system. Update BIOS utility on your system or simply save the utility for later use just by following the directions on this convenient updating feature.

Launching ASUS Update

After installing AI Suite II from the motherboard support DVD, launch ASUS Update by clicking **Update> ASUS Update** on the AI Suite II main menu bar.

Using ASUS Update

Select the way you would like to do with the BIOS utility. Click on **Next** and follow the instructions to complete your request.



- **Update BIOS from Internet**
Download the latest BIOS utility from the ASUS service website (www.asus.com) and follow the suggested procedures to update the BIOS version on your system.
- **Download BIOS from Internet**
Download the latest BIOS utility from the ASUS service website (www.asus.com) and save for later use.
- **Update BIOS from file**
Use the BIOS utility demanded from a source file to update the BIOS version on your system.
- **Save BIOS to file**
Back up the current BIOS utility on your system to another file or USB disk to save for later use.



There may be risks of system crash when updating BIOS. Backing up the original BIOS utility is recommended before updating.

2. Click on **Auto Tune** to adjust image size compatibility or adjust the resolution bar.
3. You can click on Booting Preview to preview the boot image. Then click Next.
4. Click on Flash to start updating the image to the boot logo.
5. Click on Yes to reboot or you can also see the new logo next time you restart your computer.



Change the boot logo of a downloaded BIOS file and update (or do not update) this BIOS to the motherboard

1. At BIOS File, **Browse** to download the requested BIOS file to your system. This utility will help you detect the compatibility of the BIOS version.
2. Then at Picture File, Browse to select the desired image for boot logo. Click Next.
3. Follow steps 2-5 in **Change the BIOS boot logo of my motherboard** to complete logo update.



The fullscreen logo application in BIOS utility must be enabled for MyLogo to take effect.

4.3.12 Audio configurations

The Realtek® audio CODEC provides 8-channel audio capability to deliver the ultimate audio experience on your computer. The software provides Jack-Detection function, S/PDIF Out support, and interrupt capability. The CODEC also includes the Realtek® proprietary UAJ® (Universal Audio Jack) technology for all audio ports, eliminating cable connection errors and giving users plug and play convenience.

Follow the installation wizard to install the Realtek® Audio Driver from the support DVD that came with the motherboard package.

If the Realtek audio software is correctly installed, you will find the **Realtek HD Audio Manager** icon on the taskbar. Double-click on the icon to display the Realtek HD Audio Manager.



Realtek HD Audio Manager

A. Realtek HD Audio Manager for Windows® 7™

Configuration option tabs (vary with the audio devices connected)



B. Realtek HD Audio Manager for Windows XP



- Refer to the software manual in the support DVD or visit the ASUS website at www.asus.com for detailed software configuration.
- Due to Intel® Z77 platform does not support Windows® Vista™, Realtek HD Audio driver is only supported by Windows® 7™ /Windows® XP™.
- To play Blu-ray disc, ensure to use an HDCP compliant monitor.

4.4 RAID configurations

The motherboard comes with the Intel® Z77 chipset controller that allows you to configure Serial ATA hard disk drives as RAID sets. The motherboard supports the following RAID configurations:

- **Intel® Rapid Storage Technology** with RAID 0, RAID 1, RAID 10 and RAID 5 support.



- You must install Windows® XP Service Pack 3 or later versions before using Serial ATA hard disk drives. The Serial ATA RAID feature is available only if you are using Windows® XP Service Pack 3 or later versions.
- Due to Windows® XP limitation, a RAID array with the total capacity over 2TB cannot be set as a boot disk. A RAID array over 2TB can only be set as a data disk only.
- If you want to install a Windows® operating system to a hard disk drive included in a RAID set, you have to create a RAID driver disk and load the RAID driver during OS installation. Refer to section 4.5 **Creating a RAID driver disk** for details.

4.4.1 RAID definitions

RAID 0 (Data striping) optimizes two identical hard disk drives to read and write data in parallel, interleaved stacks. Two hard disks perform the same work as a single drive but at a sustained data transfer rate, double that of a single disk alone, thus improving data access and storage. Use of two new identical hard disk drives is required for this setup.

RAID 1 (Data mirroring) copies and maintains an identical image of data from one drive to a second drive. If one drive fails, the disk array management software directs all applications to the surviving drive as it contains a complete copy of the data in the other drive. This RAID configuration provides data protection and increases fault tolerance to the entire system. Use two new drives or use an existing drive and a new drive for this setup. The new drive must be of the same size or larger than the existing drive.

RAID 5 stripes both data and parity information across three or more hard disk drives. Among the advantages of RAID 5 configuration include better HDD performance, fault tolerance, and higher storage capacity. The RAID 5 configuration is best suited for transaction processing, relational database applications, enterprise resource planning, and other business systems. Use a minimum of three identical hard disk drives for this setup.

RAID 10 is data striping and data mirroring combined without parity (redundancy data) having to be calculated and written. With the RAID 10 configuration you get all the benefits of both RAID 0 and RAID 1 configurations. Use four new hard disk drives or use an existing drive and three new drives for this setup.

4.4.2 Installing Serial ATA hard disks

The motherboard supports Serial ATA hard disk drives. For optimal performance, install identical drives of the same model and capacity when creating a disk array.

To install the SATA hard disks for a RAID configuration:

1. Install the SATA hard disks into the drive bays.
2. Connect the SATA signal cables.
3. Connect a SATA power cable to the power connector on each drive.

4.4.3 Setting the RAID item in BIOS

You must enable the RAID function in the BIOS Setup before creating RAID set(s) using SATA HDDs. To do this:

1. Enter the BIOS Setup during POST.
2. Go to the **Advanced** menu > **SATA Configuration**, and then press <Enter>.
3. Set the **SATA Mode** item to [RAID Mode].
4. Save your changes, and then exit the BIOS Setup.



Refer to Chapter 3 for details on entering and navigating through the BIOS Setup.



Due to chipset limitation, when set any of SATA ports to RAID mode, all SATA ports run at RAID mode together.

4.4.4 Intel® Rapid Storage Technology Option ROM utility

To enter the Intel® Rapid Storage Technology Option ROM utility:

1. Turn on the system.
2. During POST, press <Ctrl> + <I> to display the utility main menu.

```
Intel(R) Rapid Storage Technology - Option ROM - v10.0.0.1032
Copyright(C) 2003-10 Intel Corporation. All Rights Reserved.

[ MAIN MENU ]
1. Create RAID Volume
2. Delete RAID Volume
3. Reset Disks to Non-RAID
4. Recovery Volume Options
5. Exit

[ DISK/VOLUME INFORMATION ]

RAID Volumes:
None defined.

Physical Devices:
Port Device Model Serial # Size Type/Status (Vol ID)
0 ST3160812AS 9LS0HJA4 149.0GB Non-RAID Disk
1 ST3160812AS 9LS0F4HL 149.0GB Non-RAID Disk
2 ST3160812AS 3LS0JYL8 149.0GB Non-RAID Disk
3 ST3160812AS 9LS0B75H 149.0GB Non-RAID Disk

[↑↓]-Select [ESC]-Exit [ENTER]-Select Menu
```

The navigation keys at the bottom of the screen allow you to move through the menus and select the menu options.



The RAID BIOS setup screens shown in this section are for reference only and may not exactly match the items on your screen.



The utility supports maximum four hard disk drives for RAID configuration.

Creating a RAID set

To create a RAID set:

1. From the utility main menu, select **1. Create RAID Volume** and press <Enter>. The following screen appears:

```
Intel(R) Rapid Storage Technology - Option ROM - v10.0.0.1032
Copyright(C) 2003-10 Intel Corporation. All Rights Reserved.

-----[ CREATE VOLUME MENU ]-----
Name: Volume0
RAID Level: RAID0(Stripe)
Disks: Select Disks
Strip Size: 128KB
Capacity: 0.0 GB
Sync: N/A
Create Volume

-----[ HELP ]-----

Enter a unique volume name that has no special characters and is
16 characters or less.

[↑↓]-Change [TAB]-Next [ESC]-Previous Menu [ENTER]-Select
```

2. Enter a name for the RAID set and press <Enter>.
3. When the **RAID Level** item is selected, press the up/down arrow key to select a RAID level to create, and then press <Enter>.
4. When the **Disks** item is selected, press <Enter> to select the hard disk drives you want to include in the RAID set. The **SELECT DISKS** screen appears:

```
-----[ SELECT DISKS ]-----
Port Drive Model Serial # Size Status
0 SW16031P2AS 9LS0BJ4Y 149.0GB Non-RAID Disk
1 ST3160812AS 9LS0F4HL 149.0GB Non-RAID Disk
2 ST3160812AS 3LS0JYL8 149.0GB Non-RAID Disk
3 ST3160812AS 9LS0BJ5H 149.0GB Non-RAID Disk

Select 2 to 6 disks to use in creating the volume.

[↑↓]-Prev/Next [SPACE]-SelectDisk [ENTER]-Done
```

5. Use the up/down arrow key to select a drive, and then press <Space> to select. A small triangle marks the selected drive. Press <Enter> after completing your selection.
6. Use the up/down arrow key to select the stripe size for the RAID array (for RAID 0, 10 and 5 only), and then press <Enter>. The available stripe size values range from 4KB to 128KB. The following are typical values:
RAID 0: 128KB
RAID 10: 64KB
RAID 5: 64KB



We recommend a lower stripe size for server systems, and a higher stripe size for multimedia computer systems used mainly for audio and video editing.

7. When the **Capacity** item is selected, enter the RAID volume capacity that you want and press <Enter>. The default value indicates the maximum allowed capacity.
8. When the **Create Volume** item is selected, press <Enter>. The following warning message appears:



9. Press <Y> to create the RAID volume and return to the main menu, or <N> to go back to the **CREATE VOLUME** menu.

Deleting a RAID set



Take caution when deleting a RAID set. You will lose all data on the hard disk drives when you delete a RAID set.

To delete a RAID set:

1. From the utility main menu, select **2. Delete RAID Volume** and press <Enter>. The following screen appears:

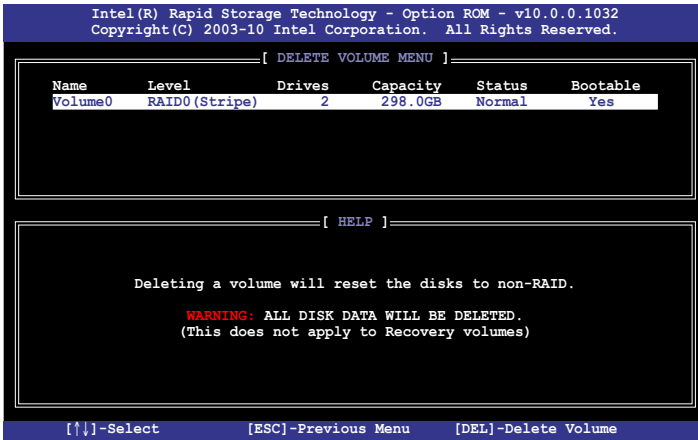

2. Use the up/down arrow key to select the RAID set you want to delete, and then press . The following warning message appears:

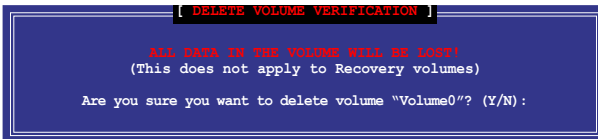

3. Press <Y> to delete the RAID set and return to the utility main menu, or press <N> to return to the **DELETE VOLUME** menu.

Exiting the Intel® Rapid Storage Technology Option ROM utility

To exit the utility:

1. From the utility main menu, select **5. Exit**, and then press <Enter>. The following warning message appears:

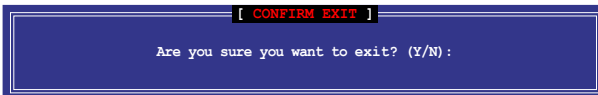

2. Press <Y> to exit or press <N> to return to the utility main menu.

4.4.5 Intel® 2012 Desktop responsiveness technologies

This section details the overview of the installation and configuration procedures of the Intel® 2012 Desktop responsiveness technologies.

Intel® 2012 Desktop responsiveness technologies feature the three technologies:

- Intel® Smart Response Technology
- Intel® Rapid Start Technology
- Intel® Smart Connect Technology

System Requirements

In order for the system to run smoothly for the Intel® 2012 Desktop responsiveness, your system must meet the following requirements:

- CPU: Intel® 3rd/2nd generation Core Processor family
- OS: Windows® 7 operating system
- SSD: One dedicated SSD (Solid State Disk) to support Intel® Smart Response and Intel® Rapid Start Technology is necessary.



Refer to the **SSD Capacity Requirements** table for the information of SSD size, partition capacity, and system memory requirements.

- HDD: At least one HDD (Hard Disk Drive) for the system OS drive.
- DRAM: To enable Intel® Rapid Start Technology, DRAM size should be at least 8GB.



Ensure to enable the acceleration of Intel® Smart Response Technology before creating the partition for the Intel® Rapid Start Technology.

SSD Capacity Requirements

SSD Partition Capacity Requirements		System DRAM		
		2GB	4GB	8GB
Intel® storage combinations	Intel® Rapid Start	2GB	4GB	8GB
	Intel® Smart Response	20GB	20GB	20GB
	Intel® Smart Response and Intel® Rapid Start	Separate 20GB and 2GB partition (SSD size > 22GB)	Separate 20GB and 4GB partition (SSD size > 24GB)	Separate 20GB and 8GB partition (SSD size > 28GB)
	Intel® Smart Response, Intel® Rapid Start, and Intel® Smart Connect	Separate 20GB and 2GB partition (SSD size > 22GB)	Separate 20GB and 4GB partition (SSD size > 24GB)	Separate 20GB and 8GB partition (SSD size > 28GB)



- You cannot create RAID drivers on the SSD for Intel® Rapid Start and Intel® Smart Response.
- Due to OS behavior, Intel® Rapid Start Technology will not work properly on system memory over 4GB under Windows® 7 32-bit operating system.
- Only Intel® internal SATA ports (gray and blue) support Intel® 2012 Desktop responsiveness technologies.
- The performance of Intel® Smart Response Technology and Intel® Rapid Storage Technology vary with the installed SSD.

Intel® Smart Response Technology

Intel® Smart Response Technology boosts overall system performance. It uses an installed SSD with at least 20GB size as a cache for frequently-accessed operations. It speeds up hard drive and main memory interaction, reduces load and wait time, maximizes storage usage, and saves power via the reduction on unnecessary hard drive spin.



Before applying Intel® Smart Response Technology, setting the SATA Mode BIOS item to [RAID mode] in BIOS setup is necessary. Refer to section 3.5.3 **SATA Configuration** for details

Installing Intel® Smart Response Technology

1. Place the support DVD to the optical drive. The installation wizard appears if your computer has enabled the Autorun feature.
2. Click the **Drivers** tab, then click **Intel® Rapid Storage Technology Driver** software.
3. Follow the onscreen instructions to complete the installation.

Using the Intel® Smart Response Technology

1. Click **Accelerate** to launch Smart Response Technology settings.

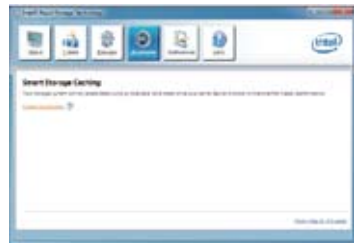

2. Follow these steps to configure the acceleration settings:
 - a. Select the SSD you want to use to accelerate your storage system.
 - b. Select the size allocated for SSD caching.
 - c. Select the disk or volume you want to use for caching.
 - d. Select any of these modes:

Enhanced mode: This mode writes through, writes to SSD and HDD at the same time.

Maximized mode: This mode writes back, writes to SSD, and writes back to HDD at a specified time.



3. Select **Disable Acceleration** to disable this function, and select **Change Mode** to



- To enable Intel® Smart Response Technology, you need at least one SSD (≥ 20GB) and an HDD, and only one SSD can be assigned for caching.
- If you want to restore the OS, go to **BIOS Option ROM > Acceleration Options** and remove the **Disks/Volume Acceleration** to disable Intel® Smart Response Technology. Refer to Chapter 4, section Installing Serial ATA hard disk for the entry of BIOS Option ROM.
- The maximum caching size on the SSD is 64GB. If it exceeds, the storage capacity left out for caching can still be identified by the system for normal storage.

Intel® Rapid Start Technology

Intel® Rapid Start Technology allows your system to quickly wake up from sleep mode.



- Before applying Intel® Rapid Start Technology, go to **Advanced Mode > Advanced > PCH Configuration** in BIOS item, and enable Intel® Rapid Start Technology.
- Ensure to follow the procedure **Creating a partition** precisely to enable the Intel Rapid Start function. Error message appears if you install the Intel® Rapid Start Utility before creating a partition.

Creating a partition



- Ensure to back up your data before using the Microsoft partition tool. Incorrect partitioning process will result to data loss.
- Adjusting the DRAM to a high frequency will result to an unstable system performance.

To create a partition:

1. Go to Start, right-click **Computer > Manage > Disk Management**.
2. Select the SSD that you want to partition.

3. Right click the **New Volume** that you want to shrink from, and select **Shrink Volume**.

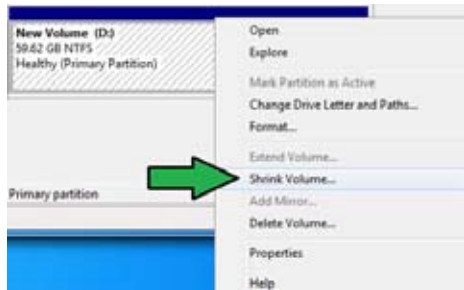

4. If your SSD is not initialized and not formatted:
 - a. Right-click the disk that you want to partition, and select **Initialize**.
 - b. Right-click the unallocated volume, select **New Simple Volume**, and follow the remaining steps.



If your SSD is smaller than 64GB, and is set to **Full disk capacity** caching option for Intel® Smart Response, you cannot see any volume in the Disk Management. Ensure to set your cache memory value of **18.6GB** in Intel® Smart Response to allow enough capacity for the Intel® Rapid Start partition.

5. Key in the required partition size, which must be equal to the system DRAM memory (1GB = 1024MB). Click **Shrink**.

Go to **Start > Control Panel > System and Security > System**, and check the DRAM size information.

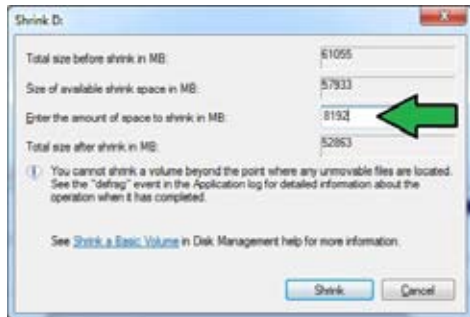

The unallocated volume is allocated to the selected disk.

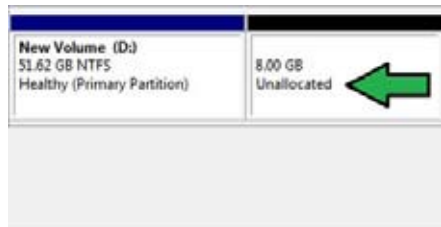

12. Type `set id=84 override`, press **Enter**, and wait for the “shrinking process” until the Disk Management utility identifies a new partition called **Hibernation Partition**.

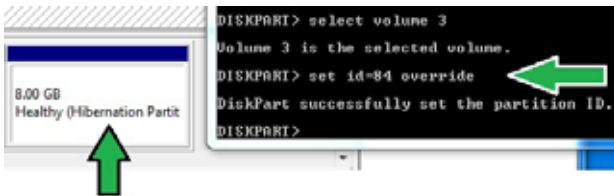

The **Hibernation Partition** does not appear when you choose “GPT (GUID Partition Table store type)”. Ensure the “Unallocated” disappears from the volume, and a new partition is identified.

13. Reboot the system after creating the partition.



If the system is not rebooted, the partition will not be completed and Intel® Rapid Start Technology will not work properly.

Enabling and disabling the Intel® Rapid Start Technology



Install the Intel® Rapid Start Technology first from your support DVD in order to launch the Intel® Rapid Start Manager.

After creating the partition, launch the Intel® Rapid Start Manager to enable or disable the Intel® Rapid Start Technology.

1. Click the **Show hidden icons** arrow from the right side of the task bar, and click **Intel® Rapid Start Technology Manager** icon.

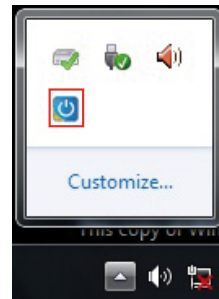

2. Tick **On** in the Status field to enable the function, and click **Save**.

Select and click to enable or disable the function

Click to enable or disable battery saving mode. This function only applies to notebooks.

Click to enable or disable the timer. When enabled, move the scroll bar to the desired time. When the system is idle for more than the time period you set, the system automatically goes into the Intel® Rapid Start mode. Default time is 10 minutes.

Click to save the settings made. Click to cancel the settings made.

Recovering the partition

This procedure allows you to delete the Intel® Rapid Start Technology from your system and recover the partition you made for the Intel Rapid Start Technology installation.

1. Run the **Command Prompt** tool.
2. Type `diskpart` and press **Enter**.
3. At the `diskpart` prompt, type `list disk` after `DISKPART`, and press **Enter**.

```
DISKPART> list disk

```

Disk ###	Status	Size	Free	Dyn	Gpt
Disk 0	Online	2794 GB	1024 KB		*
Disk 1	Online	59 GB	0 B		

```
DISKPART>
```

4. Select the disk (SSD) where the Intel® Rapid Start Technology is installed for volume recovery, type `select disk x` (x = number), and press **Enter**.

```
DISKPART> select disk 1
Disk 1 is now the selected disk.
DISKPART>
```



The value "x" refers to a disk number where you want to delete the store partition.

- Type `list partition`, press **Enter**, and select the partition where the Intel® Rapid Start Technology is installed by typing `select partition x` (x = number), and press **Enter**.

```
DISKPART> list partition

Partition ###  Type                Size      Offset
-----
Partition 1   Primary             51 GB     1024 KB
Partition 2   OEM                  8 GB      51 GB

DISKPART> select partition 2

Partition 2 is now the selected partition.

DISKPART>
```



The value “x” refers to a disk number where you want to delete the store partition.

- Type `delete partition override`, and press **Enter**. The diskpart utility deletes the selected partition.

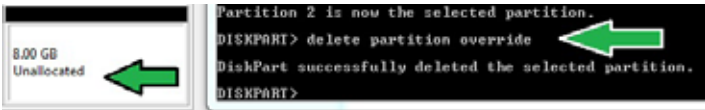

- In the desktop, click **Start**, right-click **Computer**, and click **Manage**.
- In the Computer Management window, click **Disk Management**, right click the shrunk new volume, and select **Extend Volume**.

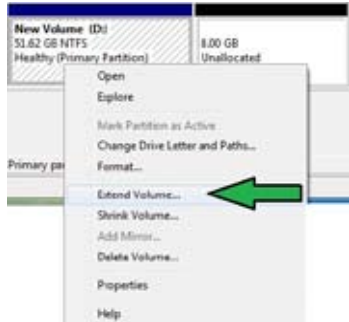

- As the Extend Volume Wizard appears, click **Next**.



10. Click **Next** after selecting the default selected disk.

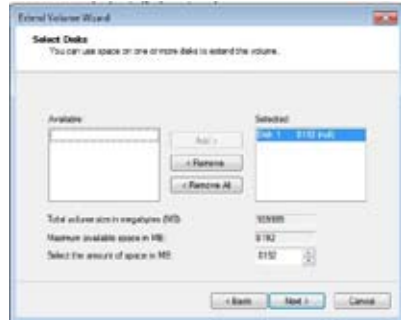

11. Extend volume setup is completed. Click **Finish** to recover the Intel® Rapid Start Technology partition.
12. Reboot the system after deleting the partition.
13. Go to **Start > Control Panel > Programs > Programs and Features >** to remove the Intel® Rapid Start Manager for the complete deletion of Intel® Rapid Start Technology.

Intel® Smart Connect Technology

The Intel® Smart Connect Technology is a feature that provides the latest content updates and energy efficiency to your computer's platform.

Once installed and activated, Intel® Smart Connect Technology periodically wakes up the system from sleep mode, performs user state gathering, and initiates re-entry to sleep mode to wake-up after a set time interval.



- Intel® Smart Connect Technology supports Windows® Live Mail, Microsoft Outlook, and Seismic applications.
- It is necessary to enable the items of the PCH Configuration in the BIOS before applying the Intel® Smart Connect Technology. Go to **Advanced Mode > Advanced > PCH Configuration**, and enable the Intel® Smart Connect Technology.

Installing the Intel® Smart Connect Technology

1. Place the support DVD to the optical drive.
2. Go to **Utilities**, and click **Intel® Smart Connect Technology**.
3. As the setup wizard appears, click **Next** to begin the setup.
4. Tick **I accept the terms in the License Agreement**, and click **Next**.

5. Select all and click **Next** for **Custom Setup**.

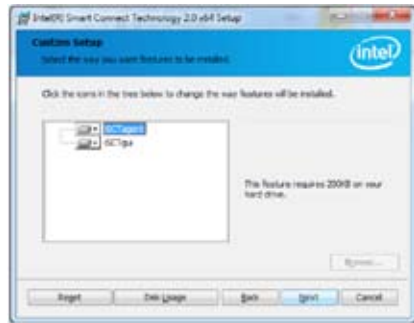

6. Click Install to proceed the installation.
7. Click Yes to restart your system, and for the newly installed Intel® Smart Connect Technology to take effect.

Using the Intel® Smart Connect Technology



- Before the system goes to sleep mode, ensure to keep your applications on the desktop, and enter the applications, passwords.
- Ensure that the internet is in connection when enabling the Intel® Smart Connect Technology.

1. Click **Start > All Programs > Intel > Intel® Smart Connect Technology**.
2. In the **Basic** tab, click **Enable Updating**. When enabled, the **Advanced** tab is available for advanced function settings.

The Advanced tab is activated when updating is enabled

Click to view version information and help topics

Click to configure the basic settings

Click to enable or disable the function

When updating is enabled, click to reset all settings to default.

When the scroll bar is activated, adjust the waking up time period for Internet data update.

- To disable the updating function, click **Disable Updating**. Clicking this button automatically disables the configuration in the **Advanced** tab. To reset to defaults, click **Reset All to Defaults**.

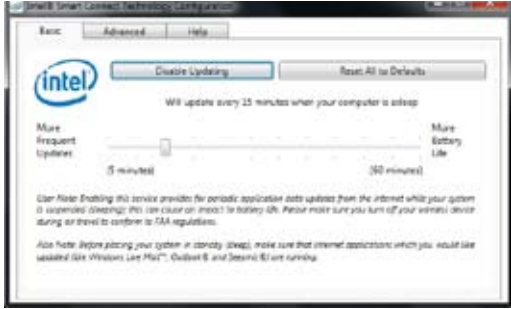

- In the **Advanced** tab, set up the schedule during low power usage time period for power saving. This setting only applies to the assigned time period.



- In the **Help** tab, click **About** to view the feature's version. Click **Topics** to learn more about the Intel® Smart Connect Technology and its configuration.

4.5 Creating a RAID driver disk

A floppy disk with the RAID driver is required when installing a Windows® operating system on a hard disk drive that is included in a RAID set.



- **The motherboard does not provide a floppy drive connector.** You have to use a USB floppy disk drive when creating a **SATA** RAID driver disk.
- Windows® XP may not recognize the USB floppy disk drive due to Windows® XP limitation. To work around this OS limitation, refer to section **4.5.4 Using a USB floppy disk drive**.

4.5.1 Creating a RAID driver disk without entering the OS

To create a RAID driver disk without entering the OS:

1. Boot your computer.
2. Press during POST to enter the BIOS setup utility.
3. Set the optical drive as the primary boot device.
4. Insert the support DVD into the optical drive.
5. Save changes and exit BIOS.
6. When the **Make Disk** menu appears, press <1> to create a RAID driver disk.
7. Insert a formatted floppy disk into the USB floppy disk drive, then press <Enter>.
8. Follow the succeeding screen instructions to complete the process.

4.5.2 Creating a RAID driver disk in Windows®

To create a RAID driver disk in Windows®:

1. Start Windows®.
2. Plug the USB floppy disk drive and insert a floppy disk.
3. Place the motherboard support DVD into the optical drive.
4. Go to the **Make Disk** menu, and then click **Intel AHCI/RAID Driver Disk** to create a RAID driver disk.
5. Select USB floppy disk drive as the destination disk.
6. Follow the succeeding screen instructions to complete the process.



Write-protect the floppy disk to avoid a computer virus infection.

4.5.3 Installing the RAID driver during Windows® OS installation

To install the RAID driver in Windows® XP:

1. During the OS installation, the system prompts you to press the F6 key to install third-party SCSI or RAID driver.
2. Press <F6>, and then insert the floppy disk with RAID driver into the USB floppy disk drive.
3. When prompted to select the SCSI adapter to install, select the RAID driver for the corresponding OS version.
4. Follow the succeeding screen instructions to complete the installation.

To install the RAID driver for Windows® 7 or later OS:

1. During the OS installation, click **Load Driver** to allow you to select the installation media containing the RAID driver.
2. Insert the USB flash drive with RAID driver into the USB port or the support DVD into the optical drive, and then click **Browse**.
3. Click the name of the device you've inserted, go to **Drivers > RAID**, and then select the RAID driver for the corresponding OS version. Click **OK**.
4. Follow the succeeding screen instructions to complete the installation.



Before loading the RAID driver from a USB flash drive, you have to use another computer to copy the RAID driver from the support DVD to the USB flash drive.

4.5.4 Using a USB floppy disk drive

Due to OS limitation, Windows® XP may not recognize the USB floppy disk drive when you install the RAID driver from a floppy disk during the OS installation.

To solve this issue, add the USB floppy disk drive's Vendor ID (VID) and Product ID (PID) to the floppy disk containing the RAID driver. Refer to the steps below:

1. Using another computer, plug the USB floppy disk drive, and insert the floppy disk containing the RAID driver.
2. Right-click **My Computer** on the Windows® desktop or **start** menu, and then select **Manage** from the pop-up window.

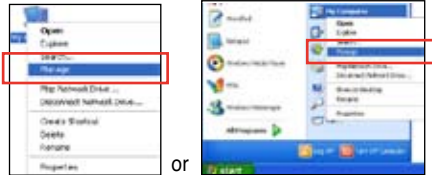

3. Select **Device Manager**. From the **Universal Serial Bus controllers**, right-click **xxxxxx USB Floppy**, and then select **Properties** from the pop-up window.



The name of the USB floppy disk drive varies with different vendors.

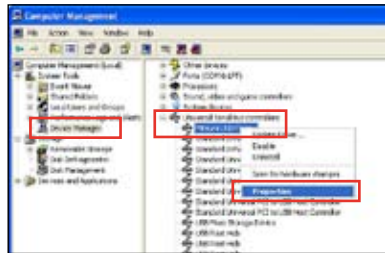

4. Click **Details** tab. The Vendor ID (VID) and Product ID (PID) are displayed.

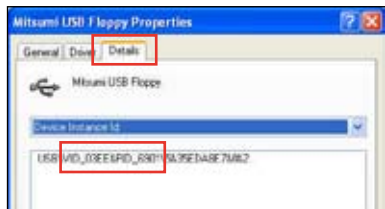

5. Browse the contents of the RAID driver disk to locate the file **txtsetup.oem**.
6. Double-click the file. A window appears, allowing you to select the program for opening the oem file.

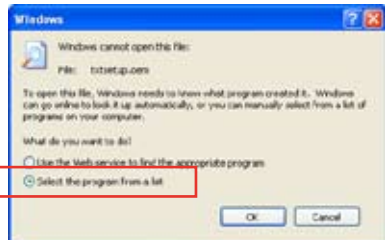

7. Use Notepad to open the file.



8. Find the `[HardwareIds.scsi.iaAHCI_DesktopWorkstationServer]` and `[HardwareIds.scsi.iaStor_DesktopWorkstationServer]` sections in the `txtsetup.oem` file.
9. Type the following line to the bottom of the two sections:
`id = "USB\VID_XXXX&PID_XXXX", "usbstor"`

```
[HardwareIds.scsi.iaAHCI_DesktopWorkstationServer]
id= "PCI\VEN_8086&DEV_1C02&CC_0106", "iaStor"
id= "USB\VID_03EE&PID_6901", "usbstor"

[HardwareIds.scsi.iaStor_DesktopWorkstationServer]
id= "PCI\VEN_8086&DEV_2822&CC_0104", "iaStor"
id= "USB\VID_03EE&PID_6901", "usbstor"
```



Add the same line to both sections.



The VID and PID vary with different vendors.

10. Save and exit the file.

5.1 AMD® CrossFireX™ technology

The motherboard supports the AMD® CrossFireX™ technology that allows you to install multi-graphics processing units (GPU) graphics cards. Follow the installation procedures in this section.

5.1.1 Requirements

- In Dual CrossFireX mode, you should have two identical CrossFireX-ready graphics cards or one CrossFireX-ready dual-GPU graphics card that are AMD® certified.
- Ensure that your graphics card driver supports the AMD CrossFireX technology. Download the latest driver from the AMD website (www.amd.com).
- Ensure that your power supply unit (PSU) can provide at least the minimum power required by your system. See Chapter 2 for details.



-
- We recommend that you install additional chassis fans for better thermal environment.
 - Visit the AMD Game website (<http://game.amd.com>) for the latest certified graphics card and the supported 3D application list.
-

5.1.2 Before you begin

For AMD CrossFireX to work properly, you have to uninstall all existing graphics card drivers before installing AMD CrossFireX graphics cards to your system.

To uninstall existing graphics card drivers:

1. Close all current applications.
2. For Windows XP, go to **Control Panel > Add/Remove Programs**.
For Windows 7, go to **Control Panel > Programs > Programs and Features**.
3. Select your current graphics card driver/s.
4. For Windows XP, select **Add/Remove**.
For Windows 7, select **Uninstall**.
5. Turn off your computer.

5.1.3 Installing two CrossFireX™ graphics cards



The following pictures are for reference only. The graphics cards and the motherboard layout may vary with models, but the installation steps remain the same.

1. Prepare two CrossFireX-ready graphics cards.
2. Insert the two graphics card into the PCIEX16 slots. If your motherboard has more than two PCIEX16 slots, refer to Chapter 2 in this user manual for the locations of the PCIEX16 slots recommended for multi-graphics card installation.
3. Ensure that the cards are properly seated on the slots.
4. Align and firmly insert the CrossFireX bridge connector to the goldfingers on each graphics card. Ensure that the connector is firmly in place.

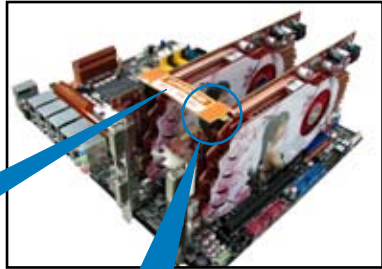
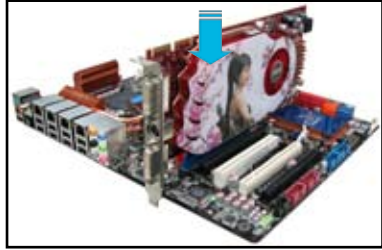

**CrossFireX bridge
(bundled with
graphics cards)**



5. Connect two independent auxiliary power sources from the power supply to the two graphics cards separately.
6. Connect a VGA or a DVI cable to the graphics card.

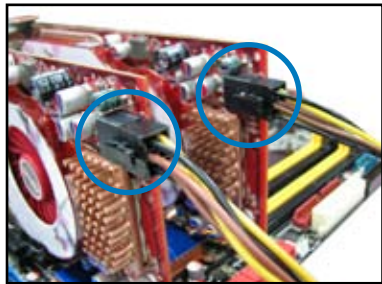

5.1.4 Installing the device drivers

Refer to the documentation that came with your graphics card package to install the device drivers.



Ensure that your PCI Express graphics card driver supports the AMD® CrossFireX™ technology. Download the latest driver from the AMD website (www.amd.com).

5.1.5 Enabling the AMD® CrossFireX™ technology

After installing your graphics cards and the device drivers, enable the CrossFireX™ feature through the AMD Catalyst™ Control Center in Windows environment.

Launching the AMD VISION Engine Control Center

To launch the AMD VISION Engine Control Center:

1. Right-click on the Windows® desktop and select **AMD VISION Engine Control Center**. You can also right-click the AMD icon in the Windows notification area and select **Vision Engine Control Center**.



2. The **VISION Engine Control Center Setup Assistant** appears when the system detects the existence of multi-graphics cards. Click **Go** to continue to the **VISION Engine Control Center Advanced View** window.



Enabling Dual CrossFireX technology

1. In the Catalyst Control Center window, click **Graphics Settings > Performance > AMD CrossFireX™ Configuration**.
2. From the Graphics Adapter list, select the graphics card to act as the display GPU.
3. Select **Enable CrossFireX™**.
4. Click **Apply**, and then click **OK** to exit the window.



5.2 NVIDIA® SLI™ technology

The motherboard supports the NVIDIA® SLI™ (Scalable Link Interface) technology that allows you to install multi-graphics processing units (GPU) graphics cards. Follow the installation procedures in this section.

5.2.1 Requirements

- In SLI mode, you should have two identical SLI-ready graphics cards that are NVIDIA® certified.
- Ensure that your graphics card driver supports the NVIDIA SLI technology. Download the latest driver from the NVIDIA website (www.nvidia.com).
- Ensure that your power supply unit (PSU) can provide at least the minimum power required by your system. See Chapter 2 for details.



- We recommend that you install additional chassis fans for better thermal environment.
- Visit the NVIDIA zone website (<http://www.nzone.com>) for the latest certified graphics card and supported 3D application list.

5.2.2 Installing two SLI-ready graphics cards



The following pictures are for reference only. The graphics cards and the motherboard layout may vary with models, but the installation steps remain the same.

1. Prepare two SLI-ready graphics cards.
2. Insert the two graphics card into the PCIEX16 slots. If your motherboard has more than two PCIEX16 slots, refer to Chapter 2 in this user manual for the locations of the PCIEX16 slots recommended for multi-graphics card installation.
3. Ensure that the cards are properly seated on the slots.

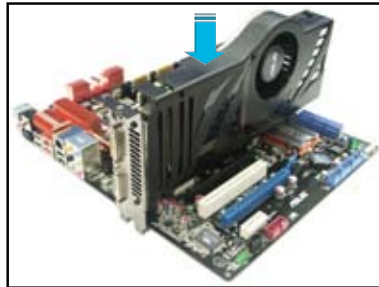

4. Align and firmly insert the SLI bridge connector to the goldfingers on each graphics card. Ensure that the connector is firmly in place.
5. Connect two independent auxiliary power sources from the power supply to the two graphics cards separately.
6. Connect a VGA or a DVI cable to the graphics card.

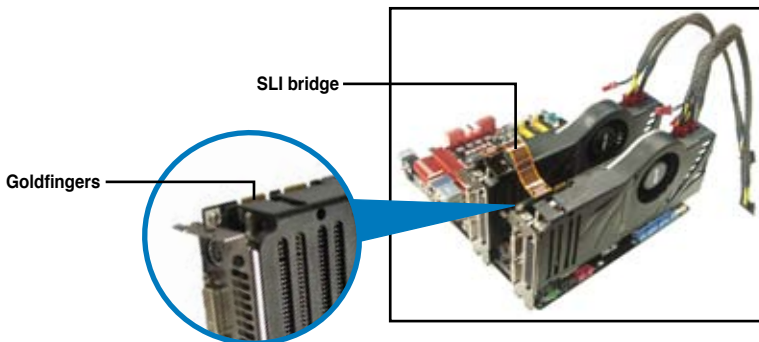

5.2.3 Installing the device drivers

Refer to the documentation that came with your graphics card package to install the device drivers.



Ensure that your PCI Express graphics card driver supports the NVIDIA® SLI™ technology. Download the latest driver from the NVIDIA website (www.nvidia.com).

5.2.4 Enabling the NVIDIA® SLI™ technology

After installing your graphics cards and the device drivers, enable the SLI feature in NVIDIA® Control Panel under the Windows® 7™ operating system.

Launching the NVIDIA Control Panel

You can launch the NVIDIA Control Panel by the following two methods.

- A. Right click on the empty space of the Windows® desktop and select **NVIDIA Control Panel**.
The NVIDIA Control Panel window appears (See Step B5).

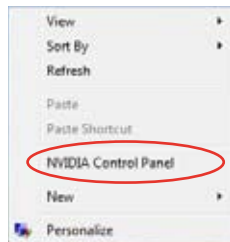

- B1. If you cannot see the NVIDIA Control Panel item in step (A), select **Personalize**.

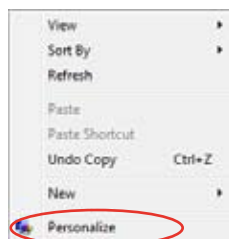

- B2. From the **Personalization** window, select **Display Settings**.

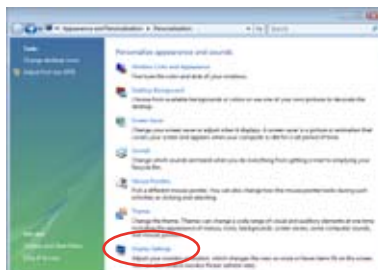

- B3. From the Display Settings dialog box, click **Advanced Settings**.

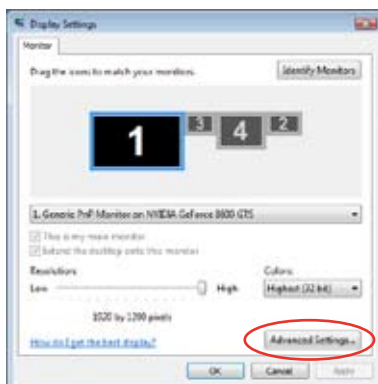

- B4. Select the NVIDIA GeForce tab, and then click **Start the NVIDIA Control Panel**.



- B5. The NVIDIA Control Panel window appears.



Enabling SLI settings

From the NVIDIA Control Panel window, select **Set SLI Configuration**. Click **Enable SLI** and set the display for viewing SLI rendered content. When done, click **Apply**.



5.3 LucidLogix Virtu MVP

LucidLogix Virtu MVP allows your computer's VGA output and discrete graphic cards to perform better, respond faster and process media files smoother within a low power environment. Its GPU virtualization assigns tasks to the best available graphic source while the newly-designed Virtual Vsync gives you a smoother gaming experience.



-
- LucidLogix Virtu MVP supports Windows 7® operating systems.
 - Intel® Quick Sync Video feature is supported by the 3rd/2nd generation Intel® Core™ processor family.
 - iGPU Multi-Monitor support option must be enabled in BIOS and install both Intel® Graphics Accelerator, and graphics card driver before installing LucidLogix Virtu MVP from ASUS support DVD. Refer to **3.5.4 System Configuration** for details.
 - Hyperformance® and Virtual Sync are enabled when using more than one discrete GPU at the same time.
 - Supports NVIDIA® GF4xx/5xx series and AMD® HD5xxx/6xxx series graphic cards.
 - We do not recommended to use LucidLogix Virtu MVP under RAID mode.
-

5.3.1 Installing LucidLogix Virtu MVP

To install LucidLogix Virtu MVP:

1. Insert the support DVD in the optical drive. The **ASUS Support Wizard** appears if your computer has enabled the Autorun feature.
2. Click the **Utilites** tab, then click **LucidLogix Virtu MVP Software**.
3. Follow the succeeding onscreen instructions to complete the installation.



After you successfully installed the LucidLogix Virtu MVP, the LucidLogix Virtu MVP icon appears in the notification area.

5.3.2 Setting up your display

LucidLogix Virtu MVP solution comes with two distinct modes that allows you to enjoy better graphics either from your built-in video output (i-Mode) or from a discrete graphics card (d-Mode).

i-Mode

To use LucidLogix Virtu MVP in i-Mode, the display must be connected to the onboard video output.



Ensure to set the Primary Display to iGPU in BIOS to activate i-Mode support.

d-Mode

To use LucidLogix Virtu MVP in d-Mode, the display must be connected to the installed graphics card.



-
- Ensure to set the Primary Display to PCIE or PCIE/PCI in BIOS to enable d-Mode support.
 - d-Mode is recommended for an enhanced 3D gaming performance.
-

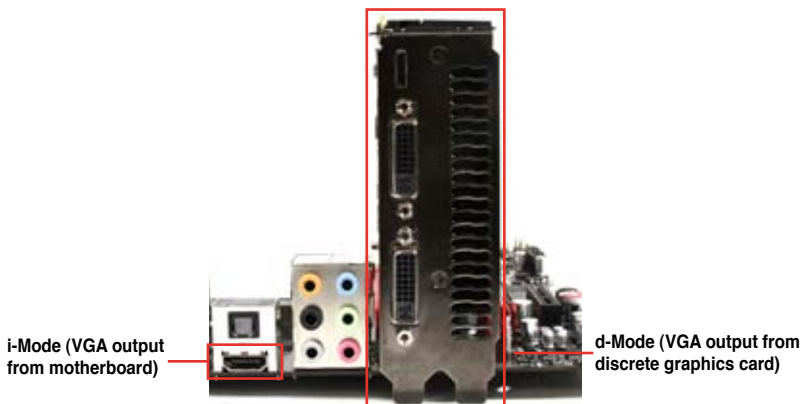

The motherboard's IO ports and discrete graphic card is for reference only and may vary in different models.

5.3.3 Configuring LucidLogix Virtu MVP

Launch the Virtu MVP Control Panel to allow you to configure the main features, adjust the performance settings and select applications for graphical virtualization.

To open the control panel, right-click LucidLogix Virtu MVP icon in the notification area and select **Open Virtu MVP Control Panel**.

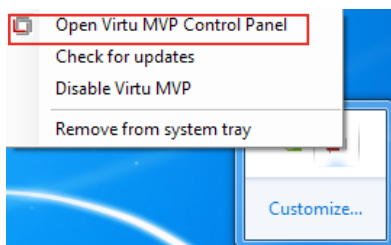

LucidLogix Virtu MVP is automatically activated when your system is powered on. Select **Remove from system tray** if you want to remove LucidLogix Virtu MVP icon from the notification area.

Main

Allows you to turn ON/OFF the GPU virtualization. Also from the Main tab, you can set to show or hide the In-Game icon.



Performance

Allows you to turn ON/OFF the Hyperformance® or Virtual Vsync function.

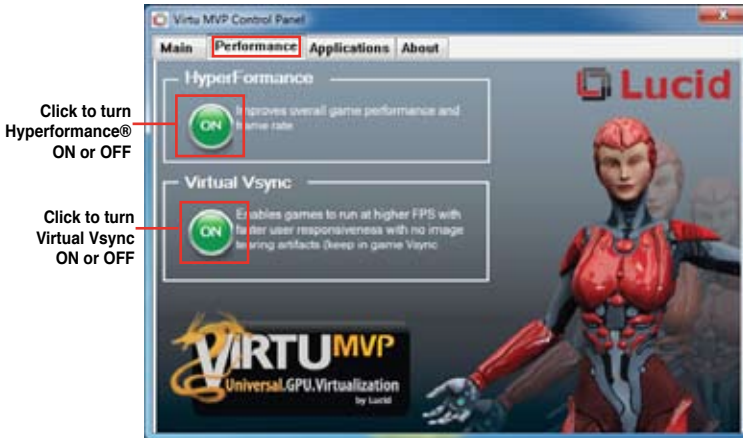

Applications

Allows you to select applications for graphic virtualization.

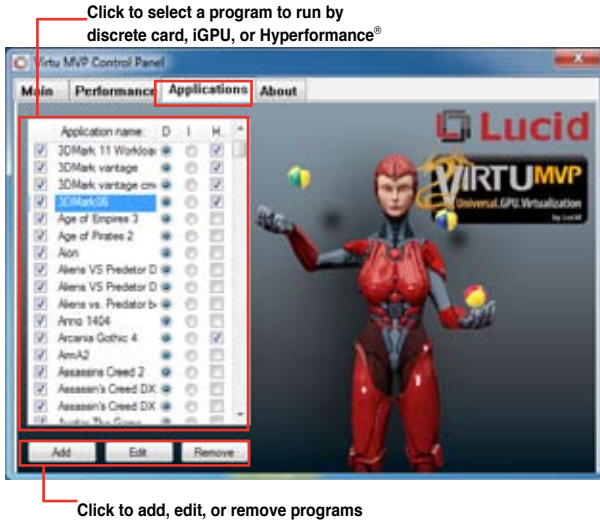

See the descriptions of these columns below:

- **D** column allows you to run applications with the discrete graphic card. Select **D** to enable 3D graphical performance for that application.
- **I** column allows to run applications with iGPU. Select **I** for applications with media extensive performance.
- **H** column allows you to run applications with Hyperformance®. Tick **H** to enhance graphical performance for that application.



Actual graphical performance varies with the application used and graphics card installed.

Appendices

Notices

Federal Communications Commission Statement

This device complies with Part 15 of the FCC Rules. Operation is subject to the following two conditions:

- This device may not cause harmful interference.
- This device must accept any interference received including interference that may cause undesired operation.

This equipment has been tested and found to comply with the limits for a Class B digital device, pursuant to Part 15 of the FCC Rules. These limits are designed to provide reasonable protection against harmful interference in a residential installation. This equipment generates, uses and can radiate radio frequency energy and, if not installed and used in accordance with manufacturer's instructions, may cause harmful interference to radio communications. However, there is no guarantee that interference will not occur in a particular installation. If this equipment does cause harmful interference to radio or television reception, which can be determined by turning the equipment off and on, the user is encouraged to try to correct the interference by one or more of the following measures:

- Reorient or relocate the receiving antenna.
- Increase the separation between the equipment and receiver.
- Connect the equipment to an outlet on a circuit different from that to which the receiver is connected.
- Consult the dealer or an experienced radio/TV technician for help.



The use of shielded cables for connection of the monitor to the graphics card is required to assure compliance with FCC regulations. Changes or modifications to this unit not expressly approved by the party responsible for compliance could void the user's authority to operate this equipment.

IC: Canadian Compliance Statement

Complies with the Canadian ICES-003 Class B specifications. This device complies with RSS 210 of Industry Canada. This Class B device meets all the requirements of the Canadian interference-causing equipment regulations.

This device complies with Industry Canada license exempt RSS standard(s). Operation is subject to the following two conditions: (1) this device may not cause interference, and (2) this device must accept any interference, including interference that may cause undesired operation of the device.

Cet appareil numérique de la Classe B est conforme à la norme NMB-003 du Canada. Cet appareil numérique de la Classe B respecte toutes les exigences du Règlement sur le matériel brouilleur du Canada.

Cet appareil est conforme aux normes CNR exemptes de licence d'Industrie Canada. Le fonctionnement est soumis aux deux conditions suivantes :

- (1) cet appareil ne doit pas provoquer d'interférences et
- (2) cet appareil doit accepter toute interférence, y compris celles susceptibles de provoquer un fonctionnement non souhaité de l'appareil.

Canadian Department of Communications Statement

This digital apparatus does not exceed the Class B limits for radio noise emissions from digital apparatus set out in the Radio Interference Regulations of the Canadian Department of Communications.

This class B digital apparatus complies with Canadian ICES-003.

VCCI: Japan Compliance Statement

VCCI Class B Statement

情報処理装置等電波障害自主規制について

この装置は、情報処理装置等電波障害自主規制協議会（VCCI）の基準に基づくクラスB情報技術装置です。この装置は家庭環境で使用することを目的としていますが、この装置がラジオやテレビジョン受信機に近接して使用されると、受信障害を引き起こすことがあります。

取扱説明書に従って正しい取り扱いをして下さい。

KC: Korea Warning Statement

B급 기기 (가정용 방송통신기자재)

이 기기는 가정용(B급) 전자파적합기기로서 주로 가정에서 사용하는 것을 목적으로 하며, 모든 지역에서 사용할 수 있습니다.

*당해 무선설비는 전파혼신 가능성이 있으므로 인명안전과 관련된 서비스는 할 수 없습니다.

REACH

Complying with the REACH (Registration, Evaluation, Authorisation, and Restriction of Chemicals) regulatory framework, we published the chemical substances in our products at ASUS REACH website at <http://csr.asus.com/english/REACH.htm>.



DO NOT throw the motherboard in municipal waste. This product has been designed to enable proper reuse of parts and recycling. This symbol of the crossed out wheeled bin indicates that the product (electrical and electronic equipment) should not be placed in municipal waste. Check local regulations for disposal of electronic products.



DO NOT throw the mercury-containing button cell battery in municipal waste. This symbol of the crossed out wheeled bin indicates that the battery should not be placed in municipal waste.

ASUS Recycling/Takeback Services

ASUS recycling and takeback programs come from our commitment to the highest standards for protecting our environment. We believe in providing solutions for you to be able to responsibly recycle our products, batteries, other components as well as the packaging materials. Please go to <http://csr.asus.com/english/Takeback.htm> for detailed recycling information in different regions.

ASUS contact information

ASUSTeK COMPUTER INC.

Address	15 Li-Te Road, Peitou, Taipei, Taiwan 11259
Telephone	+886-2-2894-3447
Fax	+886-2-2890-7798
E-mail	info@asus.com.tw
Web site	www.asus.com.tw

Technical Support

Telephone	+86-21-38429911
Online support	support.asus.com

ASUS COMPUTER INTERNATIONAL (America)

Address	800 Corporate Way, Fremont, CA 94539, USA
Telephone	+1-812-282-3777
Fax	+1-510-608-4555
Web site	usa.asus.com

Technical Support

Telephone	+1-812-282-2787
Support fax	+1-812-284-0883
Online support	support.asus.com

ASUS COMPUTER GmbH (Germany and Austria)

Address	Harkort Str. 21-23, D-40880 Ratingen, Germany
Fax	+49-2102-959911
Web site	www.asus.de
Online contact	www.asus.de/sales

Technical Support

Telephone	+49-1805-010923*
Support Fax	+49-2102-9599-11
Online support	support.asus.com

* EUR 0.14/minute from a German fixed landline; EUR 0.42/minute from a mobile phone.

DECLARATION OF CONFORMITY

Per FCC Part 2 Section 2.1077(a)



Responsible Party Name: **Asus Computer International**

Address: **800 Corporate Way, Fremont, CA 94539.**

Phone/Fax No: **(510)739-3777/(510)608-4555**

hereby declares that the product

Product Name : Mother board

Model Number : SABERTOOTH Z77

Conforms to the following specifications:

- FCC Part 15, Subpart B, Unintentional Radiators
- FCC Part 15, Subpart C, Intentional Radiators
- FCC Part 15, Subpart E, Intentional Radiators

Supplementary Information:

This device complies with part 15 of the FCC Rules. Operation is subject to the following two conditions: (1) This device may not cause harmful interference, and (2) this device must accept any interference received, including interference that may cause undesired operation.

Representative Person's Name : Steve Chang / President

Signature : 
Date : Jan. 20, 2012

Ver. 110101

EC Declaration of Conformity



We, the undersigned,

Manufacturer: **ASUSTek COMPUTER INC.**
No. 150, LI-TE RD., PEITOU, TAIPEI 112, TAIWAN R.O.C.
Country: **TAIWAN**
Authorized representative in Europe: **ASUS COMPUTER GmbH**
Address, City: **HARKORT STR. 21-23, 40880 RATINGEN**
Country: **GERMANY**

declare the following apparatus:

Product name : **Mother board**
Model name : **SABERTOOTH Z77**

conform with the essential requirements of the following directives:

2004/108/EC-EMC Directive
 EN 55022:2006+A1:2007
 EN 61000-3-2:2006
 EN 61000-3-3:2008
 EN 55025:2007

1995/5/EC-R & TTE Directive

EN 301 485-1 V1.8.1 (2008-04)
 EN 301 485-3 V1.4 (2002-08)
 EN 300 440-2 V1.2.1 (2008-03)
 EN 301 511 V9.0.2 (2005-03)
 EN 301 485-2 V1.3.1 (2005-11)
 EN 301 485-4 V1.2.1 (2007-05)
 EN 301 893 V1.4.1 (2005-03)
 EN 301 489-24 V1.4.1 (2007-09)
 EN 302 554-2 V1.1.1 (2009-01)
 EN 302 386-2 V1.2.2 (2007-09)
 EN 302 386-3 V1.3.1 (2007-09)
 EN 301 352-2 V1.1 (2006-05)
 EN 301 352-3 V1.1 (2006-05)
 EN 302 623 V1.1.1 (2009-01)

2006/95/EC-LVD Directive

EN 60950-1 / A11:2009
 EN 60950-1 / A12:2011
 EN 60950-2002-A1:2006-A11:2008
 EN 60950-2002 / A12:2011

2009/125/EC-ERP Directive

Regulation (EC) No. 1275/2008
 EN 62301:2005
Regulation (EC) No. 642/2009
 EN 62301:2005
Ver. 11121



CE marking

(EC conformity marking)

Position : **CEO**
Name : **Jerry Shen**

Signature : 

Declaration Date: **Jan. 20, 2012**
Year to begin affixing CE marking: **2012**