

Intel® Desktop Board DZ68ZV Product Guide

Order Number: G42421-001

Revision History

Revision	Revision History	Date
-001	First release of the Intel® Desktop Board DZ68ZV Product Guide	September 2011

Disclaimer

INFORMATION IN THIS DOCUMENT IS PROVIDED IN CONNECTION WITH INTEL® PRODUCTS. NO LICENSE, EXPRESS OR IMPLIED, BY ESTOPPEL OR OTHERWISE, TO ANY INTELLECTUAL PROPERTY RIGHTS IS GRANTED BY THIS DOCUMENT. EXCEPT AS PROVIDED IN INTEL'S TERMS AND CONDITIONS OF SALE FOR SUCH PRODUCTS, INTEL ASSUMES NO LIABILITY WHATSOEVER, AND INTEL DISCLAIMS ANY EXPRESS OR IMPLIED WARRANTY, RELATING TO SALE AND/OR USE OF INTEL PRODUCTS INCLUDING LIABILITY OR WARRANTIES RELATING TO FITNESS FOR A PARTICULAR PURPOSE, MERCHANTABILITY, OR INFRINGEMENT OF ANY PATENT, COPYRIGHT OR OTHER INTELLECTUAL PROPERTY RIGHT. Intel products are not intended for use in medical, life saving, or life sustaining applications. Intel may make changes to specifications and product descriptions at any time, without notice.

Intel Desktop Board DZ68ZV may contain design defects or errors known as errata which may cause the product to deviate from published specifications. Current characterized errata are available on request. Contact your local Intel sales office or your distributor to obtain the latest specifications and before placing your product order.

Copies of documents which have an ordering number and are referenced in this document, or other Intel literature, may be obtained from Intel Corporation by going to the World Wide Web site at: <http://www.intel.com/> or by calling 1-800-548-4725.

Intel, Intel Core, and Xeon are trademarks of Intel Corporation in the United States and/or other countries.

* Other names and brands may be claimed as the property of others.

Preface

This Product Guide gives information about board layout, component installation, BIOS update, and regulatory requirements for Intel® Desktop Board DZ68ZV.

Intended Audience

The Product Guide is intended for technically qualified personnel. It is not intended for general audiences.

Use Only for Intended Applications

All Intel Desktop Boards are evaluated as Information Technology Equipment (I.T.E.) for use in personal computers (PC) for installation in homes, offices, schools, computer rooms, and similar locations. The suitability of this product for other PC or embedded non-PC applications or other environments, such as medical, industrial, alarm systems, test equipment, etc. may not be supported without further evaluation by Intel.

Document Organization

The chapters in this Product Guide are arranged as follows:

- 1 Desktop Board Features: a summary of product features
 - 2 Installing and Replacing Desktop Board Components: instructions on how to install the Desktop Board and other hardware components
 - 3 Updating the BIOS: instructions on how to update the BIOS
 - 4 Configuring for RAID Using Intel® Rapid Storage Technology: information about configuring your system for RAID
- A Error Messages and Indicators: information about BIOS error messages and beep codes
- B Regulatory Compliance: describes the board's adherence to safety standards and EMC regulations and its product certifications

Conventions

The following conventions are used in this manual:



CAUTION

Cautions warn the user about how to prevent damage to hardware or loss of data.



NOTE

Notes call attention to important information.

Terminology

The table below gives descriptions of some common terms used in the product guide.

Term	Description
GB	Gigabyte (1,073,741,824 bytes)
GHz	Gigahertz (one billion hertz)
KB	Kilobyte (1024 bytes)
MB	Megabyte (1,048,576 bytes)
Mb	Megabit (1,048,576 bits)
MHz	Megahertz (one million hertz)

Contents

1 Desktop Board Features

Supported Operating Systems.....	11
Desktop Board Components.....	12
Processor.....	14
Main Memory.....	15
Intel® Z68 Express Chipset.....	16
Intel® RST.....	16
Intel® RRT.....	16
Intel® Smart Response Technology.....	16
Audio Subsystem.....	18
LAN Subsystem.....	19
USB Support.....	20
Serial ATA Support.....	20
Legacy I/O.....	20
Expandability.....	20
Bluetooth*/WiFi Support.....	21
Bluetooth Technology.....	21
WiFi 802.11 Wireless.....	21
BIOS.....	22
Serial ATA Auto Configuration.....	22
PCI* and PCI Express* Auto Configuration.....	22
Security Passwords.....	22
Back to BIOS Button.....	23
Hardware Management.....	23
Hardware Monitoring and Fan Speed Control.....	24
Chassis Intrusion.....	24
Power Management.....	24
Software Support.....	24
ACPI.....	24
Hardware Support.....	25
Power Connectors.....	25
Fan Headers.....	25
LAN Wake Capabilities.....	25
Instantly Available PC Technology.....	26
Wake from USB.....	26
PME# Signal Wake-up Support.....	26
WAKE# Signal Wake-up Support.....	26
Wake from Consumer IR.....	26
Onboard Power and Reset Buttons.....	27
Processor and Voltage Regulator LEDs.....	28
Board Status LEDs.....	29
Speaker.....	30
Battery.....	30
Real-Time Clock.....	30

2 Installing and Replacing Desktop Board Components

Before You Begin	31
Installation Precautions	32
Prevent Power Supply Overload	32
Observe Safety and Regulatory Requirements.....	32
Installing the I/O Shield	33
Installing and Removing the Desktop Board	34
Installing and Removing a Processor	35
Installing a Processor	35
Installing the Processor Fan Heat Sink	39
Connecting the Processor Fan Heat Sink Cable.....	39
Removing the Processor	39
Installing and Removing System Memory	40
Guidelines for Dual Channel Memory Configuration.....	40
Two or Four DIMMs	40
Three DIMMs	41
Installing DIMMs	42
Removing DIMMs.....	44
Installing and Removing PCI Express x16 Graphics Cards.....	44
Installing a PCI Express x16 Graphics Card	44
Removing a PCI Express x16 Graphics Card.....	46
Installing Linked PCI Express Graphics Cards.....	46
Connecting the Serial ATA (SATA) Cables	48
Connecting to the Internal Headers	49
S/PDIF Header	50
IEEE 1394a Header.....	50
Front Panel Intel HD Audio Header	50
Alternate Front Panel Power LED Header	51
Consumer IR (CIR) Headers	51
USB 2.0 Headers	52
Front Panel Header	53
Chassis Intrusion Header	53
Connecting to the Audio System.....	54
Connecting Chassis Fan and Power Supply Cables.....	55
Connecting Chassis Fan Cables	55
Connecting Power Supply Cables	56
Setting the BIOS Configuration Jumper	57
Clearing Passwords	58
Replacing the Battery	59
Installing the WiFi/Bluetooth Module in a Desktop Chassis (optional)	65

3 Updating the BIOS

Updating the BIOS with the Intel® Express BIOS Update Utility.....	67
Updating the BIOS Using the F7 Function Key	68
Updating the BIOS with the Intel® Flash Memory Update Utility or the ISO Image BIOS Update File	68
Obtaining the BIOS Update File	68
Updating the BIOS with the Intel Flash Memory Update Utility.....	69
Updating the BIOS with the ISO Image BIOS Update File	69
Recovering the BIOS.....	70

4 Configuring Intel® Smart Response Technology and RAID Using Intel® RST

Configuring Intel Smart Response Technology	71
Configuring RAID	72
Configuring the BIOS	72
Creating Your RAID Set	72
Loading the Intel RST RAID Drivers and Software (Required for Microsoft Windows XP Installation)	73
Setting Up a "RAID Ready" System	73

A Error Messages and Indicators

BIOS Error Codes	75
BIOS Error Messages	76
Port 80h POST Codes	77

B Regulatory Compliance

Safety Standards	81
Battery Caution	81
European Union Declaration of Conformity Statement	82
Product Ecology Statements	83
Recycling Considerations	83
China RoHS	86
EMC Regulations	87
FCC Declaration of Conformity	87
Canadian Department of Communications Compliance Statement	88
Japan VCCI Statement	88
Korea Class B Statement	89
Ensure Electromagnetic Compatibility (EMC) Compliance	89
Product Certifications	90
Board-Level Certifications	90
Chassis- and Component-Level Certifications	91
Chassis and Component Certifications	91
ENERGY STAR*, e-Standby, and ErP Compliance	92

Figures

1. Intel Desktop Board DZ68ZV Components	12
2. LAN Connector LEDs	19
3. Location of the Back to BIOS Button	23
4. Onboard Power and Reset Buttons	27
5. Location of the Processor and Voltage Regulator LEDs	28
6. Location of the Board Status LEDs	30
7. Installing the I/O Shield	33
8. Intel Desktop Board DZ68ZV Mounting Screw Hole Locations	34
9. Unlatch the Socket Lever	35
10. Lift the Load Plate	36
11. Remove the Processor from the Protective Cover	37
12. Install the Processor	37
13. Secure the Load Plate in Place	38
14. Connecting the Processor Fan Heat Sink Power Cable to the Processor Fan Header	39

Intel Desktop Board DZ68ZV Product Guide

15. Example Dual Channel Memory Configuration with Two DIMMs	40
16. Example Dual Channel Memory Configuration with Four DIMMs	41
17. Example Dual Channel Memory Configuration with Three DIMMs	41
18. Use DDR3 DIMMs	42
19. Installing a DIMM	43
20. Installing a PCI Express x16 Graphics Card	45
21. Removing a PCI Express x16 Graphics Card.....	46
22. Installing Linked PCI Express Graphics Cards.....	47
23. Connecting the Serial ATA Cables.....	48
24. Internal Headers	49
25. Back Panel Audio Connectors	54
26. Location of the Chassis Fan Headers.....	55
27. Connecting Power Supply Cables	56
28. Location of the BIOS Configuration Jumper Block	57
29. Removing the Battery	64
30. Installing the WiFi/Bluetooth Module	66
31. POST Code LED Display	77
32. Intel Desktop Board DZ68ZV China RoHS Material Self Declaration Table.....	86

Tables

1. Feature Summary.....	9
2. Intel Desktop Board DZ68ZV Components.....	13
3. Audio Jack Retasking Support.....	18
4. LAN Connector LEDs	19
5. Board Status LEDs.....	29
6. S/PDIF Header Signal Names	50
7. IEEE 1394a Header Signal Names	50
8. Front Panel Intel HD Audio Header Signal Names	50
9. Alternate Front Panel Power LED Header Signal Names	51
10. Front Panel CIR Receiver (Input) Header Signal Names	51
11. Back Panel CIR Header Emitter (Output) Header Signal Names	52
12. USB 2.0 Header Signal Names.....	52
13. Front Panel Header Signal Names	53
14. Chassis Intrusion Header Signal Names	53
15. Jumper Settings for the BIOS Setup Program Modes.....	58
16. BIOS Beep Codes	75
17. Front-panel Power LED Blink Codes	75
18. BIOS Error Messages	76
19. Port 80h POST Codes	77
20. Safety Standards.....	81
21. EMC Regulations.....	87
22. Regulatory Compliance Marks.....	90

1 Desktop Board Features

This chapter briefly describes the features of Intel® Desktop Board DZ68ZV. Table 1 summarizes the major features of the Desktop Board.

Table 1. Feature Summary

Form Factor	ATX (304.80 millimeters [12.00 inches] x 243.84 millimeters [9.60 inches])
Processor	Support for an Intel® processor in the LGA1155 package
Main Memory	<ul style="list-style-type: none">• Four 240-pin DDR3 SDRAM Dual Inline Memory Module (DIMM) sockets arranged in two channels• Support for DDR3 2400 MHz to DDR3 1066 MHz DIMMs• Support for 1.35 V memory• Support for non-ECC memory• Support for up to 32 GB of memory
Chipset	Intel® Z68 Express Chipset consisting of the Intel Z68 Platform Controller Hub (PCH) with support for: <ul style="list-style-type: none">• Intel® Rapid Storage Technology (Intel® RST)• Intel® Smart Response Technology• Intel® Rapid Recover Technology (Intel® RRT)
Graphics	Support for multiple PCI Express* 2.0 graphics cards
Audio	<ul style="list-style-type: none">• Independent multi-streaming 8-channel (7.1) audio and 2-channel audio subsystem, featuring:<ul style="list-style-type: none">– Intel® High Definition (Intel® HD) Audio interface– Realtek* ALC892 codec• HD Audio front panel header• Onboard 4-pin S/PDIF out header• Back panel S/PDIF out optical connector (TOSLINK)
Expansion Capabilities	<ul style="list-style-type: none">• One PCI Express 2.0 x16 port• One PCI Express 2.0 x8 port (x8 electrical; 16 compatible)• Three PCI Express 2.0 x1 ports• Two PCI* bus connectors
Legacy I/O Support	Nuvoton W83677HG-I legacy I/O controller that provides Consumer Infrared (CIR) support

continued

Table 1. Feature Summary (continued)

<p>Peripheral Interfaces</p>	<p>USB Support:</p> <ul style="list-style-type: none"> • Two USB 3.0 ports implemented with stacked back panel connectors (blue) • Fourteen USB 2.0 ports: <ul style="list-style-type: none"> – Eight ports implemented with stacked back panel connectors – Six front panel ports implemented with three dual-port internal headers <p>Serial ATA Support:</p> <ul style="list-style-type: none"> • Two Serial ATA (SATA) 6.0 Gb/s ports (blue) • Four SATA 3.0 Gb/s ports • One external SATA (eSATA) 3.0 Gb/s port on the back panel <p>IEEE 1394a Support:</p> <ul style="list-style-type: none"> • One port routed to the back panel • One port routed to an IEEE 1394a header
<p>RAID</p>	<p>Intel® Rapid Storage Technology (Intel® RST) version 1.6</p>
<p>LAN Support</p>	<p>Intel 82579V Gigabit (10/100/1000 Mb/s) Ethernet LAN controller including an RJ-45 back panel connector with integrated status LEDs</p>
<p>BIOS</p>	<ul style="list-style-type: none"> • Intel® Platform Innovation Framework for extensible firmware interface • 32 Mb symmetrical flash memory device • Support for SMBIOS • Intel® Express BIOS Update
<p>Power Management</p>	<ul style="list-style-type: none"> • Support for Advanced Configuration and Power Interface (ACPI) • Suspend to RAM (STR) • Wake on USB, PCI, PCI Express, LAN, CIR, and front panel • ENERGY STAR* capable
<p>Hardware and Thermal Management</p>	<p>Hardware and thermal management based on:</p> <ul style="list-style-type: none"> – Nuvoton W83677HG-I legacy I/O controller – Four fan sensing inputs to monitor fan activity – Voltage sensing to detect out of range values

Supported Operating Systems

The Desktop Board provides full support for the following operating systems:

- Microsoft Windows* 7 Ultimate 64-bit edition
- Microsoft Windows 7 Ultimate 32-bit edition
- Microsoft Windows 7 Professional 64-bit edition
- Microsoft Windows 7 Professional 32-bit edition
- Microsoft Windows 7 Home Premium 64-bit edition
- Microsoft Windows 7 Home Premium 32-bit edition
- Microsoft Windows 7 Starter 64-bit edition
- Microsoft Windows 7 Starter 32-bit edition
- Microsoft Windows Vista* Ultimate 32-bit edition
- Microsoft Windows Vista Business 32-bit edition
- Microsoft Windows Vista Home Premium 32-bit edition
- Microsoft Windows Vista Home Basic 32-bit edition
- Microsoft Windows Vista Ultimate 64-bit edition
- Microsoft Windows Vista Business 64-bit edition
- Microsoft Windows Vista Home Premium 64-bit edition
- Microsoft Windows Vista Home Basic 64-bit edition

The Desktop Board provides limited support for the following operating systems:

- Microsoft Windows Vista Home Basic 64-bit edition
- Microsoft Windows* XP Media Center Edition 2005
- Microsoft Windows XP Professional
- Microsoft Windows XP Professional x64 Edition
- Microsoft Windows XP Home

Desktop Board Components

Figure 1 shows the approximate location of the major components on Intel Desktop Board DZ68ZV.

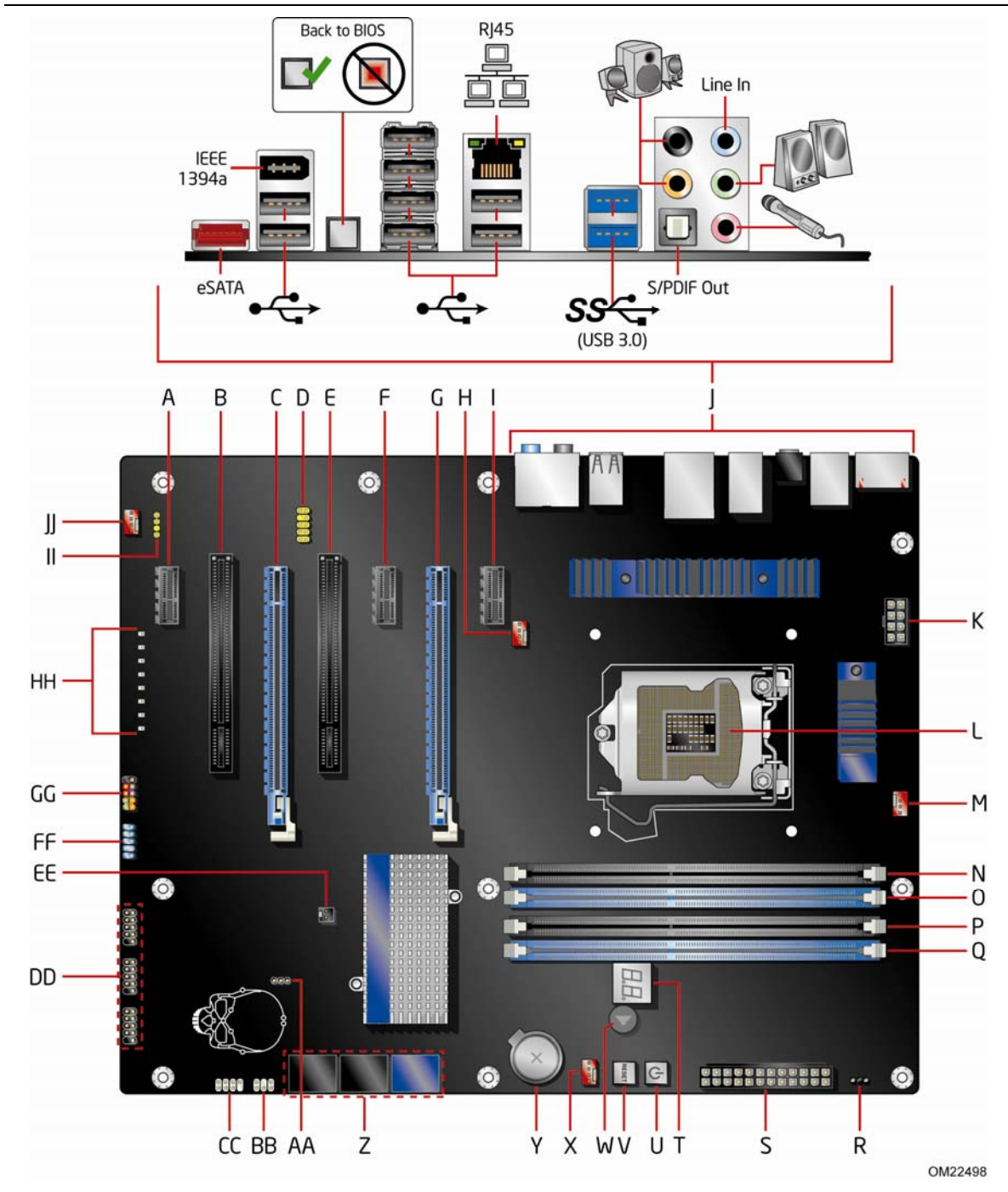

OM22498

Figure 1. Intel Desktop Board DZ68ZV Components

Table 2. Intel Desktop Board DZ68ZV Components

Label	Description
A	PCI Express 2.0 x1 connector
B	PCI bus connector
C	PCI Express 2.0 x16 connector (x8 electrical; x16 compatible)
D	Front panel audio header
E	PCI bus connector
F	PCI Express 2.0 x1 connector
G	PCI Express 2.0 x16 connector
H	Rear chassis fan header
I	PCI Express 2.0 x1 connector
J	Back panel connectors
K	12 V processor core voltage connector (2 x 4 pin)
L	Processor socket
M	Processor fan header
N	DIMM 3 socket
O	DIMM 1 socket
P	DIMM 4 socket
Q	DIMM 2 socket
R	Alternate front panel power LED header
S	Main power connector (2 x 12 pin)
T	POST code LED display
U	Onboard reset button
V	Onboard power button
W	Speaker
X	Front chassis fan header
Y	Battery
Z	Serial ATA (SATA) connectors
AA	BIOS configuration jumper block
BB	Back panel CIR transmitter (output) header
CC	Front panel CIR receiver (input) header
DD	USB 2.0 headers
EE	Chassis intrusion header
FF	IEEE 1394a header
GG	Front panel header
HH	Diagnostic LEDs
II	S/PDIF header
JJ	Auxiliary chassis fan header

Online Support

For more information on Intel Desktop Board DZ68ZV consult the following online resources:

- Intel Desktop Board DZ68ZV <http://www.intel.com/products/motherboard/index.htm>
- Desktop Board Support http://www.intel.com/p/en_US/support?iid=hdr+support
- Available configurations for Intel Desktop Board DZ68ZV <http://ark.intel.com>
- Supported processors <http://processormatch.intel.com>
- Chipset information <http://www.intel.com/products/desktop/chipsets/index.htm>
- BIOS and driver updates <http://downloadcenter.intel.com/>
- Integration information <http://www.intel.com/support/go/buildit>

Processor



CAUTION

Failure to use an appropriate power supply and/or not connecting the 12 V (2 x 4 pin) power connector to the Desktop Board may result in damage to the board, or the system may not function properly.

Intel Desktop Board DZ68ZV supports an Intel processor in the LGA1155 package. Processors are not included with the Desktop Board and must be purchased separately. The processor connects to the Desktop Board through the LGA1155 socket.

For information on supported processors for Intel Desktop Board DZ68ZV, go to <http://processormatch.intel.com>.

Main Memory



NOTE

To be fully compliant with all applicable Intel® SDRAM memory specifications, the board should be populated with DIMMs that support the Serial Presence Detect (SPD) data structure. If your memory modules do not support SPD, you will see a notification to this effect on the screen at power up. The BIOS will attempt to configure the memory controller for normal operation.

The Desktop Board supports the following memory and interface:

- Four 240-pin Double Data Rate 3 (DDR3) SDRAM Dual Inline Memory Module (DIMM) sockets with gold-plated contacts arranged in two channels
- 2133 MHz to 1066 MHz DDR3 SDRAM Memory Modules
- Support for single- and dual-channel memory interleaving
- Unbuffered, non-registered single- or double-sided DIMMs with a voltage rating of 1.65 V or less



NOTE

Using a DIMM with a voltage rating higher than 1.65 V may damage the processor.

- Non-ECC DDR3 memory
- Serial Presence Detect (SPD) memory only
- Up to 32 GB maximum total system memory using 8 GB DIMMs



NOTE

32-bit operating systems are limited to a maximum of 4 GB of memory. These operating systems will report less than 4 GB because of the memory used by add-in graphics cards and other system resources.

Intel® Z68 Express Chipset

The Intel Z68 Express Chipset consists of the Intel Z68 Platform Controller Hub (PCH). The PCH is the centralized controller for the board's I/O paths.

The Intel Z68 PCH provides Intel RST support including Intel RRT and Intel Smart Response Technology.

Intel® RST

The Intel RST software package provides high-performance SATA and SATA RAID capabilities for supported operating systems. Intel RST version 10.6 enables Intel Smart Response Technology, the full SATA interface speed up to 6 Gb/s, and Intel RRT to support next-generation Solid State Drives (SSDs) or traditional Hard Disk Drives (HDDs). Intel RST version 10.6 also includes support for larger than 2.2 TB HDDs in a RAID configuration.

Intel® RRT

Intel RRT uses RAID 1 (mirroring) functionality to copy data from a designated master drive to a designated recovery drive. The master drive data can be copied to the recovery drive either continuously or on request:

- Continuous: Changes made to data on the master drive while the system is not docked are automatically copied to the recovery drive when the system is re-docked.
- On request: The master drive data is restored to a previous state by copying the data on the recovery drive back to the master drive.

Intel® Smart Response Technology

Intel Smart Response Technology supports a single drive volume that combines the high-performance benefits of SSDs with the large storage capacities of traditional HDDs to dramatically increase system responsiveness and enable faster boot times. The two technologies (SSD and HDD) appear as a single C:\ drive letter that provides you with the familiar storage identifier.

The system automatically learns which files you access frequently and then copies them from the HDD to the SSD. The next time you request these files, the system loads them from the fast SSD rather than the slower HDD. For infrequently-used files, the system loads them from the HDD when you need them.



NOTE

The SATA Drive Mode must be set to RAID in the BIOS Setup in order for your system to use Intel Smart Response Technology. Once RAID is enabled, you can install the operating system and the Intel Rapid Storage Technology driver. If the operating system was already installed with the SATA Drive Mode set to AHCI, you must reinstall the operating system with the SATA Drive Mode set to RAID. Refer to Section 4, "Configuring Intel Smart Response Technology and RAID Using Intel® RST", on 71 for more information.

For more information on Intel Smart Response Technology refer to <http://download.intel.com/design/flash/nand/325554.pdf> or download the *Intel Smart Response Technology User Guide* at [http://www.intel.com/support/motherboards/desktop/dz68db/sb/CS-032499.htm?wapkw=\(smart+response\)](http://www.intel.com/support/motherboards/desktop/dz68db/sb/CS-032499.htm?wapkw=(smart+response))

Audio Subsystem

The onboard audio subsystem consists of the following components:

- Intel® Z68 PCH
- Realtek ALC892 codec

The subsystem has the following headers and connectors:

- Back panel audio connectors, including an S/PDIF out optical port.
- Advanced jack sense for the back panel audio connectors that enables the audio codec to recognize the device that is connected to an audio port
- High Definition Audio Front panel audio header that supports Intel HD Audio and AC '97 Audio. This header provides mic in and line out signals for front panel audio connectors.
- An onboard S/PDIF header

The audio subsystem supports the following features:

- A signal-to-noise (S/N) ratio of 97 dB
- Independent multi-streaming 8-channel (7.1) audio (using the back panel audio connectors) and 2-channel audio (using the High Definition Audio front panel header)

Table 3 lists the supported functions of front panel and back panel audio jacks.

Table 3. Audio Jack Retasking Support

Audio Jack	Micro-phone	Head-phones	Front Speakers	Line In	Side Surround	Rear Surround	Center/ Subwoofer
FP Green		Default					
FP Pink	Default						
BP Blue				Default			
BP Green		Control panel	Default				
BP Pink	Default				Default		
BP Black						Default	
BP Orange							Default

LAN Subsystem

The LAN subsystem includes:

- Intel Z68 PCH
- Intel 82579V Gigabit (10/100/1000 Mb/s) Ethernet LAN controller
- RJ-45 LAN connector with integrated status LEDs

The subsystem features:

- CSMA/CD protocol engine
- LAN connect interface between PCH and the LAN controller
- PCI bus power management

Two LEDs are built into the RJ-45 LAN connector located on the back panel (see Figure 2). These LEDs indicate the status of the LAN as shown in Table 4.

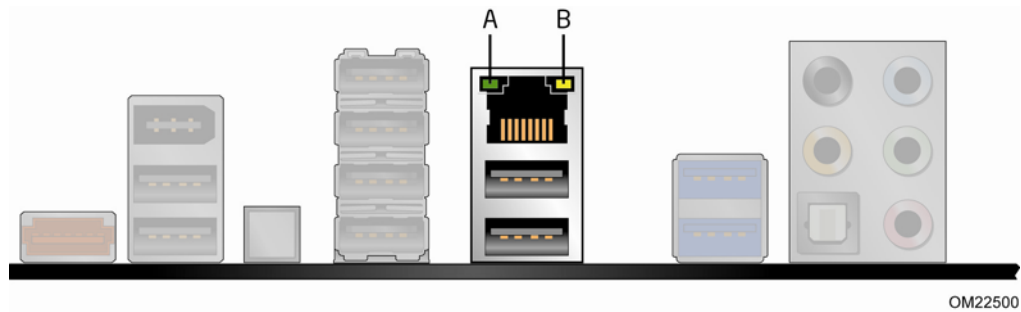

OM22500

Figure 2. LAN Connector LEDs

Table 4. LAN Connector LEDs

LED	LED Color	LED State	Indicates
A	Green	Off	LAN link is not established
		On	LAN link is established
		Blinking	LAN activity is occurring
B	N/A	Off	10 Mb/s data rate
	Green	On	100 Mb/s data rate
	Yellow	On	1000 Mb/s data rate

USB Support

The Desktop Board supports USB 2.0 and USB 3.0. There are 14 USB 2.0 ports (eight ports routed to back panel connectors and six ports routed to three onboard headers). The USB 2.0 ports are high-speed, full-speed, and low-speed capable.

USB 3.0 is supported by two back panel connectors (blue). USB 3.0 ports are backward compatible with USB 2.0 and USB 1.1 devices. The USB 3.0 ports are SuperSpeed, high-speed, full-speed, and low-speed capable.

Serial ATA Support

Intel Desktop Board DZ68ZV supports two onboard 6.0 Gb/s Serial ATA (SATA) channels and four onboard 3.0 Gb/s SATA channels. The board also provides one 3.0 Gb/s external SATA (eSATA) channel via a back panel connector.

The onboard SATA channels provided by the PCH support Intel Rapid Storage Technology which provides the following RAID (Redundant Array of Independent Drives) levels:

- RAID 0 - data striping
- RAID 1 - data mirroring
- RAID 0+1 (or RAID 10) - data striping and data mirroring
- RAID 5 - distributed parity

Legacy I/O

Intel Desktop Board DZ68ZV includes a legacy I/O controller that provides the following I/O features:

- Consumer Infrared (CIR) support
- Low pin count (LPC) interface
- Intelligent power management, including a programmable wake up event interface
- PCI power management support

Expandability

Intel Desktop Board DZ68ZV provides the following expansion capability:

- One PCI Express 2.0 x16 port
- One PCI Express 2.0 x8 port (x8 electrical; x16 compatible)
- Three PCI Express 2.0 x1 ports
- Two PCI bus connectors

Bluetooth* /WiFi Support

Intel Desktop Board DZ68ZV ships with an external Bluetooth*/WiFi module that allows you to connect to wireless networks and Bluetooth peripherals. For instructions on how to install the Bluetooth/WiFi module in a desktop chassis, refer to "Installing the WiFi/Bluetooth Module in a Desktop Chassis (optional)" on page 65.

Bluetooth Technology

The Bluetooth/WiFi Module enables you to connect with a variety of Bluetooth-enabled devices. Driver support is provided by Microsoft operating systems such as Microsoft Vista and Microsoft Windows 7. The Bluetooth driver stack is supplied by Microsoft but some Bluetooth enabled devices might provide additional Bluetooth features and for proper functioning of those features, will need their own supplied drivers installed.

- CSR Bluetooth module (BC0401PC08)
- Maximum data rate 3.0 Mb/s
- Forward and backward compatibility with Bluetooth v1.1, v1.2, v2.0, and v2.1
- Integrated antenna
- Operating system support (Windows XP, Windows Vista, and Windows 7 both 32 bit and 64 bit)

To obtain more Bluetooth information and drivers go to [http://msdn.microsoft.com/en-us/library/aa362932\(VS.85\).aspx](http://msdn.microsoft.com/en-us/library/aa362932(VS.85).aspx)

WiFi 802.11 Wireless

The Bluetooth/WiFi Module also enables you to connect with a variety of WiFi enabled networks and access points and also allows peer to peer connections. Driver support is provided by Microsoft operating systems such as Microsoft Vista and Microsoft Windows 7 with additional support provided by the supplied WiFi driver included on the Driver DVD and online.

- Ralink WiFi 802.11 (RT8070)
- Range up to 300 meters
- Supports the following:
 - IEEE 802.11B supports up to 11 Mb/s data rate
 - IEEE 802.11G supports up to 54 Mb/s data rate
 - IEEE 802.11N supports up to 150 Mb/s data rate
- Integrated Antenna
- Operating system support (Windows XP, Windows Vista, and Windows 7 both 32 bit and 64 bit)

To obtain more WiFi information and drivers go to [http://msdn.microsoft.com/en-us/library/aa362932\(VS.85\).aspx](http://msdn.microsoft.com/en-us/library/aa362932(VS.85).aspx)

BIOS

The BIOS provides the Power-On Self-Test (POST), the BIOS Setup program, and the PCI/PCI Express and SATA auto-configuration utilities. The BIOS is stored in the Serial Peripheral Interface (SPI) Flash device.

The BIOS can be updated by following the instructions in Chapter 3 starting on page 67.

Serial ATA Auto Configuration

If you install a Serial ATA device (such as a hard drive) in your computer, the auto-configuration utility in the BIOS automatically detects and configures the device for your computer. You do not need to run the BIOS Setup program after installing a Serial ATA. You can override the auto-configuration options by specifying manual configuration in the BIOS Setup program.

PCI* and PCI Express* Auto Configuration

If you install a PCI/PCI Express add-in card in your computer, the PCI/PCI Express auto-configuration utility in the BIOS automatically detects and configures the resources (IRQs, DMA channels, and I/O space) for that add-in card. You do not need to run the BIOS Setup program after you install a PCI/PCI Express add-in card.

Security Passwords

The BIOS includes security features that restrict whether the BIOS Setup program can be accessed and who can boot the computer. A supervisor password and a user password can be set for the BIOS Setup and for booting the computer, with the following restrictions:

- The supervisor password gives unrestricted access to view and change all Setup options. If only the supervisor password is set, pressing <Enter> at the password prompt of Setup gives the user restricted access to Setup.
- If both the supervisor and user passwords are set, you must enter either the supervisor password or the user password to access Setup. Setup options are then available for viewing and changing depending on whether the supervisor or user password was entered.
- Setting a user password restricts who can boot the computer. The password prompt is displayed before the computer is booted. If only the supervisor password is set, the computer boots without asking for a password. If both passwords are set, you can enter either password to boot the computer.

Related Links:

For instructions on resetting the password, go to Clearing Passwords on page 58.

Back to BIOS Button

The back panel Back to BIOS button (Figure 3, A) duplicates the functionality of the BIOS configuration jumper (see Setting the BIOS Configuration Jumper on page 57) with the following exceptions:

- It can only be used to force the board to power on to the BIOS Maintenance Menu using default values but it will retain all previously saved changes.
- It cannot be used to override passwords set in the BIOS.
- It cannot be used to invoke BIOS recovery mode.

The button glows red when it is activated.



NOTE

Using the Back to BIOS button does not set the board to the factory BIOS defaults. To restore settings to the factory defaults, use the <F9> key once BIOS setup mode is active.

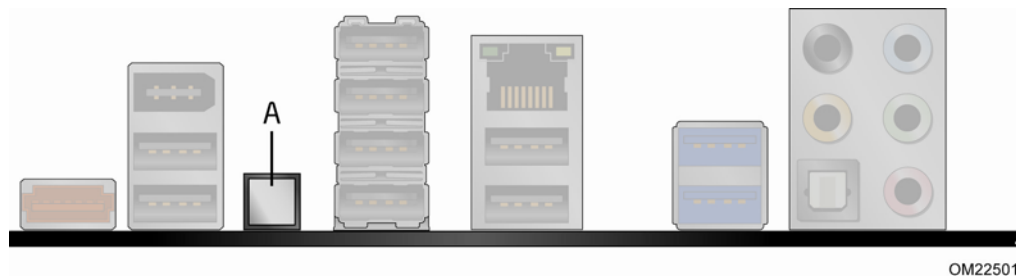

Figure 3. Location of the Back to BIOS Button

Hardware Management

The hardware management features of Intel Desktop Board DZ68ZV enable the board to be compatible with the Wired for Management (WfM) specification. The board has several hardware management features including the following:

- Fan speed monitoring and control
- Thermal and voltage monitoring
- Chassis intrusion detection

Hardware Monitoring and Fan Speed Control

The features of the hardware monitoring and fan speed control include:

- Monitoring of power supply voltages to detect levels above and below acceptable values
- Smart fan control provided by the legacy I/O controller, delivering acoustically-optimized thermal management. Fan speed controllers and sensors are integrated into the legacy I/O controller.
- A thermal sensor in the processor
- Thermally monitored closed-loop fan control, for all onboard fans, that can adjust fan speed

Chassis Intrusion

The board supports a chassis security feature that detects if the chassis cover has been removed. The security feature uses a mechanical switch on the chassis that can be connected to the chassis intrusion header on the Desktop Board. See Figure 24 for the location of the chassis intrusion header.

Power Management

Power management is implemented at several levels, including software support through the Advanced Configuration and Power Interface (ACPI) and the following hardware support:

- Power connectors
- Fan headers
- LAN wake capabilities
- Instantly Available PC technology (Suspend to RAM)
- Wake from USB
- Power Management Event signal (PME#) wakeup support
- WAKE# signal wake-up support
- Wake from Consumer IR

Software Support

ACPI

ACPI gives the operating system direct control over the power management and Plug and Play functions of a computer. The use of ACPI with the Desktop Board requires an operating system that provides full ACPI support.

Hardware Support

Power Connectors

ATX12V-compliant power supplies can turn off the computer power through system control. When an ACPI-enabled computer receives the correct command, the power supply removes all non-standby voltages.

When resuming from an AC power failure, the computer returns to the power state it was in before power was interrupted (either on or off). The computer's response can be set by using the Last Power State feature in the BIOS Setup program's Boot menu.

The Desktop Board has three power connectors. See Figure 27 on page 56 for the location of the power connectors.

Fan Headers

The function/operation of the fans is as follows:

- The fans are on when the computer is in the ACPI S0 state.
- The fans are off when the computer is in the ACPI S3, S4, or S5 state.
- Each fan header is wired to a tachometer input of the hardware monitoring and control device.
- All fan headers support closed-loop fan control that can adjust the fan speed or switch the fan on or off as needed.
- All fan headers have a +12 V DC connection.

The Desktop Board has a 4-pin processor fan header and three 4-pin chassis fan headers.

LAN Wake Capabilities



CAUTION

For LAN wake capabilities, the 5 V standby line for the power supply must be capable of delivering adequate +5 V standby current. Failure to provide adequate standby current when using this feature can damage the power supply.

LAN wakeup capabilities enable remote wake-up of the computer through a network. The LAN subsystem monitors network traffic and upon detecting a Magic Packet* frame, it asserts a wake-up signal that powers up the computer.

Instantly Available PC Technology



CAUTIONS

For Instantly Available PC technology, the 5 V standby line for the power supply must be capable of delivering adequate +5 V standby current. Failure to provide adequate standby current when using this feature can damage the power supply and/or effect ACPI S3 sleep state functionality.

Power supplies used with this Desktop Board must be able to provide enough standby current to support the standard Instantly Available (ACPI S3 sleep state) configuration. If the standby current necessary to support multiple wake events from the PCI and/or USB buses exceeds power supply capacity, the Desktop Board may lose register settings stored in memory.

Instantly Available PC technology enables the board to enter the ACPI S3 (Suspend-to-RAM) sleep state. While in the S3 sleep state, the computer will appear to be off. If the computer has a dual-colored power LED on the front panel, the sleep state is indicated by the LED turning amber. When signaled by a wake-up device or event, the computer quickly returns to its last known awake state.

The Desktop Board supports the *PCI Bus Power Management Interface Specification*. Add-in cards that support this specification can participate in power management and can be used to wake the computer.

Wake from USB



NOTE

Wake from USB requires the use of a USB peripheral that supports Wake from USB and an operating system that supports Wake from USB.

USB bus activity wakes the computer from an ACPI S3 state.

PME# Signal Wake-up Support

When the PME# signal on the PCI bus is asserted, the computer wakes from an ACPI S3, S4, or S5 state.

WAKE# Signal Wake-up Support

When the WAKE# signal on the PCI Express bus is asserted, the computer wakes from an ACPI S3, S4, or S5 state.

Wake from Consumer IR

Consumer IR device activity wakes the computer from an ACPI S3, S4, or S5 state.

Onboard Power and Reset Buttons

The lighted Power button on the Desktop Board (Figure 4, B) can be used to turn the computer on or off. This button duplicates the function of the front panel power button. To turn off the computer using the onboard Power button, press it for three seconds.

The Power button stays lit when there is standby power still present on the board. This is the case even when the computer appears to be off. For example, when this button is lit, standby power is still present at the memory module sockets and the PCI bus connectors.



CAUTION

If the AC power has been switched off and the onboard power button is still lit, disconnect the power cord before installing or removing any devices connected to the board. Failure to do so could damage the board and any attached devices.

The lighted Reset button on the Desktop Board (Figure 4, A) can be used to reset the board. This button duplicates the function of the front panel Reset button.

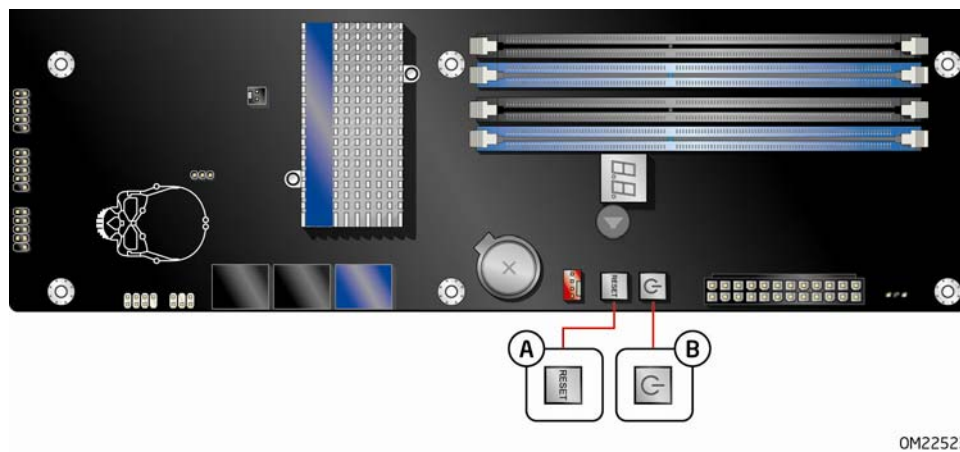

OM22523

Figure 4. Onboard Power and Reset Buttons

Processor and Voltage Regulator LEDs

The Desktop Board contains two red LEDs (see Figure 5) that indicate the status of the board's voltage regulation circuitry and the processor:

- The Processor LED (Figure 5, B) indicates an elevated temperature on the processor that could affect performance.
- The Voltage Regulator LED (Figure 5, A) indicates an elevated temperature in the processor voltage regulator circuit that could affect performance.

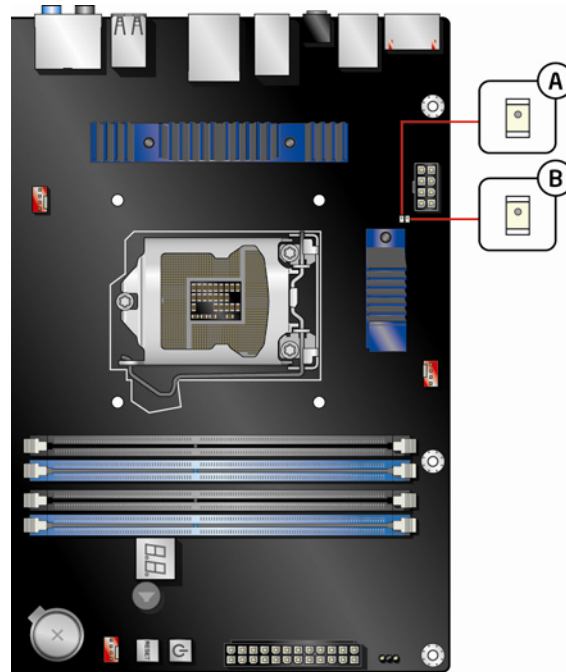

OM22497

Figure 5. Location of the Processor and Voltage Regulator LEDs

Diagnostic LEDs

The Desktop Board provides eight LEDs that allow you to monitor the board's progress through the BIOS Power-on Self-Test (see Figure 6). At initial power on, all the LEDs are off. When the BIOS starts an activity such as memory initialization, the corresponding LED starts flashing. Once the activity has completed, the LED will remain on.

Table 5. Diagnostic LEDs

Item/Callout in Figure 6	Activity	LED Color	Description
A	Watch Dog Timer Fire/ Back to BIOS	Red	When the watch dog timer fires to reset the board, this LED will flash. In addition, this LED will light and stay on when the Back to BIOS button has been pressed.
B	Processor Initialization	Green	This LED will flash when the processor initialization activity starts. Then the LED will stay on when processor initialization is complete.
C	Memory Initialization	Green	This LED will flash when the memory initialization activity starts. Then the LED will stay on when memory initialization is complete.
D	Video Initialization	Green	This LED will flash when the video initialization activity starts. Then the LED will stay on when video initialization is complete.
E	USB Initialization	Green	This LED will flash when the USB initialization activity starts. Then the LED will stay on when USB initialization is complete.
F	Hard Drive Initialization	Green	This LED will flash when the hard drive activity starts. Then the LED will stay on when hard drive initialization is complete.
G	Option ROM Initialization	Green	This LED will flash when the option ROM activity starts. Then the LED will stay on when option ROM initialization is complete.
H	OS Start	Green	Just before BIOS transfers control to the operating system, this LED will light and stay on.

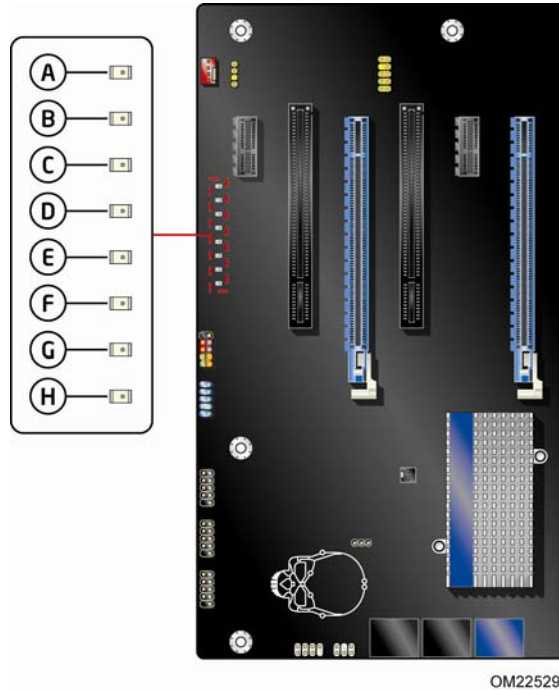

Figure 6. Location of the Diagnostic LEDs

Speaker

A speaker is mounted on the Desktop Board. The speaker provides audible error code (beep code) information during the Power-On Self-Test (POST). Refer to Appendix A for a description of the board's beep codes.

Battery

A battery on the Desktop Board keeps the values in CMOS RAM and the clock current when the computer is turned off. Go to page 59 for instructions on how to replace the battery.

Real-Time Clock

The Desktop Board has a time-of-day clock and 100-year calendar. The battery on the Desktop Board keeps the clock current when the computer is turned off.

2 Installing and Replacing Desktop Board Components

This chapter tells you how to:

- Install the I/O shield
- Install and remove the Desktop Board
- Install and remove a processor
- Install and remove memory
- Install and remove a PCI Express x16 graphics card
- Connect the Serial ATA cables
- Connect to the internal headers
- Connect to the audio system
- Connect chassis fan and power supply cables
- Set the BIOS configuration jumper
- Clear passwords
- Replace the battery
- Install the WiFi/BlueTooth Module

Before You Begin



CAUTIONS

The procedures in this chapter assume familiarity with the general terminology associated with personal computers and with the safety practices and regulatory compliance required for using and modifying electronic equipment.

Disconnect the computer from its power source and from any telecommunications links, networks, or modems before performing any of the procedures described in this chapter. Failure to disconnect power, telecommunications links, networks, or modems before you open the computer or perform any procedures can result in personal injury or equipment damage. Some circuitry on the board can continue to operate even though the front panel power button is off.

Follow these guidelines before you begin:

- Always follow the steps in each procedure in the correct order.
- Set up a log to record information about your computer, such as model, serial numbers, installed options, and configuration information.
- Electrostatic discharge (ESD) can damage components. Perform the procedures described in this chapter only at an ESD workstation using an antistatic wrist strap and a conductive foam pad. If such a station is not available, you can provide some ESD protection by wearing an antistatic wrist strap and attaching it to a metal part of the computer chassis.

Installation Precautions

When you install and test the Intel Desktop Board, observe all warnings and cautions in the installation instructions.

To avoid injury, be careful of:

- Sharp pins on connectors
- Sharp pins on printed circuit assemblies
- Rough edges and sharp corners on the chassis
- Hot components (such as processors, voltage regulators, and heat sinks)
- Damage to wires that could cause a short circuit

Observe all warnings and cautions that instruct you to refer computer servicing to qualified technical personnel.

Prevent Power Supply Overload

Do not overload the power supply output. To avoid overloading the power supply, make sure that the calculated total current loads of all the modules within the computer is less than the output current rating of each of the power supplies output circuits.

Observe Safety and Regulatory Requirements

Read and follow the instructions in this section and the instructions supplied with the chassis and associated modules. If you do not follow these instructions and the instructions provided by the chassis and module suppliers, you increase your safety risk and the possibility of noncompliance with regional laws and regulations. If the instructions for the chassis are inconsistent with these instructions or the instructions for associated modules, contact the supplier to find out how you can ensure that your computer meets safety and regulatory requirements.

For information about the Desktop Board's regulatory compliance, refer to Appendix B.

Installing the I/O Shield

The Desktop Board comes with an I/O shield. When installed in the chassis, the shield blocks radio frequency transmissions, protects internal components from dust and foreign objects, and promotes correct airflow within the chassis.

Install the I/O shield before installing the Desktop Board in the chassis. Place the shield inside the chassis as shown in Figure 7. Press the shield into place so that it fits tightly and securely. If the shield does not fit, obtain a properly sized shield from the chassis supplier.

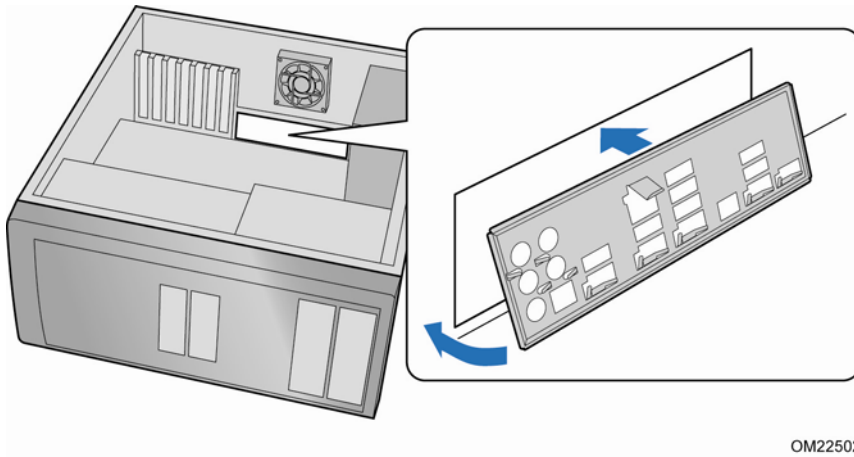

OM22502

Figure 7. Installing the I/O Shield

Installing and Removing the Desktop Board



CAUTION

Only qualified technical personnel should perform this procedure. Disconnect the computer from its power source before performing the procedures described here. Failure to disconnect the power before you open the computer can result in personal injury or equipment damage.

Refer to your chassis manual for instructions on installing and removing the Desktop Board.

Figure 8 shows the location of the mounting screw holes for Intel Desktop Board DZ68ZV.

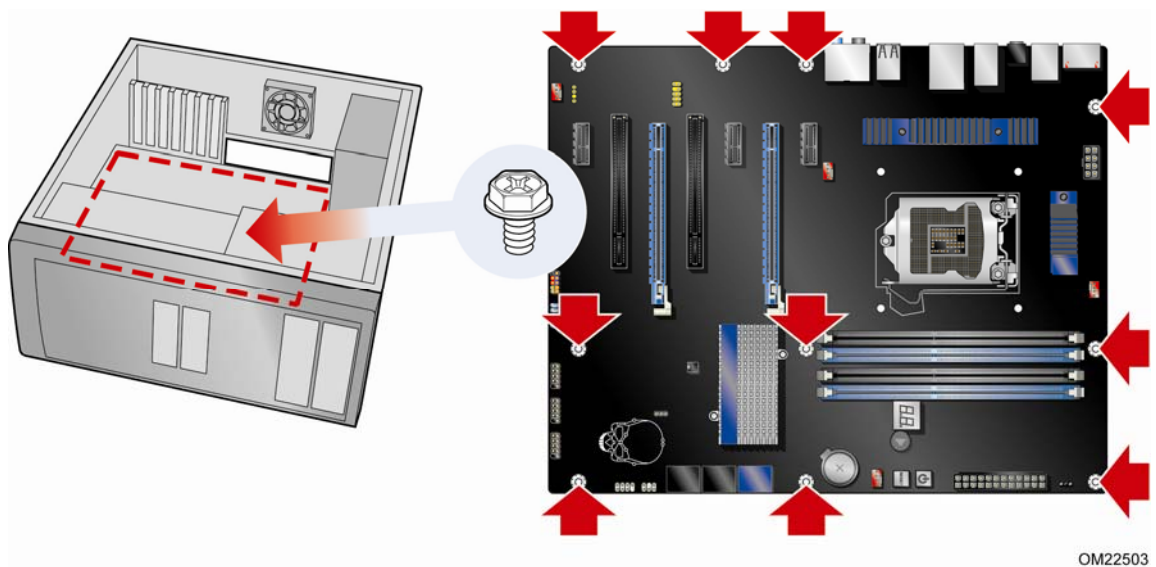

Figure 8. Intel Desktop Board DZ68ZV Mounting Screw Hole Locations

Installing and Removing a Processor

Instructions on how to install the processor on the Desktop Board are given below.

Installing a Processor



CAUTION

Before installing or removing a processor, make sure the AC power has been removed by unplugging the power cord from the computer. Failure to do so could damage the processor and the board.

To install a processor, follow these instructions:

1. Observe the precautions in "Before You Begin" on page 31.
2. Unlatch the processor socket lever by pushing it down and away from the socket (Figure 9, A, B).

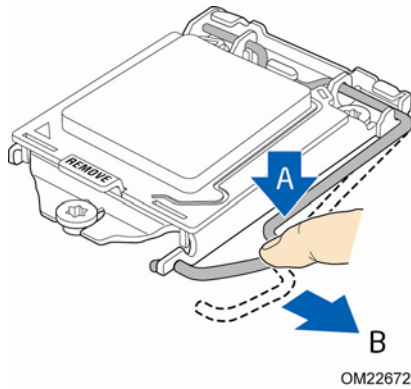
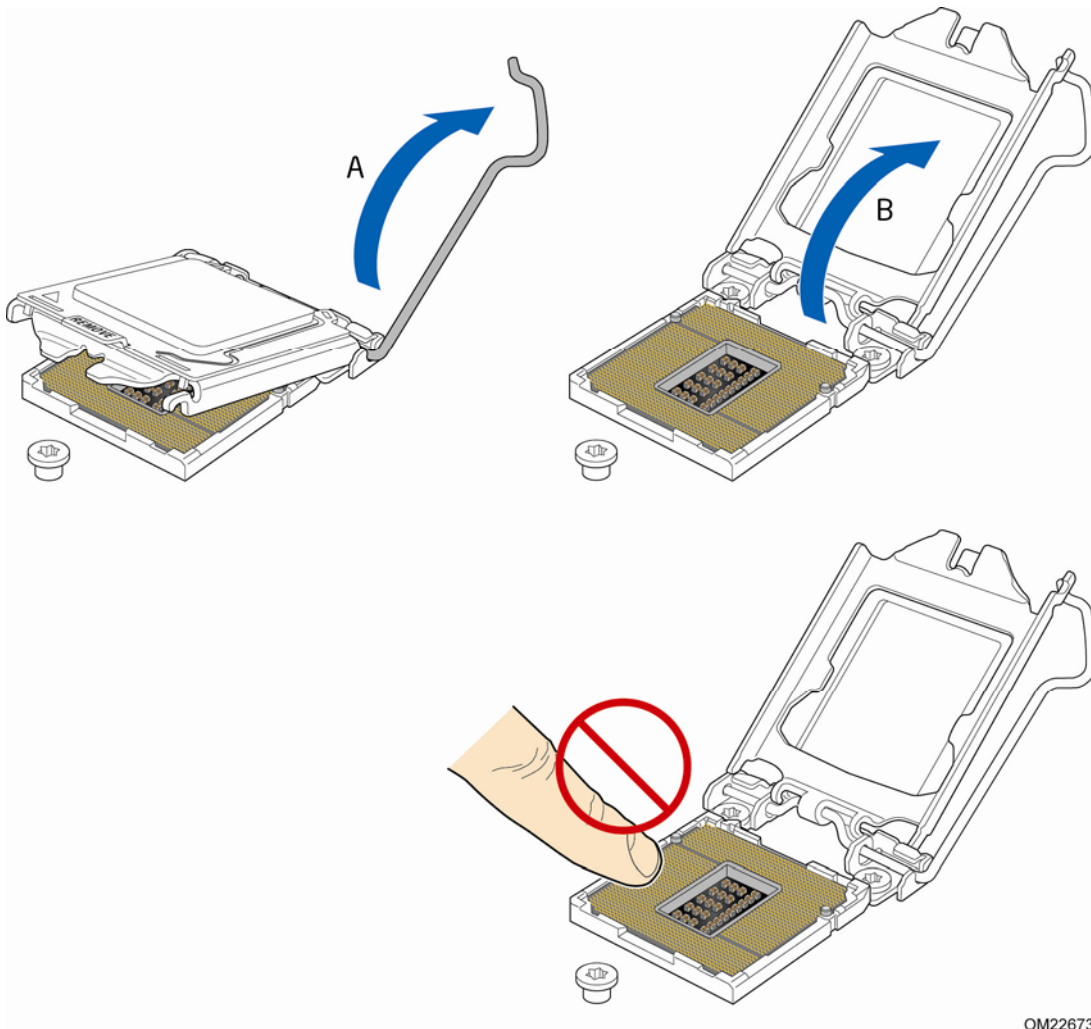

Figure 9. Unlatch the Socket Lever

3. Rotate the socket lever to lift the load plate away from the socket (Figure 10, A). Make sure that the load plate is in the fully open position (Figure 10, B) while being careful not to damage adjacent components. Do not touch the socket contacts.



OM22673

Figure 10. Lift the Load Plate

4. Remove the processor from its protective cover. Hold the processor only at the edges, being careful not to touch the bottom of the processor (see Figure 11).



NOTE

Do not discard the processor cover. Always replace the processor cover if you remove the processor from the socket.

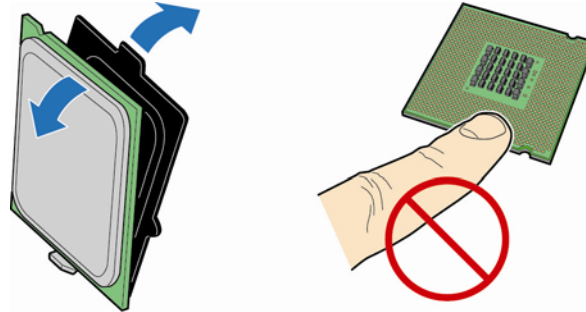

OM22674

Figure 11. Remove the Processor from the Protective Cover

5. Hold the processor with your thumb and index finger oriented as shown in Figure 12 to align your fingers with the socket finger cutouts. Make sure that the processor Pin 1 indicator (gold triangle) is aligned with the Pin 1 chamfer on the socket (Figure 12, B) and that the notches on the processor align with the posts on the socket (Figure 12, C). Lower the processor straight down without tilting or sliding it in the socket (Figure 12, A).

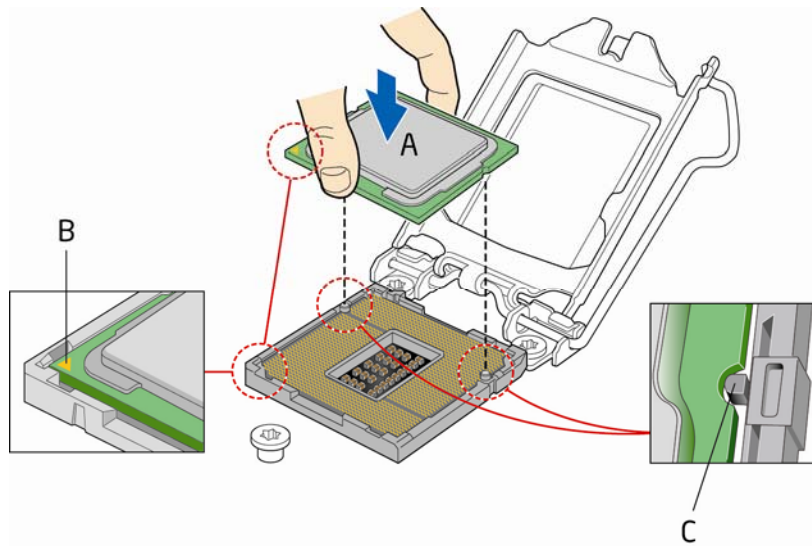

OM22675

Figure 12. Install the Processor

- Carefully lower the socket lever (Figure 13, A) while making sure that the front edge of the load plate slides under the shoulder screw cap as the lever is lowered. Latch the socket lever under the load plate tab (Figure 13, C, D). The socket cover (Figure 13, B) will pop off as shown.

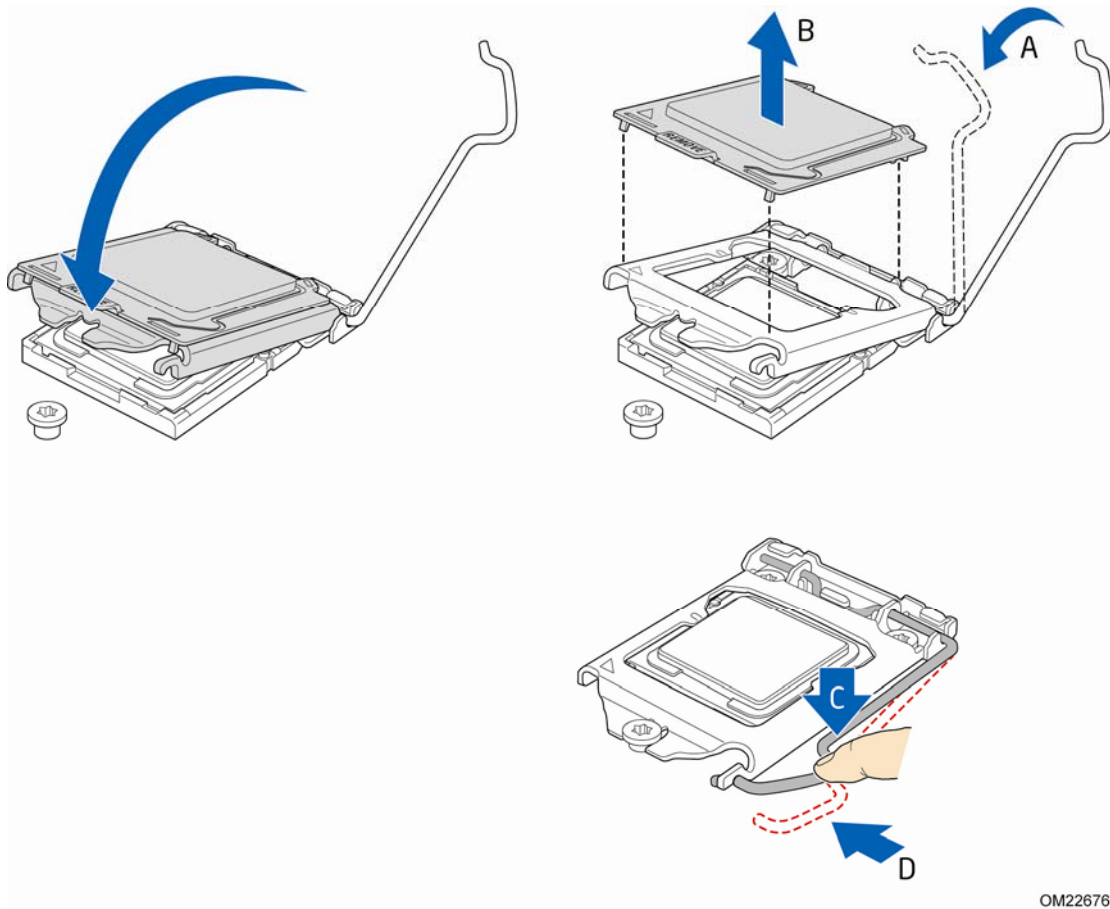

Figure 13. Secure the Load Plate in Place

- Pick up the socket cover and remove it from the desktop board.



NOTE

Do not discard the socket cover; save it for possible future use. Always replace the socket cover if you remove the processor from the socket.

Installing the Processor Fan Heat Sink

Intel Desktop Board DZ68ZV has mounting holes for a processor fan heat sink. For instructions on how to attach the processor fan heat sink to the Desktop Board, refer to the boxed processor manual or boxed thermal solution manual.

Connecting the Processor Fan Heat Sink Cable

Connect the processor fan heat sink power cable to the 4-pin processor fan header (see Figure 17). A fan with a 4-pin connector as shown in Figure 17 is recommended.

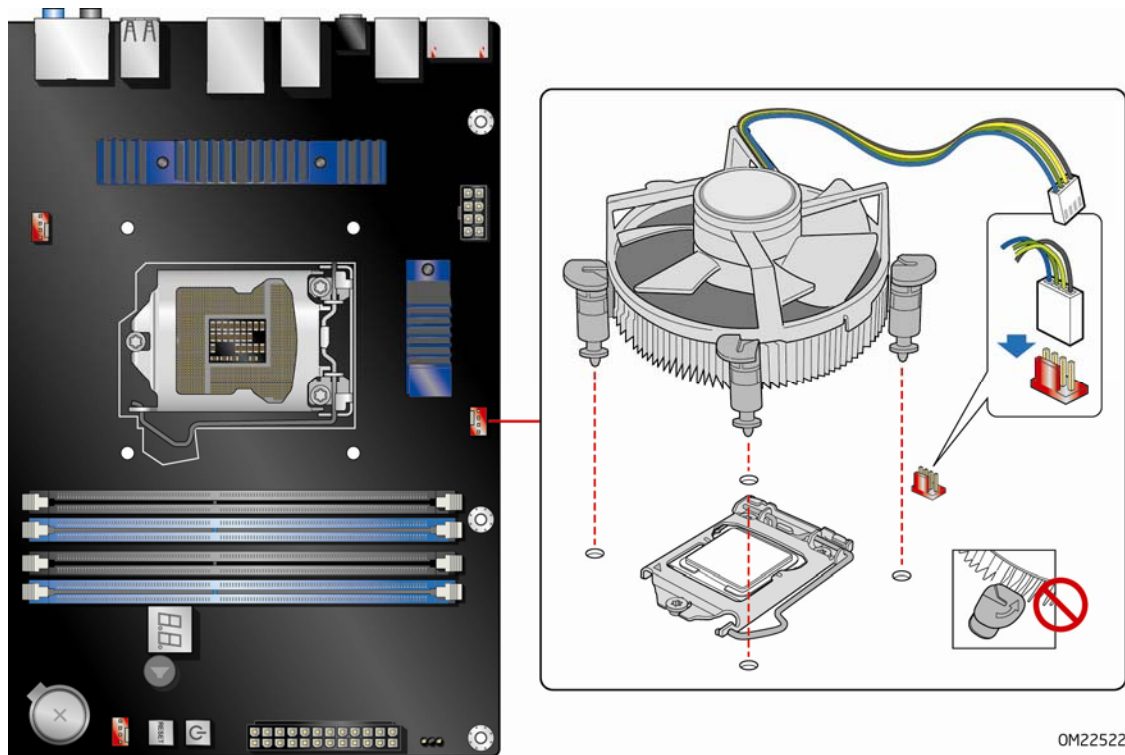

Figure 14. Connecting the Processor Fan Heat Sink Power Cable to the Processor Fan Header

Removing the Processor

For instructions on how to remove the processor fan heat sink and processor, refer to the processor installation manual.

Installing and Removing System Memory

Desktop board DZ68ZV has four 240-pin DDR3 DIMM sockets arranged in two channels (A and B).

Guidelines for Dual Channel Memory Configuration

Before installing DIMMs, read and follow these guidelines for dual channel memory configuration.

Two or Four DIMMs

Install a matched pair of DIMMs equal in speed and size (see Figure 15) in the blue socket of channel A (DIMM 1) and channel B (DIMM 2).

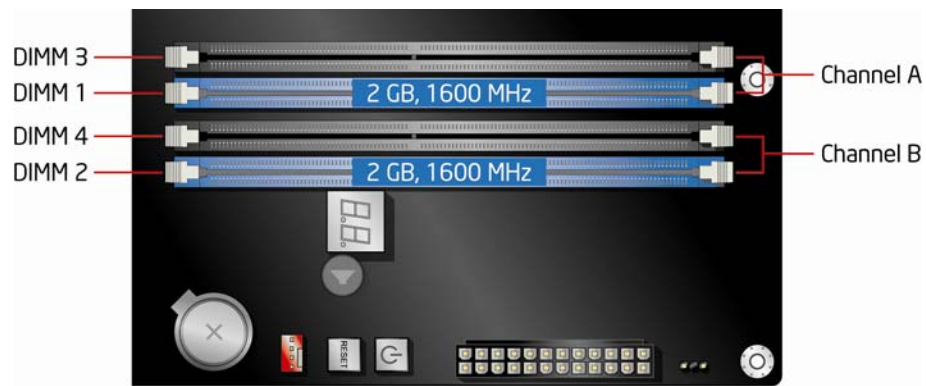

0M22528

Figure 15. Example Dual Channel Memory Configuration with Two DIMMs

If additional memory is to be used, install another matched pair of DIMMs (see Figure 16) in the black socket of channel A (DIMM 3) and channel B (DIMM 4).

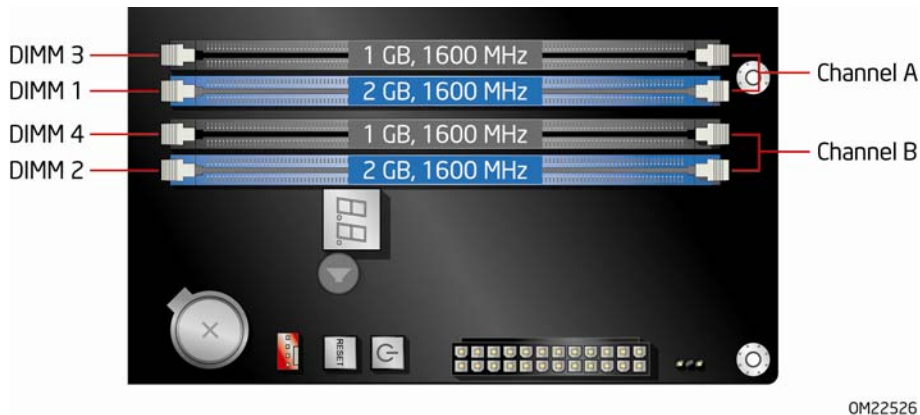

Figure 16. Example Dual Channel Memory Configuration with Four DIMMs

Three DIMMs

If you want to use three DIMMs in a dual-channel configuration, install a matched pair of DIMMs equal in speed and size in DIMM 1 and DIMM 3 of channel A. Then install another DIMM equal to the speed and total size of the DIMMs installed in channel A in either DIMM 2 or DIMM 4 of channel B (Figure 17).

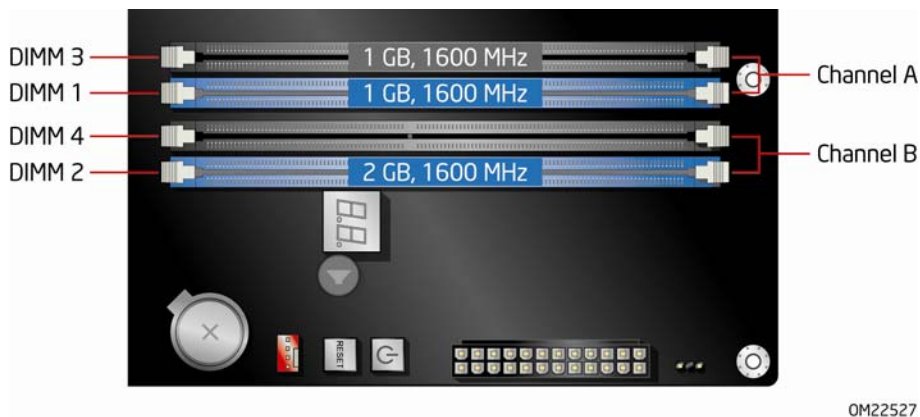

Figure 17. Example Dual Channel Memory Configuration with Three DIMMs



NOTE

All other memory configurations will result in single channel memory operation.

Installing DIMMs

To make sure you have the correct DIMM, place it on the illustration of the DDR3 DIMM in Figure 18. All the notches should match with the DDR3 DIMM.

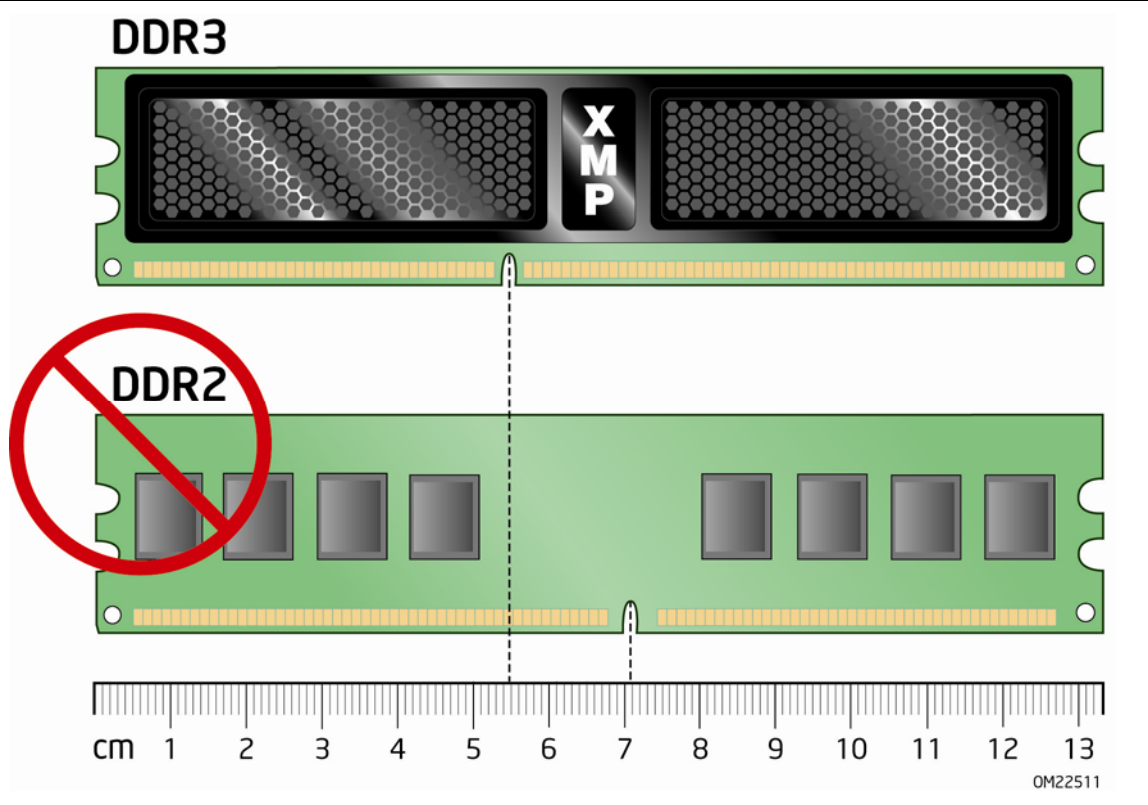

Figure 18. Use DDR3 DIMMs



NOTE

For best memory performance, install memory in the blue DIMM sockets first.

To install a DIMM, follow these steps:

1. Observe the precautions in "Before You Begin" on page 31.
2. Turn off all peripheral devices connected to the computer. Turn off the computer and disconnect the AC power cord.
3. Remove the computer's cover and locate the DIMM sockets (see Figure 19).

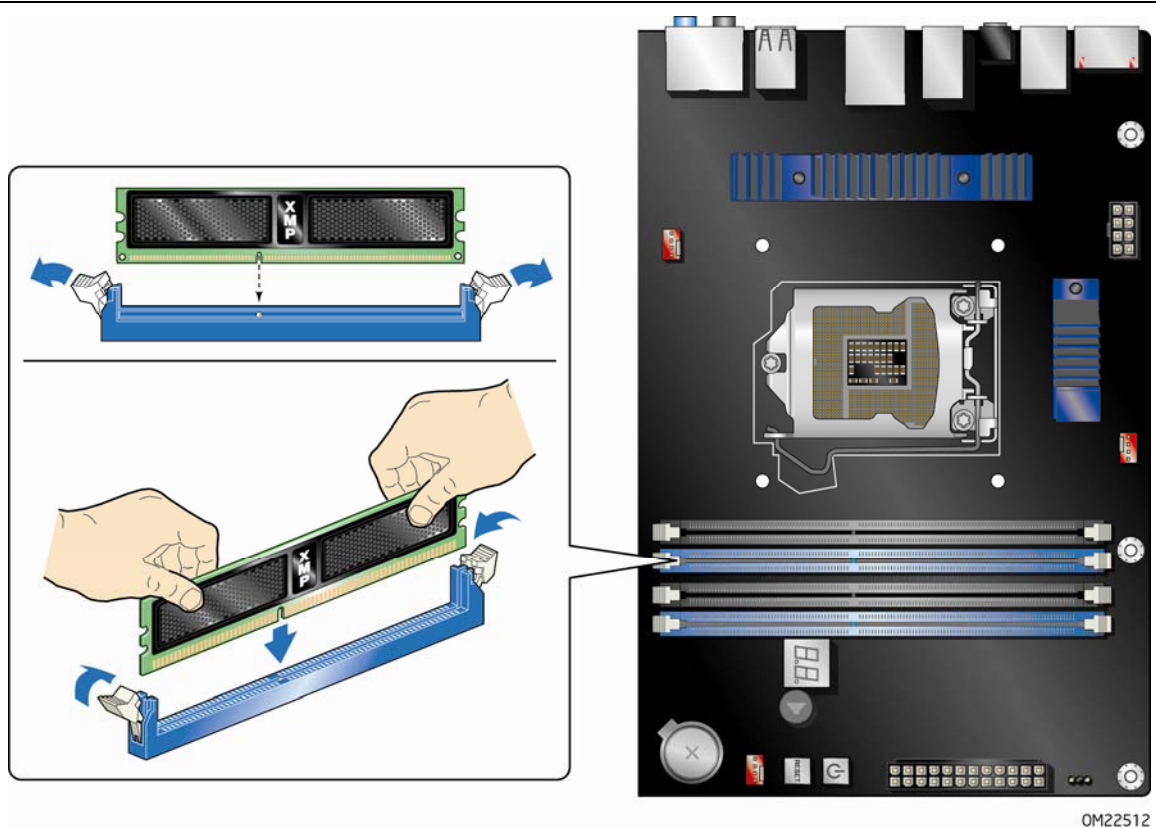

Figure 19. Installing a DIMM

4. Make sure the clips at either end of the DIMM socket(s) are pushed outward to the open position.
5. Holding the DIMM by the edges, remove it from its anti-static package.
6. Position the DIMM above the socket. Align the small notch at the bottom edge of the DIMM with the keys in the socket (see inset in Figure 19).
7. Insert the bottom edge of the DIMM into the socket.
8. When the DIMM is inserted, push down on the top edge of the DIMM until the retaining clips snap into place. Make sure the clips are firmly in place.
9. Replace the computer's cover and reconnect the AC power cord.

Removing DIMMs

To remove a DIMM, follow these steps:

1. Observe the precautions in "Before You Begin" on page 31.
2. Turn off all peripheral devices connected to the computer. Turn off the computer.
3. Remove the AC power cord from the computer.
4. Remove the computer's cover.
5. Gently spread the retaining clips at each end of the DIMM socket. The DIMM pops out of the socket.
6. Hold the DIMM by the edges, lift it away from the socket, and store it in an anti-static package.
7. Replace the computer's cover and reconnect the AC power cord.

Installing and Removing PCI Express x16 Graphics Cards

Installing a PCI Express x16 Graphics Card



CAUTION

When installing a PCI Express card, ensure that the card is fully seated in the PCI Express connector before you power on the system. If the card is not fully seated in the connector, an electrical short may result across the connector pins. Depending on the over-current protection of the power supply, certain Desktop Board components and/or traces may be damaged.

Follow these instructions to install a PCI Express x16 graphics card:

1. Observe the precautions in "Before You Begin" on page 31.
2. Place the card in the PCI Express x16 connector (Figure 20, A) and press down on the card until it is completely seated in the connector and the card retention notch on the card snaps into place around the retention mechanism pin on the connector.
3. Secure the card's metal bracket to the chassis back panel with a screw (Figure 20, B).
4. Connect the monitor cable to the graphics card according to the manufacturer's instructions.

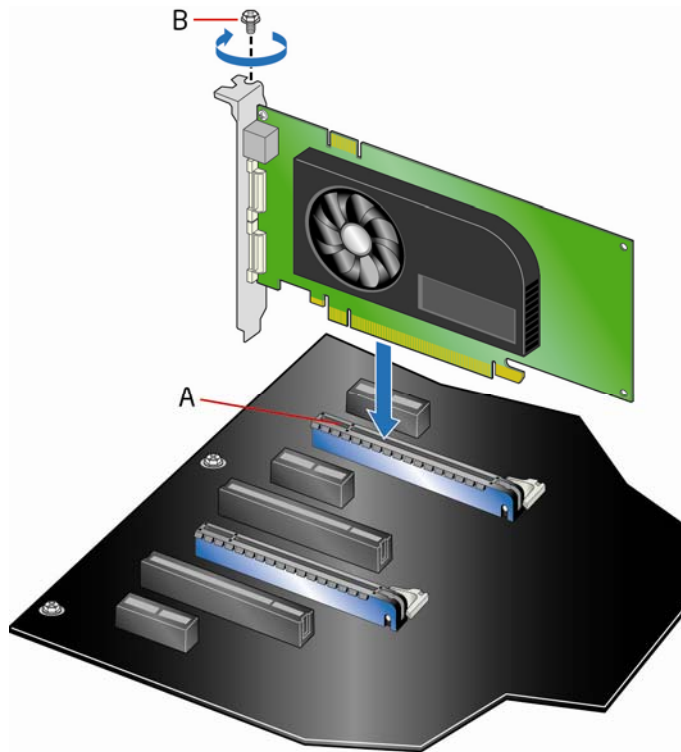

0M22514

Figure 20. Installing a PCI Express x16 Graphics Card

Removing a PCI Express x16 Graphics Card

Follow these instructions to remove a PCI Express x16 graphics card from a connector:

1. Observe the precautions in "Before You Begin" on page 31.
2. Remove the screw (Figure 21, A) that secures the card's metal bracket to the chassis back panel.
3. Push the card ejector lever down using the tip of a pencil or similar tool (Figure 21, B) in the notch. This will release the card from the connector (C).
4. Pull the card straight up to remove it.

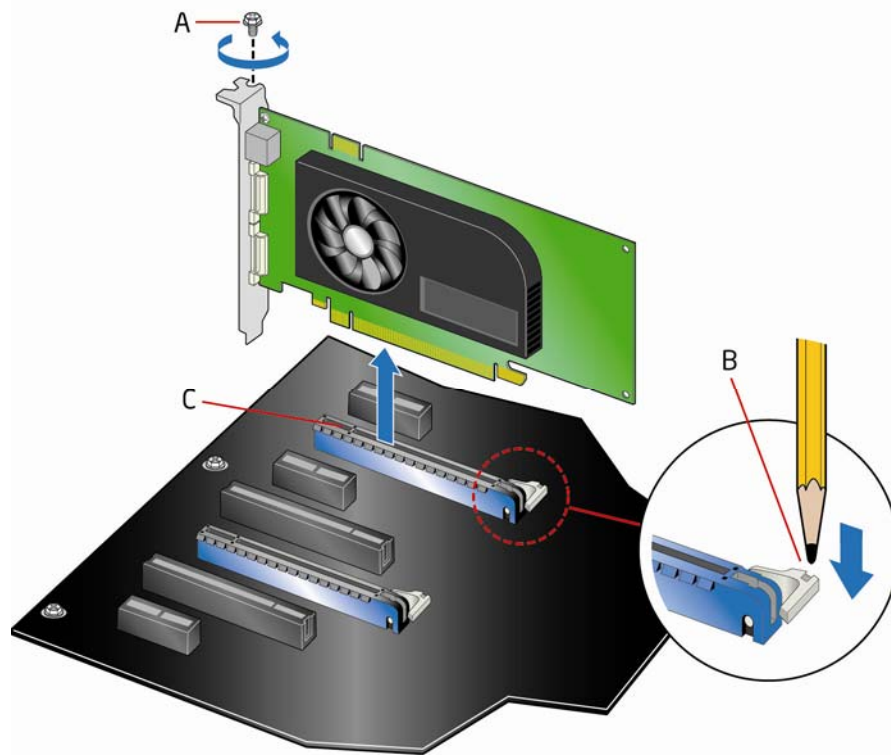

QM22516

Figure 21. Removing a PCI Express x16 Graphics Card

Installing Linked PCI Express Graphics Cards

The Desktop Board supports technology that allows you to install linked PCI Express graphics cards such as NVIDIA* SLI* (Scalable Link Interface) cards. Make sure you use two identical SLI-ready graphics cards that are NVIDIA certified and the latest graphics driver. You can use the connector included with the Desktop Board to connect the two graphics cards together. Visit the NVIDIA zone website (<http://nzone.com>) for more information.

To install two linked PCI Express graphics cards:

1. Observe the precautions in "Before You Begin" on page 31.
2. Install the first card in the PCI Express x16 connector as described in "Installing a PCI Express x16 Graphics Card" on page 44.
3. Place the second card in the secondary PCI Express x16 connector (Figure 22, A) and press down on the card until it is completely seated in the connector and the card retention notch on the card snaps into place around the retention mechanism pin on the connector.
4. Secure the card's metal bracket to the chassis back panel with a screw (Figure 22, B).
5. Connect the two cards together with the SLI bridge (Figure 22, C) as shown.
6. Connect the monitor cable to the graphics card according to the manufacturer's instructions.

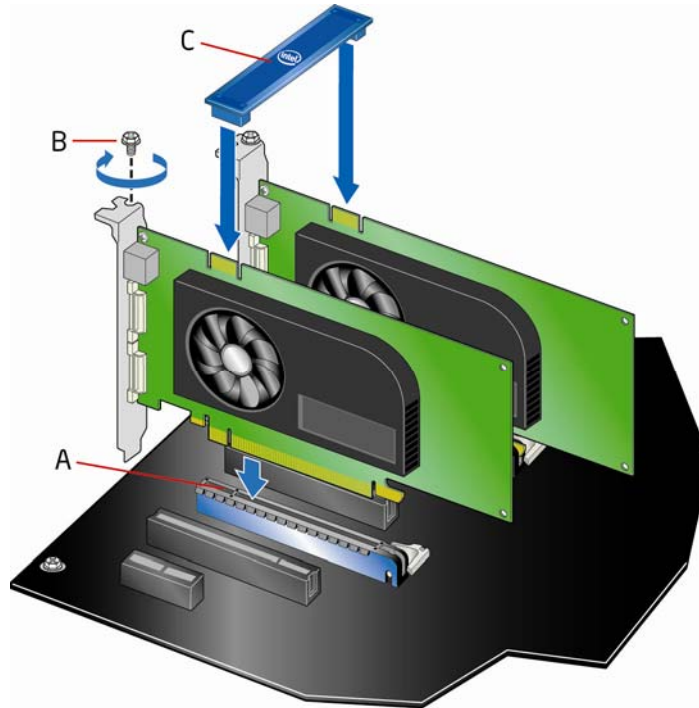

OM22515

Figure 22. Installing Linked PCI Express Graphics Cards

For more complete installation and configuration information refer to the documentation supplied by the graphics card manufacturer or visit their website.

Connecting the Serial ATA (SATA) Cables

SATA cables support the Serial ATA protocol. Each cable can be used to connect one internal SATA drive to the Desktop Board. For correct cable function:

1. Observe the precautions in "Before You Begin" on page 31.
2. Attach one end of the SATA cable to one of the SATA connectors on the board (Figure 23, A) and attach the other end of the cable to the SATA drive (Figure 23, B).

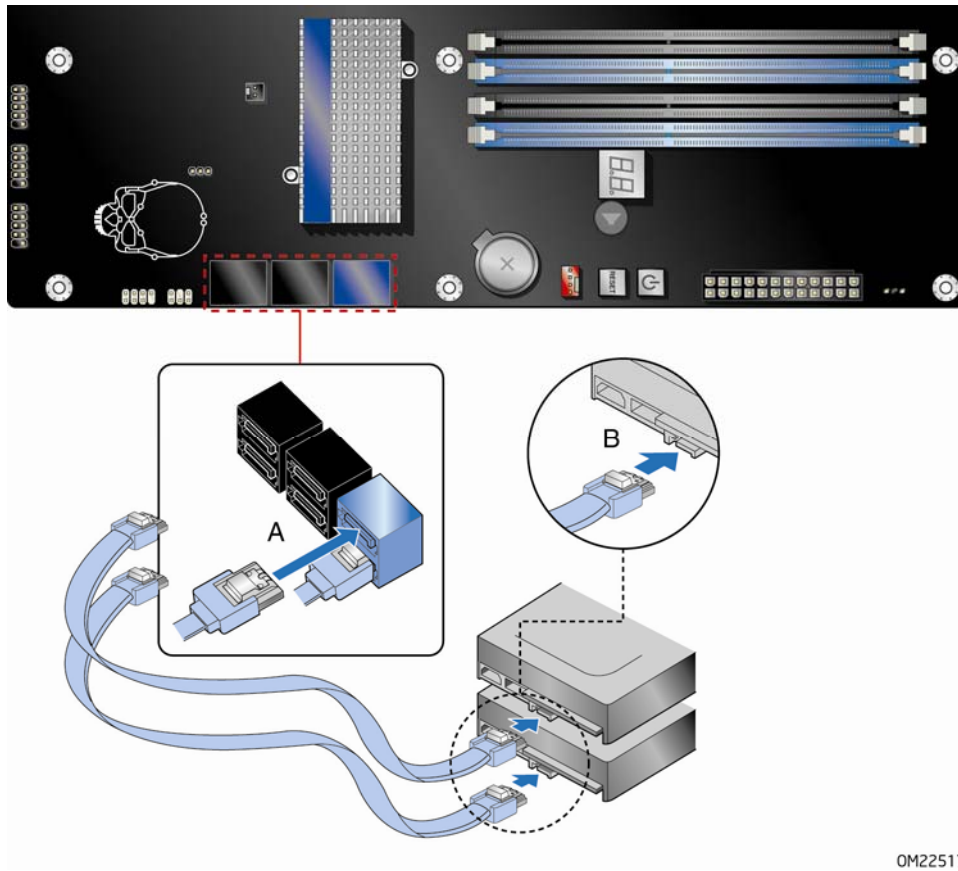

OM22517

Figure 23. Connecting the Serial ATA Cables

Connecting to the Internal Headers

Before connecting cables to any of the internal headers, observe the precautions in “Before You Begin” on page 31. Figure 24 shows the location of the internal headers and connectors on Intel Desktop Board DZ68ZV.

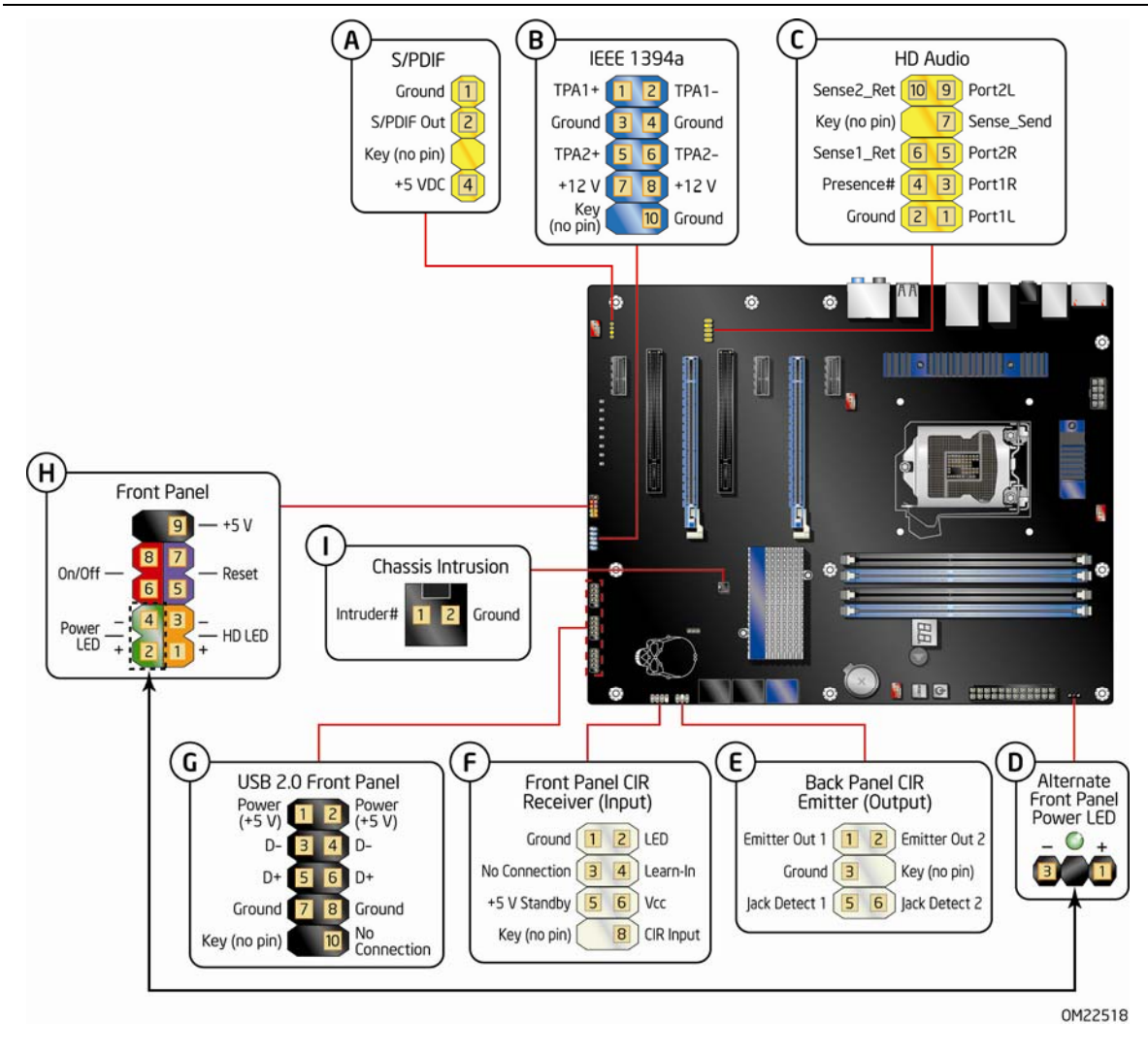

Figure 24. Internal Headers

S/PDIF Header

Figure 24, A shows the location of the S/PDIF output header. Table 6 shows the pin assignments and signal names for the S/PDIF connector.

Table 6. S/PDIF Header Signal Names

Pin	Description
1	Ground
2	S/PDIF Out
3	Key (no pin)
4	+5 VDC

IEEE 1394a Header

Figure 24, B shows the location of the IEEE 1394a header. Table 7 shows the pin assignments and signal names for the IEEE 1394a header.

Table 7. IEEE 1394a Header Signal Names

Pin	Signal Name	Pin	Signal Name
1	TPA1+	2	TPA1-
3	Ground	4	Ground
5	TPA2+	6	TPA2-
7	+12 V	8	+12 V
9	Key (no pin)	10	Ground

Front Panel Intel HD Audio Header

Figure 24, C shows the location of the front panel Intel HD Audio header. Table 8 shows the pin assignments and signal names for the front panel Intel HD Audio header.

Table 8. Front Panel Intel HD Audio Header Signal Names

Pin	Signal Name	Pin	Signal Name
1	PORT 1L	2	GND
3	PORT 1R	4	PRESENCE#
5	PORT 2R	6	SENSE1_RETURN
7	SENSE_SEND	8	KEY (no pin)
9	PORT 2L	10	SENSE2_RETURN

Alternate Front Panel Power LED Header

Figure 24, D shows the location of the alternate front panel power LED header. Pins 1 and 3 of this header duplicate the signals on pins 2 and 4 of the front panel header. If your chassis has a three-pin power LED cable, connect it to this header. Table 9 shows the pin assignments for the alternate front panel header.

Table 9. Alternate Front Panel Power LED Header Signal Names

Pin	Signal Name	In/Out
1	Front panel green LED	Out
2	No pin	
3	Front panel yellow LED	Out

Consumer IR (CIR) Headers

The Desktop Board has two CIR headers: the input or receiver header (Figure 24, F) and the output or emitter header (Figure 24, E). The receiver header consists of a filtered translated infrared input compliant with Microsoft CIR specifications and a "learning" infrared input. The learning input is a high-pass input which the computer can use to "learn" to speak the infrared communication language of other user remotes. The emitter header consists of two output ports which the computer can use to emulate "learned" infrared commands in order to control external electronic hardware.



NOTE

The Consumer IR option must be enabled in the system BIOS before it can function. Press <F2> at boot to enter the system BIOS, and go to Advanced > Peripheral Configuration > Enhanced Consumer IR, and set this option to Enabled.

Table 10 shows the pin assignments and signal names for the front panel CIR receiver (input) header and Table 11 shows the pin assignments and signal names for the back panel CIR emitter (output) header.

Table 10. Front Panel CIR Receiver (Input) Header Signal Names

Pin	Signal Name	Pin	Signal Name
1	Ground	2	LED
3	No Connection	4	Learn-In
5	+5 V Standby	6	Vcc
7	Key (no pin)	8	CIR Input

Table 11. Back Panel CIR Header Emitter (Output) Header Signal Names

Pin	Signal Name	Pin	Signal Name
1	Emitter Out 1	2	Emitter Out 2
3	Ground	4	Key (no pin)
5	Jack Detect 1	6	Jack Detect 2

USB 2.0 Headers

Figure 24, G shows the location of the USB 2.0 headers. Table 12 shows the pin assignments and signal names for each USB 2.0 header. Each USB header can be used to connect two USB devices.

Table 12. USB 2.0 Header Signal Names

USB Port A		USB Port B	
Pin	Signal Name	Pin	Signal Name
1	Power (+5 V)	2	Power (+5 V)
3	D-	4	D-
5	D+	6	D+
7	Ground	8	Ground
9	Key	10	No Connection



NOTE

Computer systems that have an unshielded cable attached to a USB port might not meet FCC Class B requirements, even if no device or a low-speed USB device is attached to the cable. Use a shielded cable that meets the requirements for a full-speed USB device.

Front Panel Header

Figure 24, H shows the location of the front panel header. Table 13 shows the pin assignments and signal names for the front panel header.

Table 13. Front Panel Header Signal Names

Pin	Description	In/Out	Pin	Description	In/Out
Hard Drive Activity LED			Power LED		
1	Hard disk LED pull-up to +5 V	Out	2	Front panel green LED	Out
3	Hard disk active LED	Out	4	Front panel yellow LED	Out
Reset Switch			On/Off Switch		
5	Ground		6	Power switch	In
7	Reset switch	In	8	Ground	
Power			Not Connected		
9	Power	Out	10	No pin	



NOTE

When connecting individual wires from your chassis front panel to the front panel header, be sure to observe the connection polarity. Positive wires are usually solid color and negative wires are usually white or striped.

Chassis Intrusion Header

Figure 24, I shows the location of the chassis intrusion header. This header can be connected to a mechanical switch on the chassis to detect if the chassis cover is removed. This switch should be in the open position when the chassis cover is installed and closed when the cover is removed.

Table 14 shows the pin assignments and signal names for the chassis intrusion header.

Table 14. Chassis Intrusion Header Signal Names

Pin	Description
1	Intruder#
2	Ground

Connecting to the Audio System

After installing the Realtek audio driver from the Intel® Express Installer DVD-ROM, the multi-channel audio feature can be enabled. Figure 25 shows the back panel audio connectors. The default connector assignments are shown in the table.

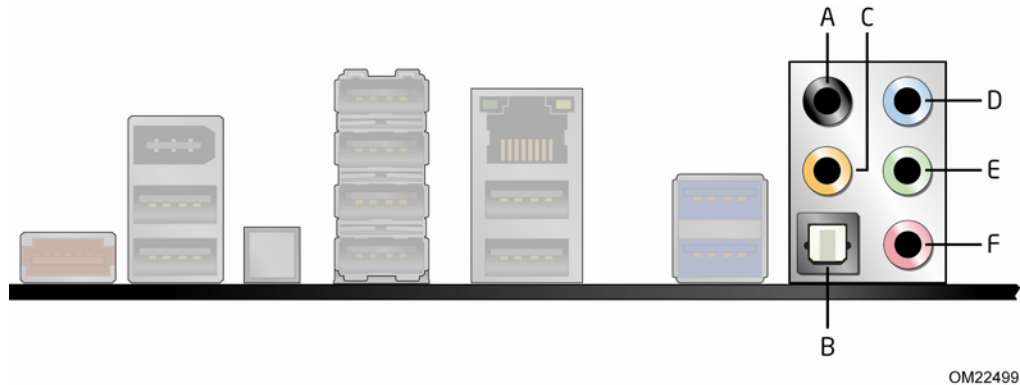

OM22499

Item	Description
A	Rear surround speakers
B	S/PDIF output (optical)
C	Center/subwoofer
D	Line in
E	Front speakers
F	Mic in

Figure 25. Back Panel Audio Connectors



NOTE

The back panel line out connector is designed to power either headphones or amplified speakers only. Poor audio quality may occur if passive (non-amplified) speakers are connected to this output.

Connecting Chassis Fan and Power Supply Cables

Connecting Chassis Fan Cables

Connect chassis fan cables to the chassis fan headers on the Desktop Board. Figure 26 shows the location of the chassis fan headers.

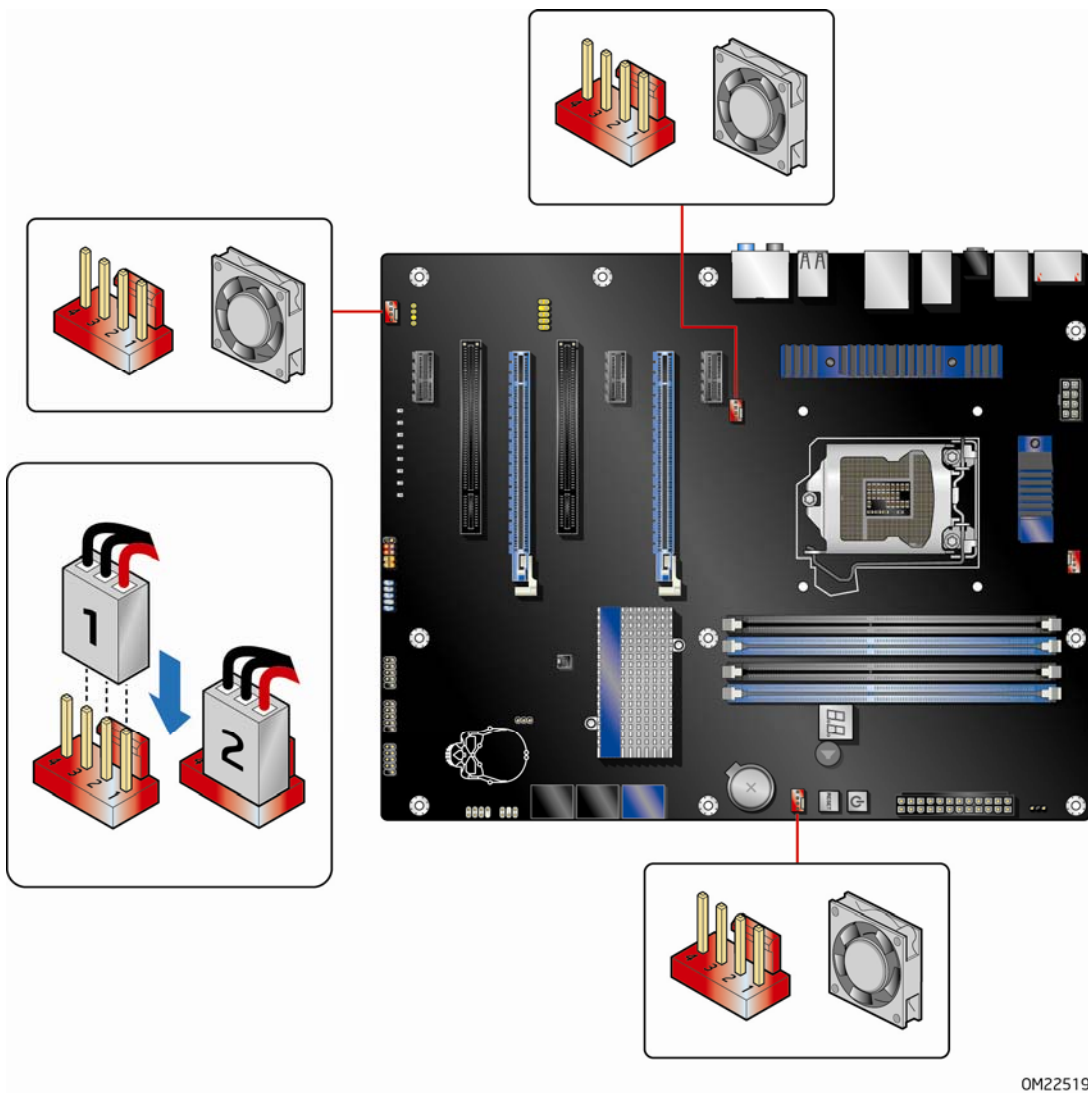

Figure 26. Location of the Chassis Fan Headers

Connecting Power Supply Cables

Figure 27 shows the location of the power connectors.



CAUTION

Failure to use an appropriate power supply and/or not connecting the 12 V (Figure 27, A) power connector to the Desktop Board may result in damage to the board or the system may not function properly.

The 2 x 12 pin main power connector (Figure 27, C) is backwards compatible with ATX12V power supplies with 2 x 10 connectors.

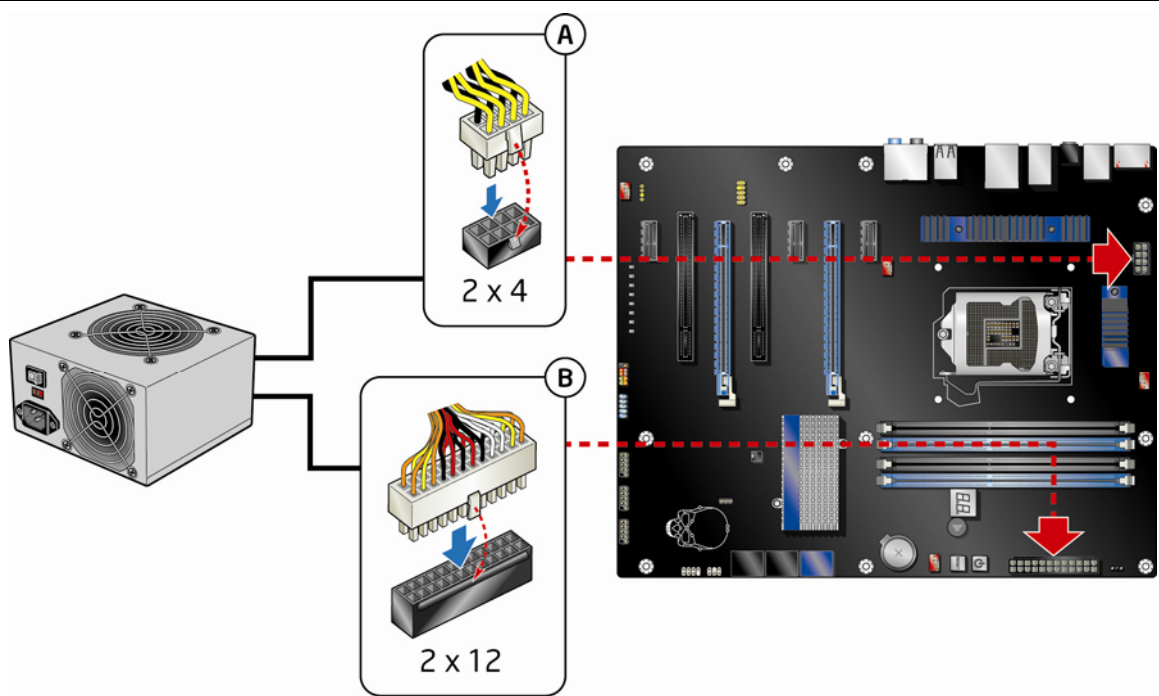

OM22520

Figure 27. Connecting Power Supply Cables

1. Observe the precautions in "Before You Begin" on page 31.
2. Connect the 12 V processor core voltage power supply cable to the 2 x 4 pin connector (Figure 27, A).
3. Connect the main power supply cable to the 2 x 12 pin connector (Figure 27, C).

Setting the BIOS Configuration Jumper



NOTE

Always turn off the power and unplug the power cord from the computer before moving the jumper. Moving the jumper with the power on may result in unreliable computer operation.

Figure 28 shows the location of the Desktop Board's BIOS configuration jumper block.

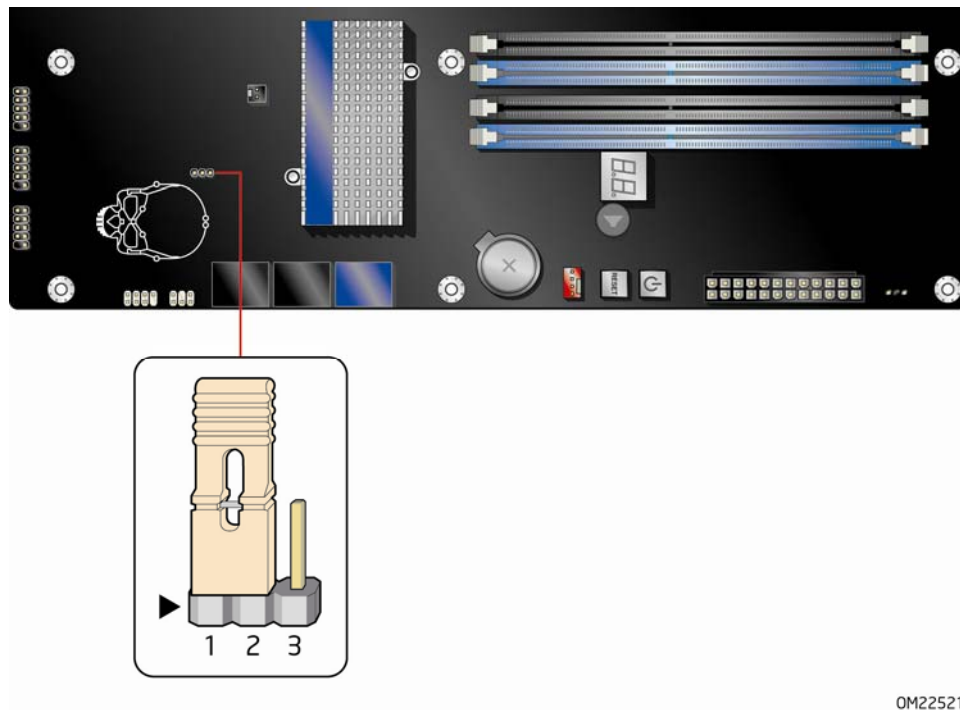

OM22521

Figure 28. Location of the BIOS Configuration Jumper Block

The three-pin BIOS jumper block enables board configuration to be done in the BIOS Setup program. Table 15 shows the jumper settings for the BIOS Setup program modes.

Table 15. Jumper Settings for the BIOS Setup Program Modes

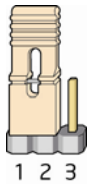
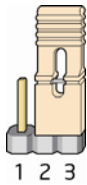
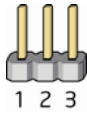
Jumper Setting	Mode	Description
	Normal (default) (1-2)	The BIOS uses the current configuration and passwords for booting.
	Configure (2-3)	After the Power-On Self-Test (POST) runs, the BIOS displays the Maintenance Menu. Use this menu to clear passwords.
	Recovery (None)	The BIOS recovers data in the event of a failed BIOS update.

Clearing Passwords

This procedure assumes that the board is installed in the computer and the configuration jumper block is set to normal mode.

1. Observe the precautions in "Before You Begin" on page 31.
2. Turn off all peripheral devices connected to the computer. Turn off the computer. Disconnect the computer's power cord from the AC power source (wall outlet or power adapter).
3. Remove the computer cover.
4. Find the configuration jumper block (see Figure 28).
5. Place the jumper on pins 2-3 as shown below.

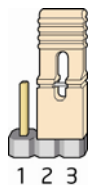

6. Replace the cover, plug in the computer, turn on the computer, and allow it to boot.
7. The computer starts the Setup program. Setup displays the Maintenance menu.
8. Use the arrow keys to select Clear Passwords. Press <Enter> and Setup displays a pop-up screen requesting that you confirm clearing the password. Select Yes and press <Enter>. Setup displays the maintenance menu again.
9. Press <F10> to save the current values and exit Setup.

10. Turn off the computer. Disconnect the computer's power cord from the AC power source.
11. Remove the computer cover.
12. To restore normal operation, place the jumper on pins 1-2 as shown below.

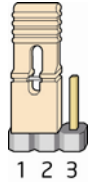

13. Replace the cover, plug in the computer, and turn on the computer.

Replacing the Battery

A coin-cell battery (CR2032) powers the real-time clock and CMOS memory. When the computer is not plugged into a wall socket, the battery has an estimated life of three years. When the computer is plugged in, the standby current from the power supply extends the life of the battery. The clock is accurate to ± 13 minutes/year at 25 °C with 3.3 VSB applied.

When the voltage drops below a certain level, the BIOS Setup program settings stored in CMOS RAM (for example, the date and time) might not be accurate. Replace the battery with an equivalent one. Figure 29 on page 64 shows the location of the battery.



CAUTION

Risk of explosion if the battery is replaced with an incorrect type. Batteries should be recycled where possible. Disposal of used batteries must be in accordance with local environmental regulations.



PRÉCAUTION

Risque d'explosion si la pile usagée est remplacée par une pile de type incorrect. Les piles usagées doivent être recyclées dans la mesure du possible. La mise au rebut des piles usagées doit respecter les réglementations locales en vigueur en matière de protection de l'environnement.



FORHOLDSREGEL

Eksplussionsfare, hvis batteriet erstattes med et batteri af en forkert type. Batterier bør om muligt genbruges. Bortskaffelse af brugte batterier bør foregå i overensstemmelse med gældende miljølovgivning.



OBS!

Det kan oppstå eksplosjonsfare hvis batteriet skiftes ut med feil type. Brukte batterier bør kastes i henhold til gjeldende miljølovgivning.



VIKTIGT!

Risk för explosion om batteriet ersätts med felaktig batterityp. Batterier ska kasseras enligt de lokala miljövårdsbestämmelserna.



VARO

Räjähdyksvaara, jos pariston tyyppi on väärä. Paristot on kierrätettävä, jos se on mahdollista. Käytetyt paristot on hävitettävä paikallisten ympäristömääräysten mukaisesti.



VORSICHT

Bei falschem Einsetzen einer neuen Batterie besteht Explosionsgefahr. Die Batterie darf nur durch denselben oder einen entsprechenden, vom Hersteller empfohlenen Batterietyp ersetzt werden. Entsorgen Sie verbrauchte Batterien den Anweisungen des Herstellers entsprechend.



AVVERTIMENTO

Esiste il pericolo di un esplosione se la pila non viene sostituita in modo corretto. Utilizzare solo pile uguali o di tipo equivalente a quelle consigliate dal produttore. Per disfarsi delle pile usate, seguire le istruzioni del produttore.



PRECAUCIÓN

Existe peligro de explosión si la pila no se cambia de forma adecuada. Utilice solamente pilas iguales o del mismo tipo que las recomendadas por el fabricante del equipo. Para deshacerse de las pilas usadas, siga igualmente las instrucciones del fabricante.



WAARSCHUWING

Er bestaat ontploffingsgevaar als de batterij wordt vervangen door een onjuist type batterij. Batterijen moeten zoveel mogelijk worden gerecycled. Houd u bij het weggoaien van gebruikte batterijen aan de plaatselijke milieuwetgeving.



ATENÇÃO

Haverá risco de explosão se a bateria for substituída por um tipo de bateria incorreto. As baterias devem ser recicladas nos locais apropriados. A eliminação de baterias usadas deve ser feita de acordo com as regulamentações ambientais da região.



AŚCIAROŹZNAŚĆ

Існуе рызыка выбуху, калі заменены акумулятар неправільнага тыпу. Акумулятары павінны, па магчымасці, перепрацоўвацца. Пазбаўляцца ад старых акумулятараў патрэбна згодна з мясцовым заканадаўствам па экалогіі.



UPOZORNĚNÍ

V případě výměny baterie za nesprávný druh může dojít k výbuchu. Je-li to možné, baterie by měly být recyklovány. Baterie je třeba zlikvidovat v souladu s místními předpisy o životním prostředí.



Προσοχή

Υπάρχει κίνδυνος για έκρηξη σε περίπτωση που η μπαταρία αντικατασταθεί από μία λανθασμένου τύπου. Οι μπαταρίες θα πρέπει να ανακυκλώνονται όταν κάτι τέτοιο είναι δυνατό. Η απόρριψη των χρησιμοποιημένων μπαταριών πρέπει να γίνεται σύμφωνα με τους κατά τόπο περιβαλλοντικούς κανονισμούς.



VIGYÁZAT

Ha a telepet nem a megfelelő típusú telepre cseréli, az felrobbanhat. A telepeket lehetőség szerint újra kell hasznosítani. A használt telepeket a helyi környezetvédelmi előírásoknak megfelelően kell kiselejtezni.



注意

異なる種類の電池を使用すると、爆発の危険があります。リサイクルが可能な地域であれば、電池をリサイクルしてください。使用後の電池を破棄する際には、地域の環境規制に従ってください。



AWAS

Risiko letupan wujud jika bateri digantikan dengan jenis yang tidak betul. Bateri sepatutnya dikitar semula jika boleh. Pelupusan bateri terpakai mestilah mematuhi peraturan alam sekitar tempatan.



OSTRZEŻENIE

Istnieje niebezpieczeństwo wybuchu w przypadku zastosowania niewłaściwego typu baterii. Zużyte baterie należy w miarę możliwości utylizować zgodnie z odpowiednimi przepisami ochrony środowiska.



PRECAUȚIE

Risc de explozie, dacă bateria este înlocuită cu un tip de baterie necorespunzător. Bateriile trebuie reciclate, dacă este posibil. Depozitarea bateriilor uzate trebuie să respecte reglementările locale privind protecția mediului.



ВНИМАНИЕ

При использовании батареи несоответствующего типа существует риск ее взрыва. Батареи должны быть утилизированы по возможности. Утилизация батарей должна проводиться по правилам, соответствующим местным требованиям.



UPOZORNENIE

Ak batériu vymeníte za nesprávny typ, hrozí nebezpečenstvo jej výbuchu. Batérie by sa mali podľa možnosti vždy recyklovať. Likvidácia použitých batérií sa musí vykonávať v súlade s miestnymi predpismi na ochranu životného prostredia.



POZOR

Zamenjava baterije z baterijo drugačnega tipa lahko povzroči eksplozijo. Če je mogoče, baterije reciklirajte. Rabljene baterije zavržite v skladu z lokalnimi okoljevarstvenimi predpisi.



คำเตือน

ระวังการระเบิดที่เกิดจากเปลี่ยนแบตเตอรี่ผิดประเภท หากเป็นไปได้ ควรนำแบตเตอรี่ไปรีไซเคิล การทิ้งแบตเตอรี่ใช้แล้วต้องเป็นไปตามกฎข้อบังคับด้านสิ่งแวดล้อมของท้องถิ่น.



UYARI

Yanlış türde pil takıldığında patlama riski vardır. Piller mümkün olduğunda geri dönüştürülmelidir. Kullanılmış piller, yerel çevre yasalarına uygun olarak atılmalıdır.



ОСТОРОГА

Використовуйте батареї правильного типу, інакше існуватиме ризик вибуху. Якщо можливо, використані батареї слід утилізувати. Утилізація використаних батарей має бути виконана згідно місцевих норм, що регулюють охорону довкілля.



UPOZORNĚNÍ

V případě výměny baterie za nesprávný druh může dojít k výbuchu. Je-li to možné, baterie by měly být recyklovány. Baterie je třeba zlikvidovat v souladu s místními předpisy o životním prostředí.



ETTEVAATUST

Kui patarei asendatakse uue ebasobivat tüüpi patareiga, võib tekkida plahvatusoht. Tühjad patareid tuleb võimaluse korral viia vastavasse kogumispunkti. Tühjade patareide äraviskamisel tuleb järgida kohalikke keskkonnakaitse alaseid reegleid.



FIGYELMEZTETÉS

Ha az elemet nem a megfelelő típusúra cseréli, felrobbanhat. Az elemeket lehetőség szerint újra kell hasznosítani. A használt elemeket a helyi környezetvédelmi előírásoknak megfelelően kell kiselejtezni.



UZMANĪBU

Pastāv eksplozijas risks, ja baterijas tiek nomainītas ar nepareiza veida baterijām. Ja iespējams, baterijas vajadzētu nodot attiecīgos pieņemšanas punktus. Bateriju izmešanai atkritumos jānotiek saskaņā ar vietējiem vides aizsardzības noteikumiem.



DĒMESIO

Naudojant netinkamo tipo baterijas iřrenginys gali sprogti. Kai tik įmanoma, baterijas reikia naudoti pakartotinai. Panaudotas baterijas išmesti būtina pagal vietinius aplinkos apsaugos nuostatus.



ATTENZJONI

Riskju ta' splużjoni jekk il-batterija tinbidel b'tip ta' batterija mhux korrett. Il-batteriji għandhom jiġu riċiklati fejn hu possibbli. Ir-rimi ta' batteriji użati għandu jsir skond ir-regolamenti ambjentali lokali.



OSTRZEŻENIE

Ryzyko wybuchu w przypadku wymiany na baterie niewłaściwego typu. W miarę możliwości baterie należy poddać recyklingowi. Zużytych baterii należy pozbywać się zgodnie z lokalnie obowiązującymi przepisami w zakresie ochrony środowiska.

To replace the battery, follow these steps:

1. Observe the precautions in "Before You Begin" (see page 31).
2. Turn off all peripheral devices connected to the computer. Disconnect the computer's power cord from the AC power source (wall outlet or power adapter).
3. Remove the computer cover.
4. Locate the battery on the board (see Figure 29).
5. With a medium flat-bladed screwdriver, gently pry the battery free from its connector. Note the orientation of the "+" and "-" on the battery.
6. Install the new battery in the connector, orienting the "+" and "-" correctly.
7. Replace the computer cover.

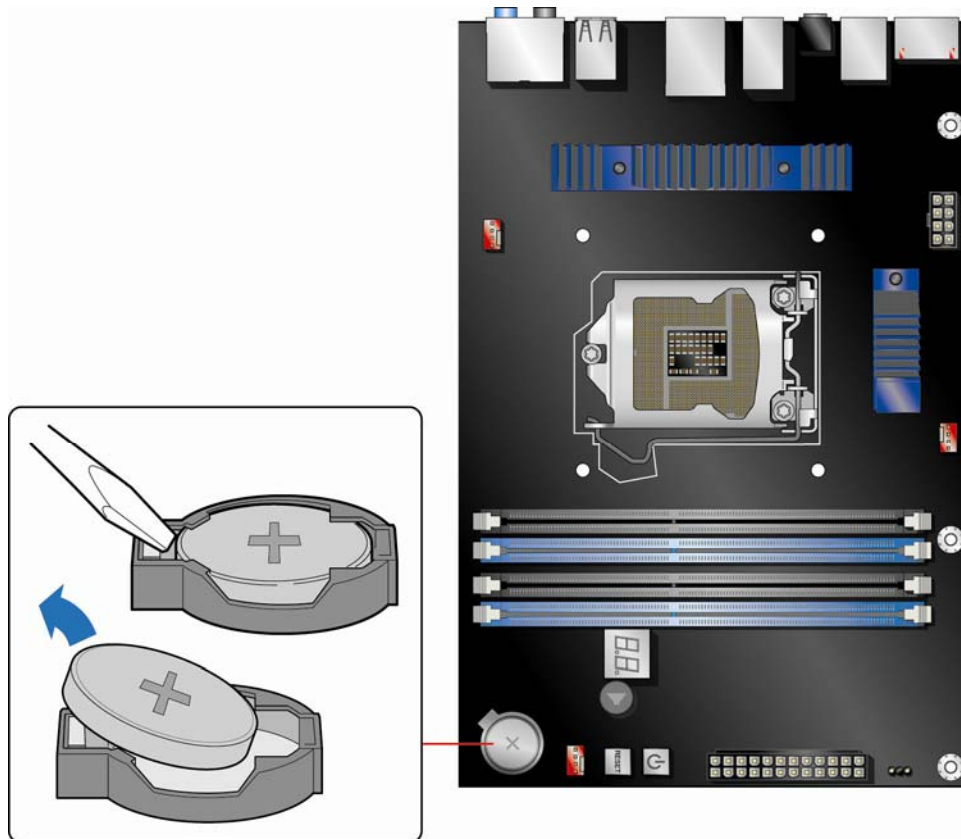

0M22513

Figure 29. Removing the Battery

Installing the WiFi/Bluetooth Module in a Desktop Chassis (optional)



NOTE

Additional WiFi/Bluetooth modules can be ordered online from http://click.intel.com/Desktop_system_parts-0-C97.aspx.

Installing the WiFi/Bluetooth module that is shipped with Intel Desktop Board DZ68ZV in your desktop system allows you to connect to wireless networks and Bluetooth peripherals.

The recommended installation procedure for a typical desktop chassis is as follows:

1. Observe the precautions in "Before You Begin" on page 31.
2. Make sure that the system is turned off and disconnected from its power source.
3. Remove the plastic cover from an empty 5-1/4 inch drive bay in the chassis bezel (Figure 30, A).
4. Remove the metal filler plate from the internal drive bay (Figure 30, B).
5. Remove the paper backing covering the adhesive on the back of the WiFi/Bluetooth Module and attach the module to the back side of the plastic drive bay cover (Figure 30, C).
6. Connect one end of the USB cable to the connector on the front of the module (Figure 30, D).
7. Reinstall the plastic drive bay cover in the chassis bezel while routing the USB cable into the chassis through the empty drive bay (Figure 30, E).
8. Connect the free end of the USB cable to an unused front panel USB header on the Desktop Board (see Figure 1, DD for locations) (Figure 30, F).

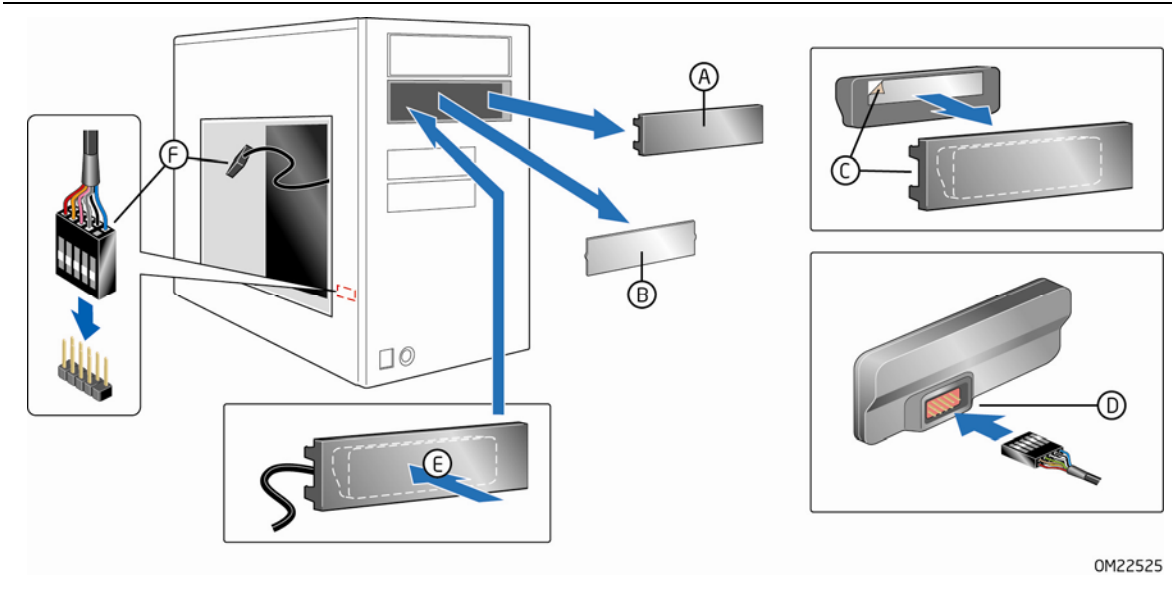

Figure 30. Installing the WiFi/Bluetooth Module

3 Updating the BIOS

The BIOS Setup program can be used to view and change the BIOS settings for the computer. You can access the BIOS Setup program by pressing the <F2> key after the Power-On Self-Test (POST) memory test begins and before the operating system boot begins.

This chapter tells you how to update the BIOS by either using the Intel Express BIOS Update utility or the Iflash Memory Update utility, and how to recover the BIOS if an update fails.

Updating the BIOS with the Intel[®] Express BIOS Update Utility

With the Intel Express BIOS Update utility you can update the system BIOS while in the Windows environment. The BIOS file is included in an automated update utility that combines the functionality of the Intel Flash Memory Update Utility and the ease of use of Windows-based installation wizards.

To update the BIOS with the Intel Express BIOS Update utility:

1. Go to the Intel World Wide Web site Download Center at <http://downloadcenter.intel.com/>
2. Navigate to the DZ68ZV page. Click on the "BIOS Update" link and then select the Express BIOS Update file.
3. Download the file to your hard drive. (You can also save this file to a removable USB device. This is useful if you are updating the BIOS for multiple identical systems.)
4. Close all other applications. This step is required. Your system will be rebooted at the last Express BIOS Update window.
5. Double-click the executable file from the location on your hard drive where it was saved. This runs the update program.
6. Follow the instructions provided in the dialog boxes to complete the BIOS update.

Updating the BIOS Using the F7 Function Key

To use this BIOS update method:

1. Download and save the Recovery BIOS (.BIO) file to a temporary directory.
2. Copy the .BIO to a USB thumb drive.
3. Plug the thumb drive into a USB port of the target computer.
4. Shut down the target computer.
5. Enable the F7 prompt display:
 - a. Power the computer on.
 - b. Enter the BIOS Setup by pressing F2 during boot.
 - c. Go to the Advanced > Boot Configuration menu.
 - d. Enable Display F7 to Update BIOS
 - e. Press F10 to save and exit.
6. During boot, when the F7 prompt is displayed, press F7 to enter the BIOS Flash Update tool.
7. Select the USB thumb drive and press Enter.
8. Select the .BIO file and press Enter
9. Confirm you want to update the BIOS by pressing Enter.
10. Wait 2-5 minutes for the update to complete.
11. Remove the thumb drive.
12. Restart the computer.

Updating the BIOS with the Intel® Flash Memory Update Utility or the ISO Image BIOS Update File

You can use the information in this section to update the BIOS using either the Intel® Flash Memory Update Utility or the ISO Image BIOS update file.

Obtaining the BIOS Update File

You can update to a new version of the BIOS by using the ISO Image BIOS update file (recommended), or Intel Flash Memory BIOS update file.

The ISO Image BIOS update file is a standardized image of a bootable CD-ROM that can be used to create a bootable CD that will update the BIOS.

The Intel Flash Memory BIOS update file is a compressed file that contains the files you need to update the BIOS. The BIOS update file contains:

- New BIOS file (including the Intel® Management Engine (Intel® ME) Firmware Image))
- Intel® Integrator Toolkit Configuration File (optional)
- Intel Flash Memory Update Utility

You can obtain either of these files through your computer supplier or by navigating to the Intel Desktop Board DZ68ZV page on the Intel World Wide Web site Download Center at <http://downloadcenter.intel.com>.

On the DZ68ZV page, click on the "BIOS Update" link and then select the the Iflash BIOS Update file.

Updating the BIOS with the Intel Flash Memory Update Utility

With the Intel Flash Memory Update Utility you can update the system BIOS from a bootable CD-ROM, bootable USB flash drive, or other bootable USB media. The utility available on the Intel World Wide Web site provides a simple method for creating a bootable CD-ROM that will automatically update your BIOS. The BIOS update files can also be extracted locally to your hard drive and copied to a bootable USB flash drive or other bootable USB media.

The Intel Flash Memory Update Utility allows you to:

- Update the BIOS and Intel Management Engine in flash memory
- Update the language section of the BIOS



NOTE

Review the instructions distributed with the update utility before attempting a BIOS update.



CAUTION

Do not interrupt the process or the system may not function properly.

1. Uncompress the BIOS update file and copy the .BIO file, IFLASH.EXE, and .ITK file (optional) to a bootable USB flash drive or other bootable USB media.
2. Configure the BIOS or use the F10 option during POST to boot to the USB device.
3. Manually run the IFLASH.EXE file from the USB device and manually update the BIOS.

Updating the BIOS with the ISO Image BIOS Update File

The ISO Image BIOS update allows for the update of an Intel® Desktop Board BIOS to the latest production release regardless of the operating system installed on the computer's hard drive and without the need to remove the BIOS configuration jumper. It requires a blank CD-R, a read/writeable CD drive, and software capable of uncompressing and writing the ISO image file to CD.

The image uses ISOLINUX* bootloader and automatically launches a script to upgrade the BIOS via the Intel Flash Memory Utility.



CAUTION

Do not interrupt the process or the system may not function properly.

Follow these instructions to upgrade the BIOS using the ISO Image BIOS file:

1. Download the ISO Image BIOS file.
2. Using software capable of uncompressing and writing an ISO image file to CD, burn the data to a blank CD.



NOTE

Copying the ISO Image BIOS file to CD will not work. The completed CD should contain multiple files and a directory.

3. Insert the CD that was created in the CD-ROM drive of the computer to be upgraded and boot the system.
4. When the "Press ENTER to continue booting from CD-ROM" prompt appears, press the Enter key. The system will boot from the hard drive if no key is pressed within 15 seconds.
5. At the "Welcome to the Intel Desktop Board BIOS Upgrade CD-ROM" page, press any key to confirm the BIOS upgrade operation.
6. Wait for the BIOS upgrade process to complete.



CAUTION

DO NOT POWER DOWN YOUR COMPUTER before the update is complete. The update may take up to 5 minutes.

Recovering the BIOS

It is unlikely that anything will interrupt the BIOS update; however, if an interruption occurs, the BIOS could be damaged. Due to BIOS size and recovery requirements, a CD-R with the .BIO file in the root directory will be required.

You can obtain the Recovery BIOS Update file through your computer supplier or by navigating to the Intel Desktop Board DZ68ZV page on the Intel World Wide Web site Download Center at <http://downloadcenter.intel.com>.

On the DZ68ZV page, click on the "BIOS Update" link and then select the Recovery BIOS Update file.



NOTE

For more information about updating the Intel Desktop Board BIOS or recovering from a BIOS update failure, go to

<http://support.intel.com/support/motherboards/desktop/sb/CS-022312.htm>.

4 Configuring Intel® Smart Response Technology and RAID Using Intel® RST

Configuring Intel Smart Response Technology



NOTE

Proper operation of Intel Smart Response Technology requires a Microsoft Windows 7 or Microsoft Windows Vista operating system and SATA HDDs and SSDs.

Follow the steps below to setup your system to use Intel Smart Response Technology:

1. Assemble your system and attach a SATA HDD and a SATA SSD (minimum capacity of 18.6 GB) to the black SATA connectors.
2. Enter system BIOS Setup by pressing <F2> after the Power-On-Self-Test (POST) memory tests begin.
3. Go to **Configuration** → **SATA Drives**.
4. Select **Chipset SATA Mode** and change the value to **RAID**.
5. Press <F10> to save the settings and restart the system.
6. Install your operating system and all required device drivers on the HDD.
7. Install the latest version of the Intel RST software.
8. Run the RST software and enable Intel Smart Response Technology.

For more installation information, refer to the *Intel Smart Response Technology User Guide* at [http://www.intel.com/support/motherboards/desktop/dz68db/sb/CS-032499.htm?wapkw=\(smart+response\)](http://www.intel.com/support/motherboards/desktop/dz68db/sb/CS-032499.htm?wapkw=(smart+response))

Configuring RAID



NOTE

Intel RST RAID requires a Microsoft Windows 7, Microsoft Windows Vista, or Microsoft Windows XP operating system and SATA hard drives.

This section describes how to:

- Configure the BIOS for RAID
- Create a RAID Set
- Load the Intel RST RAID Drivers and Software (required for Microsoft Windows XP installation only)
- Create a "RAID Ready System"

Configuring the BIOS

1. Assemble your system and attach two or more SATA hard drives to the black SATA connectors.
2. Enter system BIOS Setup by pressing <F2> after the Power-On-Self-Test (POST) memory tests begin.
3. Go to **Configuration** → **SATA Drives**.
4. Select **Chipset SATA Mode** and change the value to **RAID**.
5. Then save your settings by pressing <F10>.

Creating Your RAID Set

1. Upon re-boot, you will see the following Intel Rapid Storage Manager option ROM status message on the screen: Press <Ctrl-I> to enter the RAID Configuration Utility. Press <Ctrl-I> and enter the RAID Configuration Utility.
2. In the Intel Rapid Storage Manager option ROM Main Menu, select option #1: Create RAID Volume. Enter a volume name (using English alphanumeric ASCII characters) and press <Enter>.
3. Use the arrow keys to select RAID 0 or RAID 1 (if only two SATA drives are available), RAID 5 and RAID 10 (these options will only appear if three or four SATA drives are installed respectively). Press <Enter> once you have selected the RAID LEVEL.
4. Select the drives to be used in the RAID array (only if there are more than two drives available) and press <Enter>.
5. Select the strip size, if necessary, and press <Enter>.
6. Enter the size of the volume (if you enter less than the maximum volume size, you can then create a second RAID array on the remaining portion of your volume) and press <Enter>.
7. Finally, press <Enter> to **Create Volume**.
8. Exit the Option ROM user interface by pressing <Esc> or going to the EXIT option in the MAIN MENU.

Loading the Intel RST RAID Drivers and Software (Required for Microsoft Windows XP Installation)

1. Begin Windows Setup by booting from the Windows installation CD.
2. At the beginning of Windows Setup, press <F6> to install a third-party SCSI or RAID driver. When prompted, insert the diskette that contains the Intel RST RAID Driver in a USB floppy disk drive. Refer to <http://support.microsoft.com/kb/916196/en-us> for information on supported USB floppy disk drives. Install the Intel® SATA RAID Controller driver.
3. Finish the Windows installation and install all necessary drivers.
4. Install the Intel Rapid Storage Console software via the Intel Express Installer CD included with your Desktop Board or after downloading it from the Internet at <http://support.intel.com/support/motherboards/desktop/>. The Intel Rapid Storage Console software can be used to manage the RAID configuration.

Setting Up a "RAID Ready" System

The Intel RST Console software offers the flexibility to upgrade from a single SATA drive to RAID without reinstalling the operating system when a second SATA hard drive is added to the system.

Follow the steps described above in: "Configuring the BIOS" and "Loading the Intel RST RAID Drivers and Software."

Once additional SATA drives have been added to the system, open the Intel RST Console Software and follow the directions to update to a RAID setup.

A Error Messages and Indicators

Intel Desktop Board DZ68ZV reports POST errors in three ways:

- By sounding a beep code and blinking the front panel power LED
- By displaying an error message on the monitor
- By displaying diagnostic progress codes (POST codes)

BIOS Error Codes

Whenever a recoverable error occurs during POST, the BIOS causes the board's speaker to beep and the front panel power LED to blink an error message indicating the problem (see Table 16).

Table 16. BIOS Beep Codes

Type	Pattern
Processor initialization complete	One 0.5 second beep when the CPU initialization process completes.
POST complete	One 0.5 second beep when POST completes.
Video error	On-off (0.5 seconds each) two times, then 3.0 second pause (off), entire pattern repeats (beeps and pause) until the system is powered off.
Memory error	On-off (0.5 seconds each) three times, then 3.0 second pause (off), entire pattern repeats (beeps and pause) until the system is powered off.
Thermal trip warning	On-off (0.5 seconds each) four times, then 3.0 second pause (off), entire pattern repeats (beeps and pause) until the sixteenth beep, then ends.

Table 17. Front-panel Power LED Blink Codes

Type	Pattern
Processor initialization complete	On when the system powers up, then off for 0.5 seconds.
POST complete	On when the system powers up, then off for 0.5 seconds.
BIOS update in progress	Off when the update begins, then on for 0.5 seconds, then off for 0.5 seconds. The pattern repeats until the BIOS update is complete.
Video error	On-off (0.5 seconds each) two times, then 3.0 second pause (off), entire pattern repeats (blink and pause) until the system is powered off.
Memory error	On-off (0.5 seconds each) three times, then 3.0 second pause (off), entire pattern repeats (blinks and pause) until the system is powered off.
Thermal trip warning	On-off (0.5 seconds each) four times, then 3.0 second pause (off), entire pattern repeats (blinks and pause) until the sixteenth blink, then ends.

BIOS Error Messages

When a recoverable error occurs during the POST, the BIOS displays an error message describing the problem. Table 18 gives an explanation of the BIOS error messages.

Table 18. BIOS Error Messages

Error Message	Explanation
PROCESSOR_THERMAL_TRIP_ERROR	Processor was previously shutdown due to a thermal event (overheating).
CMOS_BATTERY_ERROR	The firmware has detected that a CMOS battery failure occurred.
CMOS_CHECKSUM_ERROR	The firmware has detected that a CMOS Checksum Error occurred.
CMOS_TIMER_ERROR	The firmware has detected that the system date/time has not been set.
MEMORY_SIZE_DECREASE_ERROR	The firmware has detected that the system memory has decreased.
INTRUDER_DETECTION_ERROR	The system chassis was opened.
SPD_TOLER_ERROR	SERIAL PRESENCE DETECT (SPD) device data missing or inconclusive. Properly programmed SPD device data is required for reliable operation.
MEM_OPTIMAL_ERROR	The installed amount of memory in Channel A is not equal to the amount of memory in Channel B. Maximum memory performance is achieved with equal amounts of memory installed in each channel.

Port 80h POST Codes

During the POST, the BIOS generates diagnostic progress codes (POST codes) to I/O port 80h. If the POST fails, execution stops and the last POST code generated is left at port 80h and displayed on the Desktop Board's seven-segment LED display shown in Figure 31. This code is useful for determining the point where an error occurred during the POST.

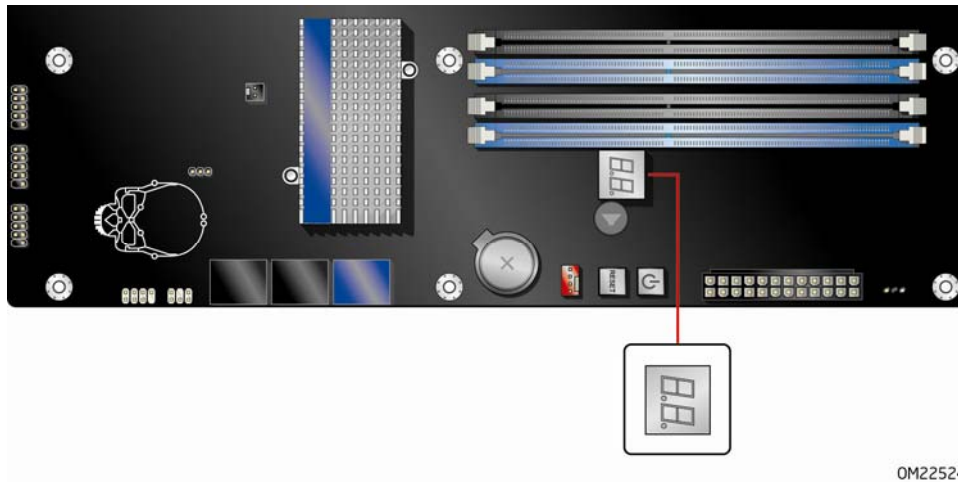

0M22524

Figure 31. POST Code LED Display

Table 19 lists the Port 80h POST codes in hexadecimal notation.

Table 19. Port 80h POST Codes

POST Code	Description
ACPI S States	
00	Entering S0 state, standard
01-05	Entering S1-S5 state
10, 20, 30, 40, 50	Resuming from S1-S5 state
Security Phase (SEC)	
08	Starting BIOS execution after CPU BIST
09	SPI prefetching and caching
0A, 0B	Load BSP/APS microcode
0C	Platform program base addresses
0D	Wake up all APS
0E	Initialize NEM
0F	Pass entry point of the PEI core

POST Code	Description
PEI Phase Before MRC	
11	Set bootmode, GPIO init
12	Early chipset register programming
13	Basic PCH init, discrete device init
14	LAN init
15	Exit early platform init driver
16	SMBUS driver init
17, 18	Entry/Exit to SMBUS execute read/write
19, 1A	Entry/Exit to CK505 programming
1B, 1C	Entry/Exit to PEI overclock programming
MEC Memory Detection	
21	MRC entry point
23	Reading SPD from memory DIMMs
24	Detecting presence of memory DIMMs
27	Configuring memory
28	Testing memory
29	Exit MRC driver
PEI After MRC	
2A, 2B	Start/finish programming MTRR settings
PEIMs/Recovery	
31, 33, 34	Recovery has initiate, load, valid
CPU Initialization (PEI, DXE, SMM)	
41-43	Begin to end CPU PEI init
44-46	Begin to end CPU SMM init/relocate bases
47-4C	CPU DXE phase begin to end
4D-4F	CPU DXE SMM phase begin to end
I/O Buses	
50-52	PCI enumeration, allocation, hot plug
58, 59	Resetting USB bus
5A, 5B	Resetting SATA bus and all devices
5F	Unrecoverable error, start with PIC
Boot Device Selection (BDS)	
60-6F	BDS driver entry
E4	Entered DXE phase
E7	Waiting for user input
E8	Checking password
E9	Entering BIOS setup
EB	Calling legacy option ROMs

POST Code	Description
Keyboard/Mouse (PS/2 or USB)	
90-95	Keyboard initialization
98-9B	Mouse initialization
Fixed Media	
B0-BF	Detecting and initializing fixed media
Runtime Phase/EFI Operating System Boot	
F8	EFI boot service ExitBootServices
F9	EFI runtime service SetVirtualAddressMap

B Regulatory Compliance

This appendix contains the following regulatory compliance information for Intel Desktop Board DZ68ZV:

- Safety standards
- European Union Declaration of Conformity statement
- Product Ecology statements
- Electromagnetic Compatibility (EMC) regulations
- Product certifications

Safety Standards

Intel Desktop Board DZ68ZV complies with the safety standards stated in Table 20 when correctly installed in a compatible host system.

Table 20. Safety Standards

Regulation	Title
CSA/UL 60950-1	Information Technology Equipment – Safety - Part 1: General Requirements (USA and Canada)
EN 60950-1	Information Technology Equipment – Safety - Part 1: General Requirements (European Union)
IEC 60950-1	Information Technology Equipment – Safety - Part 1: General Requirements (International)

Battery Caution

There is insufficient space on this Desktop Board to provide instructions for replacing and disposing of the Lithium ion coin cell battery. For system safety certification, the statement below or an equivalent statement is required to be permanently and legibly marked on the chassis near the battery.

A suitable caution label is included with Intel Desktop Board DZ68ZV.



CAUTION

Risk of explosion if the battery is replaced with an incorrect type. Batteries should be recycled where possible. Disposal of used batteries must be in accordance with local environmental regulations.

For information about replacing the battery, go to page 59.

European Union Declaration of Conformity Statement

We, Intel Corporation, declare under our sole responsibility that the product Intel® Desktop Board DZ68ZV is in conformity with all applicable essential requirements necessary for CE marking, following the provisions of the European Council Directives 2004/108/EC (EMC Directive), 2006/95/EC (Low Voltage Directive), and 2002/95/EC (ROHS Directive).

The product is properly CE marked demonstrating this conformity and is for distribution within all member states of the EU with no restrictions.



This product follows the provisions of the European Directives 2004/108/EC, 2006/95/EC and 2002/95/EC.

Čeština Tento výrobek odpovídá požadavkům evropských směrnic 2004/108/EC, 2006/95/EC a 2002/95/EC.

Dansk Dette produkt er i overensstemmelse med det europæiske direktiv 2004/108/EC, 2006/95/EC & 2002/95/EC.

Dutch Dit product is in navolging van de bepalingen van Europees Directief 2004/108/EC, 2006/95/EC & 2002/95/EC.

Eesti Antud toode vastab Euroopa direktiivides 2004/108/EC, ja 2006/95/EC ja 2002/95/EC kehtestatud nõuetele.

Suomi Tämä tuote noudattaa EU-direktiivin 2004/108/EC, 2006/95/EC & 2002/95/EC määräyksiä.

Français Ce produit est conforme aux exigences de la Directive Européenne 2004/108/EC, 2006/95/EC & 2002/95/EC.

Deutsch Dieses Produkt entspricht den Bestimmungen der Europäischen Richtlinie 2004/108/EC, 2006/95/EC & 2002/95/EC.

Ελληνικά Το παρόν προϊόν ακολουθεί τις διατάξεις των Ευρωπαϊκών Οδηγιών 2004/108/EC, 2006/95/EC και 2002/95/EC.

Magyar E termék megfelel a 2004/108/EC, 2006/95/EC és 2002/95/EC Európai Irányelv előírásainak.

Icelandic Þessi vara stenst reglugerð Evrópska Efnahags Bandalagsins númer 2004/108/EC, 2006/95/EC, & 2002/95/EC.

Italiano Questo prodotto è conforme alla Direttiva Europea 2004/108/EC, 2006/95/EC & 2002/95/EC.

Latviešu Šis produkts atbilst Eiropas Direktīvu 2004/108/EC, 2006/95/EC un 2002/95/EC noteikumiem.

Lietuvių Šis produktas atitinka Europos direktyvų 2004/108/EC, 2006/95/EC, ir 2002/95/EC nuostatas.

Malti Dan il-prodott hu konformi mal-provvedimenti tad-Direttivi Ewropej 2004/108/EC, 2006/95/EC u 2002/95/EC.

Norsk Dette produktet er i henhold til bestemmelsene i det europeiske direktivet 2004/108/EC, 2006/95/EC & 2002/95/EC.

Polski Niniejszy produkt jest zgodny z postanowieniami Dyrektyw Unii Europejskiej 2004/108/EC, 2006/95/EC i 2002/95/EC.

Portuguese Este produto cumpre com as normas da Diretiva Europeia 2004/108/EC, 2006/95/EC & 2002/95/EC.

Español Este producto cumple con las normas del Directivo Europeo 2004/108/EC, 2006/95/EC & 2002/95/EC.

Slovensky Tento produkt je v súlade s ustanoveniami európskych direktív 2004/108/EC, 2006/95/EC a 2002/95/EC.

Slovenščina Izdelek je skladen z določbami evropskih direktiv 2004/108/EC, 2006/95/EC in 2002/95/EC.

Svenska Denna produkt har tillverkats i enlighet med EG-direktiv 2004/108/EC, 2006/95/EC & 2002/95/EC.

Türkçe Bu ürün, Avrupa Birliği'nin 2004/108/EC, 2006/95/EC ve 2002/95/EC yönergelerine uyar.

Product Ecology Statements

The following information is provided to address worldwide product ecology concerns and regulations.

Recycling Considerations

As part of its commitment to environmental responsibility, Intel has implemented the Intel® Product Recycling Program to allow retail consumers of Intel's branded products to return used products to selected locations for proper recycling.

Please consult http://intel.com/intel/other/ehs/product_ecology for the details of this program, including the scope of covered products, available locations, shipping instructions, terms and conditions, etc.

中文

作为其对环境责任之承诺的部分，英特尔已实施 Intel Product Recycling Program（英特尔产品回收计划），以允许英特尔品牌产品的零售消费者将使用过的产品退还至指定地点作恰当的重复使用处理。

请参考http://intel.com/intel/other/ehs/product_ecology了解此计划的详情，包括涉及产品之范围、回收地点、运送指导、条款和条件等。

Deutsch

Als Teil von Intels Engagement für den Umweltschutz hat das Unternehmen das Intel Produkt-Recyclingprogramm implementiert, das Einzelhandelskunden von Intel Markenprodukten ermöglicht, gebrauchte Produkte an ausgewählte Standorte für ordnungsgemäßes Recycling zurückzugeben.

Details zu diesem Programm, einschließlich der darin eingeschlossenen Produkte, verfügbaren Standorte, Versandanweisungen, Bedingungen usw., finden Sie auf der http://intel.com/intel/other/ehs/product_ecology

Español

Como parte de su compromiso de responsabilidad medioambiental, Intel ha implantado el programa de reciclaje de productos Intel, que permite que los consumidores al detalle de los productos Intel devuelvan los productos usados en los lugares seleccionados para su correspondiente reciclado.

Consulte la http://intel.com/intel/other/ehs/product_ecology para ver los detalles del programa, que incluye los productos que abarca, los lugares disponibles, instrucciones de envío, términos y condiciones, etc.

Français

Dans le cadre de son engagement pour la protection de l'environnement, Intel a mis en œuvre le programme Intel Product Recycling Program (Programme de recyclage des produits Intel) pour permettre aux consommateurs de produits Intel de recycler les produits usés en les retournant à des adresses spécifiées.

Visitez la page Web http://intel.com/intel/other/ehs/product_ecology pour en savoir plus sur ce programme, à savoir les produits concernés, les adresses disponibles, les instructions d'expédition, les conditions générales, etc.

日本語

インテルでは、環境保護活動の一環として、使い終わったインテル ブランド製品を指定の場所へ返送していただき、リサイクルを適切に行えるよう、インテル製品リサイクル プログラムを発足させました。

対象製品、返送先、返送方法、ご利用規約など、このプログラムの詳細情報は、http://intel.com/intel/other/ehs/product_ecology (英語)をご覧ください。

Malay

Sebagai sebahagian daripada komitmennya terhadap tanggungjawab persekitaran, Intel telah melaksanakan Program Kitar Semula Produk untuk membenarkan pengguna-pengguna runcit produk jenama Intel memulangkan produk terguna ke lokasi-lokasi terpilih untuk dikitar semula dengan betul.

Sila rujuk http://intel.com/intel/other/ehs/product_ecology untuk mendapatkan butir-butir program ini, termasuklah skop produk yang dirangkumi, lokasi-lokasi tersedia, arahan penghantaran, terma & syarat, dsb.

Portuguese

Como parte deste compromisso com o respeito ao ambiente, a Intel implementou o Programa de Reciclagem de Produtos para que os consumidores finais possam enviar produtos Intel usados para locais selecionados, onde esses produtos são reciclados de maneira adequada.

Consulte o site http://intel.com/intel/other/ehs/product_ecology (em Inglês) para obter os detalhes sobre este programa, inclusive o escopo dos produtos cobertos, os locais disponíveis, as instruções de envio, os termos e condições, etc.

Russian

В качестве части своих обязательств к окружающей среде, в Intel создана программа утилизации продукции Intel (Product Recycling Program) для предоставления конечным пользователям марок продукции Intel возможности возврата используемой продукции в специализированные пункты для должной утилизации.

Пожалуйста, обратитесь на веб-сайт http://intel.com/intel/other/ehs/product_ecology за информацией об этой программе, принимаемых продуктах, местах приема, инструкциях об отправке, положениях и условиях и т.д.

Türkçe

Intel, çevre sorumluluğuna bağlılığının bir parçası olarak, perakende tüketicilerin Intel markalı kullanılmış ürünlerini belirlenmiş merkezlere iade edip uygun şekilde geri dönüştürmesini amaçlayan Intel Ürünleri Geri Dönüşüm Programı'nı uygulamaya koymuştur.

Bu programın ürün kapsamı, ürün iade merkezleri, nakliye talimatları, kayıtlar ve şartlar v.s dahil bütün ayrıntılarını öğrenmek için lütfen http://intel.com/intel/other/ehs/product_ecology web sayfasına gidin.

China RoHS

Intel Desktop Board DZ68ZV is a China RoHS-compliant product.

The China Ministry of Information Industry (MII) stipulates that a material Self Declaration Table (SDT) must be included in a product's user documentation. The SDT for Intel Desktop Board DZ68ZV is shown in Figure 32.

关于符合中国《电子信息产品污染控制管理办法》的声明

**Management Methods on Control of Pollution from
Electronic Information Products
(China RoHS declaration)**

产品中有毒有害物质的名称及含量

部件名称 (Parts)	有毒有害物质或元素					
	铅 (Pb)	汞 (Hg)	镉 (Cd)	六价铬 (Cr6+)	多溴联苯 (PBB)	多溴二苯醚 (PBDE)
主板组件 Motherboard Assembly	×	○	○	○	○	○
<p>○：表示该有毒有害物质在该部件所有均质材料中的含量均在 SJ/T 11363-2006 标准规定的限量要求以下。</p> <p>○：Indicates that this hazardous substance contained in all homogeneous materials of this part is below the limit requirement in SJ/T 11363-2006.</p> <p>×：表示该有毒有害物质至少在该部件的某一均质材料中的含量超出 SJ/T 11363-2006 标准规定的限量要求。</p> <p>×：Indicates that this hazardous substance contained in at least one of the homogeneous materials of this part is above the limit requirement in SJ/T 11363-2006.</p> <p>对销售之日的所售产品,本表显示我公司供应链的电子信息产品可能包含这些物质。注意：在所售产品中可能会也可能不会含有所有所列的部件。</p> <p>This table shows where these substances may be found in the supply chain of our electronic information products, as of the date of sale of the enclosed product. Note that some of the component types listed above may or may not be a part of the enclosed product.</p>						

Figure 32. Intel Desktop Board DZ68ZV China RoHS Material Self Declaration Table

EMC Regulations

Intel Desktop Board DZ68ZV complies with the EMC regulations stated in Table 21 when correctly installed in a compatible host system.

Table 21. EMC Regulations

Regulation	Title
FCC 47 CFR Part 15, Subpart B	Title 47 of the Code of Federal Regulations, Part 15, Subpart B, Radio Frequency Devices. (USA)
ICES-003	Interference-Causing Equipment Standard, Digital Apparatus. (Canada)
EN55022	Limits and methods of measurement of Radio Interference Characteristics of Information Technology Equipment. (European Union)
EN55024	Information Technology Equipment – Immunity Characteristics Limits and methods of measurement. (European Union)
EN55022	Australian Communications Authority, Standard for Electromagnetic Compatibility. (Australia and New Zealand)
CISPR 22	Limits and methods of measurement of Radio Disturbance Characteristics of Information Technology Equipment. (International)
CISPR 24	Information Technology Equipment – Immunity Characteristics – Limits and Methods of Measurement. (International)
VCCI V-3, V-4	Voluntary Control for Interference by Information Technology Equipment. (Japan)
KN-22, KN-24	Korean Communications Commission – Framework Act on Telecommunications and Radio Waves Act. (South Korea)
CNS 13438	Bureau of Standards, Metrology and Inspection. (Taiwan)

FCC Declaration of Conformity

This device complies with Part 15 of the FCC Rules. Operation is subject to the following two conditions: (1) this device may not cause harmful interference, and (2) this device must accept any interference received, including interference that may cause undesired operation.

For questions related to the EMC performance of this product, contact:

Intel Corporation, 5200 N.E. Elam Young Parkway, Hillsboro, OR 97124
1-800-628-8686

This equipment has been tested and found to comply with the limits for a Class B digital device, pursuant to Part 15 of the FCC Rules. These limits are designed to provide reasonable protection against harmful interference in a residential installation. This equipment generates, uses, and can radiate radio frequency energy and, if not installed and used in accordance with the instructions, may cause harmful interference to radio communications. However, there is no guarantee that interference will not occur in a particular installation. If this equipment does cause harmful interference to

radio or television reception, which can be determined by turning the equipment off and on, the user is encouraged to try to correct the interference by one or more of the following measures:

- Reorient or relocate the receiving antenna.
- Increase the separation between the equipment and the receiver.
- Connect the equipment to an outlet on a circuit other than the one to which the receiver is connected.
- Consult the dealer or an experienced radio/TV technician for help.

Any changes or modifications to the equipment not expressly approved by Intel Corporation could void the user's authority to operate the equipment.

Tested to comply with FCC standards for home or office use.

Canadian Department of Communications Compliance Statement

This digital apparatus does not exceed the Class B limits for radio noise emissions from digital apparatus set out in the Radio Interference Regulations of the Canadian Department of Communications.

Le présent appareil numérique n'émet pas de bruits radioélectriques dépassant les limites applicables aux appareils numériques de la classe B prescrites dans le Règlement sur le brouillage radioélectrique édicté par le ministère des Communications du Canada.

Japan VCCI Statement

Japan Statement translation: This is a Class B product based on the standard of the Voluntary Control Council for Interference from Information Technology Equipment (VCCI). If this is used near a radio or television receiver in a domestic environment, it may cause radio interference. Install and use the equipment according to the instruction manual.

この装置は、情報処理装置等電波障害自主規制協議会（VCCI）の基準に基づくクラスB情報技術装置です。この装置は、家庭環境で使用することを目的としていますが、この装置がラジオやテレビジョン受信機に近接して使用されると、受信障害を引き起こすことがあります。
取扱説明書に従って正しい取り扱いをして下さい。

Korea Class B Statement

Korea Class B Statement translation: This equipment is for home use, and has acquired electromagnetic conformity registration, so it can be used not only in residential areas, but also other areas.

이 기기는 가정용(B급) 전자파적합기기로서 주로 가정에서 사용하는 것을 목적으로 하며, 모든 지역에서 사용할 수 있습니다.

Ensure Electromagnetic Compatibility (EMC) Compliance

Before computer integration, make sure that the power supply and other modules or peripherals, as applicable, have passed Class B EMC testing and are marked accordingly.

Pay close attention to the following when reading the installation instructions for the host chassis, power supply, and other modules:

- Product certifications or lack of certifications
- External I/O cable shielding and filtering
- Mounting, grounding, and bonding requirements
- Keying connectors when mating the wrong connectors could be hazardous









If the power supply and other modules or peripherals, as applicable, are not Class B EMC compliant before integration, then EMC testing may be required on a representative sample of the newly completed computer.

Product Certifications

Board-Level Certifications

Intel Desktop Board DZ68ZV has the regulatory compliance marks shown in Table 22.

Table 22. Regulatory Compliance Marks

Description	Mark
UL joint US/Canada Recognized Component mark. Includes adjacent UL file number for Intel Desktop Boards: E210882.	
FCC Declaration of Conformity logo mark for Class B equipment.	
CE mark. Declaring compliance to European Union (EU) EMC directive, Low Voltage directive, and RoHS directive.	
Australian Communications Authority (ACA) and New Zealand Radio Spectrum Management (NZ RSM) C-tick mark. Includes adjacent Intel supplier code number, N-232.	
Japan VCCI (Voluntary Control Council for Interference) mark.	
Korea Certification mark. Includes an adjacent KCC (Korean Communications Commission) certification number: KCC-REM-CPU-DZ68ZV.	
Taiwan BSMI (Bureau of Standards, Metrology and Inspections) mark. Includes adjacent Intel company number, D33025.	
Printed wiring board manufacturer's recognition mark. Consists of a unique UL recognized manufacturer's logo, along with a flammability rating (solder side).	V-0
China RoHS/Environmentally Friendly Use Period Logo: This is an example of the symbol used on Intel Desktop Boards and associated collateral. The color of the mark may vary depending upon the application. The Environmental Friendly Usage Period (EFUP) for Intel Desktop Boards has been determined to be 10 years.	

Chassis- and Component-Level Certifications

Ensure that the chassis and certain components; such as the power supply, peripheral drives, wiring, and cables; are components certified for the country or market where used. Agency certification marks on the product are proof of certification. Typical product certifications include:

In Europe

The CE mark indicates compliance with all applicable European requirements. If the chassis and other components are not properly CE marked, a supplier's Declaration of Conformity statement to the European EMC directive, Low Voltage directive (as applicable), and ROHS directive, should be obtained. Additionally, other directives, such as the Radio and Telecommunications Terminal Equipment (R&TTE) directive may also apply depending on product features.

In the United States

A certification mark by a Nationally Recognized Testing Laboratory (NRTL) such as UL, CSA, or ETL signifies compliance with safety requirements. Wiring and cables must also be UL listed or recognized and suitable for the intended use. The FCC Class B logo for home or office use signifies compliance with electromagnetic interference (EMI) requirements.

In Canada

A nationally recognized certification mark such as CSA or cUL signifies compliance with safety requirements. The Industry Canada statement on page 88 of this product guide demonstrates compliance with Canadian EMC regulations.

Chassis and Component Certifications

Ensure that the chassis and certain components; such as the power supply, peripheral drives, wiring, and cables; are components certified for the country or market where used. Agency certification marks on the product are proof of certification. Typical product certifications include:

In Europe

The CE marking signifies compliance with all applicable European requirements. If the chassis and other components are not properly CE marked, a supplier's Declaration of Conformity statement to the European EMC directive and Low Voltage directive (as applicable), should be obtained. Additionally, other directives, such as the Radio and Telecommunications Terminal Equipment (R&TTE) directive may also apply depending on product features.

In the United States

A certification mark by a Nationally Recognized Testing Laboratory (NRTL) such as UL, CSA, or ETL signifies compliance with safety requirements. Wiring and cables must also be UL listed or recognized and suitable for the intended use. The FCC Class B logo for home or office use signifies compliance with electromagnetic interference (EMI) requirements.

In Canada

A nationally recognized certification mark such as CSA or cUL signifies compliance with safety requirements. The Industry Canada statement on page 88 of this product guide demonstrates compliance with Canadian EMC regulations.

ENERGY STAR*, e-Standby, and ErP Compliance

The US Department of Energy and the US Environmental Protection Agency have continually revised the ENERGY STAR requirements. Intel has worked directly with these two governmental agencies in the definition of the new requirements.

Intel Desktop Board DZ68ZV meets the following program requirements in an adequate system configuration, including appropriate selection of an efficient power supply:

- Energy Star v5.0, category D
- EPEAT
- Korea e-Standby
- European Union Energy-related Products Directive 2009 (ErP)

For information about ENERGY STAR requirements and recommended configurations, go to <http://www.intel.com/go/energystar>.