

# Intel® Desktop Board DZ77GA-70K Integration Guide

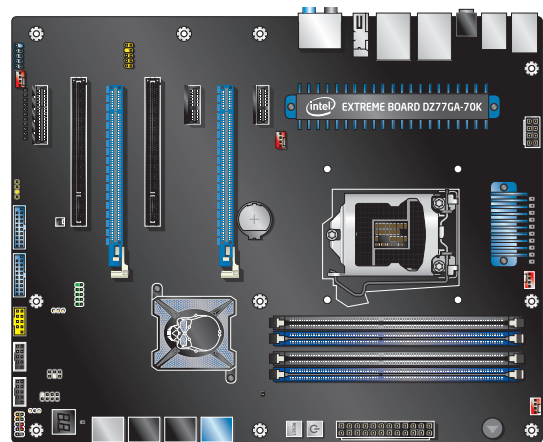

This guide contains basic instructions for installing the desktop board in a compatible chassis. For a complete description of the board and its features, refer to the Technical Product Specification at: <http://www.intel.com/products/motherboard>.



The layout of your board may differ slightly from that shown.



G53658-002

## Before You Begin

- ⚠️ Follow these guidelines before you begin building your system:**
- Electrostatic discharge (ESD) can damage components. Perform the procedures described in this guide only at an ESD workstation using an antistatic wrist strap and a conductive foam pad. If such a station is not available, you can provide some ESD protection by wearing an antistatic wrist strap and attaching it to a metal part of the computer chassis.
  - Always follow the steps in each procedure in the listed order.
  - Set up a log to record information about your computer such as serial numbers, installed options, and BIOS configuration.

### Installation Precautions

- When you install the desktop board, observe all warnings and cautions in this guide. To avoid injury, be careful of:
- Sharp pins on headers and connectors
  - Rough edges and sharp corners on the chassis
  - Damage to wires that could cause a short circuit

### Observe Safety and Regulatory Requirements

Read and follow the instructions in this guide and the instructions supplied with the chassis and associated devices. If you do not follow these instructions and the instructions provided by the chassis and device suppliers, you increase your safety risk and possibility of noncompliance with regional laws and regulations.

## 1 Install the I/O Shield

Place the I/O shield inside the chassis and press it into place so that it fits tightly and securely. Use caution so you do not deform the I/O shield.

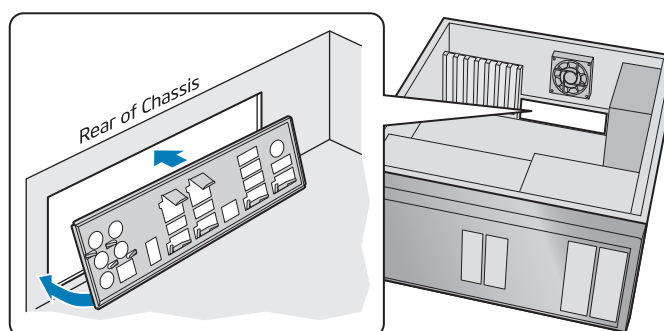

Reference chassis shown, your chassis may differ.

## 2 Install the Desktop Board

### A. Install Standoffs

Ten standoffs should be installed into the chassis before installing the desktop board. Locate the threaded standoff holes that match the desktop board, and install a standoff at each location indicated by the RED circles.

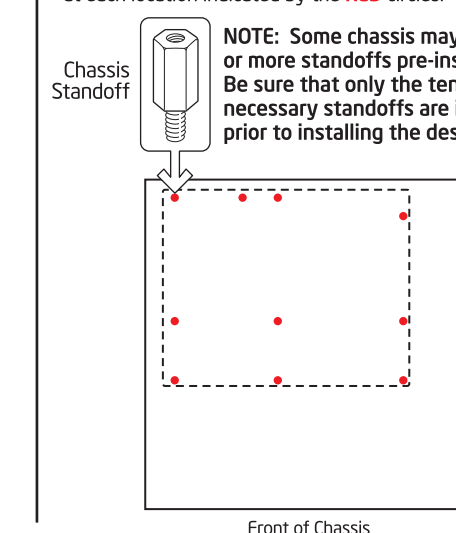

**NOTE:** Some chassis may have one or more standoffs pre-installed. Be sure that only the ten necessary standoffs are installed prior to installing the desktop board.

### B. Install the Desktop Board

Install the desktop board by aligning the back panel with the I/O shield and securing the board to the standoffs using the screws provided with your chassis.

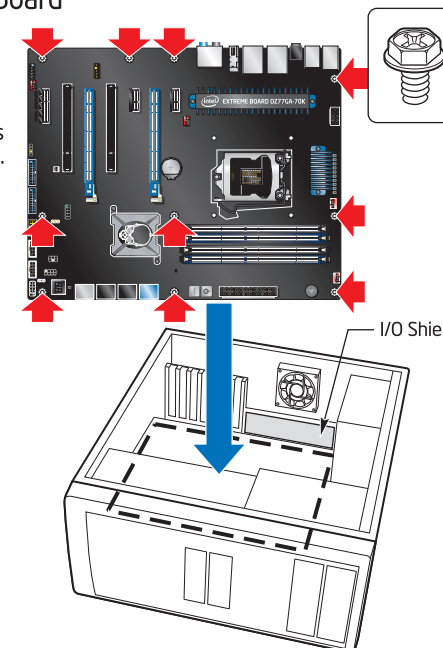

## 3 Install a Processor

For a list of processors this board supports, go to: <http://processormatch.intel.com>.

### A. Unlatch the Socket Lever

Push the lever down and away from the socket to release it.

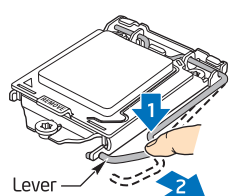

### B. Open the Load Plate

**A** Rotate the socket lever to lift the load plate away from the socket.

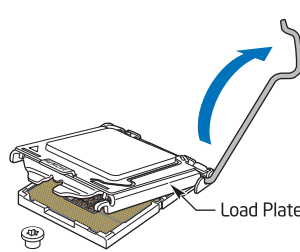

**B** Make sure the load plate is in the fully open position.

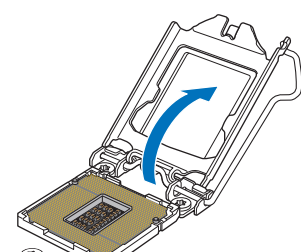

**⚠️** When opening the socket, DO NOT TOUCH the gold socket contacts.

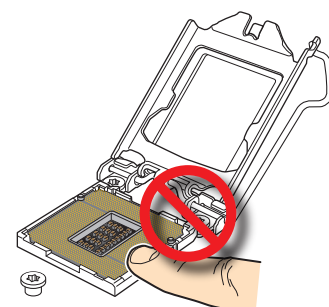

**⚠️** When unpacking a processor, hold by the edges only to avoid touching the gold contacts.

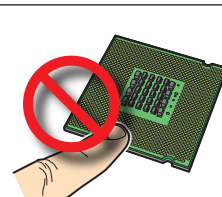

### C. Install the Processor

**⚠️** The processor must align correctly with the socket before installation. DO NOT DROP the processor into the socket.

**A** Hold the processor with your thumb and index finger as shown to align your fingers with the socket cutouts.

**B** Make sure that the processor Pin 1 indicator (gold triangle) is aligned with the Pin 1 chamfer on the socket.

**C** Make sure that the notches on the processor align with the posts on the socket.

**D** Lower the processor straight down without tilting or sliding it in the socket.

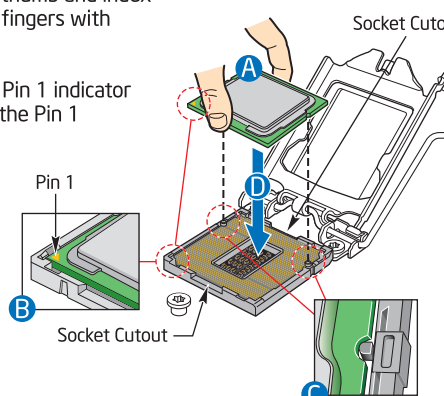

### D. Close the Load Plate and Secure the Socket Lever

**A** Carefully lower the load plate and make sure it slides under the shoulder screw cap as the lever is lowered.

**B** Continue to lower the lever and the socket cover will pop off.

**C** Latch the socket lever under the load plate tab.

**D** Pick up the socket cover and remove it from the board.

**NOTE:** Save the socket cover and replace it if the processor is removed.

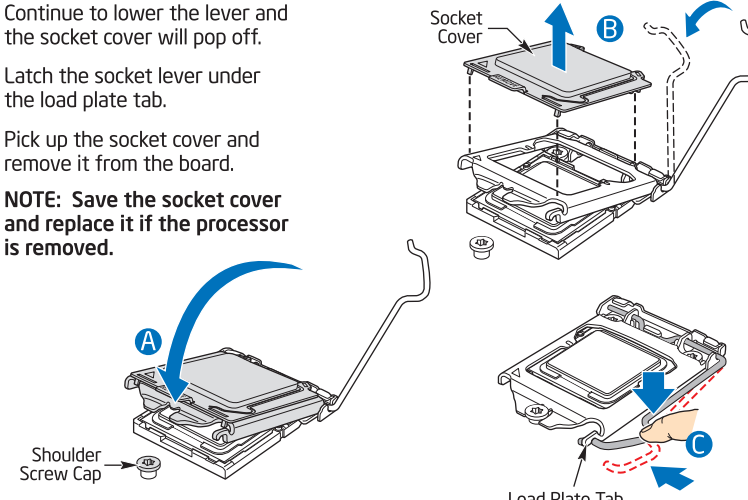

## 4 Install a Heatsink

**NOTE:** Heatsinks that come with boxed Intel® processors use pre-applied thermal interface material (TIM) and do not need thermal grease. If you install a different heatsink, refer to the manufacturer's instructions.

**⚠️** Do not touch or disturb the TIM on the heatsink during installation. Ensure that the fan power cable is on the side closest to the processor fan header.

**A** Place the heatsink onto the processor socket. Ensure that the fan power cable is on the side closest to the processor fan header.

**B** Align the four fasteners with the corresponding board holes. Ensure that the fastener slots are pointing perpendicular to the heatsink.

**C** While pressing down on the heatsink, press down on the top of the fasteners with your thumb to lock into place. Ensure that all four fasteners are secured.

**D** Connect the heatsink fan power cable to the processor fan header.

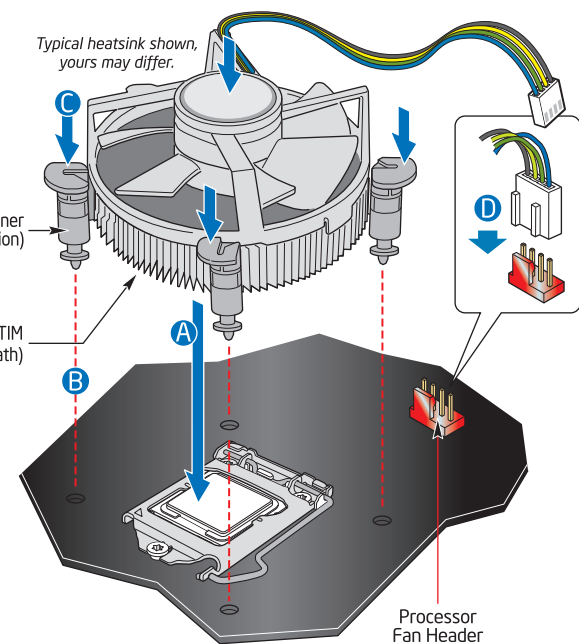

## 5 Install System Memory

**NOTE:** This desktop board supports 240-pin DDR3 DIMMs only.

For a list of tested memory go to: <http://www.intel.com/support/go/buildit>.

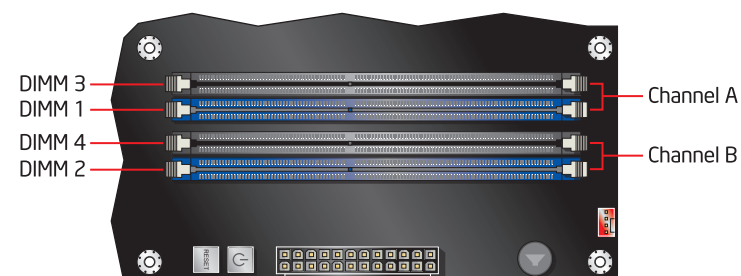

Minimum memory: 1 GB 1066 MHz DDR3 DIMM.  
Memory should be installed in DIMM number order:

- For single-channel operation, populate Slot 1 or Slots 1 and 3.
- For dual-channel operation, populate Slot 1 and Slot 2 or Slots 1, 2, 3, and 4.

For best performance, DIMM pairs should be identical in size, speed, and organization.

**⚠️** Do not touch the gold contacts when handling or installing DIMMs.

**A** Push both socket levers outward to the open position.

**B** Position the DIMM above the socket, aligning the small notch at the bottom edge of the DIMM with the key in the socket.

**C** Insert the bottom edge of the DIMM into the socket.

**D** With even pressure, push down on the top edge of the DIMM until the socket levers snap into place.

**E** Ensure that both socket levers are in the closed position.

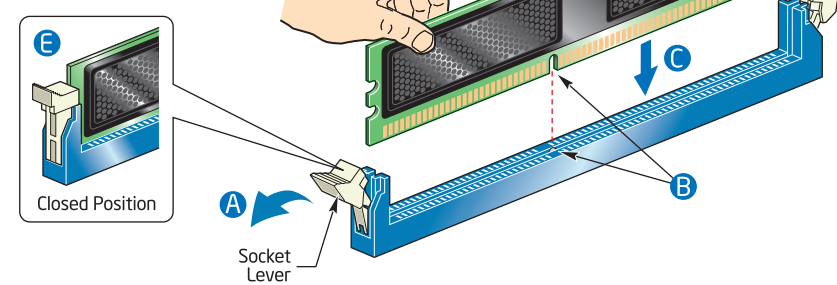

## 6 Connect Chassis Fans

This desktop board has three fan headers for connecting chassis fans. See the details below for connecting either a 3-wire or a 4-wire fan to the desktop board fan headers.

**NOTE:** The pin numbering for the fan connectors is shown for ease of installation.

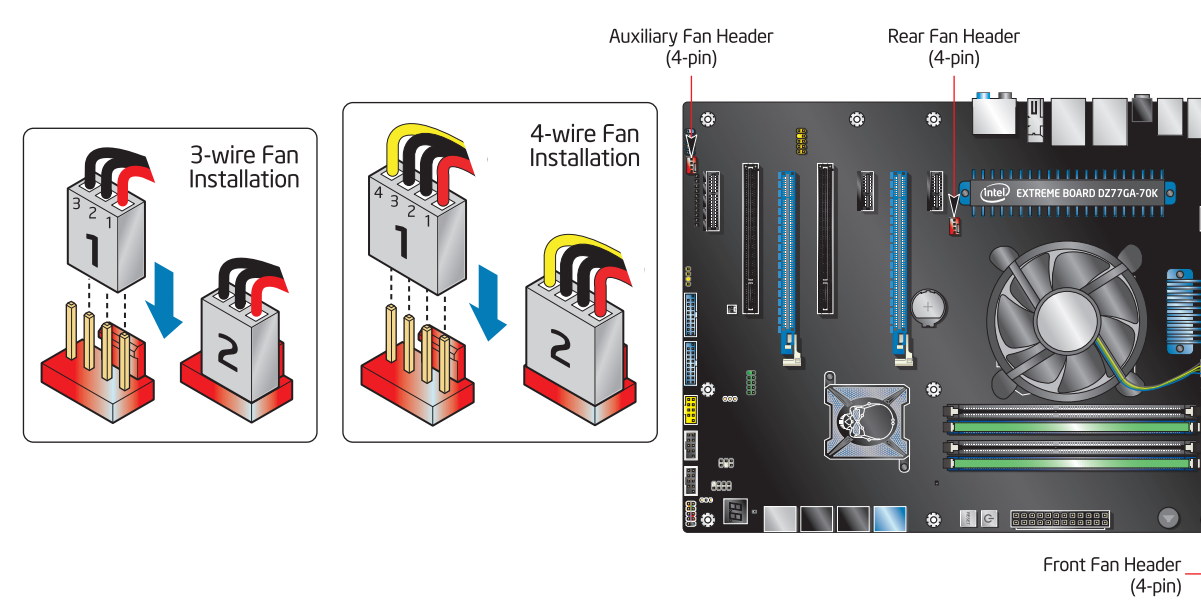

## 7 Connect Chassis Front Panel Cables

Make the front panel connections as shown in the diagram below.

**NOTE:** This desktop board provides two options for connecting the front panel power LED; only make one connection.

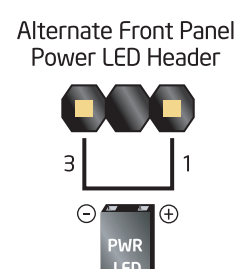
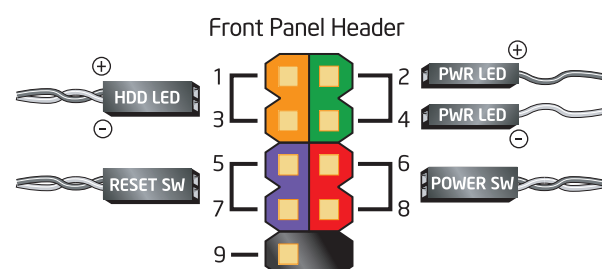

Your chassis cables may vary in appearance and labeling depending upon the chassis model.



## 8 Install a PCI Express\* x16 Graphics Card (Optional)

### A. Install a PCI Express x16 Graphics Card

**A** Place a card in the Primary PCI Express x16 connector and press down on the card until it is completely seated in the connector and the card retention notch on the card snaps into place around the retention mechanism pin on the connector.

**B** Secure the card's metal bracket to the chassis back panel with a screw.

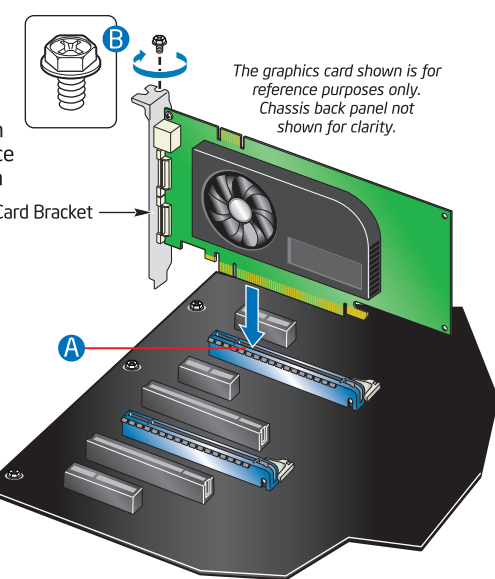

### B. Install and Link a Second PCI Express x16 Graphics Card

**A** Place the second card in the Secondary PCI Express x16 connector and press down on the card until it is completely seated in the connector and the card retention notch on the card snaps into place around the retention mechanism pin on the connector.

**B** Secure the card's metal bracket to the chassis back panel with a screw.

**C** Link the two cards with a Bridge for NVIDIA® SLI® or AMD® CrossFireX® configurations.

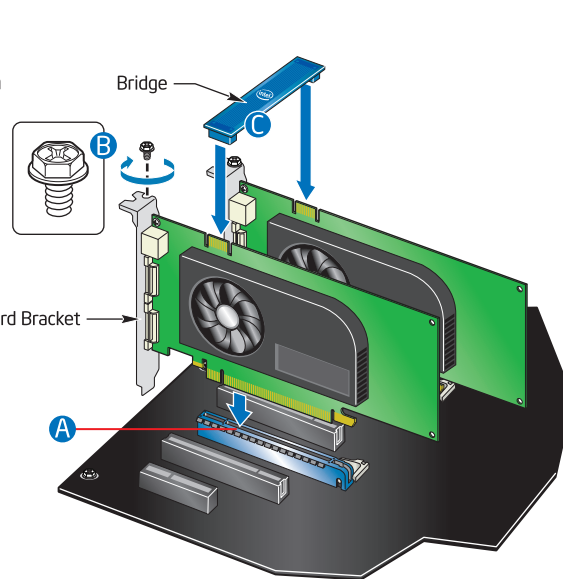

### C. Remove a PCI Express x16 Graphics Card

**A** Remove the screw that secures the card's metal bracket to the chassis back panel.

**B** Push the card ejector lever down using the tip of a pencil or similar tool in the notch. This will release the card from the connector.

**C** Pull the card straight up to remove it.

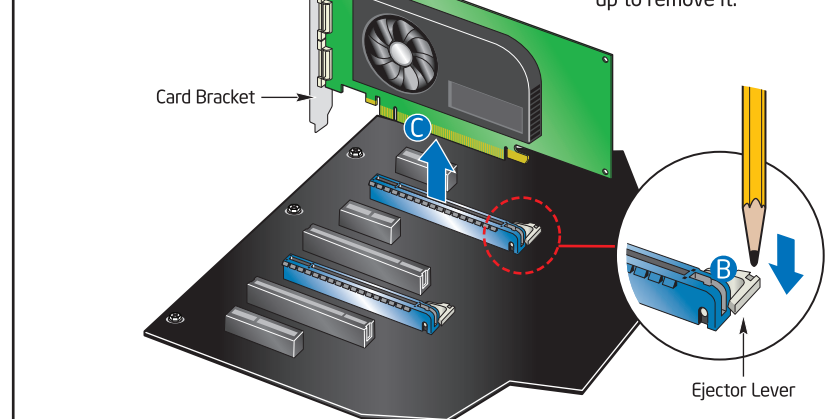

## 9 Install and Connect SATA Devices

- Install your SATA devices (Hard Disk Drive, Optical Drive, etc.). See the documentation that came with your chassis or SATA device for device installation.
- Connect both ends of the SATA data cable, one end to an available SATA port on the desktop board and the other to the connector at the rear of the SATA device.
- Connect the SATA power cable from the power supply to the power connector at the rear of the SATA device.

Repeat this procedure for each SATA device.

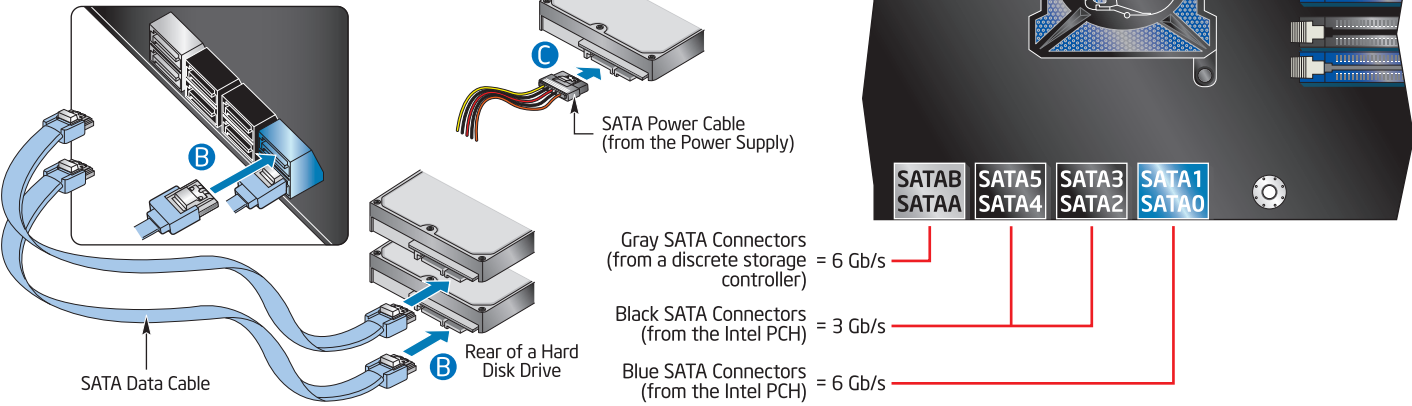

## 12 Install the WiFi/Bluetooth\* Module (Optional)

- Remove the plastic cover from an empty 5-1/4" drive bay in the chassis bezel.
- Remove the metal filler plate from the internal drive bay.
- Remove the paper backing covering the adhesive on the back of the WiFi/Bluetooth Module and attach the module to the back side of the plastic drive bay cover.
- Connect one end of the USB cable to the connector on the front of the module.
- Reinstall the plastic drive bay cover in the chassis bezel while routing the USB cable into the chassis through the empty drive bay.
- Connect the free end of the USB cable to an unused front panel USB 2.0 connector on the desktop board.

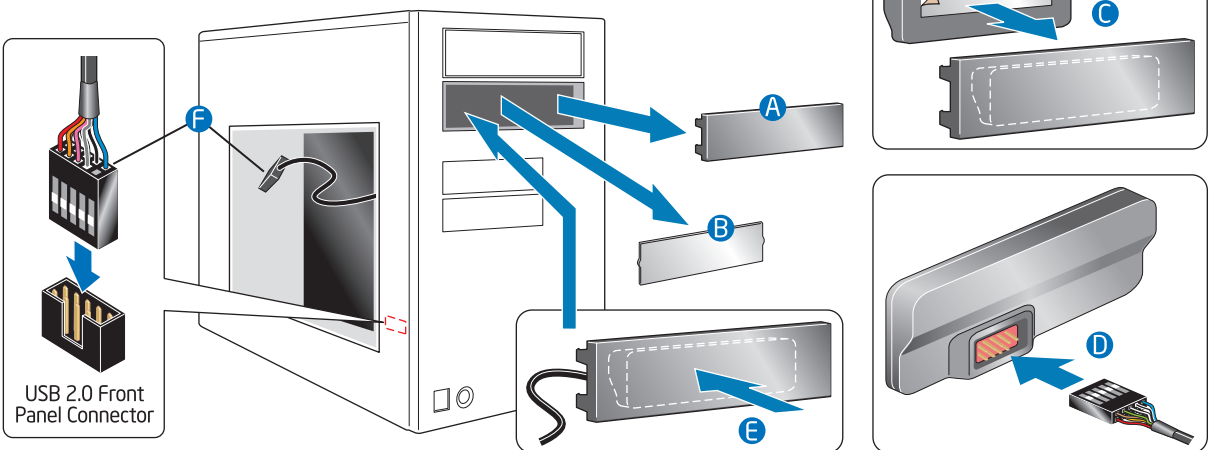

## 10 Make Power Connections

- Connect the 2 x 4 power supply cable to the matching 2 x 4 power connector on the board.
- Connect the 2 x 12 power supply cable to the matching 2 x 12 power connector on the board. Your power supply may have a 2 x 10 power cable, if so, connect as shown.
- Ensure that the voltage setting on the rear of the power supply is set correctly.

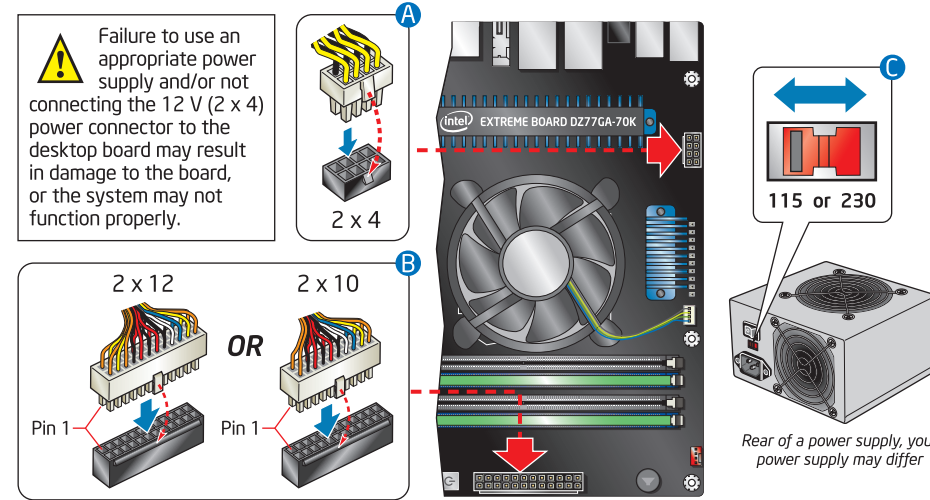

## 11 Install the USB 3.0 Front Panel Hub (Optional)

- Remove the filler panel tray from an empty 3-1/2" drive bay in the chassis bezel. If the tray has a bezel, remove it prior to installing the USB 3.0 Front Panel Hub.
- Attach the USB 3.0 Front Panel Hub to the tray using four screws.
- Route the cable through the opening and install the hub in the chassis.
- Connect the free end of the USB cable to an unused front panel USB 3.0 connector on the desktop board.

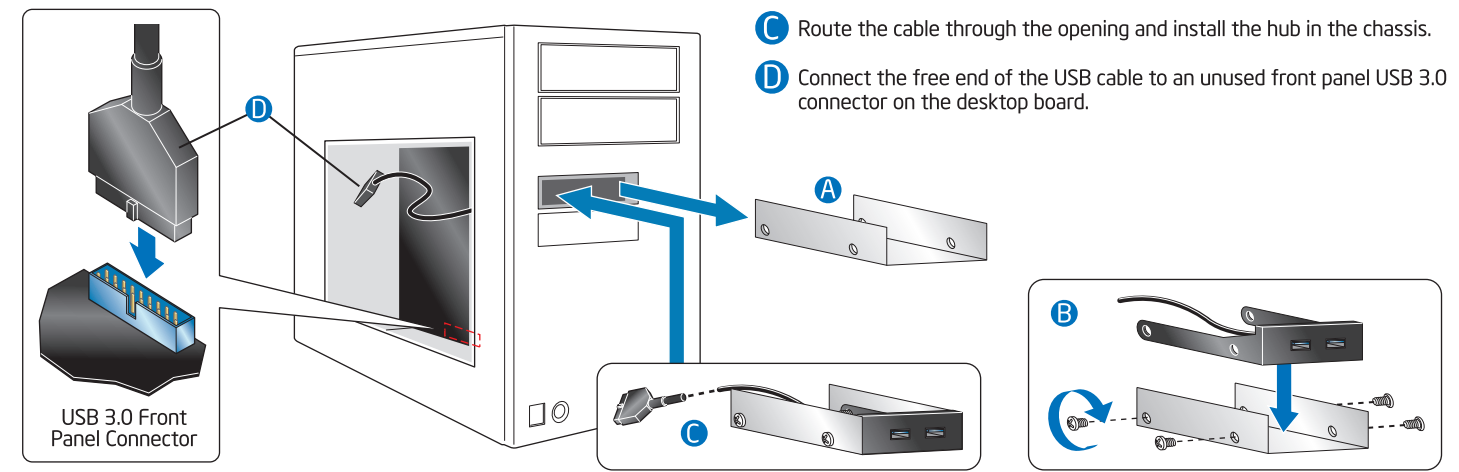

## 13 Finishing up

- Connect a mouse and keyboard using any combination of the available USB ports and the PS/2 port.
- Connect a monitor using the available video port.
- Connect the AC power cord to the back of the chassis and to a wall outlet.

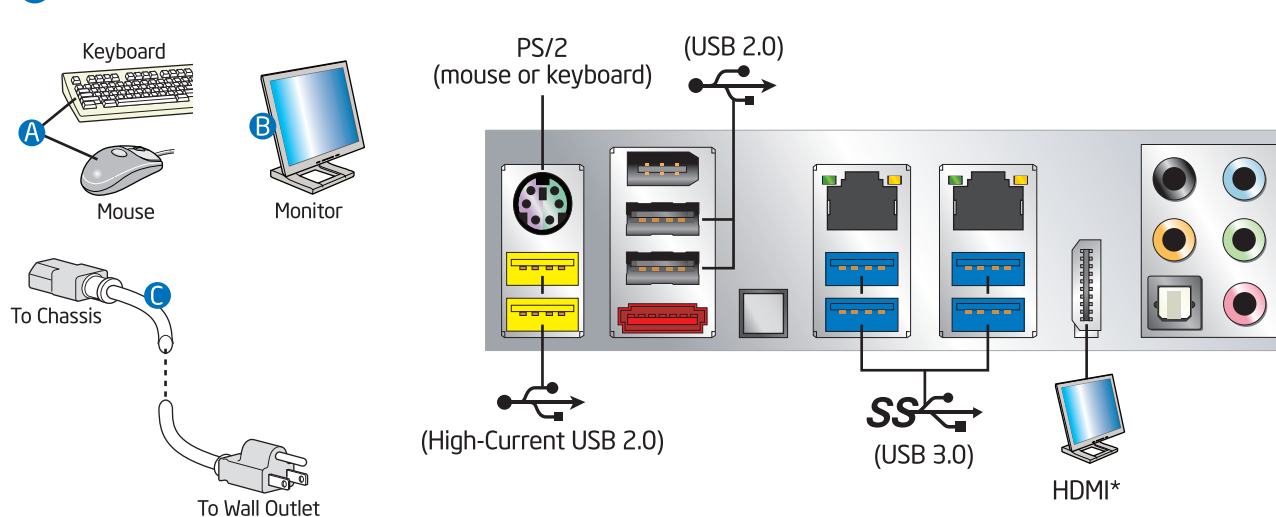

## 14 Software

- Turn on your computer and install an operating system.
- Insert the Intel® Express Installer DVD to install the necessary software to complete your desktop board integration. Go to: <http://downloadcenter.intel.com> to download the latest drivers.
- (Optional) For information on configuring your system for RAID, refer to the Intel® Rapid Storage Technology User Guide at: [http://www.intel.com/p/en\\_US/support/highlights/chpsts/ims](http://www.intel.com/p/en_US/support/highlights/chpsts/ims).

## Troubleshooting

### If your system fails to boot:

- Ensure that the 2 x 4 power supply cable is plugged into the 12 V (2 x 4) processor core voltage connector on the desktop board.
- Disconnect all power and remove and re-insert the processor, memory, and any add-in cards to make sure they are fully seated. Restart the system.
- Remove any non-essential hardware components, reconnect the power, and restart the system.

If your system still does not boot, go to: [http://www.intel.com/p/en\\_US/support/](http://www.intel.com/p/en_US/support/), select product support for Intel® Desktop Board DZ77GA-70K, and then select "Troubleshooting system 'no boot' issues". This web site contains extensive information to help you solve non-boot problems including a **No Boot Wizard**.

### Beep Codes

When a repeating beep code is heard and your system does not boot or display video, the beeps indicate the following:

| Beep Pattern                                                                                         | Problem           |
|------------------------------------------------------------------------------------------------------|-------------------|
| Two beeps (beep, beep [pause], beep, beep)                                                           | No video detected |
| Three beeps (beep, beep, beep [pause])<br>This beep pattern repeats until the system is powered off. | Memory error      |
| High/Low beeps (high, low, high, low, high, low, high, low)                                          | CPU thermal trip  |

For more information, go to: <http://www.intel.com/support/motherboards/desktop/sb/cs-010249.htm>.

## Safety and Regulatory Information

### Battery Warning

Risk of explosion if the battery is replaced with an incorrect type. Batteries should be recycled where possible. Disposal of used batteries must be in accordance with local environmental regulations.

### FCC Declaration of Conformity

This device complies with Part 15 of the FCC Rules. Operation is subject to the following two conditions: (1) this device may not cause harmful interference, and (2) this device must accept any interference received, including interference that may cause undesired operation.

For questions related to the EMC performance of this product, contact Intel Corporation, 5200 N.E. Elam Young Parkway, Hillsboro, OR 97124 1-800-628-8686.

### Canadian Department of Communications Compliance Statement

This digital apparatus does not exceed the Class B limits for radio noise emissions from digital apparatus set out in the Radio Interference Regulations of the Canadian Department of Communications.

Le présent appareil numérique n'émet pas de bruits radioélectriques dépassant les limites applicables aux appareils numériques de la classe B prescrites dans le Règlement sur le brouillage radioélectrique édicté par le ministère des Communications du Canada.

### Japan VCCI Statement

この装置は、情報処理装置等電波障害自主規制協議会（VCCI）の基準に基づきクラスB情報技術装置です。この装置は、家庭環境で使用することを目的としていますが、この装置がラジオやテレビジョン受信機に近接して使用されると、受信障害を引き起こすことがあります。取扱説明書に従って正しい取り扱いをして下さい。

### Korea Class B Statement

이 기기는 가정용(급) 전자파적합기로서 주 로 가정에서 사용하는 것을 목적으로 하며, 모든 지역에서 사용할 수 있습니다.

**Korea Certification mark.** Includes an adjacent KCC (Korean Communications Commission) certification number: KCC-REM-CPU-DZ77GA-70K.

**Date of manufacture:** March 2012  
**Country of Origin:** China

**China RoHS Environmentally Friendly Use Period**  
 The Environmentally Friendly Usage Period (EFUP) for Intel Desktop Boards has been determined to be 10 years.

For detailed information about the desktop board's regulatory compliance, refer to the Technical Product Specification at: <http://www.intel.com/products/motherboard>.

## Reference

### Desktop Board Components

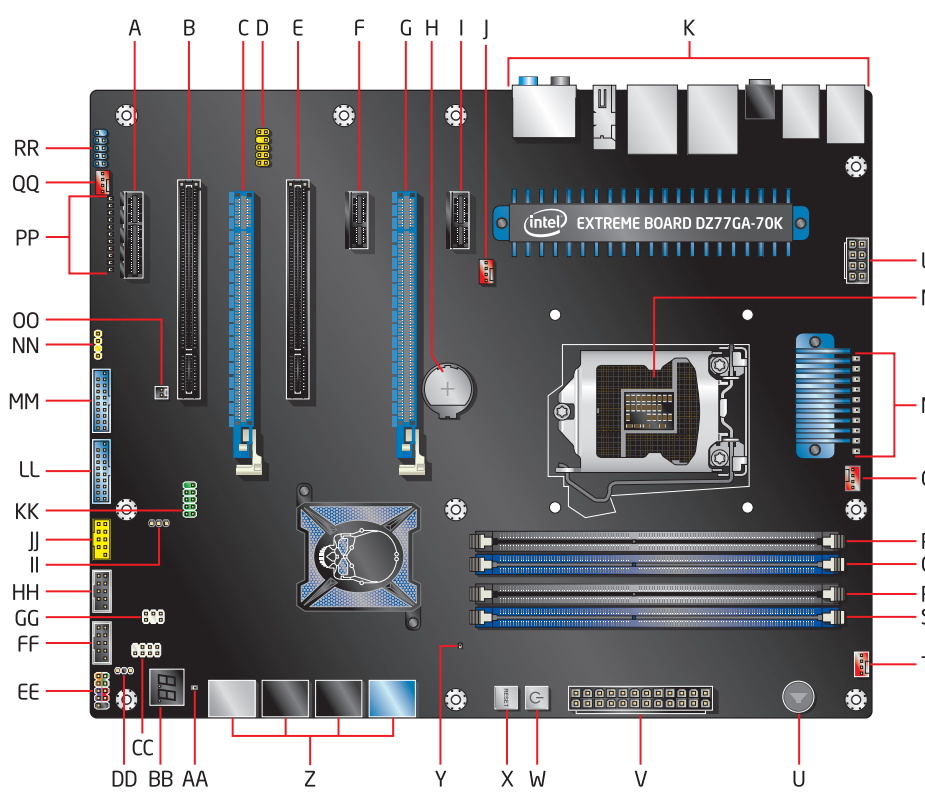

- |                                                          |                                                |
|----------------------------------------------------------|------------------------------------------------|
| A. PCI Express 2.0 x4 Connector                          | W. Power Button                                |
| B. PCI Connector                                         | X. Reset Button                                |
| C. Secondary PCI Express x16 Connector (x8 Electrically) | Y. LED 2 (Power Fault)                         |
| D. Front Panel HD Audio Header                           | Z. SATA Connectors                             |
| E. PCI Connector                                         | AA. Standby Power LED                          |
| F. PCI Express 2.0 x1 Connector                          | BB. POST Code Display LED                      |
| G. Primary PCI Express x16 Connector                     | CC. Front Panel CIR Receiver (Input) Header    |
| H. Battery                                               | DD. Alternate Front Panel Power LED Header     |
| I. PCI Express 2.0 x1 Connector                          | EE. Front Panel Header                         |
| J. Rear Fan Header                                       | FF. USB 2.0 Front Panel Connector              |
| K. Back Panel Connectors                                 | GG. Back Panel CIR Emitter (Output) Header     |
| L. 12 V Power Connector (2 x 4)                          | HH. USB 2.0 Front Panel Connector              |
| M. Processor Socket                                      | II. BIOS Configuration Jumper                  |
| N. VR Phase LEDs                                         | JJ. High-Current USB 2.0 Front Panel Connector |
| O. Processor Fan Header                                  | KK. Serial Port Header                         |
| P. DIMM 3 (Channel A, DIMM 0)                            | LL. USB 3.0 Front Panel Connector              |
| Q. DIMM 1 (Channel A, DIMM 1)                            | MM. USB 3.0 Front Panel Connector              |
| R. DIMM 4 (Channel B, DIMM 0)                            | NN. S/PDIF Header                              |
| S. DIMM 2 (Channel B, DIMM 1)                            | OO. Chassis Intrusion Header                   |
| T. Front Fan Header                                      | PP. Diagnostic LEDs                            |
| U. Speaker                                               | QQ. Auxiliary Fan Header                       |
| V. Main Power Connector (2 x 12)                         | RR. IEEE 1394a Header                          |

### Header and Connector Pinouts

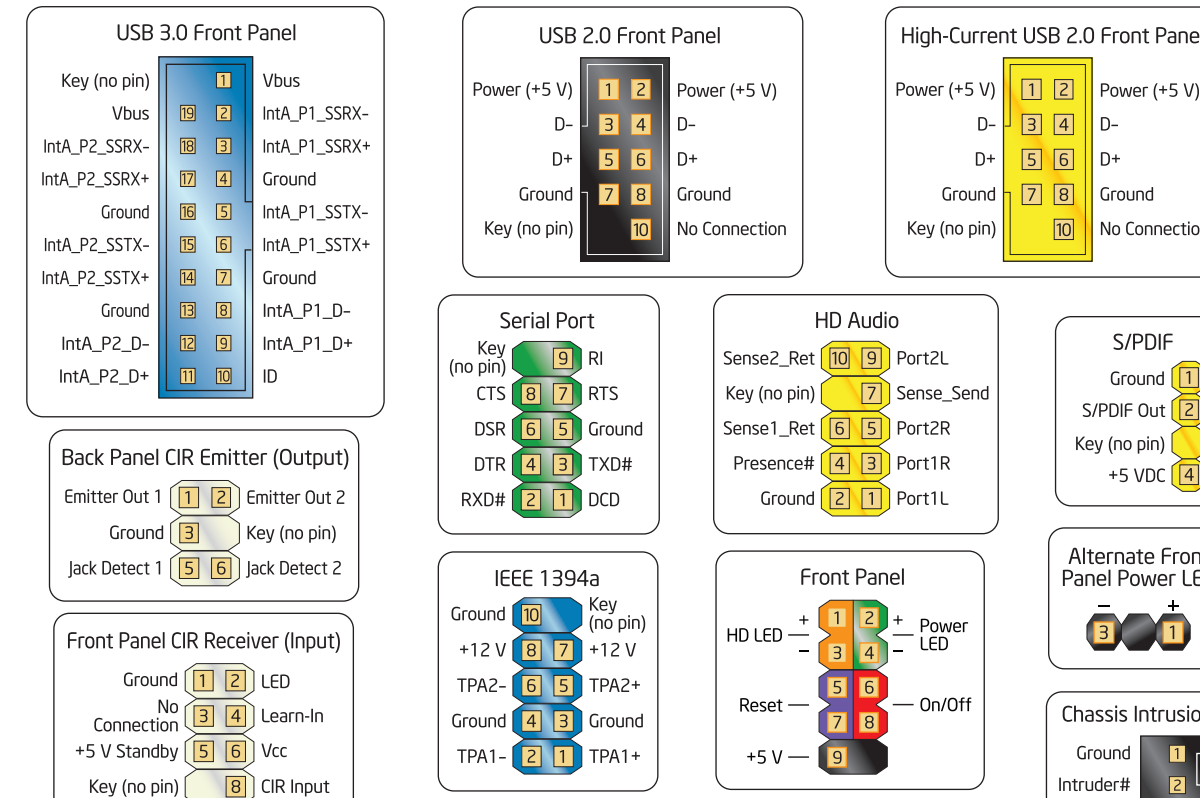

### Back Panel Connectors

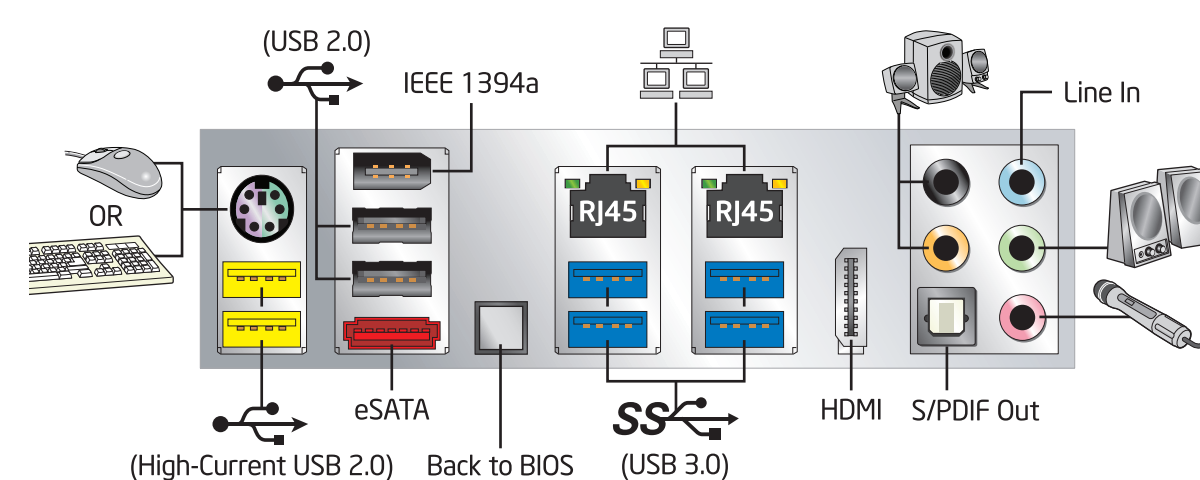

### BIOS Reference

The BIOS (Basic Input/Output System) controls the computer's boot process. The purpose of the BIOS is to identify and initialize processor, memory, hard drives, optical drives, and other hardware.

#### BIOS Settings

For a list of BIOS settings along with their purpose and options, refer to the BIOS Glossary at: <http://www.intel.com/support/motherboards/desktop/sb/cs-020304.htm>.

#### Updating the BIOS

You should update the BIOS on your board only if the newer BIOS version solves a specific problem you have. BIOS updates are available in Intel's Download Center at: <http://downloadcenter.intel.com/>. There are various methods of updating an Intel® Desktop Board BIOS to the latest version. The number of methods available for any particular board model varies, depending on drive support and BIOS update file size. For update instructions, go to: <http://www.intel.com/support/motherboards/desktop/sb/CS-022312.htm>.

#### Troubleshooting the BIOS

For tips on troubleshooting BIOS issues on Intel® Desktop Boards, refer to: <http://www.intel.com/support/motherboards/desktop/sb/CS-028780.htm>.

#### BIOS Configuration Jumper Settings:

|           |               |
|-----------|---------------|
| 1-2       | Normal        |
| 2-3       | Configuration |
| No jumper | Recovery      |

### Online Support

For more information on Intel Desktop Board DZ77GA-70K, consult the following online resources:

- |                                 |                                                                                                                                                     |
|---------------------------------|-----------------------------------------------------------------------------------------------------------------------------------------------------|
| General board information       | <a href="http://www.intel.com/products/motherboard/index.htm">http://www.intel.com/products/motherboard/index.htm</a>                               |
| Available board configurations  | <a href="http://ark.intel.com">http://ark.intel.com</a>                                                                                             |
| Supported processors            | <a href="http://processormatch.intel.com">http://processormatch.intel.com</a>                                                                       |
| Chipset information             | <a href="http://www.intel.com/products/desktop/chipsets/index.htm">http://www.intel.com/products/desktop/chipsets/index.htm</a>                     |
| BIOS and driver updates         | <a href="http://downloadcenter.intel.com/">http://downloadcenter.intel.com/</a>                                                                     |
| More integration information    | <a href="http://www.intel.com/support/go/buildit">http://www.intel.com/support/go/buildit</a>                                                       |
| Customer support                | <a href="http://www.intel.com/p/en_US/support?id=hdr+support">http://www.intel.com/p/en_US/support?id=hdr+support</a>                               |
| Intel® Rapid Storage Technology | <a href="http://www.intel.com/p/en_US/support/highlights/chpsts/ims">http://www.intel.com/p/en_US/support/highlights/chpsts/ims</a>                 |
| Tested memory                   | <a href="http://www.intel.com/support/motherboards/desktop/sb/cs-025414.htm">http://www.intel.com/support/motherboards/desktop/sb/cs-025414.htm</a> |

INFORMATION IN THIS DOCUMENT IS PROVIDED IN CONNECTION WITH INTEL® PRODUCTS. NO LICENSE, EXPRESS OR IMPLIED, BY ESTOPPEL OR OTHERWISE, TO ANY INTELLECTUAL PROPERTY RIGHTS IS GRANTED BY THIS DOCUMENT. EXCEPT AS PROVIDED IN INTEL'S TERMS AND CONDITIONS OF SALE FOR SUCH PRODUCTS, INTEL ASSUMES NO LIABILITY WHATSOEVER, AND INTEL DISCLAIMS ANY EXPRESS OR IMPLIED WARRANTY, RELATING TO SALE AND/OR USE OF INTEL PRODUCTS INCLUDING LIABILITY OR WARRANTIES RELATING TO FITNESS FOR A PARTICULAR PURPOSE, MERCHANTABILITY, OR INFRINGEMENT OF ANY PATENT, COPYRIGHT OR OTHER INTELLECTUAL PROPERTY RIGHT. Intel products are not intended for use in medical, life saving, or life sustaining applications. Intel may make changes to specifications and product descriptions at any time, without notice.

Intel® Desktop Boards may contain design defects or errors known as errata which may cause the product to deviate from published specifications. Current characterized errata are available on request.

Intel and the Intel logo are trademarks of Intel Corporation in the United States and/or other countries.

\* Other names and brands may be claimed as the property of others.  
 Copyright © 2012, Intel Corporation. All rights reserved.