

# DATA PROJECTOR

## XJ-A141/XJ-A146\*

## XJ-A241/XJ-A246\*

## XJ-A251/XJ-A256\*

\* USB Port Models

### User's Guide

- Be sure to read the precautions in the separate Setup Guide.
- Be sure to keep all user documentation handy for future reference.

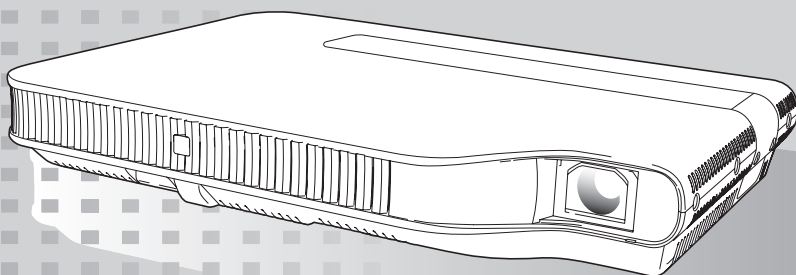

**CASIO**<sup>®</sup>

- DLP is a registered trademark of Texas Instruments of the United States.
- Microsoft, Windows, and Windows Vista are registered trademarks or trademarks of Microsoft Corporation in the United States and other countries.
- HDMI, the HDMI Logo and High-Definition Multimedia Interface are trademarks or registered trademarks of HDMI Licensing, LLC.
- XGA is a registered trademark of IBM Corporation of the United States.
- Other company and product names may be registered product names or trademarks of their respective owners.
- Portions of this product are based in part on the work of the Independent JPEG Group.

- The contents of this User's Guide are subject to change without notice.
- Copying of this manual, either in part or its entirety is forbidden. You are allowed to use this manual for your own personal use. Any other use is forbidden without the permission of CASIO COMPUTER CO., LTD.
- CASIO COMPUTER CO., LTD. shall not be held liable for any lost profits or claims from third parties arising out of the use of this product or this manual.
- CASIO COMPUTER CO., LTD. shall not be held liable for any loss or lost profits due to loss of data due to malfunction or maintenance of this product, or any other reason.
- The sample screens shown in this manual are for illustrative purposes only, and may not be exactly the same as the screens actually produced by the product.

# Contents

|   |           |
|---|-----------|
| About this manual.....  | 5         |
| <b>Projector Overview .....</b>   | <b>6</b>  |
| Projector Features and Main Functions .....                                       | 6         |
| Remote Controller and Projector Keys.....   | 8         |
| Back Terminals.....   | 9         |
| Loading Remote Controller Batteries .....   | 9         |
| Setting Up the Projector.....   | 10        |
| Setup Precautions .....   | 10        |
| <b>Connecting to an Image Output Device.....</b>                                  | <b>11</b> |
| Connecting the Analog RGB Output of a<br>Computer to the Projector.....           | 11        |
| Connecting the HDMI Output of a Video Device or<br>Computer to the Projector..... | 12        |
| Connecting to a Video Device .....  | 13        |
| Connection to a composite video output .....                                      | 13        |
| Connection to a component video output.....                                       | 13        |
| <b>Operation During Projection .....</b>  | <b>14</b> |
| Selecting the Input Source .....  | 14        |
| To select a different input source .....  | 14        |
| Resolution .....  | 14        |
| Image Operations During Projection .....  | 15        |
| Adjusting Image Brightness .....  | 15        |
| To use manual keystone correction.....  | 15        |
| Selecting the Color Mode .....  | 16        |
| Zooming an Image .....  | 16        |
| Momentarily Blanking the Image and Muting the Audio.....                          | 17        |
| Freezing an Image.....  | 17        |
| Displaying a Pointer in the Projected Image.....                                  | 18        |
| Changing the Aspect Ratio of the Projected Image .....                            | 19        |
| Adjusting the Volume Level .....  | 20        |
| To adjust the volume level .....  | 20        |
| To mute the audio.....  | 20        |

|  |           |
|--|-----------|
| Presentation Timer .....   | 21        |
| Eco Mode (Power Saving, Low Noise) .....                             | 23        |
| To select the Eco Mode .....   | 23        |
| Using the [FUNC] Key .....   | 24        |
| <b>Configuring Advanced Projector Settings .....</b>                 | <b>25</b> |
| Basic Setup Menu Operations .....                                    | 25        |
| Displaying the Setup Menu.....                                       | 25        |
| Configuring Setup Menu Settings.....                                 | 25        |
| Basic Setup Menu Example.....  | 26        |
| Direct Power On.....   | 27        |
| Password Protecting the Projector .....                              | 28        |
| Inputting a Password .....   | 28        |
| Using the Password Feature.....                                      | 28        |
| Entering the Password when Turning On the Projector .....            | 30        |
| Restoring Projector Settings to Their Initial Factory Defaults ..... | 31        |
| Setup Menu Contents .....  | 33        |
| Image Adjustment 1 Main Menu .....                                   | 33        |
| Image Adjustment 2 Main Menu .....                                   | 35        |
| Volume Adjustment Main Menu.....                                     | 35        |
| Screen Settings Main Menu.....                                       | 36        |
| Input Settings Main Menu.....  | 38        |
| Option Settings 1 Main Menu .....                                    | 39        |
| Option Settings 2 Main Menu .....                                    | 40        |
| USB Settings Main Menu (USB Port Models Only) .....                  | 42        |
| Wireless Main Menu (USB Port Models Only) .....                      | 42        |
| Operational Info Main Menu .....                                     | 42        |
| Restore All Defaults Main Menu.....                                  | 42        |
| <b>Cleaning the Projector.....</b>                                   | <b>43</b> |
| Cleaning the Projector Exterior .....                                | 43        |
| Cleaning the Lens.....   | 43        |
| Cleaning Intake and Exhaust Vents.....                               | 43        |
| <b>Troubleshooting .....</b>   | <b>44</b> |
| Indicators.....  | 44        |
| Error Indicators and Warning Messages .....                          | 44        |

|   |           |
|---|-----------|
| Projector Troubleshooting .....                 | 47        |
| <b>Appendix .....</b>                           | <b>49</b> |
| Remote Controller Signal Range .....            | 49        |
| Projection Distance and Screen Size .....       | 50        |
| Aspect Ratio Setting and Projection Image ..... | 51        |
| Supported Signals .....                         | 53        |
| Specifications .....                            | 55        |

## About this manual...

All of the operations in this manual are explained using the remote controller that comes with the projector.

# Projector Overview

This section describes the features of the projector, and explains the functions of the projector and remote controller keys.

## Projector Features and Main Functions

### XJ-A141/XJ-A146/XJ-A241/XJ-A246/XJ-A251/XJ-A256

- **Mercury-free Hybrid Light Source:**  
A CASIO-original laser and LED hybrid light source delivers high luminance from 2,500 to 3,000 lumens. This projector does not use a mercury lamp, making it environmentally friendly.
- **Slim and compact:**  
A4 file size and approximately 43 mm slim. Compact enough to install or use just about anywhere.
- **HDMI video/audio input:**  
HDMI (High Definition Multimedia Interface) input support enables direct connectivity with today's HDMI enabled notebook PCs, high-definition video devices (BD, HD DVD, DVD players, etc.), and games. The projector supports image projection and audio output from these devices.
- **Wide projection range:**  
A wide angle 2X zoom allows projection even when projector-to-screen distance is severely limited. When using a projection size of 60 inches, projection can be performed from a distance of 1.4 meters (XJ-A241/XJ-A246/XJ-A251/XJ-A256) or 1.7 meters (XJ-A141/XJ-A146).
- **A wide selection of input sources:**  
Analog RGB, composite video, component video (Y·Cb·Cr, Y·Pb·Pr), and HDMI input sources are supported.
- **Intelligent Brightness Control function (Eco Mode):**  
The projector senses surrounding light levels and adjusts projection brightness automatically as required for efficient low-power operation. (Requires "Eco Mode" setting to be set to "On (Auto)".)
- **Pointer:**  
The remote controller can be used to select one of a variety of different pointers for use during projection.
- **Direct Power On:**  
The projector can be configured to turn on automatically and start projecting as soon as it is plugged into a power outlet.

## **XJ-A241/XJ-A246/XJ-A251/XJ-A256**

- **WXGA Resolution:**

The XJ-A241/XJ-A246/XJ-A251/XJ-A256 models support WXGA (1280 × 800) resolution for optimal viewing of content formatted for today's widescreen displays. This makes it perfect for projecting images from widescreen notebook PCs and HD video input sources.

## **XJ-A146/XJ-A246/XJ-A256**

- **Projection of Data from USB Memory or a Memory Card without a Computer:**

USB memory or a memory card (using a commercially available USB card reader) can be connected directly to the projector's USB port. The projector comes with special software for converting PowerPoint presentation data to a format that can be stored to USB memory or a memory card and projected without using a computer. Images and movies also can be projected directly from USB memory or a memory card.

- **Multi Projection Camera (YC-400, YC-430) Connection:**

A CASIO Multi Projection Camera can be connected directly to the projector's USB port for fine resolution projection of documents and other images. Document camera capabilities allow projection of data without going through a computer.

- **Graphic Scientific Function Calculator Connection:**

Certain CASIO graphic scientific calculator models can be connected directly to the projector's USB port for projection of the calculator screen contents.

- **Projection of Computer Screen Contents via Wireless LAN:**

The projector comes with a wireless LAN adapter. After a wireless LAN connection is established, the contents of the computer screen can be sent to the projector for projection.

- **Support for Wireless projection from MobiShow:**

You can install AWIND's MobiShow (client software for wireless connection to a projector) on a smartphone or mobile terminal, and then use the projector to project photographs and presentation files stored in the smartphone or terminal memory.

\* Note that the type of terminal and the MobiShow version can limit certain functions or can even make projection impossible.

# Remote Controller and Projector Keys

Operations in this manual are presented based on the remote controller that comes with the projector. Major operation keys are also provided on the projector unit, so the most of the same procedures can also be performed directly on the projector.

## Remote Controller Keys

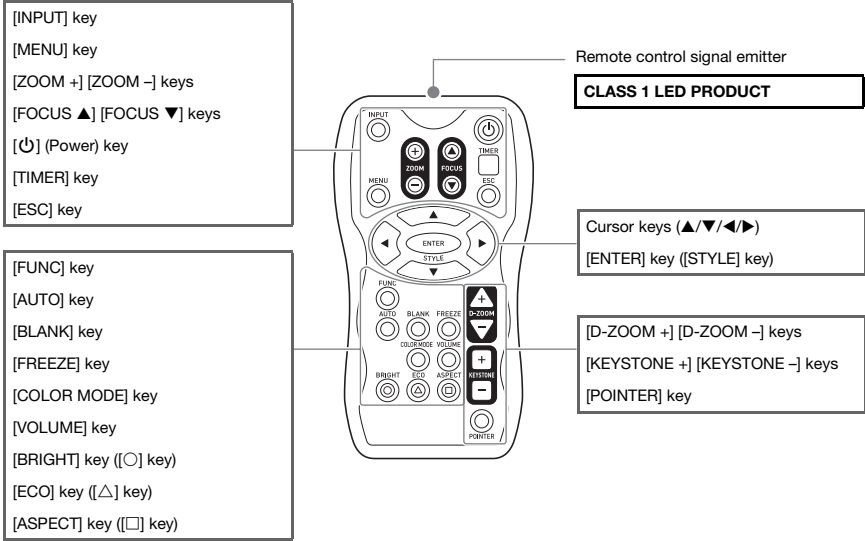

The remote controller does not come with batteries loaded. You need to load the two supplied batteries before use.



### Important!

To avoid running down the batteries, store the remote control unit so its keys are not pressed inadvertently.

## Projector Keys and Indicators

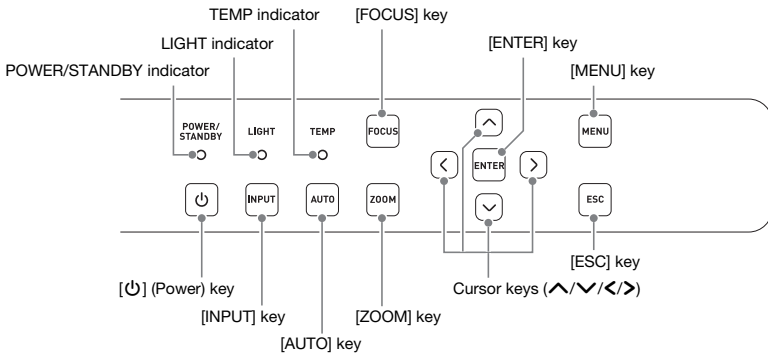



# Back Terminals

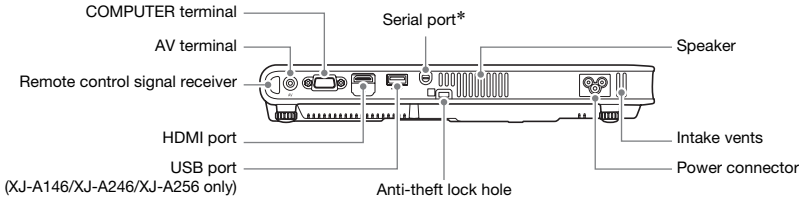

\* This serial port is for connecting a separately available special cable (YK-5) to control the projector from a computer.

# Loading Remote Controller Batteries



**Important!**

Be sure to use alkaline batteries only.



**Caution**

RISK OF EXPLOSION IF BATTERY IS REPLACED BY AN INCORRECT TYPE.  
DISPOSE OF USED BATTERIES ACCORDING TO THE INSTRUCTIONS.

- 1. Open the battery cover on the back of the remote controller.**
- 2. Load two new batteries into the case, making sure that their positive (+) and negative (-) ends are facing correctly.**

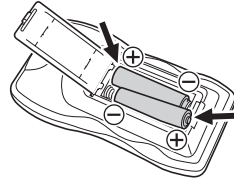
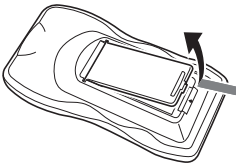

- 3. Close the battery cover on the back of the remote controller.**

## Replacing Remote Controller Batteries

Open the battery cover on the back of the remote controller, replace the old batteries with new ones, and then close the battery cover.

# Setting Up the Projector

Locate the projector on a desk, table, or stand that is firm and level. Make sure that you allow sufficient space around the sides and back of the projector for proper ventilation. The following illustrations show how the projector should be oriented for optimum projection relative to the screen.

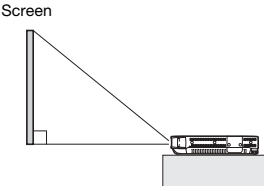
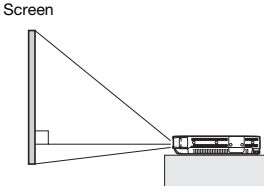
| XJ-A141/XJ-A146  | XJ-A241/XJ-A246/XJ-A251/XJ-A256   |
|--|---|
|  <p data-bbox="84 454 481 478">Make sure the projector is at a right angle to the screen.</p> |  <p data-bbox="565 454 1030 494">Position the projector so the lens side is at the edge of the table, etc.</p> |

- The projector can be configured for projection from the back of a screen. For details, see “Projection Mode” (page 37) under “Screen Settings Main Menu”.

# Setup Precautions

- Use a conveniently located power outlet that you can reach easily when you need to unplug the projector.
- Do not allow any objects to be within the area indicated by the dashed line below, which is an area within 30cm (11.8 inches) of the projector. Keep all obstacles and other objects at least 30cm away from the projector’s vents.
- Airflow from air conditioning equipment can blow the heat being exhausted from the area around the projector’s lens in a way that causes heat ripples to appear in the projected image. If this happens, adjust the airflow of the air conditioning equipment or move the projector.

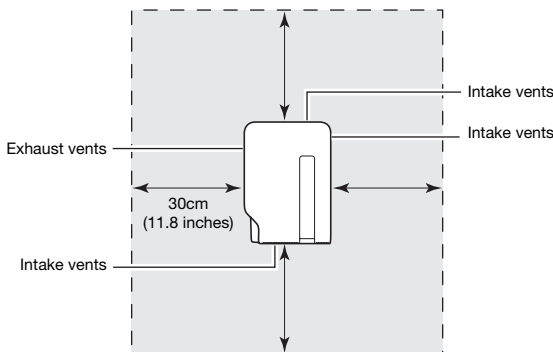

# Connecting to an Image Output Device

## Connecting the Analog RGB Output of a Computer to the Projector

Connect the projector's COMPUTER terminal to the RGB terminal of a computer as shown in the illustration below.



### Important!

- Always turn off the projector and the computer before connecting them.
- Take care so the volume level of the computer is not set too high.

### Projector

AV terminal

COMPUTER terminal

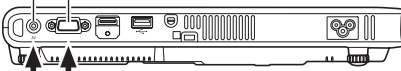

### Computer

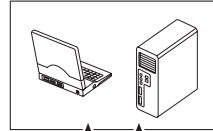

To monitor terminal  
(analog RGB output terminal)

To line output terminal

Bundled mini D-Sub cable

Audio cable (commercially available)

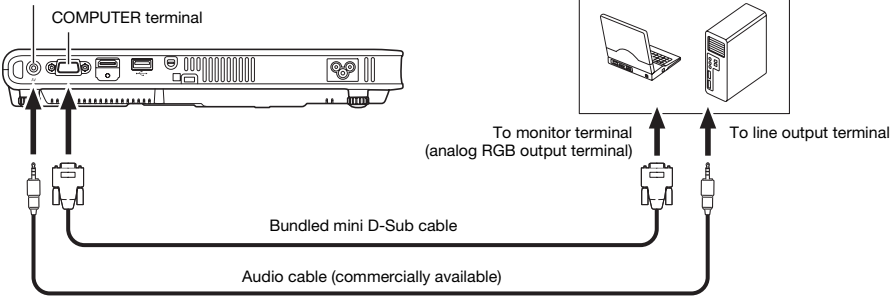

# Connecting the HDMI Output of a Video Device or Computer to the Projector

The projector supports projection and output of HDMI video and audio output from a computer or video device.



## Important!

Turn off the projector and the computer or video device before connecting them.

### Projector

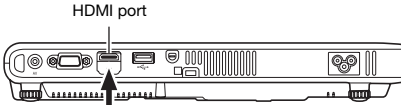

### Computer or video device

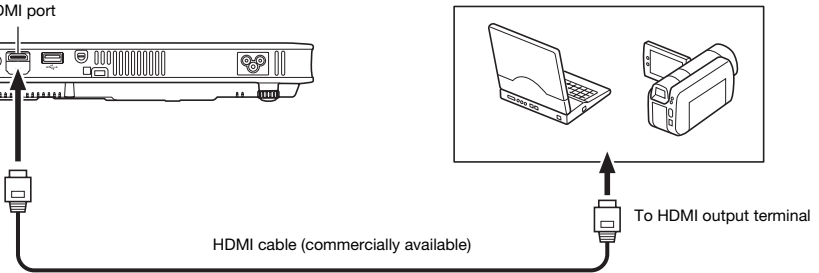
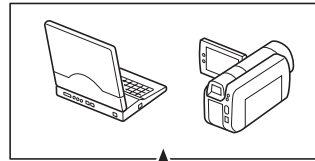

- You will need to obtain a commercially available HDMI cable with a connector that matches the terminal of the output device on one end and a connector that matches the projector's HDMI port (HDMI Type A Socket) on the other end.
- For information about HDMI video signal supported by the projector, see page 54.
- The projector supports L-PCM 32kHz, 44.1kHz, and 48kHz HDMI audio signals.

# Connecting to a Video Device

The projector is able to project images from the composite video output or component video output of a connected video device.



## Important!

Always turn off the projector and the video device before connecting them.

## Connection to a composite video output

### Projector

AV terminal

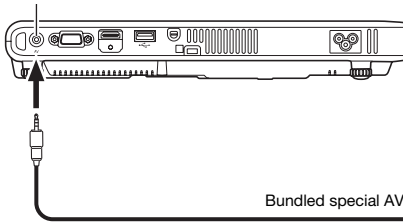

Bundled special AV cable

### Video device

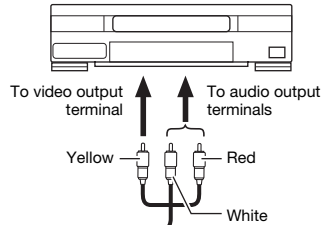

- You can use the bundled special AV cable to connect to a pin jack (RCA) type video output terminal. When connecting a video camera or other video device with a special video output terminal, use the special cable that comes with the video device. For details, see the documentation that comes with the video device.

## Connection to a component video output

### Projector

AV terminal

COMPUTER terminal

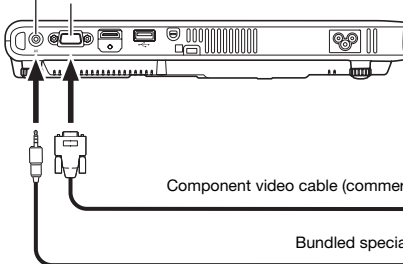

Component video cable (commercially available)

Bundled special AV cable

### Video device

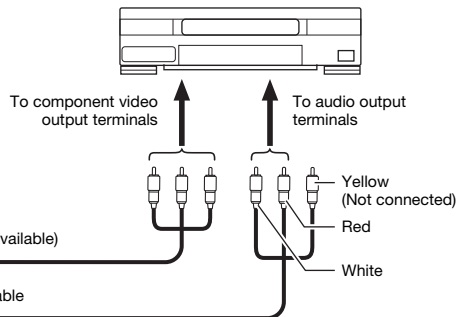

- Component video output terminals come in 3-terminal sets: Y-Cb-Cr or Y-Pb-Pr. Be sure to match the colors of the plugs on a component video cable with the colors of the terminals (Green: Y; Blue: Cb/Pb; Red: Cr/Pr).
- Note that connection only to an analog component video output terminal is supported. Connection to a digital output terminal is not supported.

# Operation During Projection

## Selecting the Input Source

Turning on the projector initially causes the same input source that was selected the last time it was turned off to be selected.

### To select a different input source

#### 1. Press the [INPUT] key.

- This displays the input source selection screen.

#### 2. Use the [▼] and [▲] keys to select the name of the input source you want to select and then press the [ENTER] key.

- The name of the input source you select appears in the upper right corner of the projection screen for a few seconds.
- The message “No signal input.” will appear if no input signal can be selected.

## Resolution

Depending on the projector model, its video resolution will be fixed at XGA (1024 × 768 pixels) or WXGA (1280 × 800 pixels). Images may appear coarse, text and other figures may be difficult to read or a moire pattern may appear when the input signal from a computer does not match the projector's video resolution. If this happens, try doing the following.

- Change the computer's output resolution setting so it matches the projector's video resolution. For information about the video resolution of your projector, see the “DLP chip” item of the “Specifications” (page 55). See the user documentation that comes with your computer for details about changing its settings.
- Change the “Aspect Ratio” setting to “True” (Applies only to models that support WXGA video resolution).  
With the “True” setting, the projector projects the input signal at its actual size (1 input source dot equal to one projector output pixel dot).  
For information about configuring the Aspect Ratio setting, see “Changing the Aspect Ratio of the Projected Image” (page 19).

# Image Operations During Projection

You can perform the following operations while projecting an image.

- Image brightness adjustment
- Manual keystone correction
- Color mode selection
- Image zooming
- Momentarily blanking the image and muting the audio
- Image freeze
- Pointer display in the projected image
- Aspect ratio switching

## Adjusting Image Brightness



### Note

(for USB port model users)

Use the setup menu (page 25) to adjust image brightness when the input source is an external device connected to the USB port or via the wireless adapter.

### 1. Press the [BRIGHT] key.

- This displays the brightness adjustment window.



### 2. Use the [◀] and [▶] keys to adjust image brightness.

### 3. To hide the window, press the [ESC] key.

## To use manual keystone correction

The projector has a keystone correction feature that prevents distortion of the projected image when projecting from an angle. The projector detects when it is at a vertical angle to the screen and performs keystone correction automatically. You can use the [KEYSTONE +] and [KEYSTONE -] keys to adjust keystone correction manually.

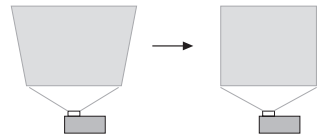

# Selecting the Color Mode

You can select from among various different color mode settings in accordance with image contents and projection conditions.



## Important!

---

The color mode cannot be selected in the following cases.

- When “Off” is selected for the Eco Mode setting (page 23)

## To change the color mode

- 1. Press the [COLOR MODE] key.**
  - This displays the color mode selection window. The currently selected color mode is the one whose button is selected (filled in).
- 2. Use the [▼] and [▲] keys to move the highlighting to the color mode you want to select, and then press the [ENTER] key.**
  - This will select the button next to the highlighted color mode name.
  - For details on what each color mode does, see “Color Mode” (page 34) under “Image Adjustment 1 Main Menu”.
- 3. To hide the window, press the [ESC] key.**

## Zooming an Image

- 1. Press the [D-ZOOM +] key.**
  - This will enlarge the center of the projected image one step.
- 2. To zoom in on the center of the projected image more, press the [D-ZOOM +] key again. To zoom out, press the [D-ZOOM -] key.**
  - Each press of [D-ZOOM +] zooms in (increases the zoom factor), while [D-ZOOM -] zooms out. Holding down either key continuously scrolls the zoom factor.
- 3. While an image is zoomed, use the [▲], [▼], [◀], and [▶] keys to scroll the view to other parts of the image.**
- 4. To exit the zoom operation, press the [ESC] key.**



## Momentarily Blanking the Image and Muting the Audio

- 1. Press the [BLANK] key.**
  - This temporarily blanks the image (projecting a black screen) and mutes the audio.
- 2. To resume normal image and sound, press the [BLANK] key (or [ESC] key).**



---

### Note

You can specify projection of a black screen or blue screen, or a logo. For details, see “Blank Screen” (page 37) under “Screen Settings Main Menu”.

## Freezing an Image

Pressing the [FREEZE] key freezes the projected image.

### To freeze the projected image

- 1. While an image is being projected from an input source, press the [FREEZE] key.**
  - This will capture the image that is on the screen at the moment you press [FREEZE] and stores it in projector memory. That image remains projected on the screen.
- 2. To restore projection of the image from an input source, press the [ESC] key.**

# Displaying a Pointer in the Projected Image

You can select from among different pointer styles, including various arrow styles, for display in the projected image. Pointers can be used during a presentation to indicate or highlight a specific part of the image.



## Note

Depending on the pointer style you are using, the pointer may not display properly when you are using keystone correction. If this happens, use the [KEYSTONE +] and [KEYSTONE -] keys to change the keystone correction value to zero.

## To display a pointer in the image

- 1. Press the [POINTER] key.**
  - This will cause a pointer to appear in the image.
  - You also can use the setup menu to specify the pointer type that appears first when you press the [POINTER] key. For details, see “Pointer” (page 40) under “Option Settings 2 Main Menu”.
- 2. Use the cursor keys to move the pointer to the location you want.**
  - Holding down a cursor key moves the cursor at high speed.
- 3. To modify the pointer as described below, press the [STYLE] key.**

| For this pointer type: | Pressing [STYLE] will change it like this: |
|------------------------|--|
|                        | →  →  →                                    |
|                        | →  →  →                                    |
|                        | →  →  →                                    |
|                        | →  →  →                                    |
|                        | Toggle between flashing and not flashing   |

## To select the pointer type

- 1. Press the [POINTER] key to display the pointer.**
- 2. Keep pressing the [POINTER] key until the pointer you want is displayed.**
  - Each press of the [POINTER] key cycles through the available pointer types.

## To clear the pointer from the image

Press the [ESC] key.

# Changing the Aspect Ratio of the Projected Image

Press the [ASPECT] key to cycle through the aspect ratio settings for the projected image.

Available settings depend on your projector model as shown below. For details about the meaning of each setting, see “Aspect Ratio” (page 36) under “Screen Settings Main Menu”.

## XJ-A241/XJ-A246/XJ-A251/XJ-A256

Pressing the [ASPECT] key will cycle through settings in accordance with the current input source as shown below.

| Input Source                 | Pressing [ASPECT] will cycle through these settings: |
|------------------------------|--|
| Video, Component, HDMI (DTV) | Normal → 16:9 → 4:3 → Letter Box                     |
| RGB, HDMI (PC)               | Normal → Full → 4:3 → True                           |

## XJ-A141/XJ-A146

Pressing the [ASPECT] key will toggle between settings in accordance with the current input source as shown below.

| Input Source                 | Pressing [ASPECT] will toggle between these settings: |
|------------------------------|---|
| Video, Component, HDMI (DTV) | Normal ↔ 16:9   |
| RGB, HDMI (PC)               | Normal ↔ Full   |



### Note

- For details about how the aspect ratio setting affects the projected image, see “Aspect Ratio Setting and Projection Image” (page 51).
- You also can change the aspect ratio setting using the setup menu. For details, see “Aspect Ratio” (page 36) under “Screen Settings Main Menu”.



### Important!

Note that enlarging or reducing the size of an image using the [ASPECT] key for commercial purposes or public presentation may infringe on the legally protected copyright of the copyright holder of the original material.

# Adjusting the Volume Level

You can use the remote controller keys to adjust the volume level of the audio that is output from the projector's speaker or the AV terminal.

## To adjust the volume level

### 1. Press the [VOLUME] key.

- This causes the [Volume] screen to appear on the projected image.



### 2. Press the [▶] key to increase the volume, or the [◀] key to lower the volume.

### 3. After the setting is the way you want, press the [ESC] key.

- This causes the [Volume] screen to disappear.



#### Note

You also can use the setup menu to adjust the volume level. For details, see “Volume Adjustment Main Menu” on page 35.

## To mute the audio

### 1. Press the [VOLUME] key.

### 2. Press the [ENTER] key.

- This stops output from the speaker.

### 3. To restore the audio, press the [VOLUME] key again.

# Presentation Timer

The presentation timer shows the amount of presentation timing remaining. You can configure the presentation times so it is displayed in the projected image.

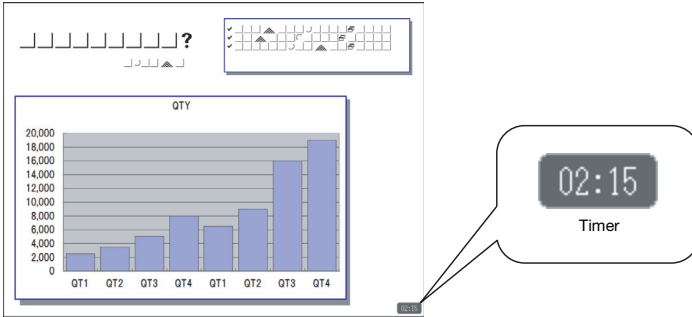

## To specify timer display position and countdown time settings

### 1. Press the [TIMER] key.

- This will cause the timer to appear in the projected image. The initial default display position is the lower right corner of the image.

### 2. While the timer is displayed, press the [TIMER] key again.

- This will cause the timer to disappear and the timer function menu to appear.

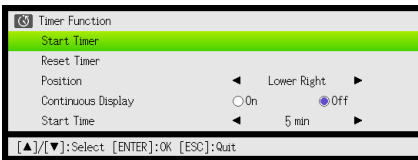

### 3. Use the [▼] key to select "Position".

### 4. Use the [◀] and [▶] keys to change the setting to the display position you want.

- Available settings are Lower Right, Upper Right, Upper Left, and Lower Left. The initial default position is Lower Right.

### 5. Use the [▼] key to select "Start Time".

### 6. Use the [◀] and [▶] keys to change the setting to the countdown start time you want.

- You can set a start time from five to 60 minutes, in five-minute steps. The initial default setting is 20 minutes.

### 7. After the settings are the way you want, press the [ESC] key.

- This will cause the timer function menu to disappear. The timer will appear in the projected image for about five seconds and then disappear (under initial settings).
- If you want the timer to remain displayed without disappearing, change the "Continuous Display" setting to "On".
- Even if "Continuous Display" is "On", you can clear the timer from the image at any time by pressing [ESC]. The timer will also disappear when you display a menu or a dialog box. To re-display the timer after it has disappeared, press [TIMER].

## To start a countdown timer operation

- 1. Press the [TIMER] key to display the timer function menu.**
  - If necessary, use the procedure under “To specify timer display position and countdown time settings” (page 21) to configure timer display position and start time settings.
- 2. Use the [▼] and [▲] keys to select “Start Timer” and then press the [ENTER] key.**
  - This will close the timer function menu and start the countdown.
  - The timer will be displayed at this time. If the timer function menu “Continuous Display” item is “Off”, the timer will disappear after about five seconds. If “On”, the timer will remain displayed. To re-display the timer after it has disappeared, press [TIMER].
  - After the countdown reaches 00:00, it will start a count up operation (from –00:01 to –60:00). The numerals of the timer display are red during a count up operation.



### Note

- If the timer is not displayed, it will appear automatically for about five seconds when the countdown time reaches 3, 2, 1, and 0 minutes. If the timer function menu “Continuous Display” item is “Off”, the timer will disappear after about five seconds. If “On”, the timer will remain displayed.
- Turning off the projector, performing the “Restore All Defaults” (page 42) operation, or performing the “Restore Menu Defaults” (page 41) operation on the Option Settings 2 main menu while a timer countdown operation is in progress will stop the countdown and return the countdown start time to the “Start Time” setting. Any other projector operations do not have any affect on the timer.

## To pause the timer countdown

- 1. While a timer countdown is in progress, press the [TIMER] key to display the timer function menu.**
- 2. Make sure that “Pause Timer” is selected and then press the [ENTER] key.**
  - This will pause the countdown and cause the timer function menu to disappear.

## To restart a paused timer countdown

- 1. While the timer countdown is paused, press the [TIMER] key to display the timer function menu.**
- 2. Make sure that “Restart Timer” is selected and then press the [ENTER] key.**
  - This will restart the countdown and cause the timer function menu to disappear.

## To reset the timer to its start time

- 1. Press the [TIMER] key to display the timer function menu.**
- 2. Use the [▼] key to select “Reset Timer” and then press the [ENTER] key.**
  - This will return the timer to the start time specified by “Start Time” and cause the timer function menu to disappear.

# Eco Mode (Power Saving, Low Noise)

The following three Eco Mode settings are available to specify whether priority should be given to low-power, low-noise operation or to projection brightness.

- On (Auto)** : A brightness sensor on the top of the projector senses surrounding light, and automatically adjusts projection brightness and color accordingly. Brightness is reduced for darker surroundings, which saves power and reduces operation noise.
- On (Manual)**: Enables manual adjustment to balance the needs of low-power, quiet operation and projection brightness.
- Off** : Give top priority to projection brightness.



## Important!

- While “On (Auto)” is selected as the Eco Mode setting, make sure that the brightness sensor on the top of the projector is not blocked by anything.
- The local environment and setup conditions affect the brightness sensor, so operation when “On (Auto)” is selected for the Eco Mode depends on these factors.

## To select the Eco Mode

### 1. Press the [ECO] key.

- This causes “Eco Mode” window to appear on the projection screen.

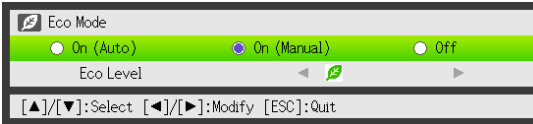

### 2. Use the [◀] and [▶] keys to select the setting you want.

- If you select “On (Manual)” here, go to step 3. If you select another setting, jump to step 4.

### 3. Perform the following steps to adjust the “Eco Level” (the balance between low-power, quiet operation and projection brightness).

- ① Press the [▼] key to move the highlighting to the Eco Level.
- ② Use the [◀] and [▶] keys to adjust the Eco Level to the setting you want.  
Fewer 🌿 marks gives higher priority to projection brightness. A greater number gives high priority to low-power, quiet operation.

### 4. To hide the window, press the [ESC] key.



## Important!

The “On (Auto)” setting cannot be selected for the Eco Mode while “Rear” is selected for “Screen Settings → Projection Mode” (page 37) on the setup menu. If the “Projection Mode” setting is changed to “Rear” while “On (Auto)” is selected for the Eco Mode setting, the Eco Mode setting will automatically change to “On (Manual)”.



## Note

- While “Off” is selected for the Eco Mode setting, you also can specify whether brightness or color should be given emphasis. For details, see “Eco Off Mode” (page 34) under “Image Adjustment 1 Main Menu”.
- **(for USB port model users)**  
Use the setup menu (page 25) to select the Eco Mode when the input source is an external device connected to the USB port or via the wireless adapter.

## Using the [FUNC] Key

Pressing the [FUNC] key displays the menu shown below.

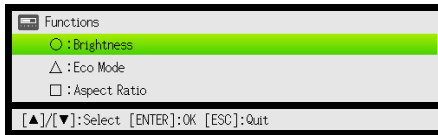

You can use this menu to perform the operations described below.

- **Adjust image brightness**

Highlight “Brightness” and then press the [ENTER] key.

→ This performs the same operation as pressing the [BRIGHT] key (○ key) described on page 15.

- **Turn the Eco Mode on or off**

Highlight “Eco Mode” and then press the [ENTER] key.

→ This performs the same operation as pressing the [ECO] key (△ key) described on page 23.

- **Select the aspect ratio of the projected image**

Highlight “Aspect Ratio” and then press the [ENTER] key.

→ This performs the same operation as pressing the [ASPECT] key (□ key) described on page 19.



## Note

### (for USB port model users)

When the input source is an external device connected to the USB port or via the wireless adapter, use the [FUNC], [○], [△], and [□] keys to control the connected device. For details, see the “USB Function Guide” and “Wireless Function Guide” on the bundled CD-ROM.



# Configuring Advanced Projector Settings

Your projector has a setup menu that you can use to configure advanced settings.

## Basic Setup Menu Operations

### Displaying the Setup Menu

Pressing the [MENU] key displays the menu shown below in the center of the projection screen.

**Main menu**  
Pressing the [MENU] key displays the main menu. The currently selected menu item is the one that is highlighted.

**Sub-menu**  
The sub-menu shows each individual setting under each main menu item, and its current setting.

**Guidance text**  
Guidance text provides a brief description of the main key operations available for the operation you are currently performing.

### To exit the setup menu

Press the [MENU] key.

## Configuring Setup Menu Settings

1. Press the [MENU] key to display the setup menu.
2. Use the [▼] and [▲] keys to select the main menu item you want by highlighting it.
3. Press the [ENTER] key.
4. Use the [▼] and [▲] keys to select the sub-menu item you want by highlighting it.
5. Perform the required operation on the selected sub-menu item screen.
  - The guidance text explains the operations you need to perform to configure each setting.
6. To return to the main menu from the sub-menu, press the [ESC] key.
7. To exit the setup menu, press the [MENU] key.

# Basic Setup Menu Example

The procedure below shows how to configure the following three settings:

- Image Adjustment 1 → Contrast
- Image Adjustment 1 → Color Mode
- Input Settings → Signal Name Indicator



## Note

- The setup menu items that you can change depend on whether or not an image signal is being input to the projector, and on the currently selected input source. Perform the procedure below after starting projection of an image from an input source.
- This example covers basic steps only. For more detailed information, see “Setup Menu Contents” on page 33.

## To configure the “Image Adjustment 1 → Contrast” setting

1. Press the [MENU] key to display the setup menu.
2. “Image Adjustment 1” is initially selected on the main menu, so simply press the [ENTER] key.
3. Use the [▼] key to select “Contrast”.

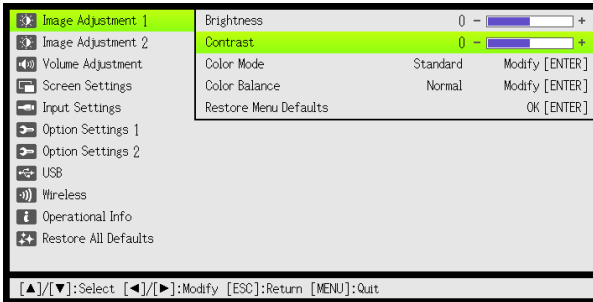

4. Use the [◀] (lighter) and [▶] (darker) keys to adjust contrast.

## To configure the “Image Adjustment 1 → Color Mode” setting

5. Use the [▼] key to select “Color Mode”.
6. Press the [ENTER] key.
  - This displays the color mode menu.
7. Use the [▼] and [▲] keys to select the color mode you want, and then press the [ENTER] key.
8. After selecting the color mode you want, press the [ESC] key.

## To configure the “Input Settings → Signal Name Indicator” setting

9. Press the [ESC] key.
10. Use the [▼] key to select “Input Settings”.
11. Press the [ENTER] key.
12. Use the [▼] key to select “Signal Name Indicator”.
13. Use the [◀] and [▶] keys to select “On” or “Off”.
14. After you are finished, press the [MENU] key to exit the setup menu.

## Direct Power On

You can configure the projector so it powers up automatically as soon as you plug it into a power source. With this “Direct Power On” feature, you do not even need to press the [⏻] (Power) key. To enable Direct Power On, display the setup menu, and then change the “Direct Power On” setting to “On”.



### Important!

---

When you have Direct Power On enabled, do not leave the projector plugged into an electrical outlet while it is turned off. If you do, there is the chance that it (and the light source unit) might turn on automatically when power is restored after being cut off by a power outage, tripping of a breaker, etc.



### Note

---

- Direct Power On causes the projector to turn on automatically as soon as it is plugged into a power outlet. This greatly reduces the amount of time it takes until you are ready to start projecting. Note, however, that the actual startup sequence (Standby State → Power On → Projection Starts) that the projector performs is the same, regardless of whether Direct Power On is enabled or disabled. The only difference is what triggers the sequence (plugging in or pressing the [⏻] (Power) key).
- For details about configuring the Direct Power On setting, see “Direct Power On” (page 39) under “Option Settings 1 Main Menu”.

# Password Protecting the Projector

The password feature lets you keep unauthorized individuals from using the projector. You can specify whether password input is required whenever you turn on the projector, and you can specify and change the password as required. Use the setup menu "Option Settings 1 → Power On Password" setting to configure power on password settings.

## Inputting a Password

The password of your projector is not really a "word" made up of letters, but rather a sequence of remote controller key inputs. The following is the 8-key sequence that represents the initial factory default password.

[INPUT] [AUTO] [BLANK] [FREEZE] [▲] [▼] [◀] [▶]

## Using the Password Feature

Note the following precautions whenever you use the password feature.

- The password feature protects against unauthorized use of the projector. Note that it is not an anti-theft measure.
- You will need to enter the initial factory default password the first time you use the projector after turning on the password feature. Change the initial factory default password to a different one of your choice as soon as possible after turning on the password feature.
- Remember that password operations are always performed using the remote controller, so you should take care not to lose or misplace the remote controller.
- Also note that you will not be able to input the password if the remote controller batteries are dead. Replace the remote control batteries as soon as possible after it starts to go low.

## If you forget your password...

You will not be able to use the projector if you forget the password for some reason. If you forget the password, you will need to bring the following two items to your CASIO distributor to have the password cleared. Note that you will be charged to have the password cleared.

1. Personal identification (original or copy of your driver's license, employee I.D., etc.)
2. Projector unit

Note that your CASIO distributor will not be able to clear the password of your projector unless you bring both of the items listed above.

Also, keep the projector's warranty in a safe place.



### Important!

Having your password cleared using the procedure described above will return all of the settings of your projector, except for the Light Time, to their initial factory defaults.

## Keep a written record of your password!

You will not be able to use the projector if you forget its password. We strongly suggest that you keep a written or other type of record of the password so you can look it up when necessary.

### To change the password

1. Press the [MENU] key to display the setup menu.
2. Use the [▼] key to select “Option Settings 1”, and then press the [ENTER] key.
3. Use the [▼] key to select “Power On Password”, and then press the [ENTER] key.

- This will display a dialog box prompting you to enter the current password.

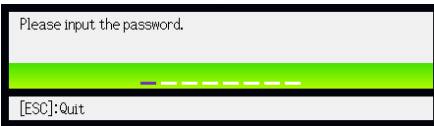

4. Enter the current password.

- If the projector is still protected by the factory default password, perform the key operation shown below to enter it.

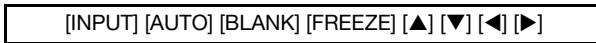

5. After entering the current password, press the [ENTER] key.

- This displays the Power On Password setting screen.

6. Use the [▼] key to select “Change Password”, and then press the [ENTER] key.

- This will display a dialog box prompting you to enter the new password.

7. Enter a key sequence up to eight key operations long.

- You can use any of the following keys as part of your password key sequence.  
[INPUT], [AUTO], [BLANK], [FREEZE], [VOLUME], [COLOR MODE], [D-ZOOM +], [D-ZOOM -], [KEYSTONE +], [KEYSTONE -], [MENU], [POINTER], [○], [△], [□], [▲], [▼], [◀], [▶], [FUNC]

8. After entering the new password, press the [ENTER] key.

- This will display a dialog box prompting you to enter the same password again.

9. Re-enter the same password key sequence you entered in step 7 and then press the [ENTER] key.

- The message “Your new password has been registered.” indicates that the password has been changed. Press the [ESC] key.
- If the password you entered in this step is different from the one you entered in step 7, the message “The password you input is wrong.” appears. Press the [ESC] key to return to step 7.

## To turn password protection on and off

1. Display the Power On Password setting screen by performing steps 1 through 5 of the procedure under “To change the password” on page 29.
  - At this time, make sure that “Power On Password” is selected on the Power On Password setting screen.
2. Use the [◀] and [▶] keys to select “On” or “Off”.
  - Changing the power on password setting from “Off” to “On” causes the confirmation dialog box shown below to appear.

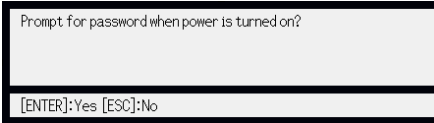

Press the [ENTER] key to confirm that you want to turn on power on password protection, or [ESC] to exit the dialog box without doing anything.

3. After you are finished, press the [MENU] key to exit the setup menu.

## Entering the Password when Turning On the Projector

When you turn on the projector while password protection is turned on will cause a password input dialog box to appear on the projection screen. All projector operations will be accessible to you after you input the correct password and press the [ENTER] key.



### Note

You can perform the projection size adjustment operation ([ZOOM +] / [ZOOM -] keys), focus operation ([FOCUS ▲] / [FOCUS ▼] keys), and power off operation ([⏻] (Power) key) while the password input dialog box is on the projection screen.

# Restoring Projector Settings to Their Initial Factory Defaults

You can use the procedures in this section to restore all of the settings on a particular main menu or all of the settings on the setup menu to their initial factory defaults.

## To restore all settings on a particular main menu to their initial factory defaults

1. Press the [MENU] key to display the setup menu.
2. Use the [▼] and [▲] keys to select the main menu whose settings you want to restore to their initial factory defaults.
  - You can select Image Adjustment 1, Image Adjustment 2, Volume Adjustment, Screen Settings, Input Settings, Option Settings 1, or Option Settings 2.
3. Press the [ENTER] key.
4. Use the [▼] key to select “Restore Menu Defaults”.
5. Press the [ENTER] key.
  - This will display a confirmation screen like the screen shown below.

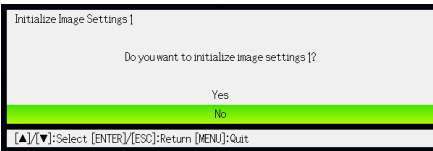

6. Use the [▲] key to select “Yes”.
7. To restore the settings of the main menu to their initial defaults, press the [ENTER] key.
  - To exit the operation without doing anything, press [ESC] instead of [ENTER].
8. After you are finished, press the [MENU] key to exit the setup menu.



### Note

- The language setting and the password are not returned to their initial factory defaults if you select Option Settings 1 in step 2.
- For details about how the above procedure initializes settings, see the explanations of the settings under “Setup Menu Contents” on page 33.

## To restore all settings on the setup menu to their initial factory defaults

- 1. Press the [MENU] key to display the setup menu.**
- 2. Use the [▼] key to select “Restore All Defaults” and then press the [ENTER] key.**
- 3. After confirming that “Restore All Defaults” sub-menu is selected, press the [ENTER] key.**
  - This displays a confirmation message asking if you want to initialize all settings.
- 4. Use the [▲] key to select “Yes”.**
- 5. To restore all settings on the setup menu to their initial defaults, press the [ENTER] key.**
  - This will restore all of the settings to their initial factory defaults, except for the Language, Light Time, Unit Operating Time and password settings.
  - To exit the operation without doing anything, press [ESC] instead of [ENTER].
- 6. After you are finished, press the [MENU] key to exit the setup menu.**



# Setup Menu Contents

This section contains tables that provide detailed explanations of all of the items included on the setup menu. The following describes the type of information that appears in each of the columns of the tables.

**Setting Name:** This column shows the names of the settings as they appear on the sub-menu.

**Input:** This column shows the input source for which each setting is supported.

Input source names are abbreviated as follows:

- R : RGB input
- C : component video input
- V : video input
- H : HDMI (PC) input
- D : HDMI (DTV) input
- W : Wireless LAN input (USB port models only)
- U : USB input (USB port models only)

The letter N indicates that the setting can be configured while there is no input signal.

**Setting Unit:** The setting unit indicates how a setting is stored.

“Source Specific” in this column indicates that separate settings can be stored for each individual input source.

“Single” in this column indicates that a single setting is stored and applied, regardless of the input source.

**Description:** This column provides details about the setting item and how to select it. The initial default setting is indicated by an asterisk (\*).

## Image Adjustment 1 Main Menu

| Setting Name | Input         | Setting Unit                  | Description  |
|--------------|---------------|-------------------------------|--|
| Brightness   | R C V H D W U | Source Specific* <sup>1</sup> | Use this sub-menu to adjust the brightness of the projected image. A larger value produces a brighter image.   |
| Contrast     | R C V H D W U | Source Specific* <sup>1</sup> | Use this sub-menu to adjust the contrast of the projected image. A larger value produces a stronger contrast.  |
| Sharpness    | V             | Source Specific               | Use this sub-menu to adjust the sharpness of the outlines in the projected image. A larger value makes the image sharper, while a smaller value makes it softer.   |
| Saturation   | V             | Source Specific               | Use this sub-menu to adjust the color saturation of the projected image. A larger value increases color saturation.  |
| Tint         | V             | Source Specific               | Use this sub-menu to adjust the tint of the projected image. A larger value makes the overall image more bluish, while a smaller value makes the overall image more reddish. This setting is supported only when the signal is NTSC or NTSC4.43. |

| Setting Name          | Input         | Setting Unit      | Description  |
|-----------------------|---------------|-------------------|--|
| Color Mode            | R C V H D W U | Source Specific*1 | <p>You can select from among various different color mode settings in accordance with image contents and projection conditions.</p> <p><b>Standard:</b><br/>Use this setting when you want to highlight the colors of your presentation.</p> <p><b>Graphics:</b><br/>Use this setting when you want photographs and graphics to appear natural.</p> <p><b>Theater:</b><br/>Use this setting to bring out the dark portions of your images.</p> <p><b>Blackboard:</b><br/>Use this setting for easy viewing when projecting onto a blackboard.</p> <p><b>Game:</b><br/>Use this setting to optimize hue and brightness.</p> |
| Color Balance         | R C V H D W U | Source Specific*1 | <p>This sub-menu lets you adjust the color balance of the projected image.</p> <p><b>Preset:</b><br/>You can select from among three preset color balance settings: Warm, Normal,* Cold.</p> <p><b>Color:</b><br/>You can adjust the intensity of red, green, and blue within the range of -50 to +50. The intensity of a color increases along with the setting value. Color settings can be adjusted individually only when "Normal" is selected as the "Preset" setting.</p>  |
| Eco Off Mode          | R C V H D W U | Single            | <p>When "Off" is selected for "Option Settings 1 → Eco Mode", you can select either of the following projection image modes.</p> <p><b>Bright:</b><br/>Gives priority to brightness.</p> <p><b>Normal:</b><br/>Suppresses brightness slightly and gives priority to color balance.</p>   |
| Restore Menu Defaults | R C V H D W U | Source Specific*1 | <p>Use this sub-menu to return all of the sub-menu items on the Image Adjustment 1 main menu to their initial default settings.</p> <ul style="list-style-type: none"> <li>Restoring menu defaults when there is no input signal will restore defaults for the currently selected input source.</li> </ul>   |

\*1 The same setting value is saved for both wireless LAN input (W) and USB input (U).

## Image Adjustment 2 Main Menu

| Setting Name          | Input | Setting Unit    | Description  |
|-----------------------|-------|-----------------|--|
| Vertical Position     | R C V | Signal Specific | Use this sub-menu to adjust the vertical position of the input source image within the projection area.  |
| Horizontal Position   | R C V | Signal Specific | Use this sub-menu to adjust the horizontal position of the input source image within the projection area.  |
| Frequency             | R     | Signal Specific | When vertical bands appear in the projected image while RGB is selected as the input source, it means that the frequency setting is not correct. When this happens, use this setting to adjust the frequency manually.<br><br> <b>Important!</b> _____<br>If, for some reason, your manual frequency settings cause the image input from the computer to disappear from the projection, you can press the [AUTO] key to perform an auto adjust operation, which should cause the image to appear. |
| Phase                 | R     | Signal Specific | When there is flickering in the projected image while RGB is selected as the input source, it means that the phase setting is not correct. When this happens, use this setting to adjust the phase manually.   |
| Restore Menu Defaults | R C V | Source Specific | Use this sub-menu to return all of the sub-menu items on the Image Adjustment 2 main menu to their initial default settings. <ul style="list-style-type: none"> <li>● Restoring menu defaults will restore defaults for the current signal type (XGA/60Hz, SXGA/60Hz, etc.) only.</li> </ul>   |

### About the “Signal Specific” Setting Unit



For the items that have “Signal Specific” in the “Setting Unit” column of the above table, the setting is saved for the specific type of signal (XGA/60Hz, SXGA/60Hz, etc.) that is being input when the setting is performed, and not for a specific input source.

## Volume Adjustment Main Menu

| Setting Name          | Input           | Setting Unit      | Description   |
|-----------------------|-----------------|-------------------|---|
| Volume                | R C V H D W U N | Source Specific*1 | Use this sub-menu to adjust the volume level of the projector’s speaker or the AV terminal. <ul style="list-style-type: none"> <li>● Changing this setting when there is no input signal changes the volume setting of the currently selected signal source.</li> </ul> |
| Restore Menu Defaults | R C V H D W U N | Source Specific*1 | Use this sub-menu to return Volume to its initial default setting. <ul style="list-style-type: none"> <li>● Restoring menu defaults when there is no input signal will restore defaults for the currently selected input source.</li> </ul>                             |

\*1 The same setting value is saved for both wireless LAN input (W) and USB input (U).

# Screen Settings Main Menu

| Setting Name        | Input           | Setting Unit    | Description   |
|---------------------|-----------------|-----------------|---|
| Keystone Correction | R C V H D W U N | Single          | Use this sub-menu to perform vertical keystone correction of the projected image.   |
| Aspect Ratio        | R C V H D       | Source Specific | <p>Use this sub-menu to select an aspect ratio setting for the projected image.</p> <p><b>Input Source: RGB or HDMI (PC)</b></p> <p><b>Normal*:</b><br/>Projects at the projector's maximum possible size while maintaining the input signal aspect ratio.</p> <p><b>Full:</b><br/>Projects at the projector's maximum possible size by enlarging or reducing the input signal.</p> <p><b>4:3 (XJ-A241/XJ-A246/XJ-A251/XJ-A256 only):</b><br/>Regardless of the input signal aspect ratio, the image is always resized to an aspect ratio of 4:3 for projection.</p> <p><b>True (XJ-A241/XJ-A246/XJ-A251/XJ-A256 only):</b><br/>Projects the input signal at its actual size (1 input source dot equal to one projector output pixel dot) in the center of the projector's projection screen. If the input signal resolution exceeds the projector's output resolution, the excess is cut off.</p> <p><b>Input Source: Video, Component or HDMI (DTV)</b></p> <p><b>Normal*:</b><br/>Projects at the projector's maximum possible size while maintaining the input signal aspect ratio.</p> <p><b>16:9 :</b><br/>This setting specifies a 16:9 aspect ratio, which is the same as a movie screen, high-definition TV, etc. Using this setting when the input signal is a 16:9 image that has been squeezed to a 4:3 image causes the image to be displayed with its normal 16:9 aspect ratio.</p> <p><b>4:3 (XJ-A241/XJ-A246/XJ-A251/XJ-A256 only):</b><br/>Regardless of the input signal aspect ratio, the image is always resized to an aspect ratio of 4:3 for projection.</p> <p><b>Letter Box (XJ-A241/XJ-A246/XJ-A251/XJ-A256 only):</b><br/>This will resize the image horizontally to 1280 dots and project 800 vertical dots of the center of the image, maintaining the aspect ratio of the input signal.</p> <p> <b>Note</b></p> <ul style="list-style-type: none"> <li>● When projecting while "True" is selected as the aspect ratio setting for an RGB signal with a resolution that is less than SVGA, the image is enlarged to SVGA and projected.</li> <li>● For details about projection screen display conditions for different aspect ratio settings, see "Aspect Ratio Setting and Projection Image" (page 51).</li> </ul> <p> <b>Important!</b></p> <p>Note that enlarging or reducing the size of an image for commercial purposes or public presentation may infringe on the legally protected copyright of the copyright holder of the original material.</p> |

| Setting Name          | Input           | Setting Unit    | Description   |
|-----------------------|-----------------|-----------------|---|
| Projection Mode       | R C V H D W U N | Single          | Use this sub-menu to specify whether projection will be from the front of the screen or the back of the screen.<br><b>Front*:</b><br>Select this option to project from the front of the screen.<br><b>Rear:</b><br>Select this option to project from the back of the screen. This setting flips the front projected image horizontally.   |
| Ceiling Mount         | R C V H D W U N | Single          | Use this sub-menu to configure the projector for use in an installation in which it is positioned upside down.<br><b>On:</b><br>Flips the projected image horizontally and vertically.<br><b>Off*:</b><br>Projects a normal image.  |
| Startup Screen        | R C V H D W U N | Single          | Use this sub-menu to specify whether or not a startup screen should be projected whenever the projector is turned on.<br><b>Logo:</b><br>Select this option to project the projector's built-in logo screen at startup.<br><b>None*:</b><br>Select this option when you do not want to project a startup screen.  |
| No Signal Screen      | R C V H D W U N | Single          | Use this sub-menu to specify what should be projected when there is no input signal to the projector.<br><b>Blue*:</b><br>Select this option to project a blue screen.<br><b>Black:</b><br>Select this option to project a black screen.<br><b>Logo:</b><br>Select this option to project the projector's built-in logo screen.   |
| Blank Screen          | R C V H D W U N | Single          | Use this sub-menu to specify what should be projected after the [BLANK] key is pressed.<br><b>Blue:</b><br>Select this option to project a blue screen.<br><b>Black*:</b><br>Select this option to project a black screen.<br><b>Logo:</b><br>Select this option to project the projector's built-in logo screen.   |
| Restore Menu Defaults | R C V H D W U N | Source Specific | Use this sub-menu to return all of the sub-menu items on the Screen Settings main menu to their initial default settings.<br><ul style="list-style-type: none"> <li>● Restoring menu defaults when there is no input signal will restore defaults for the currently selected input source.</li> <li>● Note that the "Keystone Correction", "Projection Mode", "Ceiling Mount", "Startup Screen", "No Signal Screen", and "Blank Screen" settings are always returned to their initial defaults, regardless of the currently selected input source.</li> </ul> |

# Input Settings Main Menu

| Setting Name          | Input           | Setting Unit    | Description  |
|-----------------------|-----------------|-----------------|--|
| COMPUTER Terminal     | R C N           | Single          | <p>Use this sub-menu to specify manually the type of signal being input from the projector's COMPUTER terminal.</p> <p><b>Auto*:</b><br/>Automatically detects the signal being input from the COMPUTER terminal and configures the appropriate input protocol.</p> <p><b>RGB:</b><br/>Select this option when a computer is connected to the COMPUTER terminal. For details about connecting a computer, see "Connecting the Analog RGB Output of a Computer to the Projector" (page 11).</p> <p><b>Component:</b><br/>Select this setting when the projector's COMPUTER terminal is connected to the component video output terminal of a video device using a commercially available component video cable. For information about connection, see "Connecting to a Video Device" (page 13).</p> |
| Video Signal          | V N             | Single          | <p>Use this sub-menu to specify manually the type of signal being input from the projector's AV terminal.</p> <p><b>Auto*:</b><br/>Select this setting to have the projector switch the video signal system automatically in accordance with the input signal from the video device that is connected to the AV terminal.</p> <p><b>NTSC / NTSC4.43 / PAL / PAL-M / PAL-N / PAL60 / SECAM:</b><br/>Each setting selects the applicable video system. Use these settings when you want to specify only one specific video signal for the AV terminal.</p>   |
| Signal Name Indicator | R C V H D W U N | Single          | <p>Use this sub-menu to specify whether or not the name of the currently selected signal source should be displayed in the projected image.</p> <p><b>On*:</b><br/>Select this option to turn on display of the name of the currently selected signal source in the projected image.</p> <p><b>Off:</b><br/>Select this option to turn off display of the signal source name.</p>  |
| Restore Menu Defaults | R C V H D W U N | Source Specific | <p>Use this sub-menu to return all of the sub-menu items on the Input Settings main menu to their initial default settings.</p> <ul style="list-style-type: none"> <li>● Restoring menu defaults when there is no input signal will restore defaults for the currently selected input source.</li> <li>● Note that the "Signal Name Indicator" setting is always returned to its initial default, regardless of the currently selected input source.</li> </ul>  |

## Option Settings 1 Main Menu

| Setting Name             | Input           | Setting Unit    | Description   |
|--------------------------|-----------------|-----------------|---|
| Auto Keystone Correction | R C V H D W U N | Single          | Use this sub-menu to turn auto keystone correction on or off.<br><b>On*:</b><br>Select this option to turn on auto keystone correction.<br><b>Off:</b><br>Select this option to turn off auto keystone correction.  |
| Auto Adjust              | R C V H D W U N | Source Specific | Use this sub-menu to select whether the projector should detect the RGB input signal type (resolution, frequency) and adjust the projection image accordingly (auto adjust).<br><b>1*:</b><br>Select this option to turn on auto adjust.<br><b>2:</b><br>Select this option to turn on auto adjust when a 1360 × 768 or 1400 × 1050 signal is not projected correctly.<br><b>3:</b><br>Select this option to turn on auto adjust when a 1366 × 768 signal is not projected correctly.<br><b>Off:</b><br>Select this option to turn off auto adjust. |
| Eco Mode                 | R C V H D W U N | Single          | See “Eco Mode (Power Saving, Low Noise)” (page 23).   |
| Auto Power Off           | R C V H D W U N | Single          | Auto Power Off lets you specify the amount of time of projector operation and input signal inactivity to be allowed before Auto Power Off is triggered to turn off projector power automatically. Auto Power Off can be disabled, if you want.<br><b>5 min, 10 min*, 15 min, 20 min, 30 min:</b><br>Time until Auto Power off is triggered.<br><b>Off:</b><br>Disables Auto Power Off.  |
| Power On Password        | R C V H D W U N | Single          | You can configure the projector to require input of a password before operation is enabled. For details, see “Password Protecting the Projector” on page 28.  |
| Direct Power On          | R C V H D W U N | Single          | Use this sub-menu to turn Direct Power On on or off. See “Direct Power On” on page 27.<br><b>On:</b><br>Select this option to turn on Direct Power On.<br><b>Off*:</b><br>Select this option to turn off Direct Power On.   |

| Setting Name          | Input           | Setting Unit | Description   |
|-----------------------|-----------------|--------------|---|
| Language              | R C V H D W U N | Single       | <p>Use this sub-menu to specify the language to use for messages, setup menus, etc.</p> <p>English / French / German / Italian / Spanish / Swedish / Portuguese / Turkish / Russian / Chinese (Simplified) / Chinese (Traditional) / Korean / Japanese</p> <p> <b>Note</b> _____<br/> <b>(for USB port model users)</b><br/>           If you have Portuguese, Turkish, or Russian selected as the projector's language, selecting an external device connected to the projector's USB port or wireless adapter as the input source will cause some menus and messages to be displayed in English.</p> |
| Restore Menu Defaults | R C V H D W U N | Single       | <p>This sub-menu returns all of the sub-menu items on the Option Settings 1 main menu to their initial default settings.</p> <ul style="list-style-type: none"> <li>● The language setting and the password are not returned to their initial factory defaults.</li> <li>● The "Auto Adjust" item is returned to its initial default only when RGB input is selected for the input source. All of the other items are returned to their initial defaults regardless of the currently selected input source.</li> </ul>  |

## Option Settings 2 Main Menu

| Setting Name | Input           | Setting Unit | Description  |
|--------------|-----------------|--------------|--|
| Zoom Memory  | R C V H D W U N | Single       | <p>This sub-menu specifies whether the current zoom setting (projection size) should be saved when the [⏻] (Power) key is pressed to turn the projector off. A saved projection size setting is restored the next time the projector is turned on.</p> <p><b>On*:</b><br/>           Select this option to automatically restore the projection size in effect the last time the projector was turned off by pressing the [⏻] (Power) key.</p> <p><b>Off:</b><br/>           Select this option to have the projector configured the maximum projection size whenever it is turned on.</p> <p> <b>Note</b> _____<br/>           The current zoom setting is not saved if projector power is turned off by unplugging the power cord without pressing the [⏻] (Power) key. If you want the current projection size to be saved and restored, be sure to press the [⏻] (Power) key to turn the projector off.</p> |
| Pointer      | R C V H D W U N | Single       | <p>Use this sub-menu to specify the type of pointer that appears first when you press the [POINTER] key.</p>   |



| Setting Name                            | Input           | Setting Unit | Description   |
|---|-----------------|--------------|---|
| Plug and Play<br>(USB port models only) | R C V H D W U N | Single       | Use this sub-menu to turn plug-and-play*1 on or off.<br><b>On*:</b><br>Select this option to turn on plug-and-play. This will allow the projector detect when an external USB device is connected and make that device the input source automatically.<br><b>Off:</b><br>Select this option to turn off plug-and-play.  |
| USB Audio Out<br>(USB port models only) | R C V H D W U N | Single       | When playing back a movie file stored on a USB memory device, you can select audio output from the projector's built-in speaker or to the line output.<br><b>Speaker*:</b><br>Select to output movie file audio from the speaker.<br><b>Line:</b><br>Select to output movie file audio from the AV terminal.  |
| HDMI Audio Out                          | R C V H D W U N | Single       | Specifies whether the input audio signal should be output from the projector's built-in speaker or to the line output.<br><b>Speaker*:</b><br>Outputs the audio signal being input to the HDMI port from the speaker.<br><b>Line:</b><br>Outputs the audio signal being input to the HDMI port from the AV terminal.  |
| High Altitude                           | R C V H D W U N | Single       | Use this sub-menu to turn the high-altitude fan speed setting on or off in accordance with the altitude of the area where you are using the projector.<br><b>On:</b><br>Select this setting when using the projector in a high altitude (1,500 to 3,000 meters above sea level) area where air is thin. This setting increases cooling efficiency.<br><b>Off*:</b><br>Select this setting at normal altitudes (up to 1,500 meters).<br> <b>Important!</b> _____<br>Do not use this projector at altitudes greater than 3,000 meters above sea level. |
| Timer Function                          | R C V H D W U N | Single       | Selecting this item displays the timer function menu. For details, see "Presentation Timer" (page 21).  |
| Restore Menu Defaults                   | R C V H D W U N | Single       | This sub-menu returns all of the sub-menu items on the Option Settings 2 main menu to their initial default settings.   |

\*1 When plug-and-play is turned on, the projector will make that device the input source automatically. For details about plug-and-play, see "USB Function Guide" on the bundled CD-ROM.

## USB Settings Main Menu (USB Port Models Only)

The USB Settings main menu is available only when there is an external device connected to the USB port of the projector. For details, see “USB Function Guide” on the bundled CD-ROM.

## Wireless Main Menu (USB Port Models Only)

The Wireless main menu is available only when “Wireless” is selected as the input source on the projector. For more information, see the “Wireless Function Guide” on the CD-ROM that comes with the projector.

## Operational Info Main Menu

| Setting Name         | Input           | Setting Unit    | Description  |
|----------------------|-----------------|-----------------|--|
| Input Signal         | R C V H D W U N | Source Specific | This sub-menu item shows the currently selected input signal (RGB, Component, Video, HDMI (PC), or HDMI (DTV)). “- - -” is indicated here when there is no input signal.   |
| Signal Name          | R C V H D U     | Source Specific | This sub-menu item shows the signal name of the signal being input to the projector. For details about signal names, see “Signal Name” under “Supported Signals” (page 53).  |
| Resolution           | R H             | Source Specific | This sub-menu item appears only when RGB is the input signal. It shows the number of vertical and horizontal pixels of resolution of the RGB or HDMI (PC) input signal.  |
| Horizontal Frequency | R C V H D       | Source Specific | This sub-menu item shows the horizontal frequency of the input signal.   |
| Vertical Frequency   | R C V H D       | Source Specific | This sub-menu item shows the vertical frequency of the input signal.   |
| Scan System          | R C H D         | Source Specific | This sub-menu item appears only when RGB, Component, HDMI (PC), or HDMI (DTV) is the input signal, and shows the scan system of the input signal. The scan system is interlace or non-interlace for an RGB or HDMI (PC) signal input, and interlace or progressive for a component or HDMI (DTV) signal input. |
| Light Time           | R C V H D W U N | Single          | This sub-menu item shows the cumulative number of hours the current light source unit has been used to date.   |

## Restore All Defaults Main Menu

| Setting Name         | Input           | Setting Unit | Description   |
|----------------------|-----------------|--------------|---|
| Unit Operating Time  | R C V H D W U N | Single       | This sub-menu item shows the cumulative operating time of this unit. This time cannot be initialized.   |
| Restore All Defaults | R C V H D W U N | Single       | This sub-menu returns all sub-menu items on all main menus to their initial default settings. This operation can be performed regardless of the currently selected input source and regardless of whether or not a signal is currently being input. For details about this procedure, see “To restore all settings on the setup menu to their initial factory defaults” on page 32. |

# Cleaning the Projector

Periodically clean the projector exterior, lens, intake vents, and exhaust vents on a regular basis.



## Important!

Before cleaning the projector, be sure to unplug it from the power outlet and make sure it is cooled down completely.

## Cleaning the Projector Exterior

Wipe the exterior of the projector with a soft cloth that has been moistened in a weak solution of water and a mild neutral detergent. Be sure to wring all excess moisture from the cloth before wiping. Never use benzene, alcohol, thinner, or any other volatile agent for cleaning.

## Cleaning the Lens

Carefully wipe the lens with a commercially available lens cloth or optical lens paper, like those for eyeglasses or camera lenses. When cleaning the lens, do not apply undue force and take care to avoid damaging the lens.

## Cleaning Intake and Exhaust Vents

Dust and dirt tend to collect around the intake vents. Because of this, you should use a vacuum cleaner to clean away accumulated dust and dirt periodically as shown below.

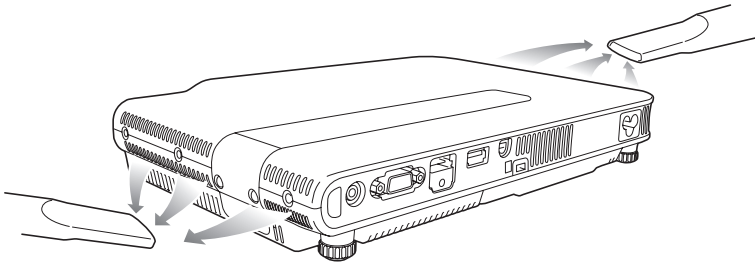

## Important!

- Continued use of the projector after dust has accumulated around the intake vents can cause overheating of internal components and lead to malfunction.
- Certain operating conditions also can cause dirt and dust to accumulate around the projector's exhaust vents. If this happens, use the same procedure as that described above to clean the exhaust vents.

# Troubleshooting

## Indicators

Indicators keep you informed about the current operational status of the projector. The following shows what the indicators look like when operation is normal.

| When the indicators appear like this: |                     |                    | It means this:   |
|---------------------------------------|---------------------|--------------------|--|
| POWER/<br>STANDBY<br>●<br>Amber       | LIGHT<br>●<br>Amber | TEMP<br>●<br>Amber | You have just plugged the AC power cord into a power outlet. Wait until the projector enters the standby state (see below) before trying to turn on power. |
| ●<br>Amber                            | ○                   | ○                  | Standby state: The AC power cord is plugged in and the projector is in standby.  |
| ◎<br>Green                            | ●<br>Amber          | ●<br>Amber         | Projector is warming up after being turned on.   |
| ●<br>Green                            | ○                   | ○                  | Projector is on and standing by for use.   |
| ◎<br>Amber                            | ○                   | ○                  | Projector is performing internal power down processes.   |
| ●<br>Green                            | ●<br>Green          | ○                  | “On (Auto)” or “On (Manual)” is selected for the projector’s Eco Mode (page 23) setting.   |

● : Lit      ◎ : Flashing      ○ : Unlit

When a warning message appears on the projection screen, or when the POWER/STANDBY, LIGHT, and TEMP indicators are lit or flashing in a pattern other than those shown above, it means that a projector error has occurred. For details, see “Error Indicators and Warning Messages” (below).

## Error Indicators and Warning Messages

Warning messages and indicators let you know what the problem is when a projector error occurs.

When an error occurs, wait until the fan stops before unplugging the AC power cord. If you unplug the AC power cord while the fan is still operating, an error may occur when you plug the AC power cord back in.

| Indicator/Error Message  | Description and Required Action   |
|--|---|
| POWER : Green steady<br>LIGHT : –<br>TEMP : –<br>Message : Internal temperature is too high. Check projector air vents for blockage. | The projector’s internal temperature is very high. Press the [ESC] key to clear the warning message and perform the following steps.<br>① Check for any blocking of the projector’s intake vents and exhaust vents, and make sure that there is sufficient space around the projector. See “Setup Precautions” (page 10).<br>② If there is dust accumulated around the intake vents and/or exhaust vents, turn off the projector and remove it. See “Cleaning the Projector” (page 43). |

| Indicator/Error Message  | Description and Required Action   |
|--|---|
| <p>POWER : Amber flashing →<br/>Amber steady</p> <p>LIGHT : –</p> <p>TEMP : –</p> <p>Message : Internal temperature is too high. The projector will turn off.</p>                | <p>Power has turned off automatically due to internal overheating. Perform the following steps.</p> <p>① Check for any blocking of the projector's intake vents and exhaust vents, and make sure that there is sufficient space around the projector. See "Setup Precautions" (page 10).</p> <p>② If there is dust accumulated around the intake vents and/or exhaust vents, remove it. See "Cleaning the Projector" (page 43).</p> <p>If there is no problem with the projector's vents, confirm that the POWER/STANDBY indicator is lit amber (without flashing), and then turn power back on again. If the error occurs again when you turn power back on, contact your retailer or nearest authorized CASIO Service Center.</p>   |
| <p>POWER : Amber flashing →<br/>Red steady</p> <p>LIGHT : –</p> <p>TEMP : Red flashing<br/>(0.5-second interval)</p> <p>Message : –</p>  | <p>Power has turned off automatically due to internal overheating. This causes a dialog box containing the text in the next item below to appear the next time you turn on the projector. Follow the steps that are provided.</p>   |
| <p>POWER : Green steady</p> <p>LIGHT : –</p> <p>TEMP : –</p> <p>Message : The projector has a history of turning off due to high temperature. Check air vents for blockage.</p>  | <p>The last time you were using the projector, power turned off automatically due to internal overheating. Press the [ESC] key to clear the warning message and perform the following steps.</p> <p>① Check for any blocking of the projector's intake vents and exhaust vents, and make sure that there is sufficient space around the projector. See "Setup Precautions" (page 10).</p> <p>② If there is dust accumulated around the intake vents and/or exhaust vents, turn off the projector and remove it. See "Cleaning the Projector" (page 43).</p> <p>③ Disconnect the power cord from the projector and wait for all of the projector's indicators to go out. Next, reconnect the power cord and turn the projector back on. If the error occurs again when you turn power back on, contact your retailer or nearest authorized CASIO Service Center.</p> |
| <p>POWER : Amber flashing →<br/>Red steady</p> <p>LIGHT : Red steady</p> <p>TEMP : Red steady</p> <p>Message : There is a problem with the fan. The projector will turn off.</p> | <p>Power has turned off automatically due to a fan problem. Confirm that the POWER/STANDBY indicator is lit red (without flashing) and that the fan has stopped. After checking the POWER/STANDBY indicator, disconnect the power cord from the projector and wait for all of the projector's indicators to go out. Next, reconnect the power cord and turn projector power back on.</p> <p>If the error occurs again when you turn power back on, contact your retailer or nearest authorized CASIO Service Center.</p>  |
| <p>POWER : Amber flashing →<br/>Red steady</p> <p>LIGHT : –</p> <p>TEMP : Red steady</p> <p>Message : A system problem has occurred. The projector will turn off.</p>            | <p>Power has turned off automatically due to a system problem. After confirming that the POWER/STANDBY indicator is lit red (without flashing), disconnect the power cord from the projector and wait for all of the projector's indicators to go out. Next, reconnect the power cord and turn the projector back on.</p> <p>If the error occurs again when you turn power back on, contact your retailer or nearest authorized CASIO Service Center.</p>   |

| Indicator/Error Message   | Description and Required Action   |
|---|---|
| POWER : Green steady<br>LIGHT : –<br>TEMP : –<br>Message : A system problem has occurred. Normal projection is not possible.  | A system problem has occurred, which may cause problems with some functions. Turn off the projector, disconnect the power cord from the projector and wait for all of the projector's indicators to go out. Next, reconnect the power cord and turn the projector back on.<br>If the error occurs again when you turn power back on, contact your retailer or nearest authorized CASIO Service Center.<br>Press the [ESC] key to clear the warning message.   |
| POWER : Green steady<br>LIGHT : –<br>TEMP : –<br>Message : There is some problem with the system.<br>The audio function may not operate correctly.  |   |
| POWER : Green steady<br>LIGHT : –<br>TEMP : –<br>Message : There is a problem with the USB port.  | The USB connection was terminated because of a problem with the USB port. To use the USB function, turn off the projector and then turn it back on again.<br>If the error occurs again when you turn power back on, contact your retailer or nearest authorized CASIO Service Center.<br>Press the [ESC] key to clear the warning message.  |
| POWER : Green steady<br>LIGHT : –<br>TEMP : –<br>Message : Zoom and focus cannot be performed for some reason. Try turning the projector off and then back on again.<br>If this message reappears, request servicing. | Zoom and focus cannot be performed due to some trouble in the optical drive circuit. Turn off the projector and then turn it back on again.<br>If the error occurs again when you turn power back on, contact your retailer or nearest authorized CASIO Service Center.<br>Press the [ESC] key to clear the warning message.  |
| POWER : Amber flashing →<br>Red steady<br>LIGHT : –<br>TEMP : Red steady<br>Message : –   | The projector was turned off automatically due to some problem that was probably caused by external digital noise or some other reason. Confirm that the POWER/STANDBY indicator is lit red (without flashing). After checking the POWER/STANDBY indicator, disconnect the power cord from the projector and wait for all of the projector's indicators to go out. Next, reconnect the power cord and turn projector power back on.<br>If the error occurs again when you turn power back on, contact your retailer or nearest authorized CASIO Service Center. |
| POWER : Amber flashing →<br>Red steady<br>LIGHT : Red flashing<br>(0.5-second interval)<br>TEMP : Red flashing<br>(0.5-second interval)<br>Message : –  | The projector was turned off automatically because the light source unit turned off or did not turn on. After confirming that the POWER/STANDBY indicator is lit red (without flashing), unplug the power cord. Wait for a short while and then plug it back in and turn on the projector again.<br>If the error occurs again when you turn power back on, contact your retailer or nearest authorized CASIO Service Center.  |

| Indicator/Error Message  | Description and Required Action  |
|--|--|
| POWER : Amber flashing →<br>Red steady<br>LIGHT : Not lit or red flashing<br>TEMP : Red flashing<br>(2-second interval)<br>Message : – | Power has turned off automatically due to a projector memory error. Confirm that the POWER/STANDBY indicator is lit red (without flashing). After checking the POWER/STANDBY indicator, disconnect the power cord from the projector and wait for all of the projector's indicators to go out. Next, reconnect the power cord and turn projector power back on. If the error occurs again when you turn power back on, contact your retailer or nearest authorized CASIO Service Center.                             |
| POWER : Amber flashing →<br>Red steady<br>LIGHT : –<br>TEMP : Amber flashing<br>(1-second interval)<br>Message : –                     | Power has turned off automatically because the light source unit cover is open. Perform the following steps.<br>① After confirming that the POWER/STANDBY indicator is lit red (without flashing), disconnect the power cord from the projector.<br>② Check to make sure that the light source unit cover is closed.<br>③ Plug the power cord back in and turn the projector back on again. If the error occurs again when you turn power back on, contact your retailer or nearest authorized CASIO Service Center. |

## Projector Troubleshooting

Check the following items whenever you experience any problem with the projector.

| Problem   | Cause and Recommended Action  |
|---|---|
| Power does not turn on.   | <ul style="list-style-type: none"> <li>● If the POWER/STANDBY indicator is not lit, the AC power cord is not connected correctly. Connect the AC power cord correctly.</li> <li>● If the TEMP or LIGHT indicator remains flashing or lit, it means some type of error has occurred. See “Error Indicators and Warning Messages” (page 44).</li> </ul>   |
| No image is projected or the projected image is abnormal.                 | <ul style="list-style-type: none"> <li>● The computer or video device connected to the projector is not turned on or it is not outputting a video signal. Make sure the connected computer or video device is turned on, and perform the required operation on it to output a video signal.</li> <li>● The correct output source is not selected on the projector. On the projector, select the correct input source that corresponds to the connected device.</li> <li>● Images may not project correctly when you have the component output terminal of a video device connected to the COMPUTER terminal of the projector. Connect to the AV terminal of the projector.</li> </ul> |
| Image color or display is very abnormal.                                  | The wrong option (“Component” or “RGB”) may be selected for the “Input Settings → COMPUTER Terminal” setting on the setup menu. The image will not be projected correctly if “Component” is selected while the projector’s COMPUTER terminal is connected to the RGB output terminal of a computer, or if “RGB” is selected while the projector’s COMPUTER terminal is connected to the component video output terminal of a video device. On the setup menu, select “Auto” for the “Input Settings → COMPUTER Terminal” setting. See page 38.  |
| I can’t understand messages or menus because they are the wrong language. | <p>Perform the following operation to select the language you want. See page 40.</p> <ol style="list-style-type: none"> <li>1. Press the [MENU] key to display the setup menu.</li> <li>2. If the input signal is HDMI, press [▼] four times and then press the [ENTER] key. If the input signal is not HDMI, press [▼] five times and then press the [ENTER] key.</li> <li>3. Press [▲] twice and then press the [ENTER] key to display the language selection menu.</li> <li>4. Use the [▼] and [▲] keys to move the highlighting to the language you want to select and then press the [ENTER] key.</li> <li>5. Press the [MENU] key to exit the setup menu.</li> </ol>            |

| Problem   | Cause and Recommended Action   |
|---|--|
| No sound  | <ul style="list-style-type: none"> <li>● The projector's volume level setting may be too low or muted. Press the remote controller [VOLUME] key and then use [◀] and [▶] to adjust the volume level. See page 20.</li> <li>● The volume level setting of the device connected to the projector is too low or the other device is not outputting audio. Adjust the volume level of the connected device.</li> <li>● The audio output of the connected device may not be connected correctly to the projector's AV terminal. Check the connection, referring to one of the following (depending on the type of connected device): "Connecting the Analog RGB Output of a Computer to the Projector" (page 11) or "Connecting to a Video Device" (page 13).</li> <li>● When a video device's or computer's HDMI output is connected to the HDMI port of the projector, "Line" may be selected for the "Option Settings 2 → HDMI Audio Out" setting on the setup menu. Change the "HDMI Audio Out" setting to "Speaker". See page 41.</li> </ul> |
| Strange color   | <p>The input signal may not match projector settings. Try doing the following.</p> <ul style="list-style-type: none"> <li>– Use the [BRIGHT] key to adjust image brightness.</li> <li>– Use the [COLOR MODE] key to change the color mode.</li> <li>– On the setup menu, use "Image Adjustment 1 → Color Balance" to adjust the projection image color balance.</li> </ul>   |
| Text is blurry.   | <ul style="list-style-type: none"> <li>● The image may be out of focus. On the remote controller, use the [FOCUS ▲] and [FOCUS ▼] keys to adjust image focus.</li> <li>● The current frequency and/or phase setting do not match the input signal. (Applies only when the input source is an RGB signal.) Press the [AUTO] key to execute an automatic adjustment operation.</li> <li>● On the setup menu, perform the "Image Adjustment 2 → Frequency" and "Image Adjustment 2 → Phase" adjustments. (Applies only when the input source is an RGB signal.) See page 35.</li> <li>● If the input source is a video camera or document camera, check to make sure there is no problem with the input source device.</li> </ul>   |
| The message "Please input the password." appears and further operation is not possible. | <p>The "Option Settings 1 → Power On Password" setting on the setup menu is turned on, so the projector is password protected. Input the correct password, and then press the [ENTER] key. See page 28.</p>  |
| The remote controller does not work.  | <ul style="list-style-type: none"> <li>● The remote controller batteries may be dead. Replace the batteries.</li> <li>● The remote controller may be too far from the projector. Make sure the remote controller is within the allowable range when you operate it. See page 49.</li> </ul>  |
| The TEMP or LAMP indicator is flashing or lit.  | <p>An error occurred. See "Error Indicators and Warning Messages" (page 44).</p>   |
| The light source unit does not light.   | <p>The light source unit has reached the end of its service life or it is malfunctioning. Contact your original dealer or authorized CASIO service center for replacement.</p>   |



### Important!

- Try performing the following steps, which may or may not return the projector to normal operation.
  1. Unplug the AC power cord and wait for at least 10 minutes.
  2. Plug the power cord back in and turn the projector back on again.
- If normal operation does not resume after you perform the above steps, take the projector to your retailer or authorized CASIO service center.



## Remote Controller Signal Range

When performing an operation on the remote controller, point it at the remote control signal receiver on the back or front of the projector. The following illustration shows the range of the remote controller signal.

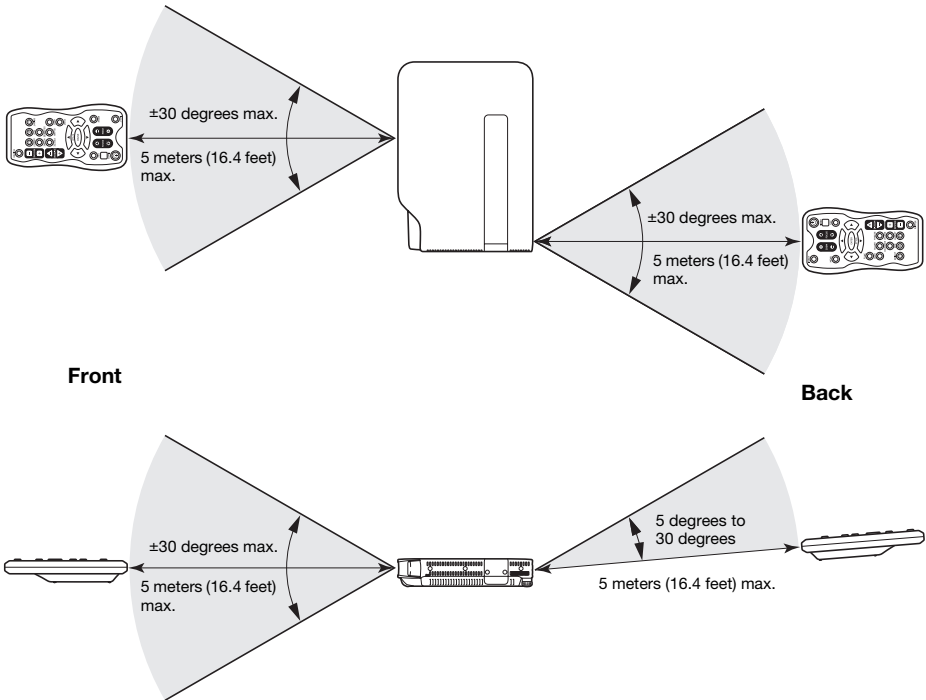

## Remote Controller Range

- The range of the remote controller may be narrower and/or shorter than that shown on the right (Back) when there is a special AV cable plugged into the AV terminal on the back of the projector.
- The allowable distance between the remote controller and the projector is less when there is a sharp angle between the remote controller and the remote control signal receiver.



### Important!

To avoid running down the batteries, store the remote control unit so its keys are not pressed inadvertently.

# Projection Distance and Screen Size

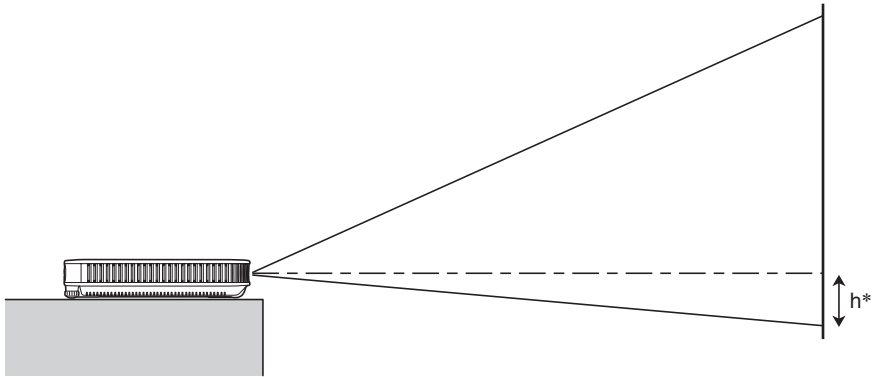

The following table shows the relationship between the distance and projected image size.

| Projection Size |               | Approximate Projection Distance |                             |       |                                 |                             |                   |
|-----------------|---------------|---------------------------------|-----------------------------|-------|---------------------------------|-----------------------------|-------------------|
|                 |               | XJ-A141/XJ-A146                 |                             |       | XJ-A241/XJ-A246/XJ-A251/XJ-A256 |                             |                   |
| Screen Size     | Diagonal (cm) | Minimum Distance (m / feet)     | Maximum Distance (m / feet) | $h^*$ | Minimum Distance (m / feet)     | Maximum Distance (m / feet) | $h^*$ (cm / inch) |
| 40              | 102           | 1.1 / 3.61                      | 2.2 / 7.22                  | 0     | 1.0 / 3.28                      | 1.9 / 6.23                  | 9 / 3.54          |
| 60              | 152           | 1.7 / 5.58                      | 3.4 / 11.15                 | 0     | 1.4 / 4.59                      | 2.8 / 9.19                  | 14 / 5.51         |
| 80              | 203           | 2.3 / 7.55                      | 4.5 / 14.76                 | 0     | 1.9 / 6.23                      | 3.8 / 12.47                 | 18 / 7.09         |
| 100             | 254           | 2.8 / 9.19                      | 5.6 / 18.37                 | 0     | 2.4 / 7.87                      | 4.8 / 15.75                 | 23 / 9.06         |
| 150             | 381           | 4.3 / 14.11                     | 8.5 / 27.89                 | 0     | 3.6 / 11.81                     | 7.2 / 23.62                 | 34 / 13.39        |
| 200             | 508           | 5.7 / 18.70                     | 11.3 / 37.07                | 0     | 4.8 / 15.75                     | 9.6 / 31.50                 | 45 / 17.72        |

\*  $h$  = Height from the center of the lens to the bottom edge of the projection screen.



## Important!

Note that the distances provided above are for reference only.

# Aspect Ratio Setting and Projection Image



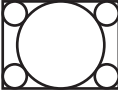
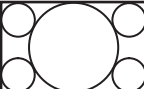
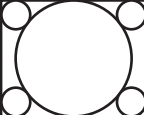

The following shows how images are projected in accordance with the type of the input signal and the aspect ratio setting of the projector.

## XJ-A241/XJ-A246/XJ-A251/XJ-A256

Input source: RGB or HDMI (PC)

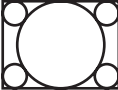

| Input Signal  | Normal | Full | 4:3 | True |
|---|--------|------|-----|------|
| <br>SVGA (800 × 600)   |        |      |     |      |
| <br>XGA (1024 × 768)   |        |      |     |      |
| <br>WXGA (1280 × 800)  |        |      |     |      |
| <br>SXGA (1280 × 1024) |        |      |     |      |

Input source: Video, component or HDMI (DTV)





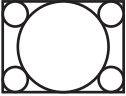
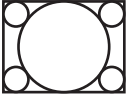
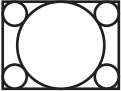
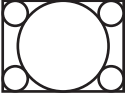
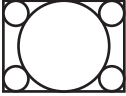
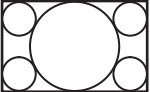

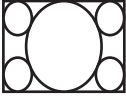
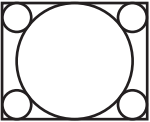
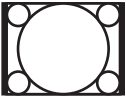
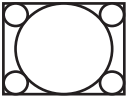
| Input Signal   | Normal | 16:9 | 4:3 | Letter Box |
|--|--------|------|-----|------------|
| <br>4:3 Aspect Image   |        |      |     |            |
| <br>Squeezed Image    |        |      |     |            |
| <br>Letter Box Image  |        |      |     |            |
| <br>16:9 Aspect Image |        |      |     |            |

# XJ-A141/XJ-A146

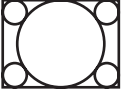
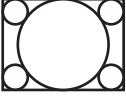
Input source: RGB or HDMI (PC)

| Input Signal  | Normal  | Full  |
|---|---|---|
|  <p>SVGA (800 × 600)</p>   |  |  |
|  <p>XGA (1024 × 768)</p>   |  |  |
|  <p>WXGA (1280 × 800)</p>  |  |  |
|  <p>SXGA (1280 × 1024)</p> |  |  |

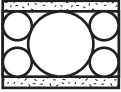
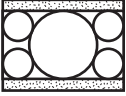
Input source: Video, component or HDMI (DTV)

| Input Signal  | Normal  | 16:9  |
|---|---|---|
|  <p>4:3 Aspect Image</p>   |    |    |
|  <p>Squeezed Image</p>    |   |   |
|  <p>Letter Box Image</p> |  |  |

# Supported Signals



## Important!

Even if a signal is listed in the table below, it does not guarantee that you will be able to display its images correctly.

## RGB Signal

|                | Signal Name     | Resolution  | Horizontal Frequency (kHz) | Vertical Frequency (Hz) |
|----------------|-----------------|-------------|----------------------------|-------------------------|
| <b>VESA</b>    | 640 × 480/60    | 640 × 480   | 31.5                       | 60                      |
|                | 640 × 480/72    | 640 × 480   | 37.9                       | 73                      |
|                | 640 × 480/75    | 640 × 480   | 37.5                       | 75                      |
|                | 640 × 480/85    | 640 × 480   | 43.3                       | 85                      |
|                | 800 × 600/56    | 800 × 600   | 35.2                       | 56                      |
|                | 800 × 600/60    | 800 × 600   | 37.9                       | 60                      |
|                | 800 × 600/72    | 800 × 600   | 48.1                       | 72                      |
|                | 800 × 600/75    | 800 × 600   | 46.9                       | 75                      |
|                | 800 × 600/85    | 800 × 600   | 53.7                       | 85                      |
|                | 1024 × 768/60   | 1024 × 768  | 48.4                       | 60                      |
|                | 1024 × 768/70   | 1024 × 768  | 56.5                       | 70                      |
|                | 1024 × 768/75   | 1024 × 768  | 60.0                       | 75                      |
|                | 1024 × 768/85   | 1024 × 768  | 68.7                       | 85                      |
|                | 1152 × 864/75   | 1152 × 864  | 67.5                       | 75                      |
|                | 1280 × 768/60   | 1280 × 768  | 47.8                       | 60                      |
|                | 1280 × 800/60   | 1280 × 800  | 49.7                       | 60                      |
|                | 1280 × 960/60   | 1280 × 960  | 60.0                       | 60                      |
|                | 1280 × 960/85   | 1280 × 960  | 85.9                       | 85                      |
|                | 1280 × 1024/60  | 1280 × 1024 | 64.0                       | 60                      |
|                | 1280 × 1024/75  | 1280 × 1024 | 80.0                       | 75                      |
|                | 1280 × 1024/85  | 1280 × 1024 | 91.1                       | 85                      |
|                | 1360 × 768/60*1 | 1360 × 768  | 47.7                       | 60                      |
|                | 1366 × 768/60*2 | 1366 × 768  | 47.7                       | 60                      |
|                | 1400 × 1050/A*1 | 1400 × 1050 | 65.3                       | 60                      |
|                | 1440 × 900/60   | 1440 × 900  | 55.9                       | 60                      |
|                | 1600 × 1200/60  | 1600 × 1200 | 75.0                       | 60                      |
| 1680 × 1050/60 | 1680 × 1050     | 65.3        | 60                         |                         |
| <b>Other</b>   | 1152 × 864/70   | 1152 × 864  | 64.0                       | 70                      |
|                | 1400 × 1050/B*1 | 1400 × 1050 | 64.0                       | 60                      |

\*1 If these signals do not project correctly, change the “Option Settings 1 → Auto Adjust” setting to “2” (page 39).

\*2 If this signal does not project correctly, change the “Option Settings 1 → Auto Adjust” setting to “3” (page 39).

## Component Signal

|             | Signal Name | Horizontal Frequency (kHz) | Vertical Frequency (Hz) |
|-------------|-------------|----------------------------|-------------------------|
| <b>HDTV</b> | 1080p/50    | 56.3                       | 50                      |
|             | 1080p/60    | 67.5                       | 60                      |
|             | 720p/50     | 37.5                       | 50                      |
|             | 720p/60     | 45.0                       | 60                      |
|             | 1080i/50    | 28.1                       | 50                      |
|             | 1080i/60    | 33.7                       | 60                      |
| <b>SDTV</b> | 576p/50     | 31.3                       | 50                      |
|             | 576i/50     | 16.6                       | 50                      |
|             | 480p/60     | 31.5                       | 60                      |
|             | 480i/60     | 15.7                       | 60                      |

## Video Signal

| Signal Name | Horizontal Frequency (kHz) | Vertical Frequency (Hz) |
|-------------|----------------------------|-------------------------|
| NTSC        | 15.7                       | 60                      |
| NTSC4.43    | 15.7                       | 60                      |
| PAL         | 15.6                       | 50                      |
| PAL-M       | 15.7                       | 60                      |
| PAL-N       | 15.6                       | 50                      |
| PAL60       | 15.7                       | 60                      |
| SECAM       | 15.6                       | 50                      |

## HDMI Signal

| Signal Name       | Horizontal Frequency (kHz) | Vertical Frequency (Hz) |
|-------------------|----------------------------|-------------------------|
| 640 × 480/60      | 31.5                       | 60                      |
| 800 × 600/60      | 37.9                       | 60                      |
| 1024 × 768/60     | 48.4                       | 60                      |
| 1280 × 768/60     | 47.8                       | 60                      |
| 1280 × 800/60     | 49.7                       | 60                      |
| 1280 × 960/60     | 60                         | 60                      |
| 1280 × 1024/60    | 64                         | 60                      |
| 1400 × 1050/60    | 65.3                       | 60                      |
| SDTV (480p)       | 31.5                       | 60                      |
| SDTV (576p)       | 31.25                      | 50                      |
| HDTV (720p) (50)  | 37.5                       | 50                      |
| HDTV (720p) (60)  | 45                         | 60                      |
| HDTV (1080i) (50) | 28.13                      | 50                      |
| HDTV (1080i) (60) | 33.75                      | 60                      |
| HDTV (1080p) (50) | 56.25                      | 50                      |
| HDTV (1080p) (60) | 67.5                       | 60                      |

# Specifications

| Model Name               | XJ-A141/XJ-A146   | XJ-A241/XJ-A246  | XJ-A251/XJ-A256 |
|--------------------------|---|--|-----------------|
| Brightness (ANSI Lumens) | 2500  |  | 3000            |
| Projection System        | DLP   |  |                 |
| DLP chip                 | Size: 0.55 inch,<br>Number of Pixels: XGA<br>(1024 × 768)   | Size: 0.65 inch,<br>Number of Pixels: WXGA<br>(1280 × 800) |                 |
| Projection Lens          | Optical 2X zoom, electric focus   |  |                 |
| Light Source             | Laser and LED   |  |                 |
| Terminals                | <b>COMPUTER:</b> RGB 15-pin mini D-Sub × 1 (Also used as component signal input terminal.)<br><b>AV:</b> Audio (stereo) input/output and video input, 3.5 φ mini jack × 1<br><b>HDMI:</b> HDMI type A terminal × 1<br><b>SERIAL:</b> For RS-232C control, special terminal × 1<br><b>USB:</b> TYPE A terminal × 1 |  |                 |
| Display Languages        | English, French, German, Italian, Spanish, Swedish, Portuguese, Turkish, Russian, Chinese (Simplified), Chinese (Traditional), Korean, Japanese   |  |                 |

\* XJ-A146/XJ-A246/XJ-A256 only

- CASIO COMPUTER CO., LTD. makes no guarantees concerning the operation or suitability of any USB device that you connect to the projector's USB port.
- Specifications are subject to change without notice.

**CASIO®**

**CASIO COMPUTER CO., LTD.**  
6-2, Hon-machi 1-chome  
Shibuya-ku, Tokyo 151-8543, Japan

MA1202-B

© 2012 CASIO COMPUTER CO., LTD.