

# Panasonic®

■ This product is eligible for the P2HD 5 Year Warranty Repair Program. For details, see page 6.

## Operating Instructions

### Memory Card Portable Recorder

Model No. **AG-HPG20P**  
Model No. **AG-HPG20E**

# P2HD

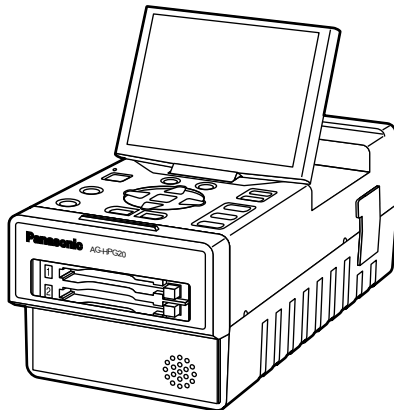

**AVC INTRA**

**DVC PRO HD**

**DVC PRO 50**

**DVC PRO**

**IX**

**FRANÇAIS**

Pour des explications en français, veuillez vous reporter au CD-ROM fourni.

**ESPAÑOL**

Para la explicación en español, consulte el CD-ROM suministrado.

Before operating this product, please read the instructions carefully and save this manual for future use.

F0109T0 -M □  
Printed in Japan

**ENGLISH**

VQT1X51

Introduction

Name of the parts

Preparations

Playback

Recording

Saving data

Editing

Displays

Menu

For your reference

# Read this first!

 indicates safety information.



**CAUTION**  
**RISK OF ELECTRIC SHOCK**  
**DO NOT OPEN**



CAUTION: TO REDUCE THE RISK OF ELECTRIC SHOCK, DO NOT REMOVE COVER (OR BACK). NO USER-SERVICEABLE PARTS INSIDE. REFER TO SERVICING TO QUALIFIED SERVICE PERSONNEL.



The lightning flash with arrowhead symbol, within an equilateral triangle, is intended to alert the user to the presence of uninsulated "dangerous voltage" within the product's enclosure that may be of sufficient magnitude to constitute a risk of electric shock to persons.



The exclamation point within an equilateral triangle is intended to alert the user to the presence of important operating and maintenance (servicing) instructions in the literature accompanying the appliance.

## WARNING:

- TO REDUCE THE RISK OF FIRE OR SHOCK HAZARD, DO NOT EXPOSE THIS EQUIPMENT TO RAIN OR MOISTURE.
- TO REDUCE THE RISK OF FIRE OR SHOCK HAZARD, KEEP THIS EQUIPMENT AWAY FROM ALL LIQUIDS. USE AND STORE ONLY IN LOCATIONS WHICH ARE NOT EXPOSED TO THE RISK OF DRIPPING OR SPLASHING LIQUIDS, AND DO NOT PLACE ANY LIQUID CONTAINERS ON TOP OF THE EQUIPMENT.

## WARNING:

Always keep memory cards out of the reach of babies and small children.

## CAUTION:

TO REDUCE THE RISK OF FIRE OR SHOCK HAZARD AND ANNOYING INTERFERENCE, USE THE RECOMMENDED ACCESSORIES ONLY.

## CAUTION:

Excessive sound pressure from earphones and headphones can cause hearing loss.

## CAUTION:

THE MAINS PLUG OF THE POWER SUPPLY CORD SHALL REMAIN READILY OPERABLE.

THE AC RECEPTACLE (MAINS SOCKET OUTLET) SHALL BE INSTALLED NEAR THE EQUIPMENT AND SHALL BE EASILY ACCESSIBLE.

TO COMPLETELY DISCONNECT THIS EQUIPMENT FROM THE AC MAINS, DISCONNECT THE POWER CORD PLUG FROM THE AC RECEPTACLE.

## CAUTION:

Danger of explosion or fire if battery is mistreated.

### For Battery Pack

- Replace only with same or specified type.
- Do not disassemble or dispose of in fire.
- Do not store in temperatures over 60°C (140°F).
- Use specified charger.
- Do not leave the battery in an automobile exposed to direct sunlight for a long period of time with doors and windows closed.

### Memory Card Portable Recorder

The rating plate is on the underside of the unit.

### AC Adapter

The rating plate is on the underside of the AC Adapter.

Disconnect the AC mains plug from the AC mains socket when not in use.

## CAUTION:

In order to maintain adequate ventilation, do not install or place this unit in a bookcase, built-in cabinet or any other confined space. To prevent risk of electric shock or fire hazard due to overheating, ensure that curtains and any other materials do not obstruct the ventilation.

## FCC NOTICE (USA)

### Declaration of Conformity

Model Number: AG-HPG20P

Trade Name: Panasonic

Responsible Party: Panasonic Corporation of North America One Panasonic Way, Secaucus, NJ 07094

Support contact: Panasonic Broadcast & Television Systems Company 1-800-524-1448

This device complies with Part 15 of FCC Rules.

Operation is subject to the following two conditions:

(1) This device may not cause harmful interference, and (2) this device must accept any interference received, including interference that may cause undesired operation.

To assure continued compliance, follow the attached installation instructions and do not make any unauthorized modifications.

### CAUTION:

This equipment has been tested and found to comply with the limits for a Class B digital device, pursuant to Part 15 of the FCC Rules. These limits are designed to provide reasonable protection against harmful interference in a residential installation. This equipment generates, uses and can radiate radio frequency energy and, if not installed and used in accordance with the instructions, may cause harmful interference to radio communications. However, there is no guarantee that interference will not occur in a particular installation. If this equipment does cause harmful interference to radio or television reception, which can be determined by turning the equipment off and on, the user is encouraged to try to correct the interference by one of the following measures:

- Reorient or relocate the receiving antenna.
- Increase the separation between the equipment and receiver.
- Connect the equipment into an outlet on a circuit different from that to which the receiver is connected.
- Consult the dealer or an experienced radio/TV technician for help.

The user may find the booklet "Something About Interference" available from FCC local regional offices helpful.

### FCC Warning:

To assure continued FCC emission limit compliance, follow the attached installation instructions and the user must use only shielded interface cables when connecting to host computer or peripheral devices. Also any unauthorized changes or modifications to this equipment could void the user's authority to operate this device.

## NOTIFICATION (Canada)

This class B digital apparatus complies with Canadian ICES-003.

## Operating precaution

Operation near any appliance which generates strong magnetic fields may give rise to noise in the video and audio signals. If this should be the case, deal with the situation by, for instance, moving the source of the magnetic fields away from the unit before operation.

## IMPORTANT

"Unauthorized recording of copyrighted television programs, video tapes and other materials may infringe the right of copyright owners and be contrary to copyright laws."

## Read this first! (continued)

For U.K.

 indicates safety information.

# Caution for AC Mains Lead

**FOR YOUR SAFETY PLEASE READ THE FOLLOWING TEXT CAREFULLY.**

This product is equipped with 2 types of AC mains cable. One is for continental Europe, etc. and the other one is only for U.K.

Appropriate mains cable must be used in each local area, since the other type of mains cable is not suitable.

**FOR CONTINENTAL EUROPE, ETC.**  
Not to be used in the U.K.

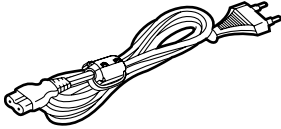

**FOR U.K. ONLY**

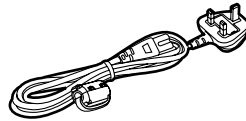



**FOR U.K. ONLY**

This appliance is supplied with a moulded three pin mains plug for your safety and convenience.

A 5 amp fuse is fitted in this plug.

Should the fuse need to be replaced please ensure that the replacement fuse has a rating of 5 amps and that it is approved by ASTA or BSI to BS1362.

Check for the ASTA mark  or the BSI mark  on the body of the fuse.

If the plug contains a removable fuse cover you must ensure that it is refitted when the fuse is replaced.

If you lose the fuse cover the plug must not be used until a replacement cover is obtained.

A replacement fuse cover can be purchased from your local Panasonic Dealer.

**How to replace the fuse**

1. Open the fuse compartment with a screwdriver.

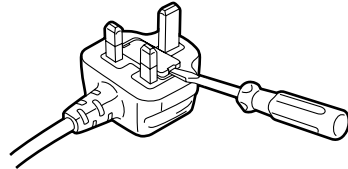

2. Replace the fuse

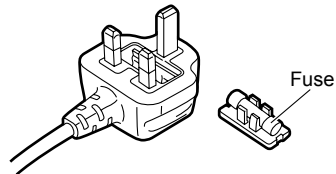

**For USA and Canada**



A lithium ion/polymer battery that is recyclable powers the product you have purchased. Please call 1-800-8-BATTERY for information on how to recycle this battery.



# IMPORTANT SAFETY INSTRUCTIONS

- 1) Read these instructions.
- 2) Keep these instructions.
- 3) Heed all warnings.
- 4) Follow all instructions.
- 5) Do not use this apparatus near water.
- 6) Clean only with dry cloth.
- 7) Do not block any ventilation openings. Install in accordance with the manufacturer's instructions.
- 8) Do not install near any heat sources such as radiators, heat registers, stoves, or other apparatus (including amplifiers) that produce heat.
- 9) Do not defeat the safety purpose of the polarized or grounding-type plug. A polarized plug has two blades with one wider than the other. A grounding-type plug has two blades and a third grounding prong. The wide blade or the third prong are provided for your safety. If the provided plug does not fit into your outlet, consult an electrician for replacement of the obsolete outlet.
- 10) Protect the power cord from being walked on or pinched particularly at plugs, convenience receptacles, and the point where they exit from the apparatus.
- 11) Only use attachments/accessories specified by the manufacturer.
- 12) Use only with the cart, stand, tripod, bracket, or table specified by the manufacturer, or sold with the apparatus. When a cart is used, use caution when moving the cart/apparatus combination to avoid injury from tip-over.
- 13) Unplug this apparatus during lightning storms or when unused for long periods of time.
- 14) Refer all servicing to qualified service personnel. Servicing is required when the apparatus has been damaged in any way, such as power-supply cord or plug is damaged, liquid has been spilled or objects have fallen into the apparatus, the apparatus has been exposed to rain or moisture, does not operate normally, or has been dropped.



## **Recommendation for Use of Genuine Panasonic Battery (Rechargeable Battery)**

Thank you for using a Panasonic product.

It has been found that counterfeit battery packs which look very similar to the genuine product are made available to purchase in some markets. Some of these battery packs are not adequately protected with internal protection to meet the requirements of appropriate safety standards. There is a possibility that these battery packs may lead to fire or explosion. Please be advised that we are not liable for any accident or failure occurring as a result of use of a counterfeit battery pack. To ensure that safe products are used we would recommend that a genuine Panasonic battery pack is used.

- Be aware that many batteries sold at extremely cheap prices or in situations where it is difficult to verify the actual products before purchase have proven to be counterfeit.



## To remove the battery

### Main Power Battery

Remove the battery while pressing the battery eject button.

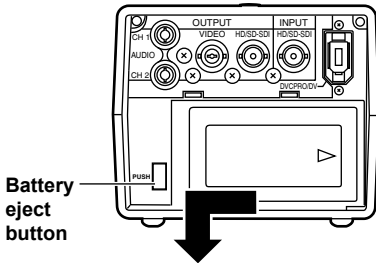

### Back-up Battery (Lithium Battery)

For the removal of the battery for disposal at the end of its service life, please consult your dealer.

## P2HD 5 Year Warranty Repair Program\*1

Thank you for purchasing this Panasonic P2HD device.

Register as a user for this device to receive a special service warranty up to five years of free warranty repairs.

Customers who register as users on the website will receive an extended warranty repair valid for up to five years.



	1st year	2nd year	3rd year	4th year	5th year*5
P2HD device*2	Basic warranty*3	Extended warranty repair*4			

\*1: Please note that this extended warranty is not available in some countries/regions.

\*2: Not all models eligible for extended warranty coverage.

\*3: The basic warranty period may vary depending on the country/region.

\*4: Not all repair work is covered by this extended warranty.

\*5: The maximum warranty period may be adjusted depending on the number of hours the device has been used.



Purchase P2 product



Register online within 1 month



"Registration Notice" e-mail sent

Free 5 years of Warranty Repairs

Make sure to save the "Registration Notice" e-mail during the warranty period.

Details about user registration and the extended warranty:

 [http://panasonic.biz/sav/pass\\_e/](http://panasonic.biz/sav/pass_e/)

Please note, this is a site that is not maintained by Panasonic Canada Inc. The Panasonic Canada Inc. privacy policy does not apply and is not applicable in relation to any information submitted. This link is provided to you for convenience.

# EMC NOTICE FOR THE PURCHASER/USER OF THE APPARATUS

## 1. Applicable standards and operating environment for AG-HPG20E

### The apparatus is compliant with:

- standards EN55103-1 and EN55103-2 1996, and
- electromagnetic environments E1, E2, E3, E4 and E5.

## 2. Pre-requisite conditions to achieving compliance with the above standards

### <1> Peripheral equipment to be connected to the apparatus and special connecting cables

- The purchaser/user is urged to use only equipment which has been recommended by us as peripheral equipment to be connected to the apparatus.
- The purchaser/user is urged to use only the connecting cables described below.

### <2> For the connecting cables, use shielded cables which suit the intended purpose of the apparatus.

- Video signal connecting cables  
Use double shielded coaxial cables, which are designed for 75-ohm type high-frequency applications, for SDI (Serial Digital Interface).  
Coaxial cables, which are designed for 75-ohm type high-frequency applications, are recommended for analog video signals.
- Audio signal connecting cables  
If your apparatus supports AES/EBU serial digital audio signals, use cables designed for AES/EBU.  
Use shielded cables, which provide quality performance for high-frequency transmission applications, for analog audio signals.
- Other connecting cables (IEEE1394, USB)  
Use shielded cables, which provide quality performance for high-frequency applications, as connecting cables.
- If your apparatus is supplied with ferrite core(s), they must be attached on cable(s) following instructions in this manual.

## 3. Performance level

The performance level of the apparatus is equivalent to or better than the performance level required by these standards.

However, the apparatus may be adversely affected by interference if it is being used in an EMC environment, such as an area where strong electromagnetic fields are generated (by the presence of signal transmission towers, cellular phones, etc.). In order to minimize the adverse effects of the interference on the apparatus in cases like this, it is recommended that the following steps be taken with the apparatus being affected and with its operating environment:

1. Place the apparatus at a distance from the source of the interference.
2. Change the direction of the apparatus.
3. Change the connection method used for the apparatus.
4. Connect the apparatus to another power outlet where the power is not shared by any other appliances.

# Operating precautions

---

**When using the unit in rainy or snowy weather, at the beach or other locations, take care to protect it from precipitation and sea water.**

- Otherwise, trouble may occur in the unit and its cards. (It may not be possible to restore the original functions)

**Keep the unit away from appliances (such as TV sets and TV game machines) which generate magnetic fields.**

- When the unit is used on top of or near a TV set, the images and sound may be distorted by the electromagnetic waves emanating from the TV set.
- Strong magnetic fields generated by speakers or large motors may damage the recordings or distort the images.
- The electromagnetic waves emanating from microprocessors may adversely affect the unit and distort the images and sound.
- If the unit is adversely affected by an appliance that generates magnetic fields and fails to operate properly as a result, turn off its power, and either remove its battery or unplug the AC adapter from the power outlet. Then install the battery again or re-connect the AC adapter. After doing this, turn the unit's power back on.

**Do not use the unit near a radio transmitter or high-voltage appliance.**

- Doing so may adversely affect the recorded images and sound.

**When using the unit at the beach or similar locations, take care to protect it from sand and dust.**

- Sand and dust may damage the unit and its cards. (Take particular care when inserting or ejecting the cards)

**AC adapter and battery**

- When the battery temperature is extremely high or extremely low or when the battery has not been used for a prolonged period and been left discharged, the [CHARGE] lamp will blink several times, and charging will start automatically.
- If the [CHARGE] lamp continues blinking even when the battery temperature is normal, this may be a sign of trouble in the battery or AC adapter. Consult with your dealer.
- When the battery is warm, it will take longer than usual to recharge it.
- When the AC adapter is used near a radio, the sound from the radio may be distorted. Use the AC adapter and radio at a distance of at least 1 meter from each other.
- Noise is output while the AC adapter is being used, but this is not a sign of trouble.

**When carrying the unit around, take care not to drop it.**

- Strong impacts may damage the unit's body, preventing it from operating properly.

**Do not expose the unit to insecticides or volatile sprays or liquids.**

- These substances may deform the unit's body or cause its paint to peel off.
- Do not bring the unit into contact with products made of rubber or vinyl for prolonged periods of time.

---

### **Characteristics of the battery**

A rechargeable lithium-ion battery is used in this unit. Electrical energy is generated by the chemical reactions taking place inside it. These reactions are susceptible to the effects of the ambient temperature and humidity, and the higher or the lower the temperature, the quicker the battery charge will be used up. When the battery is used where the temperature is extremely low, it may last only 5 minutes or so even if the battery has been fully charged.

When the battery reaches an extremely high temperature, its protection function is activated, making it impossible for the battery to be used for a while.

### **After using the unit, always remember to remove the battery.**

Be sure to remove the battery from the unit. (If it is left in place, a very faint current will continue to flow even when the unit's power has been turned off) If the battery is left in place for a prolonged period, it may discharge excessively so that it cannot be used again even when it is charged at a later time.

### **Protect the battery terminals.**

Keep the battery terminals free from dust and foreign matter.

If the battery has been inadvertently dropped, check whether its body and terminal area have been deformed.

Installing a deformed battery in the unit or in the AC adapter may damage the unit or AC adapter.

### **Precautions when P2 cards and SD cards are to be destroyed or given to other parties**

The formatting and deletion functions provided by the unit and personal computers serve merely to change the file management information: they will not completely erase all the data on the card.

When a card is to be destroyed or given to another party, it is recommended that you destroy the actual card physically or use a data deletion software program for use with personal computers available on the market to completely erase all the data on the card.

You, the user, are responsible for managing the data on your cards.

### **Liquid crystal display**

- When the same image or characters are left displayed on the LCD monitor for a prolonged period, they may become burned into the screen. However, the original condition of the screen will be restored after the power has been kept off for several hours.
- The liquid crystal part of the monitor has been fabricated using high-precision technology. The number of its effective pixels is more than 99.99 %, but this still leaves less than 0.01 % of its pixels which may be missing or permanently lighted. This is not a sign of trouble and will have absolutely no effect on the images which have been recorded.
- The surface of the liquid crystal display may be marked or scratched if it is wiped or rubbed firmly with a rough cloth.
- The response speed and brightness of the liquid crystal change depending on the temperature at which the display is used.
- Condensation may form on the liquid crystal part of the monitor if the unit is placed in a location where there is a significant difference in the temperature levels. If this happens, wipe off the condensation with a soft dry cloth.
- If the unit becomes very cold, the LCD monitor screen will be darker than usual immediately after the power has been turned on. When the temperature inside the unit rises, the normal brightness will be restored.

### **Connector protection**

Attach the connector covers when the connectors are not in use.

# Contents

Read this first! .....	2
<b>IMPORTANT SAFETY INSTRUCTIONS</b> .....	5
<b>Recommendation for Use of Genuine Panasonic Battery (Rechargeable Battery)</b> .....	5
<b>Operating precautions</b> .....	8
<b>How to use the unit</b> .....	12

## Introduction

<b>About this manual</b> .....	15
<b>Before use</b> .....	15
<b>Accessories</b> .....	17

## Name of the parts

<b>Name of the parts</b> .....	18
Operation area .....	18
Mechanism area and input/output connector area .....	19

## Preparations

<b>Charging the battery</b> .....	20
Charging .....	20
<b>Installing and removing the power supply</b> .....	21
Installing and removing the battery .....	21
Connecting and disconnecting the power cable .....	21
<b>Basic operations</b> .....	22
Turning the power on and off .....	22
Using the LCD monitor .....	22
Menu operations .....	23
Operation modes .....	24
LCD monitor settings .....	26
Setting date and time .....	27
<b>P2 cards</b> .....	28
Inserting P2 cards .....	28
P2 card access LED and P2 card status .....	28
Formatting P2 cards .....	29
P2 card protection .....	29
Ejecting P2 cards .....	30
P2 card recording durations .....	31
Dividing clips over 4 GB in size .....	31
LOOP REC recording .....	32
<b>Other</b> .....	32
USER button .....	32
Charging the internal battery .....	32
<b>Using SD/SDHC memory cards</b> .....	33
Inserting and removing the SD card .....	33
Formatting SD cards .....	33
Precaution for using SD cards .....	33
<b>Saving USER files on SD cards</b> .....	34

## Playback

<b>Thumbnail display</b> .....	35
Playback formats .....	35
Names and functions of thumbnail display screen parts .....	35
Changing the displays on the thumbnail display screen .....	38
Setting the items to be displayed .....	39
<b>Clip management</b> .....	40
Selecting clips .....	40
Deleting clips .....	40
Repairing and connecting clips .....	41
Copying clips .....	42
Displaying the clip information .....	43
Editing the clip information .....	45
Adding meta-data to clips .....	46
Adding shot marks to clips .....	54
Displaying the P2 card status .....	54
Displaying SD card information .....	56
<b>Clip playback</b> .....	57
Playing back clips .....	57
Single clip playback .....	58
Variable-speed playback .....	59
Clip and text memo forward/reverse .....	59
Rapid forward/rapid reverse playback .....	59
Frame feed playback .....	59
Repeat playback .....	59
Adding text memos .....	60
Playback from text memo position .....	60
Deleting text memos .....	61
Dividing and copying clips using text memos ..	61
Replacing thumbnail images .....	61
<b>Outputting images to an external monitor for playback</b> .....	62
Setting the outputs .....	62
Adjusting the output volume level during recording and playback .....	62
Adjusting the output volume level during variable-speed playback .....	62

## Recording

<b>Recording data on P2 cards</b> .....	63
Recording .....	63
2-slot continuous recording .....	64
Waveform monitor (WFM) displays .....	64
Time code displays .....	65
Setting the recording time code .....	65
Set the user's bit .....	66

## Saving data

<b>Copying data from P2 cards to the hard drive .....</b>	<b>67</b>
Switching to the USB HOST mode.....	68
Usable hard drives .....	68
Types of hard drives and usable functions.....	69
Formatting the hard drive .....	70
Exporting data to a hard drive in 1-card increments.....	71
Exporting one clip at a time to a hard drive.....	72
Hard drive data display.....	74
Deleting the partition .....	75
Thumbnail displays of clips on the hard drive... 76	
Displaying the clip information on the hard drive .....	76
<b>Connecting the hard drive for use.....</b>	<b>77</b>
Importing data from a hard drive to P2 cards... 77	
Easy playback of clips on the hard drive (For viewing materials).....	78
Deleting clips on the hard drive .....	78

## Editing

<b>Editing by means of external devices .....</b>	<b>79</b>
Editing data content on the P2 card (USB DEVICE mode) .....	79
Editing in the USB DEVICE mode.....	79

## Displays

<b>Screen displays .....</b>	<b>80</b>
Normal displays.....	80
Major warning displays.....	82
Selecting what is to be displayed on the screen.....	85
<b>Recording/output supporting format.....</b>	<b>86</b>

## Menu

<b>Basic operations on the setting menus .....</b>	<b>88</b>
Initializing the setting menu.....	88
<b>Setting menu configuration.....</b>	<b>89</b>
<b>List of setting menus .....</b>	<b>90</b>
RECORDING SETUP screen.....	90
TIMECODE SETUP screen.....	93
SW MODE screen.....	97
PLAYBACK FUNCTIONS screen.....	98
AV OUT SETUP screen.....	99
DISPLAY SETUP screen.....	103
CARD FUNCTIONS screen .....	105
OTHER FUNCTIONS screen .....	106
DIAGNOSTIC screen .....	107
OPTION MENU screen .....	108

## For your reference

<b>Warning system table .....</b>	<b>109</b>
<b>Troubleshooting (Q&amp;A).....</b>	<b>110</b>
<b>Software information for this product.....</b>	<b>112</b>
<b>Updating the drivers installed in the unit.....</b>	<b>113</b>
<b>Maintenance.....</b>	<b>113</b>
<b>Condensation.....</b>	<b>113</b>
<b>Storage precautions.....</b>	<b>114</b>
<b>Handling the data recorded on P2 cards .....</b>	<b>115</b>
<b>Use of SD/SDHC memory cards.....</b>	<b>116</b>
<b>Specifications .....</b>	<b>117</b>

# How to use the unit

Housed in a compact cabinet which can be battery-powered, this Memory Card Portable Recorder is a compact recording/playback unit coming with two P2 card slots, a 3.5-inch LCD monitor, USB 2.0, IEEE1394, composite signal, SDI and many other input/output signal connectors. It can be easily operated to play back the data content which has been shot by a P2 camera recorder. It is also capable of backup recording and file management, and it supports outdoor field recording.

## Playing back data content on the P2 card

### 1 Playing back the data on the unit's LCD monitor (Page 57)

Data content (both pictures and sound) which has been shot on P2 cards using a P2 camera recorder can be played back on the spot.

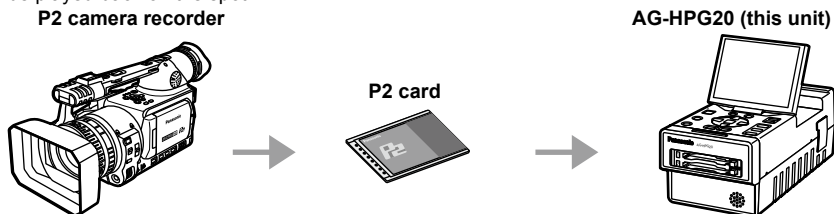

### 2 Outputting the data to the external monitor for playback (Page 62)

The data content (both pictures and sound) on P2 cards can be output to the external monitor, and played back.

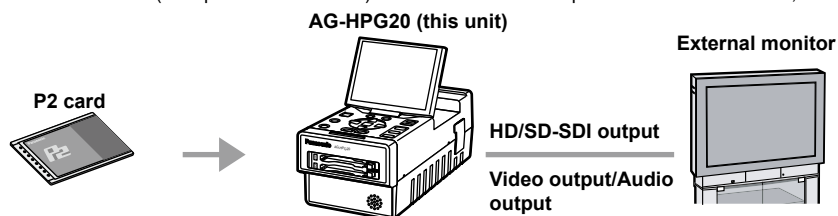

- Use VIDEO/SDI/1394 output for monitoring purpose in other modes than playback mode. It is not suitable for recording purpose because Pictures/Sound/Time cord (TC/UB) may become incorrect.
- If the content on the P2 card has been recorded in DVCPRO HD, DVCPRO50, DVCPRO25 or DV format, signals are also output from DVCPRO/DV input/output connector (IEEE 1394). (AVC-Intra100 and AVC-Intra50 do not support 1394 output)

## Recording data on P2 cards

### 3 1394 connection (Page 63)

You can record data on P2 cards by connecting the unit to the external devices equipped with 1394 (DVCPRO/DV stream) output, such as a P2 camera recorder. The unit's recording start and stop operations can be performed from some camera recorders.

- Recording in AVC-Intra100 and AVC-Intra50 modes is not possible with 1394 input.

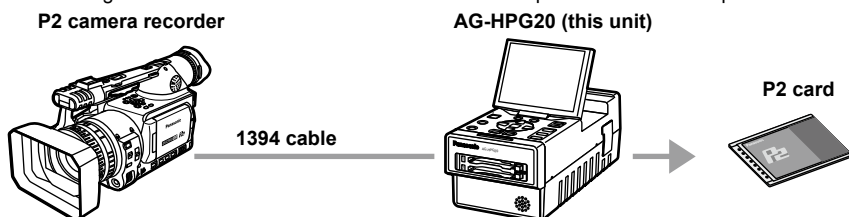



## 4 HD/SD-SDI connection (Page 63)

You can record data on P2 cards by connecting the unit to the external devices equipped with HD/SD-SDI output. The unit's recording start and stop operations can be performed from some camera recorders. (When SDI input is selected)  
(For supporting devices, refer to page 91)

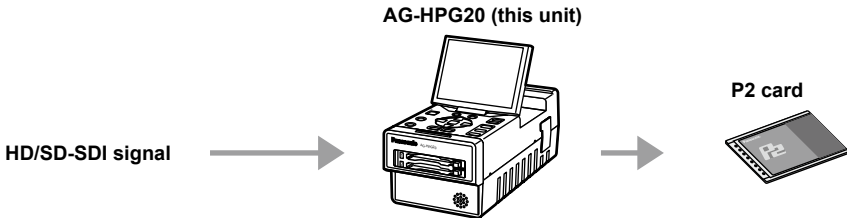

## Using an external hard drive (HDD)

### 5 Saving data onto an external hard drive (Page 67)

The data content on P2 cards can be saved onto an external HDD. Also, the P2 content saved on an external HDD can be reloaded onto a P2 card. (Only in the USB HOST mode)  
• 1394 connection (File transfer) is not supported.

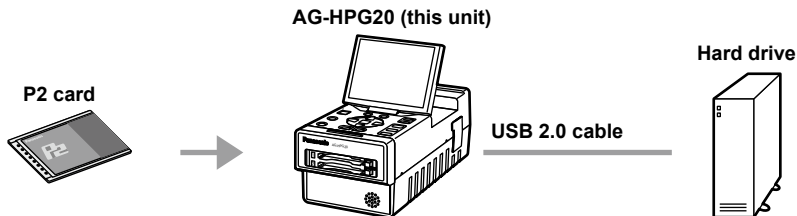

### 6 Checking the content saved onto an external hard drive (Page 78)

The P2 content saved on an external HDD can be played back and checked. (Pull-down playback (Playback with some images skipped))  
(Only in the USB HOST mode)  
• 1394 connection (File transfer) is not supported.  
• Both audio and images will not be output to the DVCPRO/DV input/output connector (IEEE1394).

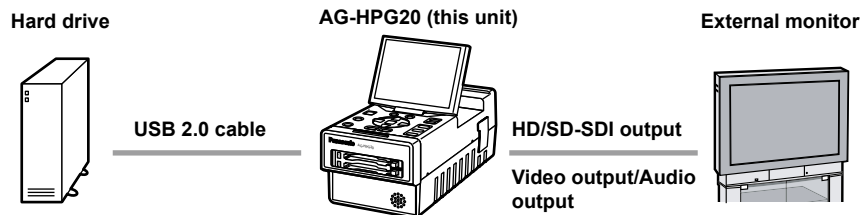

### Using a PC

#### 7 Editing by connecting the unit to a PC (Page 79)

The unit can be USB-connected to a PC, and the PC can then be used to edit (i.e. exchanging data, etc.) the data content on P2 cards. (USB DEVICE mode)

- 1394 connection (File transfer) is not supported.

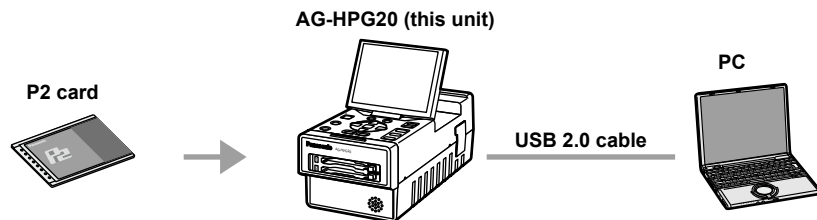

# About this manual

## Note concerning illustrations in these instructions

- Illustrations (portable recorder, menu screens, etc.) in these operating instructions differ slightly from the actual portable recorder.

## References

- References are shown as (Page 15).

Each explanation, company names and product names described in these operating instructions are trademarks or registered trademarks of each company.

## Before use

### Be absolutely sure to check the date, time and time zone, and set them if necessary.

- The calendar and time zone affect the management and playback sequence of the data content which has been recorded. Before recording, set and check year/month/day, time and time zone. (Page 27)

### No compensation can be made for video recordings.

- The manufacturer will not provide any compensation in the event that images fail to be recorded due to trouble while the unit and P2 card are being used.

### Concerning copyrights

- You may use the images and sound which you have recorded for your own personal enjoyment only; under copyright laws, you may not use them for any other purpose without the permission of the copyright holders.

### IEEE1394 cable connection

Be sure to observe the following when connecting the IEEE1394 cable (optional). (Improper connection may cause malfunction in this unit and external devices)

- Before connecting or disconnecting the IEEE1394 cable, you must turn off the power of all devices connected to the unit.  
Devices equipped with earth terminals must be used in the grounded condition (or in the connected condition to the commonly-used GND).
- When connecting the unit to a component which uses a 4-pin type of connector, be sure to connect this unit's connector (6-pin type) first.
- IEEE1394 cable connector has a direction.
- When connecting the unit to a component which uses a 6-pin type of IEEE1394 connector, be sure to check the shape before connection as below

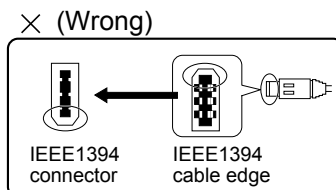
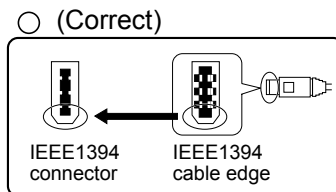

- During recording or playback in AVC-Intra100 and AVC-Intra50 modes, input/output from the DVCPRO/ DV input/output connector (IEEE1394) is not possible.

## Before use (continued)

---

### Media which can be used with this unit

You may use the following media. For further details, refer to the pages on the media concerned.

- P2 cards (Page 28)
- SD/SDHC memory cards (Page 33)

### Screw holes

M5 (5 mm diameter) screws with a length of 10 mm can be used for the four screw holes on the side panels of the unit.



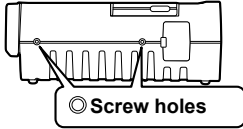



When using the screws, do not tighten them too much. The unit may be damaged if screws other than 10 mm long M5 (5 mm diameter) screws are used.

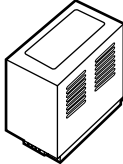
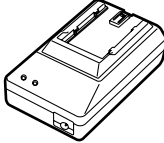

The other side panel also has two screw holes.

Refer to page 8 for other operating precautions.

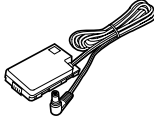
# Accessories

<p><b>Battery*</b></p> 	<p><b>AC adapter</b></p> 	<p><b>AC power supply cords</b></p> <p>AG-HPG20P</p>  <p>AG-HPG20E (For the U.K.)</p>  <p>(For areas other than the U.K.)</p> 	
<p><b>DC cord</b></p> 	<p><b>CD-ROM</b></p> 		

\* For the model number of the battery, refer to the [ACCESSORIES] item. (Page 118)

# Name of the parts

## Operation area

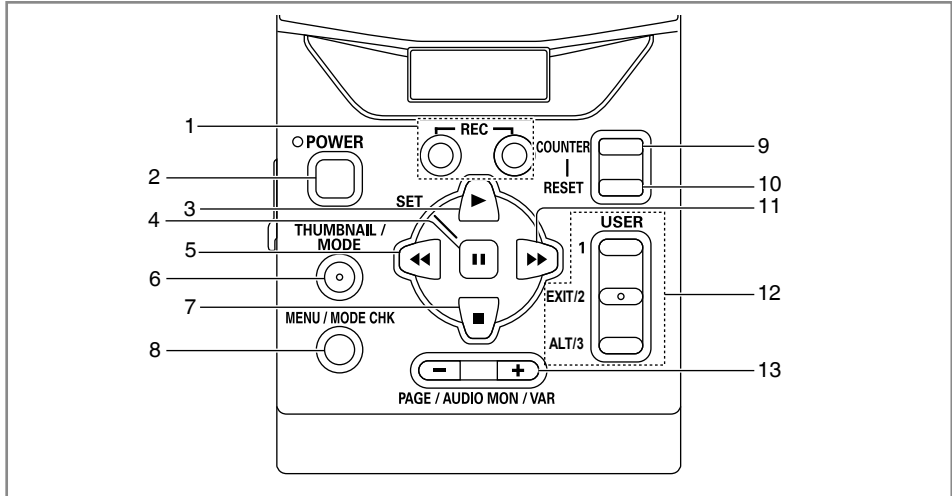

- |  |  |
|--|--|
| 1 REC button (Page 63)                   | 9 COUNTER button (Page 65)                         |
| 2 POWER button (Pages 22, 110)           | 10 RESET button<br>(Pages 26, 34, 65, 66)          |
| 3 PLAY button (Pages 23, 58)             | 11 FF button (Pages 23, 58)                        |
| 4 STILL/SET button (Pages 23, 58)        | 12 USER/EXIT/ALT button (Page 32)                  |
| 5 REW button (Pages 23, 58)              | 13 PAGE/AUDIO MON/VAR button<br>(Pages 40, 59, 62) |
| 6 THUMBNAIL/MODE button<br>(Page 24)     |  |
| 7 STOP button (Pages 23, 58)             |  |
| 8 MENU/MODE CHK button<br>(Pages 23, 32) |  |

• The button names are described such as [THUMBNAIL/MODE] in this manual from now.

## Mechanism area and input/output connector area

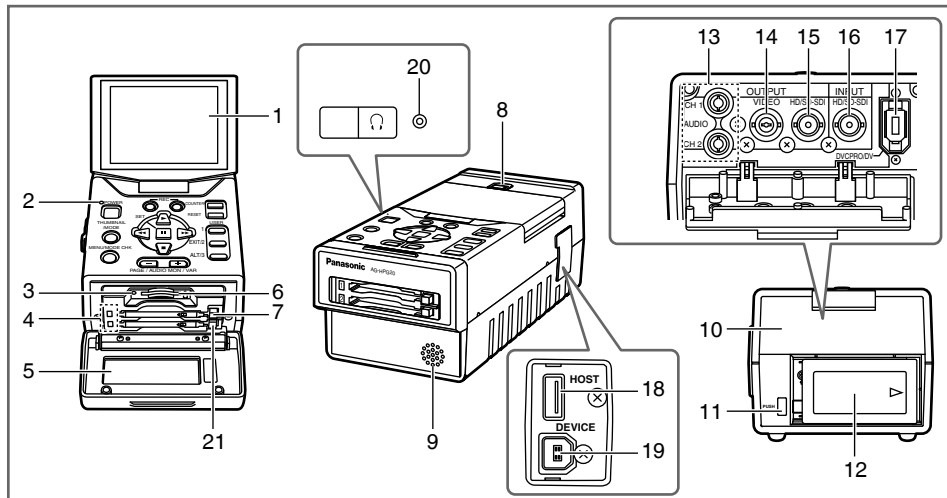

Name of the parts

- |                                     |  |
|-------------------------------------|--|
| 1 LCD monitor (Pages 22, 26)        | 13 AUDIO OUT CH1/CH2 connectors (Page 62)                |
| 2 Power display LED (Pages 22, 109) | 14 VIDEO OUT connector (Page 62)                         |
| 3 SD card access LED (Page 33)      | 15 HD/SD-SDI OUT connector (Page 62)                     |
| 4 P2 card access LEDs (Page 28)     | 16 HD/SD-SDI IN connector (Page 63)                      |
| 5 Card slot cover (Pages 28, 30)    | 17 DVCPRO/DV input/output connector (IEEE1394) (Page 63) |
| 6 SD card slot (Page 33)            | 18 USB HOST connector (USB2.0 Type A) (Page 67)          |
| 7 P2 card slots (Page 28)           | 19 USB DEVICE connector (USB2.0 Type B) (Page 79)        |
| 8 LCD monitor open button (Page 22) | 20 Headphone jack (Pages 62, 82)                         |
| 9 Speaker (Pages 62, 82)            | 21 P2 card eject button (Page 30)                        |
| 10 Connector area cover             |  |
| 11 Battery eject button (Page 21)   |  |
| 12 Battery (Page 20)                |  |

- Use a cable equivalent level of 5C-FB with a double-layer shield to connect to HD/SD-SDI IN or HD/SD-SDI OUT connector.
- Use a cable with a double-layer shield to connect to DVCPRO/DV input/output connector (IEEE1394).

# Charging the battery

## Charging

The battery has not been charged at the time of purchase. Before using the battery, give it a full charge using the AC adapter. It is recommended that you have a spare battery available in case you need it.

### 1 Place the battery horizontally while aligning it with the $\Rightarrow$ mark on the AC adapter, and slide it into position.

- If the DC cord is connected to the AC adapter, disconnect it before proceeding any further. The battery cannot be charged if this cable is left connected.

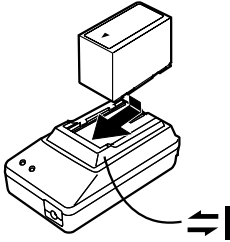

### 2 Connect the AC cable to the power outlet.

- The POWER and CHARGE lamps on the AC adapter light, and charging starts.
- If the CHARGE lamp fails to light when the battery has been installed, remove the battery and then re-install it.

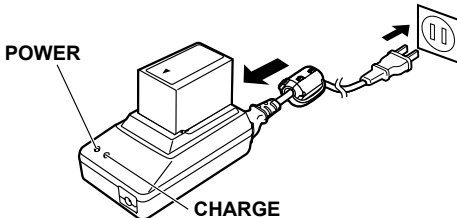

- When the battery has been charged, the CHARGE lamp on the AC adapter goes off.
- Depending on the country and region, the actual configuration of the power cord, plug, and power outlet may differ from those shown in these operating instructions.

### 3 Slide the battery out of position, and remove it.

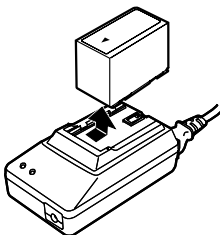

## Charging time and play time of supplied battery

Capacity	Charging time	Continuous playback time
5400 mAh	Approx. 330 minutes	Approx. 230 minutes

- The times given in the above table are approximate figures based on playback in the AVC-Intra100 mode.
- The times given in the above table are obtained at an ambient operating temperature of 20 °C (68 °F) and an ambient relative humidity of 60 %. It may take longer to charge the battery at other temperature and humidity levels.

- While the battery is being used or charged, it will become hot.
- If the playback and stop operations are repeated more than necessary, the playback time will be shorter than the time given in the above table. When the battery is to be stored for a prolonged period, it is recommended that you charge it once a year, use the battery in the unit until its charge is used up, and then return it to storage.
- When the battery temperature becomes extremely high or low or when a discharged battery has been left unused for a prolonged time, the CHARGE lamp will blink several times, and charging will commence automatically.
- When the CHARGE lamp continues to blink even when the battery is at the right temperature, it may indicate a failure in the battery or AC adapter. Contact your dealer.
- When the battery is warm, it will take longer than usual to recharge it.
- When the AC adapter is used near a radio, the sound from the radio may be distorted. Use the AC adapter and radio at a distance of at least 1 meter from each other.
- Noise may be heard from the AC adapter while the AC adapter is being used: this is normal and not a sign of trouble.
- The battery cannot be charged when power is supplied to the unit from the AC adapter.
- No guarantees are given for the operation of the CGR-D16/CGR-D16s (1600 mAh) battery pack.



# Installing and removing the power supply

## Installing and removing the battery

### Insertion

- 1 Slide and insert the battery until it clicks into place.

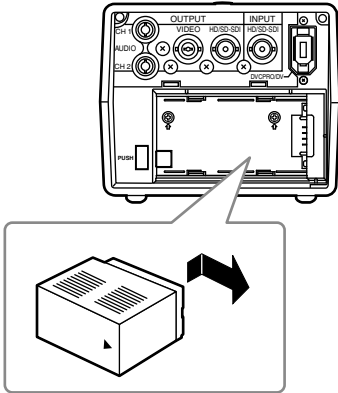

### Removal

- 1 Press [POWER] for at least 2 seconds to turn the power off, and check that the power display LED has gone off. (Page 22)
- 2 Remove the battery while pressing the battery eject button.
  - Support the battery with your hand to ensure that it will not drop down.

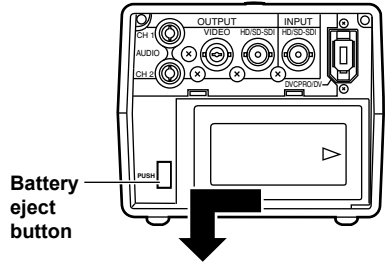

Preparations

## Connecting and disconnecting the power cable

### Insertion

- 1 Connect the DC cord to the AC adapter.
- 2 Connect the AC power supply cord into the power outlet.
- 3 Slide and insert the DC cord plate until it clicks into place.

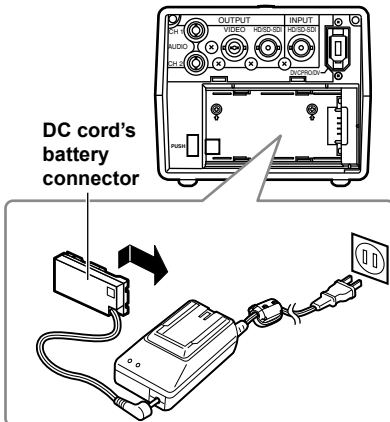

### Removal

- 1 Press [POWER] for at least 2 seconds to turn the power off, and check that the power display LED has gone off. (Page 22)
- 2 Remove the DC cord's battery connector while pressing the battery eject button.
- 3 Disconnect the AC power supply cord from the power outlet.

- The battery cannot be charged when power is supplied to the unit from the AC adapter.
- The AC adapter is designed to work anywhere in the world with supply voltages ranging from 100 V to 240 V and with power line frequencies of 50 Hz and 60 Hz. However, in some countries the shape of the power outlet receptacle differs. In cases like this, obtain the plug that will fit the receptacle. Obtain the conversion plugs after consulting with your dealer.
- When the unit is not being used, disconnect the AC cable from the power outlet.

# Basic operations

## Turning the power on and off

Hold down [POWER] for at least 1 second.

- The power display LED lights, and the power is turned on.
- When [POWER] has been held down for more than 2 seconds while the power is on, the power display LED will go off, and the power will be turned off.

## Using the LCD monitor

**1** Hold down [POWER] for at least 1 second to turn the power on.

**2** Raise the LCD monitor while pressing the LCD monitor open button in the direction shown by the arrow.

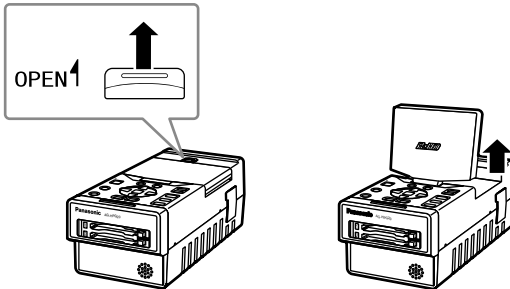

**3** Set the LCD screen to the angle where it is easiest to see its displays.

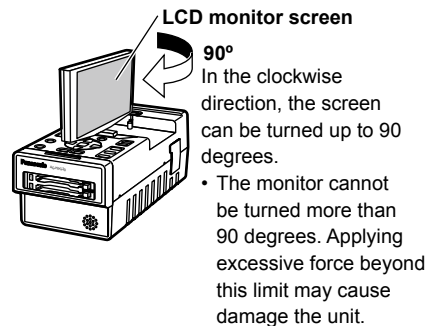
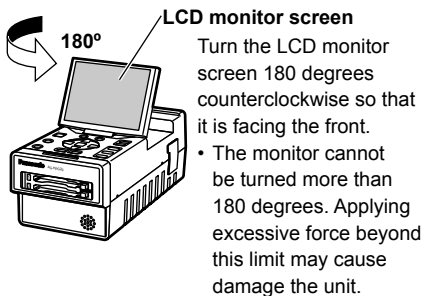

Make sure that the LCD monitor is raised upright before turning it.

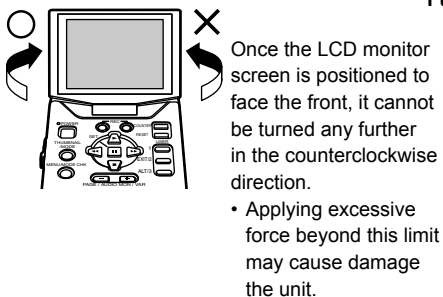

### Function buttons

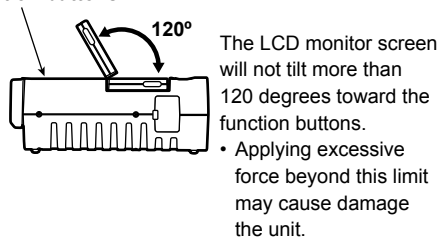

## Menu operations

This unit is provided with three kinds of screens: the thumbnail display screen, normal display screen (SDI/1394 input recording standby mode, INT SG (Page 91), playback standby mode, etc.) and PC mode screen (USB HOST mode, USB DEVICE mode). When [MENU/MODE CHK] is pressed on any of these screens, the menu will be displayed. (No menus are displayed in the USB DEVICE mode)

### Operations performed when the function buttons are pressed

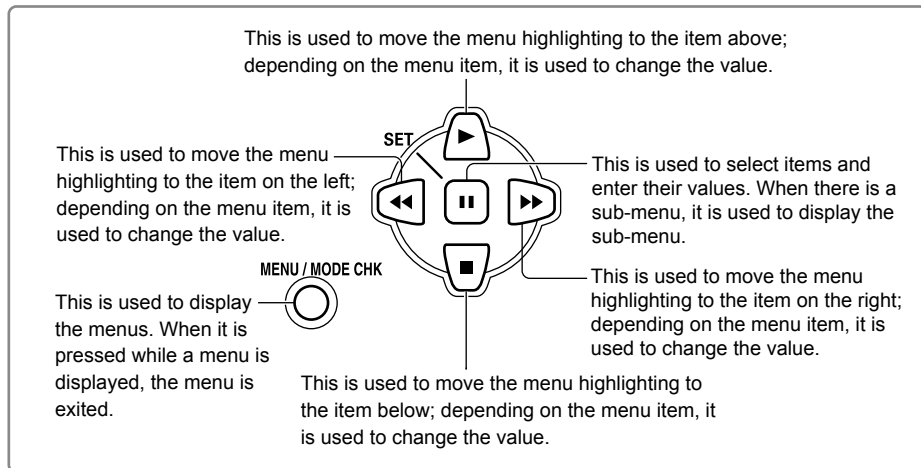

When EXIT is assigned to [EXIT/2], if you press [EXIT/2] while a menu is displayed, the menu is exited.

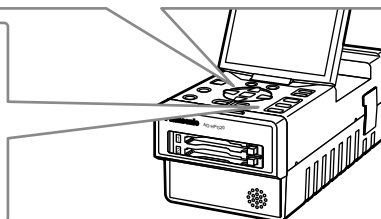
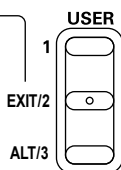

### Example of a menu operation: (when the thumbnail display screen is displayed)

#### 1 Press [MENU/MODE CHK] to display the menu.



#### 2 Press $\nabla$ and $\triangle$ to move the menu highlighting, and select the item.

#### 3 Press $\blacksquare$ .

- If another menu has been displayed, repeat steps 2 and 3.
- Depending on the item, the value is changed using  $\nabla$ ,  $\triangle$ ,  $\triangleright$  and  $\triangleleft$ .
- Depending on the item, a confirmation screen will be displayed.
- Depending on the item, the original screen is restored automatically.

#### 4 Press [MENU/MODE CHK] to exit the menu.

For details on the menu operations on the normal display screen, refer to "Basic operations on the setting menus" on page 88.

# Basic operations (continued)

## Operation modes

This unit has the following 3 modes which can be selected by pressing [THUMBNAIL/MODE].

**POWER**



Turn on the power.

**Thumbnail display screen**

On this screen, the data content on the P2 cards is displayed as thumbnails to play back or manage the clips.



Playback (PLAY, STILL, FF, REW)

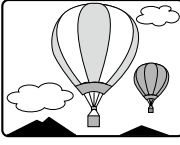

Stop (STOP)



Hold down this button for at least 2 seconds to switch to the PC mode.



When a P2 card has been ejected



**Normal display screen**

- Connect the unit to the devices equipped with the HD/SD-SDI input/output or IEEE1394 connector, or set INT SG (Page 91) for playback and recording.



Playback



Recording



• Display the menu, and perform the various settings.

**CARD FUNCTIONS**

USER FILE	RETURN
SD CARD FORMAT	CHANGE



Hold down this button for at least 2 seconds to switch to the PC mode.

■ PC mode

Connect the unit to an external device, and save or manage the clips. Depending on the connection method and purpose, the USB HOST mode and USB DEVICE mode are available; perform the mode settings using the setting menu on the normal display screen.

• USB HOST mode

Connect to a device equipped with a USB connector, and operate the connected device.

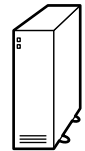

• USB DEVICE mode

Connect to a device equipped with a USB connector, and operate the data on the unit's P2 card from the connected device.

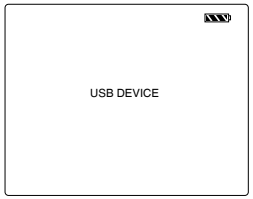

**THUMBNAİL / MODE**



Press and hold at least 2 seconds to return to the thumbnail display screen.

## Basic operations (continued)

### LCD monitor settings

**1** Hold down [POWER] for at least 1 second to turn the power on.

First check that an image is displayed on the LCD monitor, and then adjust the angle of the monitor to the position where it is easiest to see its displays.

**2** Press [THUMBNAIL/MODE] to display the normal display screen.

**3** Press [MENU/MODE CHK].

- Basic operations on the setting menus (Page 88)

**4** Using  $\nabla$ ,  $\triangle$ , and  $\square$ , select “CHANGE” for the “LCD SETTING” item on the setting menu “DISPLAY SETUP” screen.

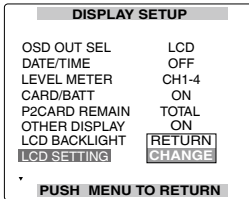

**5** Using  $\nabla$  and  $\triangle$ , select the item to be set.

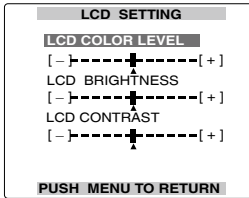

**LCD COLOR LEVEL:** This adjusts the color density of the screen.

**LCD BRIGHTNESS:** This adjusts the screen brightness.

**LCD CONTRAST:** This adjusts the screen contrast.

- Note that if you set all LCD adjustment values to minimum, the menu screen will become difficult to see.

**6** Using  $\triangleright$  or  $\triangleleft$ , adjust the selected item.

- When [RESET] is pressed, the adjusted values of the selected items can be restored to their factory settings.

**7** Press [MENU/MODE CHK] 3 times to return to the normal display screen.

## Setting date and time

The "CLOCK SETTING" value is recorded on the data content (clips), and it affects the sequence in which the thumbnails are played back. Before recording, be absolutely sure to check the "CLOCK SETTING" and "TIME ZONE" settings, and set them if necessary. Described below is the procedure for setting date and time to 5:20 PM on May 25, 2009.

**1** Hold down [POWER] for at least 1 second to turn the power on.

**2** Press [THUMBNAIL/MODE] to display the normal display screen.

**3** Press [MENU/MODE CHK].  
• Basic operations on the setting menus (Page 88)

**4** At the "TIME ZONE" item on the setting menu "OTHER FUNCTIONS", change the time difference from Greenwich Mean Time using  $\leftarrow$  and  $\rightarrow$ , and press  $\square$ . (Page 106)

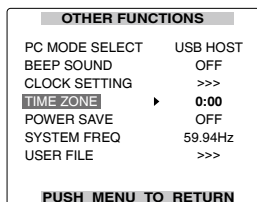

**5** Select "CHANGE" for the "CLOCK SETTING" item on the setting menu "OTHER FUNCTIONS" screen.

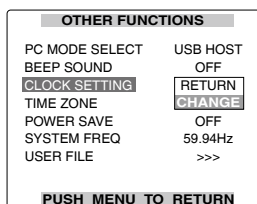

**6** Press  $\rightarrow$  or  $\leftarrow$  to set "YEAR" to "2009".

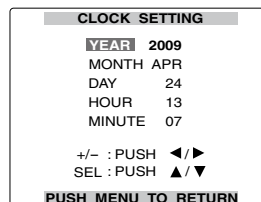

Any year from 2000 to 2037 can be set.

**7** Press  $\leftarrow$  to move the setting item to "MONTH".

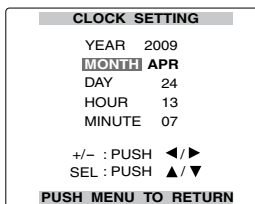

**8** Press  $\rightarrow$  or  $\leftarrow$  to set "MONTH" to "MAY".

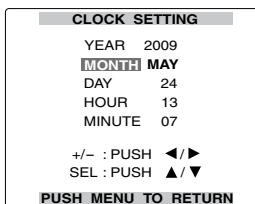

**9** Use the same method as in steps 7 and 8 to set "DAY", "HOUR" and "MINUTE".

- The 24-hour clock system is used by this unit.

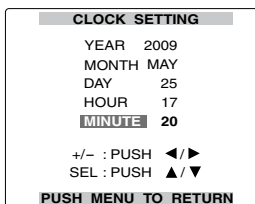

**10** Press [MENU/MODE CHK] 3 times to return to the normal display screen.

- There may be a time error. Check if the CLOCK shows the correct time before shooting.
- If the unit is going to be used overseas, do not set the "CLOCK SETTING" to the current time but input the time difference from GMT using the "TIME ZONE".

# P2 cards

## Inserting P2 cards

When the unit is to be used for the first time, the first step is always to set the internal clock. (Page 27)

**1** Hold down [POWER] for at least 1 second to turn the power on.

**2** Open the card slot cover, and insert the P2 card into the P2 card slot as far as it will go. Push further until the P2 card eject button pops out.

- When the P2 card is inserted into the unit, the P2 card status is displayed by the P2 card access LED.

For details on the P2 card status displayed, refer to “P2 card access LED and P2 card status” in the chart below.

**3** Tip the popped-out P2 card eject button to the right side and close the card slot cover.

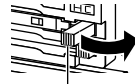
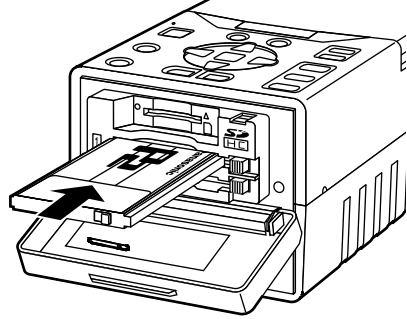

P2 card eject button

## P2 card access LED and P2 card status

### P2 card access LED

### P2 card status

<b>Lights up green</b>	Data can be saved on the card or loaded from the card.
<b>Lights up orange</b>	Data can be saved on the card or loaded from the card, and currently this card is supposed to be used for recording.
<b>Blinks in orange</b>	Data is now being saved or loaded.
<b>Blinks rapidly in orange</b>	The recognition process of the P2 card is underway.
<b>Blinks in green</b>	The P2 card is full. Data can be read out only.
	The write-protect switch on the P2 card is at the PROTECT setting. Data can be loaded only.
<b>Off</b>	The P2 card has not been formatted properly. Re-format the card using the unit.
	The card cannot be used by the unit. Replace the card.
	The P2 card is not installed.
	The P2 card is not being accessed in the USB DEVICE mode.

- The P2 card statuses can be checked in detail. Refer to “Displaying the P2 card status” on page 54.



## Formatting P2 cards

- 1** Hold down [POWER] for at least 1 second to turn the power on.  
The thumbnail screen now appears.
- 2** Press [MENU/MODE CHK].
- 3** Using  $\downarrow$ ,  $\uparrow$  and  $\square$ , select “OPERATION” – “FORMAT”, and press  $\square$ .
  - A screen such as the one shown below now appears. Select the number of the slot in which the P2 card to be formatted has been inserted. If the card is not going to be formatted, select “EXIT”.
  - If [MENU/MODE CHK] is pressed, the menu display is cleared.
- 4** Select “YES” on the confirmation screen, and press  $\square$ .
  - The selected P2 card is now formatted.
- 5** When the completion message has appeared, press “OK” ( $\square$ ).

If you format the P2 card, all the data saved on the P2 card is deleted.

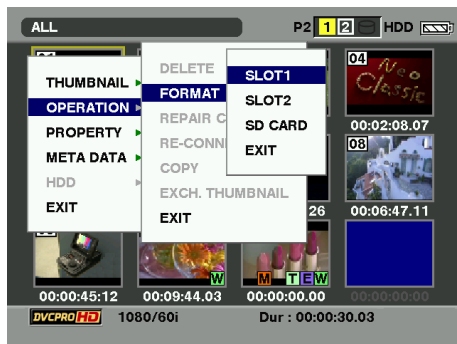

## P2 card protection

To prevent the data recorded on the P2 card from being deleted by mistake, set the write-protect switch on the P2 card to PROTECT.

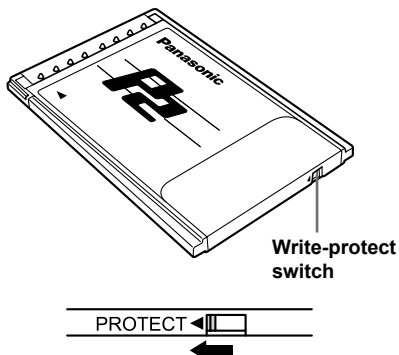

## P2 cards (continued)

### Ejecting P2 cards

**1** Confirm P2 card access LED is not blinking orange.

**2** Open the card slot cover and raise the P2 card eject button.



**3** Push the P2 card eject button to remove the P2 card.

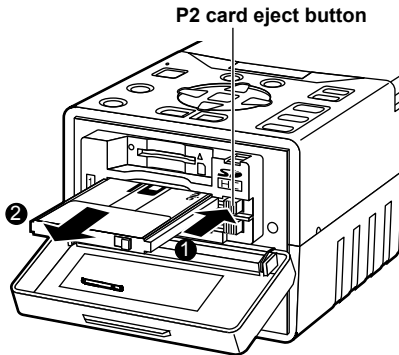

**4** After ejecting the P2 card, close the card slot cover.

- Do not eject cards or turn off the power in the following situations: otherwise, this may cause P2 card trouble.
  - 1) While the orange P2 card access LED is changing from blinking to lighting after the P2 card has been inserted
  - 2) During recording, during the process to complete recording or while the P2 card access LED is blinking
  - 3) While the P2 card access LED is blinking (i.e. while copying, formatting, etc.)

- In the event that a P2 card is ejected while being accessed or formatted, "TURN POWER OFF" is displayed on the LCD monitor. In a case like this, turn the power off and then turn it back on.

**When a card was ejected while it was being formatted:**

Re-format the card.

**When a card was ejected while its data was being accessed:**

Something may have gone wrong with one of the clips (Page 35). Check the clips, and repair the abnormal one. (For details on repairing clips → Page 41)

- During playback, a P2 card will not be recognized even if it has been inserted into the other empty slot, and the P2 card access LED will not light. After playback is completed, the P2 card recognition process is started.
- If the P2 card is ejected while thumbnails are displayed, the thumbnail display screen will be cleared and the normal display screen appears.

---

#### Precaution for using P2 cards

P2 cards must always be formatted using a P2 device prior to use.

---

## P2 card recording durations

Capacity	DVCPRO/DV Audio 2/4CH	DVCPRO50 Audio 4CH AVC-Intra50 Audio 8CH	DVCPRO HD AVC-Intra100 Audio 8CH *
4 GB	Approx. 16 minutes	Approx. 8 minutes	Approx. 4 minutes
8 GB	Approx. 32 minutes	Approx. 16 minutes	Approx. 8 minutes
16 GB	Approx. 64 minutes	Approx. 32 minutes	Approx. 16 minutes
32 GB	Approx. 128 minutes	Approx. 64 minutes	Approx. 32 minutes
64 GB	Approx. 256 minutes	Approx. 128 minutes	Approx. 64 minutes

\* Native recordings such as 720p/30pN, 720p/24pN, 720p/25pN, 1080/30pN, 1080/24pN and 1080/25pN are not available on this unit.

- **AJ-P2C002SG (2 GB) cards cannot be used.**
- The memory needed for management and other purposes is included in the memory figure displayed, so the amount of memory you can use for recording is less than what is displayed.
- The above chart shows continuous recording time for 1 clip in each capacity. Depending on the number of clips, available recording time on the whole may be shorter than the above time.
- Depending on the type of P2 card, you may need to update the driver installed in the unit. (Page 113)

## Dividing clips over 4 GB in size

### • Dividing clips recorded on P2 cards

If, when a P2 card with a memory capacity of 8 GB or more is used in this unit, the continuous recording time for a single session exceeds the time shown in the table below, the recording will automatically continue as another clip. Furthermore, when performing thumbnail operations (such as display, delete, repair or copy) for clips using the P2 device, these operations can be performed with all the clips treated as a single clip. The clips may be displayed as separate clips with non-linear editing software and PCs.

Recording format	Recording time
DVCPRO HD	Approx. 5 minutes
DVCPRO50	Approx. 10 minutes
DVCPRO/DV	Approx. 20 minutes
AVC-Intra100	Approx. 5 minutes
AVC-Intra50	Approx. 10 minutes

## P2 cards (continued)

### LOOP REC recording

With this function, when the recording buffer is full, the recording will loop back to the beginning and new contents will start overwriting the older contents of the buffer. Using LOOP REC, the recording will always consist of the most recent minutes recorded. The size of the recording buffer is determined by the amount of available space on both of the P2 cards. To use LOOP REC function, set "LOOP REC" to "ON" on the setting menu "RECORDING SETUP" screen. (Page 91)

- Once the unit is turned OFF, LOOP REC function will be disabled (OFF) next time the unit is turned ON.
- To perform LOOP REC, use P2 cards with remaining memory of 1 minute or more respectively.
- While performing LOOP REC, all P2 card access LEDs light orange. If you remove either of the P2 card, LOOP REC stops.
- When the LOOP REC mode is active, "LOOP" is displayed on the first line of the screen display. However, LOOP REC cannot be performed if only 1 card is inserted in the LOOP REC mode. In this case, "LACK" and "L-" blinks.
- The remaining time for the P2 card in the LOOP REC mode is approximate.
- Shot marks cannot be added or released during LOOP REC.
- Text memos cannot be recorded during LOOP REC.
- When selecting 1394 input, LOOP REC is not available.

#### ■ To exit the LOOP REC mode

There are following 2 ways.

- Set "LOOP REC" to OFF on the setting menu "RECORDING SETUP" screen.
- Turn off the power.

## Other

### USER button

The following features are allocated to the buttons at the time of shipping.

You can assign EXIT function to USER2 button only as well as ALT function to USER3 button only. For details, refer to the USER1-3 items (Page 97) on the setting menu "SW MODE" screen.

USER1: SYS FORMAT  
USER2: EXIT  
USER3: ALT

- The functions allocated to [USER] will be displayed while [MENU/MODE CHK] on the normal display screen is held down for at least 2 seconds.
- Depending on the mode, allocated functions may not be operable.

### Charging the internal battery

The date (year/month/day) and time are stored in the memory by the internal battery. When the  display has appeared on the LCD monitor screen, it means that the internal battery charge is low. Follow the steps below to charge the battery. After the battery has been fully charged, set Year/Month/Day and time.

**1 Connect the AC adapter to the unit.**  
Keep the unit's power turned off.

**2 Maintain this condition for about 4 hours.**  
The internal battery will now be charged.

If  appears even after the internal battery has been charged, the battery must be replaced. Ask your dealer for another battery.

# Using SD/SDHC memory cards

USER files can be saved or loaded using SD or SDHC memory cards (both types of cards will now be referred to as “SD cards”). (Page 34)  
 In addition, if you save a meta-data upload file on the SD card, it can be loaded and recorded as clip meta-data. (Page 46)

## Inserting and removing the SD card

<Insertion>

- 1 Open the card slot cover, and insert the card, making sure the SD card is oriented as shown.
- 2 Close the card slot cover.

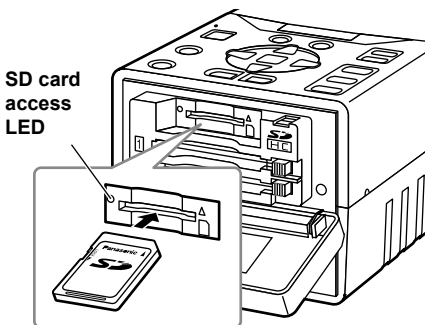

<Removal>

- 1 Open the card slot cover, and confirm that the SD card access LED is not lighted.
- 2 Push the center part of SD card and pull straight out.
- 3 Close the card slot cover.

## Formatting SD cards

- 1 Hold down [POWER] for at least 1 second to turn the power on.
- 2 Press [MENU/MODE CHK].
- 3 Using  $\nabla$ ,  $\triangle$  and  $\square$ , select “OPERATION” – “FORMAT” – “SD CARD”, and press  $\square$ .
  - If the card is not going to be formatted, select “EXIT”.

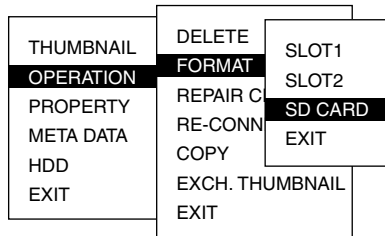

- 4 Select “YES” on the confirmation screen, and press  $\square$ .
  - The selected SD card is now formatted.
- 5 When the completion message has appeared, press “OK” ( $\square$ ).

- You can also format the SD card at the “SD CARD FORMAT” item on the setting menu “CARD FUNCTIONS” screen. (Page 105)
- With SDHC cards, 32 KB of memory will have already been used up.

## Precaution for using SD cards

With this unit, use SD cards which meet the SD standard or SDHC standard. Always remember to use this unit to format the SD cards. SD cards with the following memory sizes can be used within this unit.

### SD (8 MB to 2 GB):

8 MB	16 MB	32 MB	64 MB	128 MB
256 MB	512 MB	1 GB	2 GB	

### SDHC (4 GB to 32 GB):

4 GB	8 GB	16 GB	32 GB
------	------	-------	-------

To obtain the latest information which is not provided in these Operating Instructions, access the P2 support page on the web site below.  
<https://eww.pavc.panasonic.co.jp/pro-av/>

- When using the SD cards, always remember to close the card slot cover.
- Also refer to “Use of SD/SDHC memory cards” on page 116.

# Saving USER files on SD cards

Up to four sets of settings can be saved as four files on the SD card, and they can be loaded from the card.

- The menu setting value on the thumbnail display screen cannot be saved or loaded.

**1** Insert the SD card to the SD card slot.

**2** Press [THUMBNAIL/MODE] to display the normal display screen.

**3** Press [MENU/MODE CHK].

**4** Select “USER FILE” on the setting menu “CARD FUNCTIONS”, select “CHANGE”, and press [ENTER].

- Basic operations on the setting menus (Page 88)

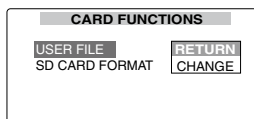

**5** Select “FILE SELECT”, and press [RIGHT].

**6** Using [UP] or [DOWN], select the file number (1 to 4), and press [ENTER].

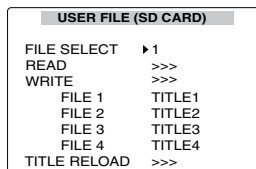

**7** Using [UP] and [DOWN], select “WRITE”, and press [ENTER].

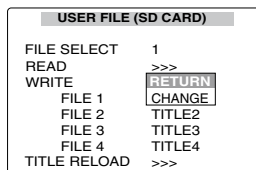

**8** Display “YES” using [LEFT] and [DOWN], and press [ENTER].

- In the figure below, “TITLE1” is the filename.
- After the data has been saved, “WRITE OK” is displayed.
- The USER file which was written changes to a white display.

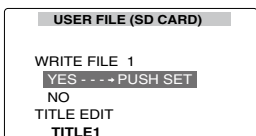

**9** Press [MENU/MODE CHK] four times to display the normal display screen.

**To give titles to files**

- 1) Perform steps 1 to 7.
- 2) Select the characters using [UP] and [DOWN], and move to the next character using [RIGHT].
  - The number of characters which can be input is 8.
  - Any of the following characters can be input. (Space), A to Z, 0 to 9, : ; < = > ? @ [ \ ] ^ \_ - . /
  - All the characters can be deleted using the unit's [RESET] button.
- 3) After all the characters have been input, press [LEFT] at the left end of the characters (or [RIGHT] at the right end), display “YES” using [DOWN], and press [ENTER].
  - After the data has been saved, “WRITE OK” is displayed.

**To load a file**

- 1) Perform steps 1 to 6.
- 2) Move to “READ” using [UP] and [DOWN], display “YES”, and press [ENTER].
  - The files are loaded.
- 3) If “TURN POWER OFF” appears after loading, turn off the power, and then turn it back on. The loaded files are now set.

**To reload the files from the SD card:**

- 1) Perform steps 1 to 4.
- 2) Using [UP] and [DOWN], move to “TITLE RELOAD”, display “YES”, and press [ENTER].
  - The files are now re-loaded.

- If “WRITE NG FORMAT ERROR” is displayed, format the SD card. (Page 33)
- If “WRITE NG WRITE PROTECT” is displayed, release the SD card protection.
- If “WRITE NG CANNOT ACCESS” is displayed, complete the other operations (such as playback), and then proceed to operate.
- If “WRITE NG ERROR” is displayed, the SD card may be defective. Replace the card.

# Thumbnail display

The video data produced on a P2 card by a single shooting session is referred to as a **clip**. When the unit's power is turned on, the clips are displayed as thumbnails on the LCD monitor. (If there are many clips, it will take a few moments for all the clips to be displayed)

## Playback formats

The formats which can be played back by this unit are as follows.

This unit cannot necessarily play back all the following formats simultaneously. Only the formats that support the setting menu "SYSTEM FREQ" can be actually played back.

### AVC-Intra100, AVC-Intra50

- 1080/60i
- 1080/50i
- 1080/30pN (native recording)\*
- 1080/24pN (native recording)\*
- 1080/25pN (native recording)
- 720/60p
- 720/30pN (native recording)\*
- 720/24pN (native recording)\*
- 720/50p
- 720/25pN (native recording)

### DVCPRO HD

- 1080/60i (30p over 60i, 24p over 60i, 24pA over 60i)\*
- 1080/50i (25p over 50i)
- 720/60p (30p over 60p, 24p over 60p)\*
- 720/30pN (native recording)\*
- 720/24pN (native recording)\*
- 720/50p (25p over 50p)
- 720/25pN (native recording)

### DVCPRO50/25, DV

- 480/60i (30p over 60i, 24p over 60i, 24pA over 60i)
- 576/50i (25p over 50i)

\* 24p, 30p, 60p and 60i operate with the actual frequencies of 23.98p, 29.97p, 59.94p and 59.94i respectively.

## Names and functions of thumbnail display screen parts

Menu configuration of thumbnail display screen (until the second hierarchy)

### THUMBNAIL

- ALL CLIP
- SAME FORMAT CLIPS
- SELECTED CLIPS
- MARKED CLIPS
- TEXT MEMO CLIPS
- SLOT CLIPS
- SETUP
- EXIT

### OPERATION

- DELETE
- FORMAT
- REPAIR CLIP
- RE-CONNECTION
- COPY
- EXCH. THUMBNAIL
- EXIT

### PROPERTY

- CLIP PROPERTY
- CARD STATUS
- DEVICES
- PROPERTY SETUP
- EXIT

### META DATA

- LOAD
- RECORD
- USER CLIP NAME
- INITIALIZE
- PROPERTY
- EXIT

### HDD

- EXPORT
- EXPLORE
- SETUP
- EXIT

(Continued on the next page)

# Thumbnail display (continued)

## Names and functions of thumbnail display screen parts (continued)

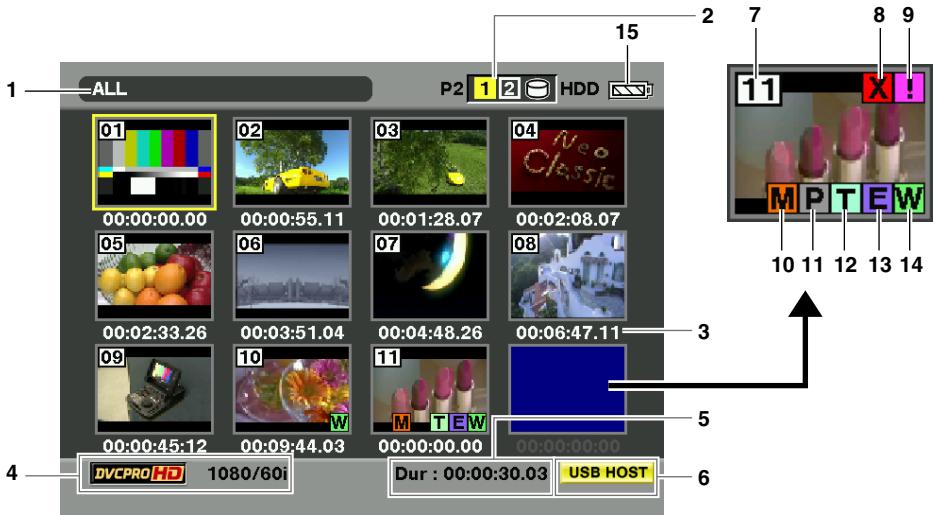

### 1 Display statuses

The types of information which are displayed on the screen are displayed as follows.

<b>ALL:</b>	All clips
<b>SAME FORMAT:</b>	Clip whose format is the same as the system format
<b>SELECT:</b>	Clip selected by the STILL/SET button
<b>MARKER:</b>	Clip to which the shot mark has been added
<b>TEXT MEMO:</b>	Clip with text memo data
<b>SLOT n:</b>	Clip on the P2 card in slot "n"
<b>PROPERTY:</b>	Detailed clip information
<b>P2/REMAIN:</b>	Media information (remaining memory)
<b>P2/USED:</b>	Media information (used memory)
<b>META DATA:</b>	meta-data set on this unit

When you select SDI on the setting menu "INPUT SELECT" and input a signal into SDI input connector, input the same signal as the one set on the setting menu "SYS FORMAT". If you input a signal with the different format, the thumbnail display will be distorted also.

### 2 P2 card slot numbers and hard drive statuses

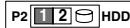

#### • P2 card





<b>1 2</b> (Gray)	The numbers of the P2 card slots where P2 cards have not been inserted are displayed in gray.
<b>1 2</b> * (White)	The numbers of the P2 card slots where P2 cards have been inserted are displayed in white.
<b>1 2</b> * (Yellow)	The number of the P2 card slot, which contains a P2 card with a clip that has its cursor position recorded, is displayed in yellow. When a single clip has been recorded on a multiple number of P2 cards, all the slot numbers of the cards on which the clip is recorded will be displayed in yellow.

\* The frame is displayed in pink when the inserted P2 card is in one of the following statuses:

- RUN DOWN CARD (Page 84)  
The maximum number of overwrites on the P2 card has been exceeded.
- DIR ENTRY NG CARD (Page 83)  
The directory structure on the P2 card is not supported.



• **HDD**

 (Gray)	When a mode other than the USB HOST mode is established or when the USB HOST mode is established but the hard drive is not connected, this status is displayed in gray.
 (White)	When the USB HOST mode is established and the hard drive that can be used is connected, this status is displayed in white.
 (Yellow)	When the USB HOST mode is established and the clips on the hard drive are displayed as thumbnails, this status is displayed in yellow.
 (Red)	When the USB HOST mode is established and the hard drive is not in the data copy enable status, this status is displayed in red.

**3 Clip information display**

Depending on what has been set on the thumbnail display screen (Page 39), the time code at the clip recording start point or the user's bit, shooting time, shooting date, shooting date/time, USER CLIP NAME or SLOT number is displayed.

**4 Clip format**

The compression format, video recording format and frame rate of the clip where the cursor is positioned is displayed.

**5 Duration**

The length of the clip where the cursor is positioned is displayed.

**6 USB HOST mode indicator**



This appears when the USB HOST mode has been selected.

**7 Clip number**

These are the numbers which have been set by the unit for all the correctly recognized clips on a P2 card. The numbers are allocated in sequence starting from the earliest shooting date/time. The clips which cannot be played back are displayed in red.

**8  Defective clip indicator**

** Unknown clip indicator**

This indicates clips whose recording contains problems for reasons such as the power being cut off while they were being recorded. It may be possible to repair clips which are indicated by the yellow defective clip indicator. For further details, refer to "Repairing defective clips" (Page 41). It is not possible to repair clips which are indicated by the red defective clip indicator so delete them. If these clips cannot be deleted, format the P2 card. In the case of formats incompatible with this unit,  is displayed instead of .

**9  Incomplete clip indicator**

This appears when a single clip has been recorded onto a multiple number of P2 cards and one of the P2 cards concerned has not been inserted into the P2 card slot.

**10  Shot mark indicator**

This is indicated on the clips of which a shot mark has been added to their thumbnails.

**11  Clip-with-proxy indicator**

This indicates clips for which a proxy has been additionally recorded.

**12  Text memo indicator**

This indicates clips with text memo data.





**13  Edit-copy clip indicator**



This indicates clips which have been edit-copied by the AJ-HPM110 or other model which supports the edit-copy function. For details on the edit-copy function, refer to the operating instructions of the model which supports the function.

**14  Wide indicator**

This indicates clips which have been recorded using the 16:9 aspect ratio. It does not indicate clips which were formatted by a hard drive.

**15  Remaining battery charge display**

As the remaining charge drops, the display changes in the following sequence:  →  →  → and .

When the charge is virtually depleted, the  (or ) display changes to red.

(While the AC adapter is being used, a display other than  may appear: this is normal and not a sign of trouble)

## Thumbnail display (continued)

### Changing the displays on the thumbnail display screen

You can customize the thumbnail display screen to better suit your operating needs for more efficient operation.

- 1 Display the thumbnail display screen.
- 2 Press [MENU/MODE CHK].
- 3 Using  $\nabla$ ,  $\triangle$  and  $\square$ , select the type of clip to be displayed at the lower level of "THUMBNAIL", and press  $\square$ .



<b>ALL CLIP:</b>	Select this to display all the clips.
<b>SAME FORMAT CLIPS:</b>	Select this to display the clips whose format is the same as the system format.
<b>SELECTED CLIPS:</b>	Select this to display the clips selected by the STILL/SET button.
<b>MARKED CLIPS:</b>	Select this to display the clips to which shot marks have been added.
<b>TEXT MEMO CLIPS:</b>	Select this to display the clips with text memo data.
<b>SLOT CLIPS:</b>	Select this to display the clips on the P2 card of slot number "n".
<b>SETUP:</b>	This enables you to change the display of the thumbnail indicators, data displays and other settings.
<b>EXIT:</b>	Select this to return to the previous menu.

## Setting the items to be displayed

You can customize how the thumbnails are to be displayed to better suit your intended application. This enables you to change the display of the thumbnail indicators, data displays and other settings.

- 1 Display the thumbnail display screen.
- 2 Press [MENU/MODE CHK].
- 3 Using  $\nabla$ ,  $\triangle$  and  $\square$ , select the item to be set at the lower level of "THUMBNAIL"  
– "SETUP", and press  $\square$ .

<b>INDICATOR:</b>	This menu item enables you to set the indicator on the thumbnail to be displayed/not displayed.
<u>ALL HIDE</u>	If selected, none of the indicators are displayed. If not selected, the indicators are displayed in line with the settings of the menu items below.
<u>MARKER</u>	Shot mark indicator
<u>TEXT MEMO</u>	Text memo indicator
<u>WIDE</u>	Wide indicator
<u>PROXY</u>	Proxy indicator
<b>DATA DISPLAY:</b>	This menu item enables you to select what is to be displayed in the clip information display (Page 37).
<u>TC</u>	Time code
<u>UB</u>	User's bit
<u>TIME</u>	Time of recording
<u>DATE</u>	Date of recording
<u>DATE TIME</u>	Date/time of recording
<u>USER CLIP NAME</u>	Up to 15 characters from the beginning of the user clip name are displayed. (When displayed in English)
<u>SLOT</u>	Slot number

<b>DATE FORMAT:</b>	This menu enables you to select the display format for recording date.
<u>Y-M-D</u>	Year/month/day
<u>M-D-Y</u>	Month/day/year
<u>D-M-Y</u>	Day/month/year
	<ul style="list-style-type: none"> <li>This setting will also be reflected in the preparation dates of the file displays such as the dates of the recordings which are displayed as one of the clip properties, the dates of the recordings which are displayed when DATE has been selected as the DATA DISPLAY item setting, and the loading dates of the meta-data.</li> </ul>
<b>THUMBNAIL SIZE:</b>	This menu item enables you to select the size of the thumbnails which will be displayed on screen.
<u>LARGE</u>	Large size (The thumbnail is displayed with width 3 x length 2)
<u>NORMAL</u>	Standard size (The thumbnail is displayed with width 4 x length 3)
<b>PLAYBACK RESUME:</b>	When the cursor was not moved from the clip where playback was stopped, the next playback starts from that stopped position.
<u>ON</u>	Select "ON" to play back from the stop position.
<u>OFF</u>	Select "OFF" to play back the clip from its beginning.
<b>THUMBNAIL INIT:</b>	This menu item enables you to return the thumbnail display settings to the factory settings.
<b>SORT:</b>	This menu item enables you to set the order of clip display in the thumbnail display.
<u>OFF</u>	Normal
<u>SLOT</u>	Sort the order of display by the slot number
<b>EXIT:</b>	Select this to return to the previous menu.

\_\_\_ The underlined settings are the factory mode settings.

# Clip management

## Selecting clips

When performing operations on the thumbnail display screen, select the clip which will be the target of these operations as follows.

### 1 Using $\Delta$ , $\nabla$ , $\triangleright$ or $\triangleleft$ , move the cursor (yellow frame) to the target clip.

To move the cursor to left or right, use  $\triangleright$  or  $\triangleleft$ .

You can also use  $\triangleright$  or  $\triangleleft$  by pressing and holding [ALT/3].

To move the cursor up and down, use  $\Delta$  or  $\nabla$  by pressing and holding [ALT/3].

This operation on the rest of the pages in this manual is referred to as “cross cursor operation”.

### 2 Press $\square$ .

A bluish-green frame now appears at the clip where the cursor is positioned to indicate that the clip has been selected.



- To allocate functions to the USER buttons, refer to “USER button” (Page 32).
- [ALT/3] does not work when ALT function is not allocated to [ALT/3].
- By repeating steps 1 and 2, you can select a multiple number of clips.
- If you select a clip and move the cursor to another clip, and then press  $\square$  while pressing and holding [ALT/3], you can select from the last selected clip until the clip at the cursor position at a time.
- To move from one page to another, press  $\square$  or  $\triangleright$  of 

## To release the selection

### 1 Move the cursor to the selected clip, and press $\square$ again.

The selection is released.

- By pressing [EXIT/2] while pressing [ALT/3], you can cancel the selection of the selected clips all together.

## Deleting clips

You can delete unwanted clips from the P2 card by proceeding as follows.

### 1 Display the thumbnail display screen.

### 2 Select the clips to be deleted.



### 3 Press [MENU/MODE CHK].

### 4 Using $\nabla$ , $\Delta$ and $\square$ , select “OPERATION” – “DELETE”, and press $\square$ .

### 5 Select “YES”, and press $\square$ .

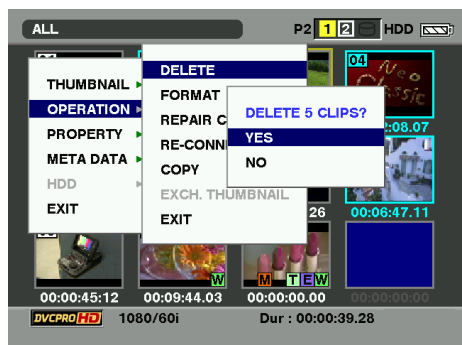
### 6 When the completion message has appeared, press “OK” ( $\square$ ).



- It may not be possible to delete clips for which the  defective clip indicator or  unknown clip indicator is displayed.





---

---

## Repairing and connecting clips

### Repairing defective clips





The defective clip indicator (yellow ) appears in order to indicate that there is a problem in the clip such as the power having been suddenly cut off while it was being recorded. You can repair problem clips by proceeding as follows.

- 1** Display the thumbnail display screen.
- 2** Select the clip to be repaired.
- 3** Press [MENU/MODE CHK].
- 4** Using ,  and , select "OPERATION"  
– "REPAIR CLIP", and press .
- 5** Select "YES", and press .

- 
- 
- It is not possible to repair clips with some types of damage. These kinds of clips are identified by the red .
- 
- 

### Connecting incomplete clips

In some cases, clips recorded on a multiple number of P2 cards may not be recognized as a single continuous clip and may be recognized as an incomplete clip () instead. At times like this you can use the connecting function to restore the "incomplete" clip to a continuous (originally connected) clip.

- 1** Display the thumbnail display screen.
- 2** Select the incomplete clip to be connected.
- 3** Press [MENU/MODE CHK].
- 4** Using ,  and , select "OPERATION"  
– "RE-CONNECTION", and press .
- 5** Select "YES", and press .

---

---

A clip is recognized as incomplete when:

- A clip recorded on a multiple number of P2 cards has been copied separately from one card and then from another or other cards.
  - A clip recorded on a multiple number of cards has first been copied separately from one card and then from another or other cards onto a hard drive and then written back onto the P2 cards.
  - A long clip lasting more than 5 minutes in the AVC-Intra100 or DVCPRO HD format (10 or so minutes in the AVC-Intra50 or DVCPRO50 format, or 20 or so minutes in the DVCPRO or DV format) has first been copied to a hard drive and then written back onto the P2 cards.
- 
- 

- Normally, thumbnails with the incomplete clip indicator are displayed side by side.
  - If only parts of incomplete clips separated into 3 or more have been connected, the incomplete clip indicators will remain on the screen until all the clips which make up the original clip are connected.
- 
-

# Clip management (continued)

## Copying clips

Clips can be copied onto the P2 card in the other P2 card slot.

- While clips are being copied, do not turn off the power or eject the card. Otherwise, defective clips will be produced. If defective clips are produced, delete them, and copy the original clips again.
- Copy incomplete clips after having connected them.

**1** Display the thumbnail display screen.

**2** Select the clip to be copied.

**3** Press [MENU/MODE CHK].

**4** Using  $\nabla$ ,  $\triangle$  and  $\square$ , select “OPERATION” – “COPY” – “SLOT n” (where “n” is the number of the P2 card slot into which the copy destination P2 card was inserted), and press  $\square$ .

**5** Select “YES”, and press  $\square$ .  
Clip copying now starts.

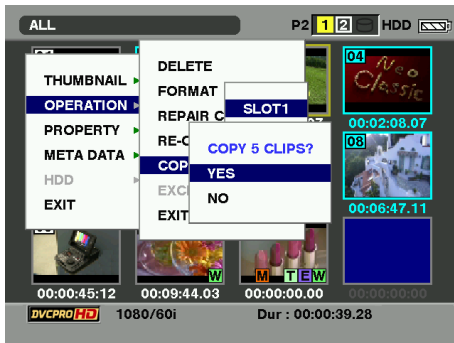

- To stop the copying process at any time, press  $\square$  and select [YES] to cancel the copying. The partially copied clip at the copy destination will be deleted.
- If there is a clip with the same GLOBAL CLIP ID--one which, for instance, was previously copied to the copy destination--“OVER WRITE” will appear. To overwrite the existing clip, select “YES” or to cancel the overwriting, select “NO”, and press  $\square$ . (When you copy some portion of a clip which has been recorded on a multiple number of P2 cards, “OVER WRITE” also appears when copying the remaining portion of the clip.)

**6** When the completion message has appeared, press “OK” ( $\square$ ).

Clips cannot be copied when any of the following error messages are displayed.

- “LACK OF REC CAPACITY!”  
Clips will not be copied because there is not enough space left on the destination P2 card.
- “UNKNOWN CONTENTS FORMAT!”  
Clips will not be copied because the selected clips include defective clips.
- “NO COPY TO SAME CARD!”  
Clips will not be copied because an attempt is being made to copy clips to the same card.
- “TOO MANY CLIPS!”  
Clips will not be copied because too many clips have been selected.
- You can extract and copy a portion or subset of a clip. If you start copying while selecting a text memo at the bottom of the text memo screen, the block between the selected text memo position and the next text memo is copied. If there is no text memo after the selected text memo, the block from the text memo position to the end of the clip will be copied.

- Clips displayed by the  $\times$  defective clip indicator cannot be copied.
- It may not be possible to copy clips for which the  $\square$  unknown clip indicator is displayed.

## Displaying the clip information

You can display detailed information about clips on the screen, and check it.

- 1 Display the thumbnail display screen.
- 2 With cross cursor operation, move the cursor to the target clip.
- 3 Press [MENU/MODE CHK].
- 4 Using  $\downarrow$  and  $\uparrow$ , select "PROPERTY", and press  $\square$ .
- 5 Select "CLIP PROPERTY" on the sub-menu displayed, and press  $\square$ .



Information on the target clip now appears on the screen.

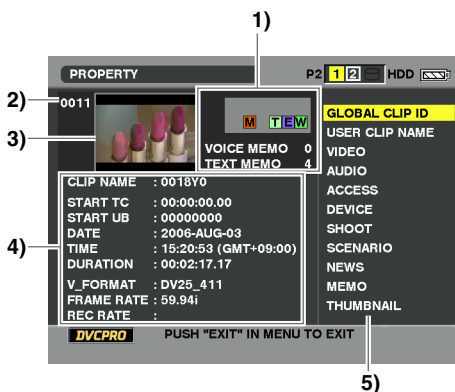

### 1) Information added to clips (Page 37)

The indicators or numbers of text memos or voice memos, which have been added into clips, are displayed. In addition, when a P2 card on which clips have been recorded has been write-protected, the  $\square$  mark is displayed.

#### • $\square$ Voice memo indicator

This is displayed on clips to which voice memos have been added. It appears only in the clip property mode.

- Voice memos cannot be recorded or played back using this unit.

### 2) Clip number

### 3) Thumbnail

### 4) Clip information

The following information is displayed.

<b>CLIP NAME:</b>	The filename of the clip as recorded on the P2 card
<b>START TC:</b>	Time code when recording was started
<b>START UB:</b>	User's bit when recording was started
<b>DATE:</b>	Date on which the clip was recorded
<b>TIME:</b>	Time at which the clip was recorded
<b>DURATION:</b>	Length of the clip
<b>V_FORMAT:</b>	Recording format of the clip
<b>FRAME RATE:</b>	Playback frame rate
<b>REC RATE:</b>	Recording frame rate (displayed for clips specially recorded by the camera recorder (i.e. VFR recording))

When  $\leftarrow$  or  $\rightarrow$  is pressed, the information of the previous or next clip is displayed.

### 5) Clip meta-data

Items for referencing the detailed information on the clips (clip meta-data) are displayed.

(Continued on the next page)

## Clip management (continued)

### Displaying the clip information (continued)

#### 6 If necessary, reference the clip meta-data contents.

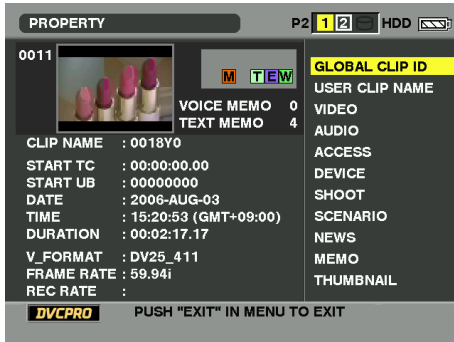

When the clip meta-data item is selected using  $\nabla$  and  $\triangle$ , and then  $\square$  is pressed, the following information is displayed.

<b>GLOBAL CLIP ID:</b>	A unique number which is not assigned to any other clips
<b>USER CLIP NAME:</b>	Clip name which can be assigned by the user Normally, the GLOBAL CLIP ID is provided as the clip name.
<b>VIDEO:</b>	Video signal system, etc. (frame rate, pull-down, aspect ratio)
<b>AUDIO:</b>	Audio channel system, etc. (sampling rate, bit rate)
<b>ACCESS:</b>	Last update date, etc. (name of the person who created the clip and date on which it was created, date on which the clip was last updated and name of the person who last updated the clip)
<b>DEVICE:</b>	Serial number of device used to record the clip, etc. (name of the device manufacturer, serial number, model number)
<b>SHOOT:</b>	Recording start and end dates, etc. (name of person who shot the clip, date on which shooting started, date on which shooting ended, shooting location information, altitude, longitude, latitude, shooting location information source, shooting location)
<b>SCENARIO:</b>	Program name, scene number, etc. (program name, scene number, take number)

**NEWS:** Reporter, news-gathering object, etc. (reporter, purpose of news gathering, object of news gathering)

**MEMO:** Text memo number, recording position, name, text content

- The recording position is indicated by the number of frames from the beginning. On a thumbnail text memo display, this recording position is indicated as a time code instead.
- Texts consisting of up to 1000 characters can be attached, but only the first 100 characters will actually be displayed.
- $\leftarrow$  or  $\rightarrow$  is used to move from one text memo number to another.

**THUMBNAIL:** Information on the thumbnail images  
The frame positions and sizes (offset value from the beginning of the clip, height and width) of the thumbnail source images are displayed.

#### 7 Press [MENU/MODE CHK], and select "EXIT" to exit.



## Editing the clip information

You can edit the detailed clip information (clip meta-data).

- 1 Display the thumbnail display screen.
- 2 With cross cursor operation, move the cursor to the target clip.
- 3 Press [MENU/MODE CHK].
- 4 Using  $\nabla$ ,  $\triangle$  and  $\square$ , select “PROPERTY” – “CLIP PROPERTY”, and press  $\square$ .
  - The clip information is displayed.
- 5 Using  $\nabla$  and  $\triangle$ , select the item to be edited, and press  $\square$ .
- 6 The window with the items to be edited now appears so select an item using  $\nabla$  and  $\triangle$ , and then press  $\square$ .
- 7 The soft keyboard screen now appears. With cross cursor operation, select characters to be input, and while entering them using  $\square$ , edit the information.
- 8 Select “OK” with cross cursor operation, and press  $\square$  to quit editing.
  - To edit another item, repeat steps 6 to 8.
- 9 Using  $\nabla$  and  $\triangle$ , select “OK” to exit the item display.
- 10 Press [MENU/MODE CHK], and select “EXIT” to exit the clip information screen.

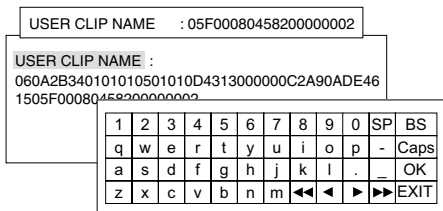

You can edit the following information.

USER CLIP NAME	This displays the name of the clip which has been set by the user; the global clip ID is set as the default value.		
ACCESS	CREATOR	Name of the person who did the recording	
SHOOT	SHOOTER	Name of the person who did the shooting	
	LOCATION	ALTITUDE	Altitude of the shooting location
		LONGITUDE	Longitude of the shooting location
		LATITUDE	Latitude of the shooting location
SCENARIO	PLACE NAME	Place name	
	PROGRAM NAME	Program name	
	SCENE NO.	Scene number	
NEWS	TAKE NO.	Take number	
	REPORTER	Name of the reporter	
	PURPOSE	Purpose of the news gathering	
MEMO	OBJECT	Object of the news gathering	
	PERSON	Name of the person who recorded the text memo which was added to the clip	
	TEXT	Content of the text memo	

- “LONGITUDE” and “LATITUDE” cannot be deleted separately. To delete, set “ALTITUDE” to blank.
- To modify the meta-data of clips displayed by the incomplete clip indicator  $\square$ , insert the P2 card on which the remaining clips were recorded.
- Attached memo items of 100 characters or more cannot be modified.
- When editing “LONGITUDE” or “LATITUDE”,  $\blacktriangleright$  or  $\blacktriangleleft$  is sometimes used to move to the item.

## Clip management (continued)

---

### Adding the meta-data to clips

If the meta-data upload file which contains the name of shooter or reporter, shooting location or text memo information is saved on the SD card, it can be loaded and recorded as clip meta-data.

Create the meta-data upload file on a PC



Save it on a SD card



Load the meta-data upload file onto this unit



When images are recorded, the meta-data is added to the clip.

### Preparation of the meta-data upload file

You can create the meta-data upload file on a PC using the P2 viewer (the latest updated version). You can also create meta-data upload files using the P2 Contents Management System (P2CMS) software, on either a Windows or Macintosh computer.

The P2 viewer is an application to operate clips recorded on the P2 card. Distributed as free software, this is used on a Windows PC.

<https://eww.pavc.panasonic.co.jp/pro-av/>

Install the P2 viewer or P2 Contents Management System (P2CMS) software (the latest updated version) to PC, create the meta-data upload file and write it onto the SD card.

- 
- P2 viewer must be the latest updated version.  
For details on creating the meta-data upload file, refer to Help section of the P2 viewer.  
For SD cards, refer to page 33.
-

## Setting to add meta-data

Make the setting to load the meta-data upload file onto this unit

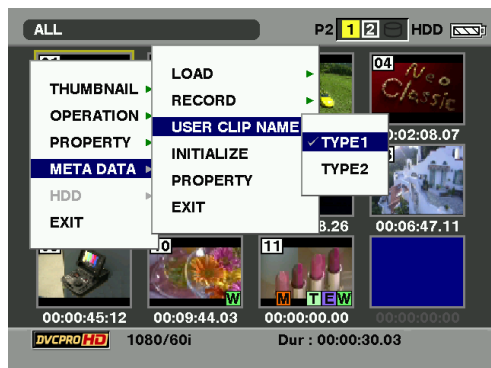

- **Select the method to record USER CLIP NAME**  
Set the recording method of USER CLIP NAME.

- 1** Display the thumbnail display screen.
- 2** Press [MENU/MODE CHK].
- 3** With cross cursor operation, move the cursor to “META DATA”–“USER CLIP NAME”.
- 4** Move the cursor to “TYPE1” or “TYPE2” and press [ENTER].

Recording method	USER CLIP NAME to be recorded	
Use clip meta-data	TYPE1	Loaded meta-data setting value
	TYPE2	Loaded meta-data setting value + COUNT value
Not use clip meta-data*	TYPE1	The same as GLOBAL CLIP ID
	TYPE2	The same as CLIP NAME

\* When the meta-data upload file has been loaded, but “META DATA”–“RECORD” is “OFF”

- 5** Press [MENU/MODE CHK] to end the procedure.

(Continued on the next page)

## Clip management (continued)

### Adding the meta-data to clips (continued)

#### COUNT value

COUNT value is displayed in 4-digit number. COUNT value is added by 1 increment every time a new clip is generated by P2 card recording after the recording method of “USER CLIP NAME” is set to “TYPE2” and the clip meta-data is loaded.

#### ■ Resetting the COUNT value

You can reset the COUNT value according to the following operation.

- 1 Display the thumbnail display screen.
- 2 Press [MENU/MODE CHK].
- 3 With cross cursor operation, move the cursor to “META DATA”–“PROPERTY”–“USER CLIP NAME” and press .

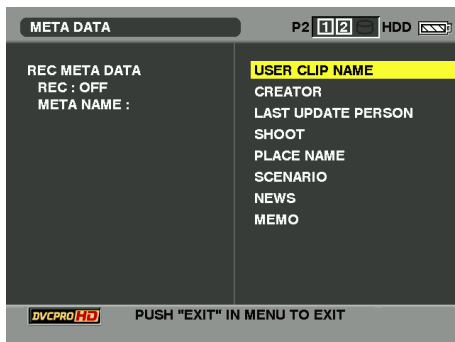

- 
- 4** With cross cursor operation, move the cursor to “COUNT RESET” and press **[↵]**.  
The COUNT value is reset to 1.

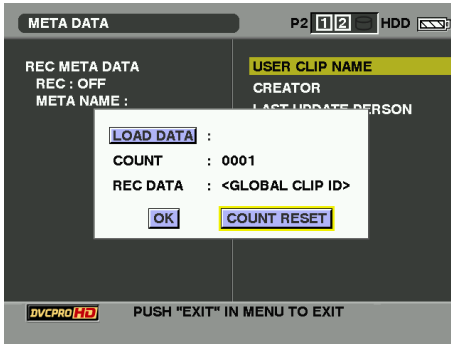

- 5** Press **[MENU/MODE CHK]** or **[EXIT/2]** to end the procedure.

(Continued on the next page)

## Clip management (continued)

### Adding the meta-data to clips (continued)

#### How the COUNT value of USER CLIP NAME is added when the data exceeds 4 GB

In the following cases, 1 shot is recorded as multiple clips and the COUNT value is added by 1 increment and recorded.

- When a P2 card with the capacity of over 8 GB is used and the continuous recording at a time exceeds a certain period of time

For further details, refer to “Dividing clips over 4 GB in size” (Page 31).

- When 1 recording straddles 2 cards and is recorded on both cards

Furthermore, when performing thumbnail display and property display using the P2 device, Clip 1's thumbnail and COUNT value are displayed.

### Loading the meta-data setting value

You can load the meta-data setting value from the SD card according to the following operation.

- 1** Insert the SD card containing the meta-data upload file into this unit.
- 2** Display the thumbnail display screen.
- 3** Press [MENU/MODE CHK].
- 4** With cross cursor operation, move the cursor to “META DATA”–“LOAD” and press  $\square$ .  
The file name of the meta-data upload file in the SD card is displayed.

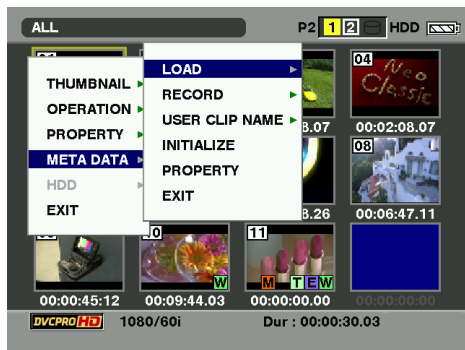

- 5** With cross cursor operation, move the cursor to the file to be loaded and press  $\square$ .
- 6** Move the cursor to “YES” and press  $\square$ .  
The meta-data is loaded.
- 7** Press [MENU/MODE CHK] to end the procedure.

## Checking and revising the loaded meta-data

You can check and revise the meta-data loaded from the SD card.

### 1 Press [THUMBNAIL/MODE].

The thumbnail screen appears on the LCD monitor.

### 2 Press [MENU/MODE CHK] to select "META DATA"-"PROPERTY" from the thumbnail menu.

The following screen appears.

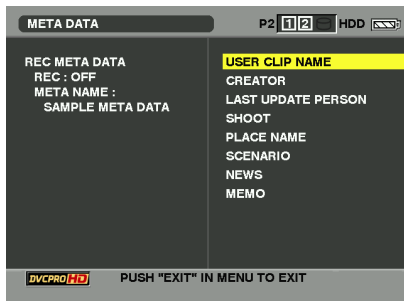

### 3 With cross cursor operation, move the cursor and press [M].

You can check each setting content of the loaded meta-data.

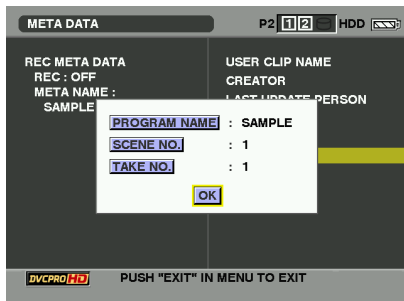

### 4 While checking each setting content of the meta-data, move the cursor with cross cursor operation to the item for which you wish to change the setting content and press [M].

The soft keyboard screen appears. Now, you can change the setting. (Page 45)

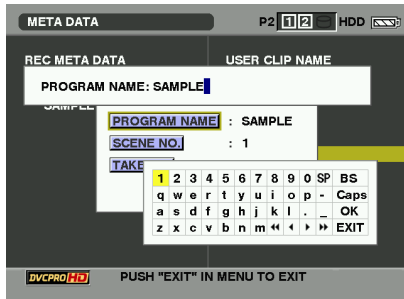

(Continued on the next page)

## Clip management (continued)

### Adding the meta-data to clips (continued)

### Checking and revising the loaded meta-data (continued)

With cross cursor operation, move the cursor to the item of meta-data you wish to check and press  $\square$ . Then the information is displayed.

<b>USER CLIP NAME:</b>	User clip name
<b>CREATOR:</b>	Creator
<b>LAST UPDATE PERSON:</b>	Last update person
<b>SHOOT:</b>	Shooter
<b>PLACE NAME:</b>	Shooting place
<b>SCENARIO:</b>	Program name, scene number, take number
<b>NEWS:</b>	Reporter, purpose of news gathering, object of news gathering
<b>MEMO:</b>	Memo input person, text information

- After checking the content, press [EXIT/2] or  $\square$ . The information screen disappears.
- To finish the setting change procedure, select "OK"

**5** Press [MENU/MODE CHK] to end the procedure.

### Deleting the meta-data

You can delete the meta-data saved in this unit according to the following operation.

**1** Display the thumbnail display screen.

**2** Press [MENU/MODE CHK].

**3** With cross cursor operation, move the cursor to "META DATA"—"INITIALIZE" and press  $\square$ .

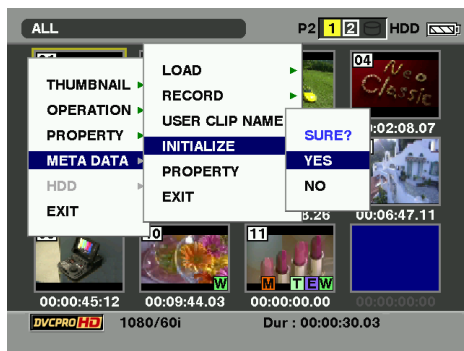

**4** Move the cursor to "YES" on the confirmation screen and press  $\square$ . The meta-data will be deleted.

**5** Press [MENU/MODE CHK] to end the procedure.



---

---

## Recording clips to which the meta-data was added

You can add the loaded meta-data to clips when recording clips.

- 1 Display the thumbnail display screen.
- 2 Press [MENU/MODE CHK].
- 3 With cross cursor operation, move the cursor to “META DATA”–“RECORD”.

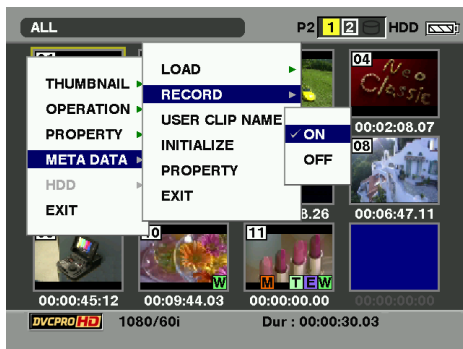

- 4 Move the cursor to “ON” and press [ENTER].

With this setting, you can record video and the loaded meta-data at the same time. USER CLIP NAME is added as meta-data according to the set recording method.

- 5 Press [MENU/MODE CHK] to end the procedure.
- 6 Recording video on this unit.

- 
- 
- If you set “OFF” in step 4, meta-data is not added to the clip.
- 
-

# Clip management (continued)

## Adding shot marks to clips

You can differentiate one clip from all the other clips by adding shot marks.

- 1 Display the thumbnail display screen.
- 2 With cross cursor operation, move the cursor to the target clip.
- 3 Press [USER] in which the shot mark function was allocated. (Page 32)

To release a shot mark, repeat the above steps.

If the video data created by a shooting session consists of a multiple number of clips, it will not be possible to add or release the shot marks unless all the P2 cards containing the video data are inserted into the slots.

- Shot marks cannot be added into the clips on a card whose write protect switch is at the PROTECT position.
- Shot marks can be added during recording as well. (Page 63)
- Shot marks cannot be added or released during playback.
- Shot marks cannot be added or released during LOOP REC.

## Displaying the P2 card status

The statuses of the P2 card slots, operation statuses of the P2 cards and other card information can be displayed on the screen, and checked.

- 1 Display the thumbnail display screen.
- 2 Press [MENU/MODE CHK].
- 3 Using  $\downarrow$ ,  $\uparrow$  and  $\square$ , select "PROPERTY" – "PROPERTY SETUP" – "P2 CARD CAP", and press  $\square$ .
- 4 Use  $\downarrow$  and  $\uparrow$  to select the item to be set, and press  $\square$ .

REMAIN: Remaining memory display  
(default value)

USED: Used memory display

- 5 Press  $\leftarrow$ .
- 6 Using  $\downarrow$  and  $\uparrow$ , select "CARD STATUS", and press  $\square$ .

[When REMAIN has been selected]

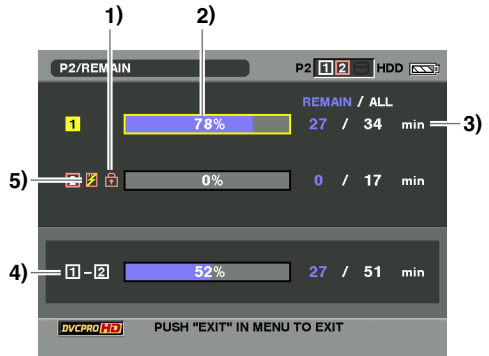

[When USED has been selected]

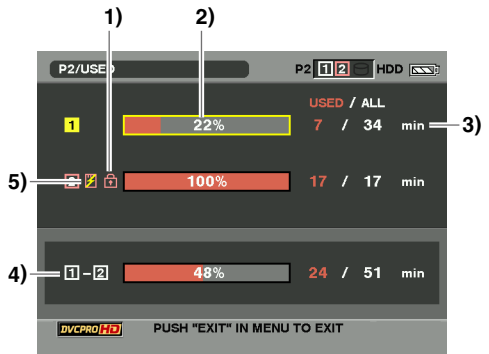

**1) Write-protect mark**



The  mark is displayed when a P2 card is write-protected.

**2) P2 card status**

With the remaining memory display, the P2 card's remaining memory is indicated using a meter and as a percentage. With the used memory display, the P2 card's used memory is indicated using a meter and as a percentage. Depending on the status of the card, one of the following messages may be displayed.

<b>FORMAT ERROR:</b>	An unformatted P2 card has been inserted.
<b>NOT SUPPORTED:</b>	A card which is not supported by the unit has been inserted.
<b>NO CARD:</b>	A P2 card has not been inserted.

**P2 card details display**

When the cursor is moved to the slot whose P2 card status is displayed and  is pressed, the model number of the P2 card and other detailed information on the card will be displayed. When  is pressed again, the detailed information is cleared.

The card details are displayed as follows.

BRAND	: Panasonic
MODEL NO.	: AJ-P2C032RG
SERIAL NO.	: AAF07L0520
USER ID	:
	

**3) P2 card remaining memory (or used memory) and total memory**

A figure representing the remaining memory (or used memory) of P2 cards/total memory is displayed in minute equivalent. Fractions of a minute are discarded so that the total of the remaining memory (or used memory) on each P2 card may not exactly correspond to the total memory.

**4) Slot remaining memory (or used memory) total**

A figure representing the total for the remaining memory (or used memory) of the cards in the two P2 card slots is displayed.

- The free memory of a write-protected P2 card is not included in the remaining memory.

**5) P2 card warning displays**

 is displayed when the P2 card is in one of the following statuses:

Details of the warnings can be checked on the P2 card details display.

- **RUN DOWN CARD:**  
The maximum number of overwrites on the P2 card has been exceeded.
- **DIR ENTRY NG:**  
The directory structure on the P2 card is not supported.

# Clip management (continued)

## Displaying SD card information

You can display the usage statuses of SD cards on the screen, and check them.

- 1 Display the thumbnail display screen.
- 2 Press [MENU/MODE CHK].
- 3 Using  $\nabla$ ,  $\triangle$  and  $\square$ , select “PROPERTY” – “DEVICES” – “SD CARD”, and press  $\square$ .  
The following information is displayed.

---

**SD STANDARD:** Whether the SD card has been formatted in compliance with the SD/SDHC standard is displayed.

**SUPPORTED:** The card format complies with the SD/SDHC standard.

**NOT SUPPORTED:** The card format does not comply with the SD/SDHC standard.

---

<b>USED:</b>	Used memory [bytes]
<b>BLANK:</b>	Free memory [bytes]
<b>TOTAL:</b>	Total memory [bytes]
<b>NUMBER OF CLIPS:</b>	Number of clips contained on the SD card when the clips were copied onto the SD card with a proxy or P2 camera-recorder
<b>PROTECT:</b>	Write-protect status

---

• Proxy recording is not possible with this unit.

- 4 Press  $\square$ .
- 5 Press [MENU/MODE CHK] to exit the procedure.

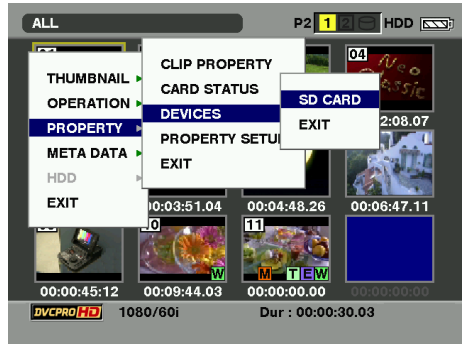

# Clip playback

## Playing back clips

**1** Display the thumbnail display screen.

**2** With cross cursor operation, move the cursor (yellow frame) to the target clip.

**3** Press **△**.

Playback starts from the clip where the cursor is positioned. When this clip has finished playing back, the subsequent clips are played back in turn, and when the last clip has been played back, the thumbnail screen is restored.

- When “TEXT MEMO” is allocated to [USER] (Page 97), text memos can be added during playback. (but shot marks cannot be added)



- When playing back a clip, there is no need to select it (provided that the bluish-green frame is displayed on the thumbnail).
- It is not possible to play back clips for which the **X** defective clip indicator or **?** unknown clip indicator (Page 37) is displayed.
- The clips whose clip numbers are displayed in red cannot be played back.
- By changing the thumbnail display setting (Page 38), you can play back only the clips you have selected, or play back only the clips in which text memos have been inserted, for instance.
- If you press **▽** while playing back the clip, the playback stops and the thumbnail screen is restored.
- If the playback is stopped, the cursor position moves to the clip played back just before this clip.
- The next playback start position is determined according to the setting menu: “THUMBNAIL”–“SETUP”–“PLAYBACK RESUME” (Page 39).
- If you play back various formats (AVC-Intra100, AVC-Intra50, DVCPRO HD, DVCPRO50, DVCPRO, DV), the images and sounds are distorted between clips. This is not a malfunction.
- Easy playback of clips stored on the external hard drive is available also. Refer to “Easy playback of clips on the hard drive (For viewing materials)” on page 78.
- If you change the thumbnail display screen to the text memo display, you can start playback from the text memo position. Refer to “Playback from the text memo position” on page 60.
- The unit does not support hot swap playback (Switching cards while playing back the continuously recorded clips which were recorded onto multiple cards).
- If the clips in AVC-Intra50 and AVC-Intra100 formats are played back, they are not output to the DVCPRO/DV input/output connector (IEEE1394).

(Continued on the next page)

## Clip playback (continued)

### Playing back clips (continued)

#### Basic playback operations

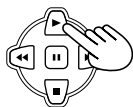

##### Play (▶)

When this button is pressed during stop, playback begins from the start of the selected clips\*. When it is pressed during playback, the variable-speed playback (Page 59) is set, and the clips are played back at the 1x speed.

\* If you do not move the cursor when "PLAYBACK RESUME" is "ON", the playback starts from the last stop position.



##### Rapid forward playback (▶▶)

When this button is pressed during playback, the clip currently selected is played rapidly in the forward direction (at 4x normal speed). When the thumbnail display screen is not displayed, this type of playback is possible even during stop. If the button is held down, the playback speed is increased. (The setting value for "SPEED MAX" on the setting menu "PLAYBACK FUNCTIONS" is set.) When it is pressed during pause, the next clip or text memo is selected for playback. (Depends on the setting for the "SEEK POS" item on the setting menu "PLAYBACK FUNCTIONS".)



##### Rapid reverse playback (◀◀)

When this button is pressed during playback, the clip currently selected is played rapidly in the reverse direction (at 4x normal speed). When the thumbnail display screen is not displayed, this type of playback is possible even during stop. If the button is held down, the playback speed is increased. (The setting value for "SPEED MAX" on the setting menu "PLAYBACK FUNCTIONS" is set.) When it is pressed during pause, the previous clip or text memo is selected for playback. (Depends on the setting for the "SEEK POS" item on the setting menu "PLAYBACK FUNCTIONS".)



##### Stop (■)

If you press during playback, the playback stops and the thumbnail display screen is restored.





##### Pause (||)

When this button is pressed again, playback is resumed.

### Single clip playback

When "ONE CLIP" is assigned to [USER] (Page 97), if you press the [USER], only the clip at the cursor position can be played back.

- When the single clip playback finishes or you press , the playback stops and the thumbnail display screen is restored. The cursor moves to the next clip.
- During the single clip playback, all buttons but  are disabled.
- The single clip playback starts from the beginning of the clip, regardless of whatever setting for "PLAYBACK RESUME" is made.
- During the single clip playback, you cannot add a text memo.

## Variable-speed playback

You can change the playback speed and search for specific locations.

- 1 Press **[A]** during playback.  
1X ▷ is displayed.
- 2 Press **[REVERSE/PAUSE]** and change the playback speed.  
X ▷ /X ▷▷ or X < /X << is displayed.
  - Each time you press the button, the playback speed changes.  
(The maximum value for the variable speed is determined according to the setting value for "SPEED MAX" on the setting menu "PLAYBACK FUNCTIONS" (Page 99).)  
No sound will be played back at over the 10x speed. If you continue to press the button, the playback speed changes in order. The sound of the variable-speed playback will not be played back during the clip easy playback from the hard drive.
  - Use **[REVERSE]** to increase the speed, and **[PAUSE]** to decrease it.
  - The playback speed becomes 0 by pressing **[REVERSE]** and **[PAUSE]** at the same time.

To return to normal playback, press **[A]**.

During variable-speed playback (including 1x speed) of native recorded materials, the pulldown sequence may not be even.

## Clip and text memo forward/reverse

- 1 Press **[A]** during playback to establish the pause mode.
- 2 Press **[REVERSE]** or **[PAUSE]**.  
The playback position moves to the beginning of clip or text memo position according to the setting value on the setting menu "SEEK POS" (Page 99). CLIP or CLIP&T ▷▷▷, CLIP or CLIP&T <<< is displayed during operation.

## Rapid forward/rapid reverse playback

- 1 During playback, press **[REVERSE]** or **[PAUSE]**.  
The clip is played back rapidly at 4x normal speed in the forward or reverse direction. When the button is held down, the speed increases.  
(The maximum speed is determined according to the setting value for "SPEED MAX" on the setting menu "PLAYBACK FUNCTIONS" (Page 99).)  
▷▷▷ or <<<< is displayed during operation.

To return to normal playback, press **[A]**.

## Frame feed playback

- 1 Press **[A]** during playback to establish the pause mode.
- 2 Press **[FRAME FEED]**.
  - The clips are fed frame by frame in the forward direction using **[REVERSE]** and in the reverse direction using **[PAUSE]**.  
▷▷▷ or <<<< is displayed during operation.
  - When the button is held down, frame feeding is continued.

To return to normal playback, press **[A]**.

## Repeat playback

The selected clip is played repeatedly.

- 1 Press **[THUMBNAIL/MODE]** to display the normal display screen.
- 2 Press **[MENU/MODE CHK]**.
- 3 Using **[REVERSE]**, **[A]** and **[PAUSE]**, select "PLAYBACK FUNCTIONS" – "REPEAT PLAY" – "ON", and press **[PAUSE]**.
- 4 Press **[MENU/MODE CHK]** twice.

The repeat playback icon appears on the normal display screen.

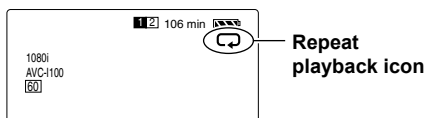

- 5 Press **[THUMBNAIL/MODE]** to display the thumbnail display screen.
- 6 Using **[REVERSE]** or **[PAUSE]**, move the cursor (yellow frame) to the repeat playback clip, and press **[PAUSE]**.
- 7 Press **[MENU/MODE CHK]**.
- 8 Using **[REVERSE]**, **[A]** and **[PAUSE]**, select "THUMBNAIL" – "SELECTED CLIPS", and press **[PAUSE]**.
- 9 Press **[A]**.  
The selected clip is now played back repeatedly.

- Playback is repeated until **[REVERSE]** is pressed.
- If "SELECTED CLIPS" is not selected for the thumbnail display setting, all the currently displayed clips which can be played back will be played back repeatedly.
- To turn off the repeat playback setting, select "OFF" in step 3.
- When rapid forward or rapid reverse playback is performed during repeat playback, playback stops after the first playable clip or last playable clip is played back.

## Clip playback (continued)

### Adding text memos

- 1 During recording, playback or thumbnail display, press [USER] to which the “TEXT MEMO” was allocated.
  - If you press this button during recording or playback, the text memo is added to the position at which the button is pressed.
  - If you press this button while the thumbnail display screen is displayed, the text memo is added to the clip’s thumbnail image position (normally the beginning of the clip).

- Up to 100 text memos can be added to one clip.
- During playback, if you press the [USER] to which the “TEXT MEMO” was allocated, the playback image may tentatively stops. This is not a malfunction.
- The text memo can be added only at 1x speed or while paused.
- During the single clip playback or LOOP REC, you cannot add a text memo.

### Playback from text memo position

- 1 Display the thumbnail display screen.
- 2 Press [MENU/MODE CHK].
- 3 Using  $\nabla$ ,  $\triangle$  and  $\square$ , select “THUMBNAIL” – “TEXT MEMO CLIPS”, and press  $\square$ .  
Thumbnails of the clips to which text memos were added now appear at the top of the LCD monitor screen. Information about the text memo of the clip pointed by the cursor appears at the bottom of the LCD monitor screen.

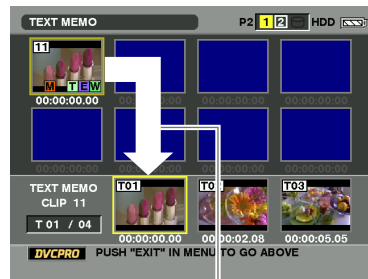

The cursor moves here.

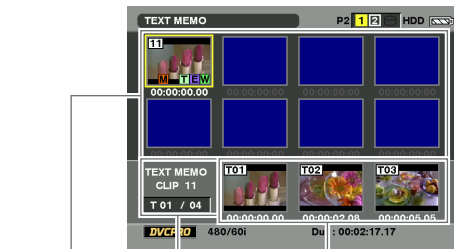

Thumbnail display area

Indicated here are the still images located at the text memos.

Indicated here is the total number of text memos which were added to the clips.

When the text memo display screen is displayed as above, the image by EE output is displayed BLACK.

- 4 Using  $\triangleright$  and  $\triangleleft$ , move the cursor to the clip which is to be played back, and press  $\square$ .  
The cursor moves to the bottom of the LCD monitor screen.

- 5 Using  $\triangleright$  or  $\triangleleft$ , move the cursor to the number of the text memo to be played back, and press  $\triangle$ .

Playback starts from the time code position of the text memo where the cursor is positioned. When playback ends at the end of the clip, the thumbnail screen is restored, and the cursor returns to the time code position where playback was started.

- 6 Press [MENU/MODE CHK], and then select “EXIT” using  $\nabla$ ,  $\triangle$ , and press  $\square$ .

When EXIT is assigned to the [USER], if you press [EXIT/2], the cursor returns to the top of the thumbnail screen.

- Text memos can be added while clips are being played back or recorded. Refer to the above “Adding text memos”. Note that text memos cannot be added during playback from the above text memo position.
- During playback from the text memo position, all buttons but  $\nabla$  are disabled.



## Deleting text memos

- 1 Perform the operation from steps 1 to 4 in “Playback from text memo position”, and move to the bottom of the text memo screen.
- 2 Move the cursor to the text memo to be deleted, and press **[M]**.  
A multiple number of text memos can be selected.
- 3 Press **[MENU/MODE CHK]**, and then select “OPERATION” – “DELETE” using **[V]**, **[A]** and **[M]**.
- 4 Select “YES”, and press **[M]**.  
The text memo is now deleted.

## Dividing and copying clips using text memos

- 1 Perform the operation from steps 1 to 4 in “Playback from text memo position”, and move to the bottom of the text memo screen.
- 2 Move the cursor to the text memo to be copied, and press **[M]**.  
A multiple number of text memos can be selected.
- 3 Press **[MENU/MODE CHK]**, and then select “OPERATION” – “COPY” using **[V]**, **[A]** and **[M]**, and press **[M]**.
- 4 Using **[V]** or **[A]** and **[M]**, select the slot with the copy destination card, select “YES”, and press **[M]**.  
Copying is now executed.
- 5 When the completion message has appeared, press “OK” (**[M]**).

- The block between the selected text memo and the next text memo is copied. If there is no text memo after the selected text memo, the block from the text memo position to the end of the clip will be copied.
- While copying is underway, the progress made in copying and cancel are displayed. To stop the copying at any time, press **[M]**. The “YES/NO” confirmation screen now appears. Using **[V]** and **[M]**, select “YES”.

## Replacing thumbnail images

The thumbnail display image of clip can be replaced with the still image at the text memo position.

- 1 Perform the operation from steps 1 to 4 in “Playback from text memo position”, and move to the bottom of the text memo screen.
- 2 Using **[▶]** or **[◀]**, move the cursor to the text memo still image you wish to make the thumbnail display image.
- 3 Press **[MENU/MODE CHK]**.
- 4 Using **[V]**, **[A]** and **[M]**, select “OPERATION” – “EXCH. THUMBNAIL”, and press **[M]**.

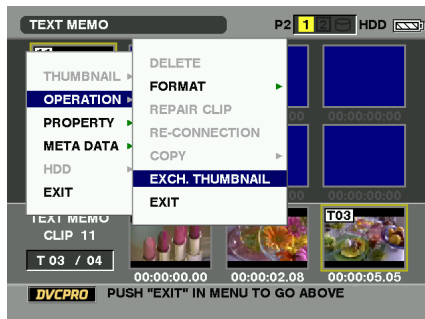

- 5 Select “YES”, and press **[M]**.  
The thumbnail display image is replaced with the still image at the cursor position.

- You can view the thumbnail change position (number of frames from the start) using the clip information display “THUMBNAIL” item (Page 44). “0” is normally displayed for the thumbnail of the start frame.
- Playback from a thumbnail begins from the start of the clip even when the thumbnail has been changed.

# Outputting images to an external monitor for playback

You can connect an external monitor to the output connector of the unit, output clips to the external monitor and play them back on the monitor.

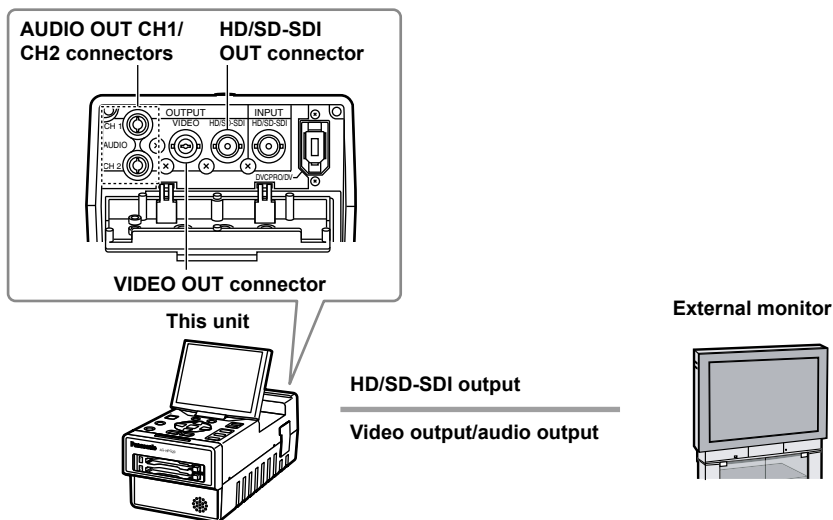

## Setting the outputs

- 1 Hold down [POWER] for at least 1 second to turn the power on.
- 2 Press [THUMBNAIL/MODE].  
The normal display screen appears.
- 3 Press [MENU/MODE CHK].
- 4 Using  $\nabla$  and  $\triangle$ , select "AV OUT SETUP" setting item, and press  $\square$ .
- 5 Using  $\nabla$  and  $\triangle$ , select the setting, and press  $\square$ .
- 6 Press [MENU/MODE CHK] to end the procedure.

## Adjusting the output volume level during recording and playback

The volume level of the sound from the speaker or headphone jack can be adjusted by pressing  $\text{G} \text{D}$  during recording or playback.

The volume level of the sound from the speaker or headphone jack can be adjusted by pressing [ALT/3] and  $\text{G} \text{D}$  when the thumbnail display screen is displayed. Refer to AV OUT SETUP screen on page 99.

- ALT function must be assigned to [ALT/3] on the setting menu "SW MODE" (Page 97).

## Adjusting the output volume level during variable-speed playback

The volume level of the sound from the speaker or headphone jack can be adjusted by pressing [ALT/3] and  $\text{G} \text{D}$  during variable-speed playback. Refer to AV OUT SETUP screen on page 99.

- ALT function must be assigned to [ALT/3] on the setting menu "SW MODE" (Page 97).

# Recording data on P2 cards

You can connect a digital video component equipped with a SDI connector or IEEE 1394 connector, and record video signals, audio signals or time codes, etc. on the unit.

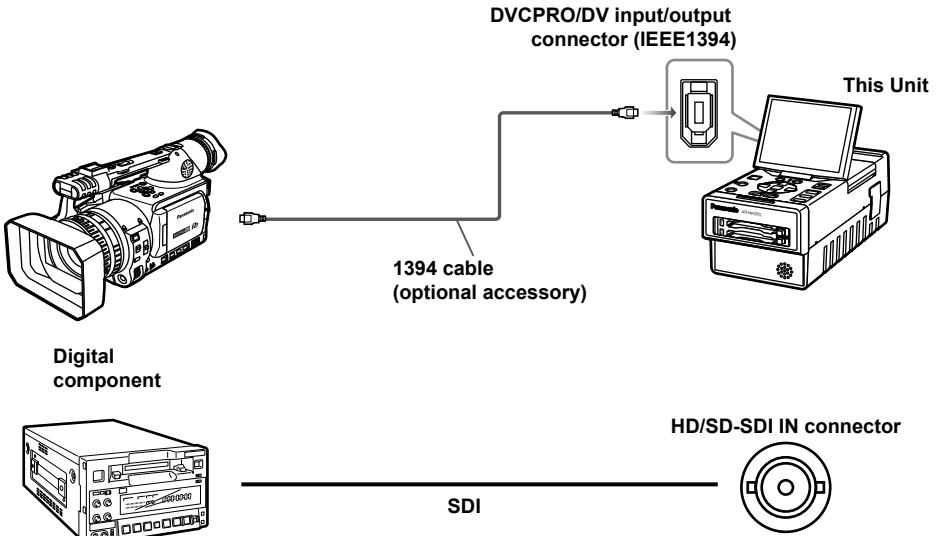

Playback  
Recording

## Recording

**1** Hold down [POWER] for at least 1 second to turn the power on.  
The thumbnail screen appears.

**2** Press [THUMBNAIL/MODE].  
The normal display screen appears.

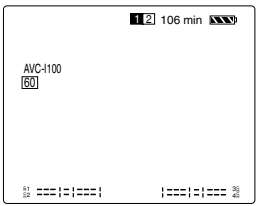

**3** Press [MENU/MODE CHK].

**4** Set the following items.

Setting item	Menu
Input signal	"RECORDING SETUP"– "INPUT SELECT"
Recording format*	"RECORDING SETUP"– "SYS FORMAT", "REC FMT(SD)", "REC FMT(HD)"
Time code, user's bit	"TIMECODE SETUP"

\* The video format of the input signal and the recording format on this unit must be the same. For details, refer to the setting menu "RECORDING SETUP" (Page 90) and "TIMECODE SETUP" (Page 93).

**5** Press the two [REC] buttons together.  
Recording now starts.

- To stop the recording, press .
- While recording is underway, text memos or shot marks assigned to [USER] (Page 97) can be added.

(Continued on the next page)

## Recording data on P2 cards (continued)

### Recording (continued)

- By making HD-SDI/1394 connection to a camera recorder equipped with an external device control function, the unit can be made to start recording, pause recording, etc. by the camera recorder. For details on devices compatible with HD-SDI connection and settings on this unit, refer to “AUTO REC” on the setting menu “RECORDING SETUP” (Page 91).  
Also, refer to the operating instructions of the camera recorder.
- Recording is not available in PC mode (Page 25).
- The unit does not support native recordings.
- Before recording, check that video signals are being input.
- If the input signal format changes during recording, recording does not proceed properly.
- Do not stop the signal output at the external device or disconnect the device’s cable during recording. Otherwise, the device may not recognize signals when recording is undertaken again.
- Do not start recording in the condition that invalid signals or continuously distorted signals are input. The device may not operate normally.
- When time information data identification code (DBB1) in SLTC or SVITC superimposed onto SDI input signals is lost or ON/OFF is switched during EE/recording, the images may be distorted at those timings. (When SDI is set on the setting menu “INPUT SELECT” (Page 90))

The followings are restrictions when 1394 input is selected.

- No signals are recorded if the same video signals as those for recording format are not input.
- Recording in AVC-Intra100 and AVC-Intra50 formats is not possible.
- Recording sound is 4ch for DVCPRO HD input (Page 118).

### 2-slot continuous recording

If P2 cards have been inserted into both of the P2 card slots, you can continuously record images first on one card and then on the other. While images are being recorded on one card, you can replace the other card with a fresh card and in this way record continuously onto 3 or more cards. (This is called hot swap recording.) However, the fresh P2 card may not be recognized when it is inserted into the empty slot at certain timings (Before and after when recording continuously from one slot to the other). It is recommended that you insert a fresh P2 card while the card on which images are being recorded still has at least one minute of remaining memory.

When “SLOT SEL” is assigned to [USER] for the USER1-3 items (Page 97) on the setting menu “SW MODE”, you can change the slot targeted for recording at the touch of a button.

- Changing slots is not possible while recording is in progress, so do this in the recording standby status.
- The unit does not support hot swap playback.

### Waveform monitor (WFM) displays

You can display the simplified waveform monitor on screen, and monitor the images.

The monitor can be displayed when the “WFM” item on the setting menu “DISPLAY SETUP” screen is set.

- When “WFM” is assigned to [USER] for the USER1-3 items (Page 97) on the setting menu “SW MODE”:

**When the “WFM” setting on “DISPLAY SETUP” is “OFF”**

Each time the button is pressed, the setting is switched as follows: “WAVE”→“VECTOR”→“OFF”→“WAVE”.

**When the “WFM” setting on “DISPLAY SETUP” is “WAVE”**

Each time the button is pressed, the setting is switched as follows: “WAVE”→“OFF”→“WAVE”.

**When the “WFM” setting on “DISPLAY SETUP” is “VECTOR”**

Each time the button is pressed, the setting is switched as follows: “VECTOR”→“OFF”→“VECTOR”.

- The output with superimposed WFM is linked to the selection on the setting menu “OSD OUT SEL”.
- The display appears during clip playback and when input signals are being supplied.

## Time code displays

You can change what is displayed in the time code display area. (Page 80)

### 1 Press [COUNTER].

Each time the button is pressed, the data changes as follows.

<b>TC:</b>	Time code displays
<b>UB:</b>	User's bit value
<b>FR:</b>	Frame rate information
<b>No display:</b>	No data displayed
<b>COUNTER:</b>	Counter display (Except for playback process)

### Resetting the counter value

On the normal display screen, press [RESET] while the counter value is displayed.

- When the time code display during recording is COUNTER, you can select whether to display the counter value by clip, or to display the total counter value on the setting menu "DISPLAY SETUP" – "REC COUNTER".

## Setting the recording time code

You can select the recording time code at the "EXT TC REGEN" item on the setting menu "TIMECODE SETUP". For details, refer to the setting menu "TIMECODE SETUP". (Page 93)

## Setting the recording time code

On the setting menu "TIMECODE SETUP", set the following time code related items. (Page 93)

- TC MODE
- TCG
- TC PRESET

## Specifying the time code (TC PRESET)

Set the time code value on "TC PRESET" so you can record a value of your choice as the initial setting for the time code to be used at the start of recording.

### 1 Hold down [POWER] for at least 1 second to turn the power on.

### 2 Select "OFF" on the "EXT TC REGEN" item on the setting menu "TIMECODE SETUP".

- Basic operations on the setting menus (Page 88)

### 3 Select "CHANGE" for the "TC PRESET" item on "TIMECODE SETUP", and press [u].

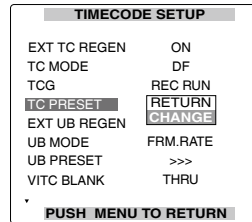

### 4 When the following screen appears, set the time code value.

- Using [v] and [d], select the time code value.

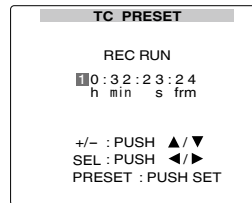

Using [d], move to the next digit, and using [v] and [d], select the time code value again.

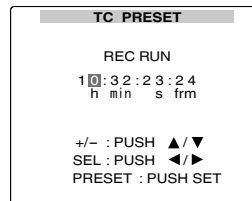

If [RESET] is pressed while setting the time code, the time code value will be reset to zero.

(Continued on the next page)

## Recording data on P2 cards (continued)

### Setting the recording time code (continued)

#### Specifying the time code (TC PRESET) (continued)

**5** After the time code value has been set, press **[M]**.

**6** Using **[Δ]**, move to “YES”, and press **[M]**.

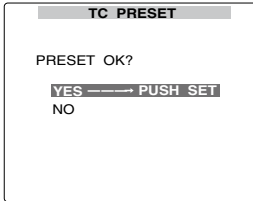

**7** Press **[MENU/MODE CHK]** 2 times to release the menu mode.

### Set the user's bit

Setting user's bit allows you to store 8-digit information (such as the date and time) in the hexadecimal format on the sub code area. User's bit is automatically saved in the memory and retained after you turn off the power.

**1** Hold down **[POWER]** for at least 1 second to turn the power on.

**2** Select “OFF” for the “EXT UB REGEN” item on the setting menu “TIMECODE SETUP”.

- Basic operations on the setting menus (Page 88)

**3** Select “USER” for the “UB MODE” item on “TIMECODE SETUP”.

**4** Select “CHANGE” for the “UB PRESET” item on “TIMECODE SETUP”, and press **[M]**.

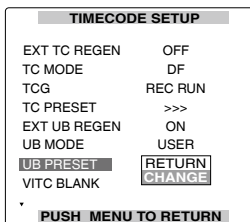

**5** Set the user's bit.

Using **[▽]** and **[Δ]**, select the user's bit characters.

- You can use numbers from 0 to 9 and letters from A to F.

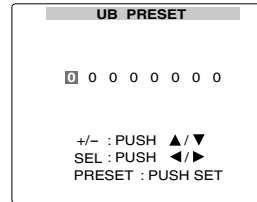

Using **[▶]**, move to the next digit, and press **[▽]** and **[Δ]** again to select the character.

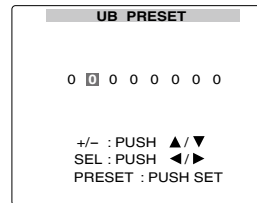

If **[RESET]** is pressed while setting the user's bit, the user's bit value will be reset to zero.

**6** After the user's bit has been set, press **[M]**.

**7** Using **[Δ]**, move to “YES”, and press **[M]**.

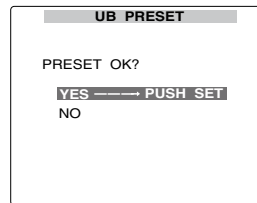

**8** Press **[MENU/MODE CHK]** 2 times to release the menu mode.

# Copying data from P2 cards to the hard drive

You can connect a hard drive equipped with a USB 2.0, and copy data from P2 cards onto the hard drive.

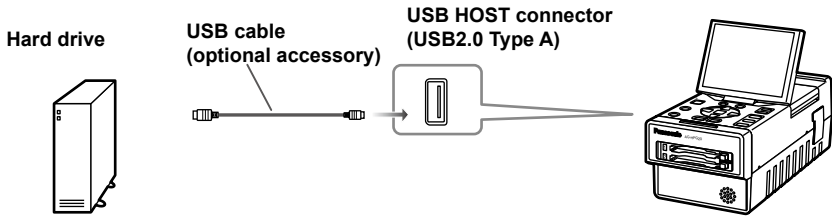

---

---

## The following conditions must be met when using a USB connection.

- This unit supports only USB 2.0. Use a USB 2.0-compatible hard drive.
  - Only one hard drive must be connected.
  - Operations can not be guaranteed if a hub or other device is connected between the unit and hard drive. Use of a USB cable no longer than 3 meters is recommended.
- 
- 
- Use a hard drive which meets the following conditions.
    - 1) The hard drive must be used within its guaranteed operating ranges (temperature, etc.).
    - 2) The hard drive must not be installed where it will be susceptible to vibration or be unstable.
  - Hard drives with a memory size of 2 TB or more are not supported.
  - In the case of some hard drives, the intended operations may not be performed properly.
  - A hard drive with a SATA (serial ATA) or PATA (parallel ATA) interface connected through a USB conversion cable may not be recognized.
  - While formatting or copying is in progress, do not disconnect the cables, eject the P2 cards or turn off the power of the unit or hard drive. Such actions will require the power to be turned on again.
  - A hard drive is a high-precision device: as such, when it is used under certain conditions, it may quite possibly fail to read or write data.

Panasonic disclaims all liability for the loss of data caused by a failure of or any form of trouble occurring in the hard drive, and also for any direct and indirect damages suffered as a result of such failure or trouble. Users are asked to bear this in mind.
  - When the data on the hard drive used for copying data from the unit has been updated by a PC or other devices, no guarantees can be made for the subsequent operations involving the unit or for the data on the hard drive.
  - It is recommended that you repair P2 cards containing defective clips\* before copying their data using the unit.
    - \* A “defective clip” is a clip with some kind of problem in its recording which was caused because a P2 card was ejected or the power was turned off while its recording was still in progress, and it is indicated by the  mark when the thumbnail screen is displayed.
  - If, when the drive mount converter which Panasonic makes available free of charge from its web site given below is used and the hard disk has been connected to a Windows PC, the hard disk partition can be mounted in the specified folder. Use this when there is an overlap between one or more already allocated network and drives so that one or more partitions are concealed as a result.

<https://www.pavc.panasonic.co.jp/pro-av/>
- 
-

## Copying data from P2 cards to the hard drive (continued)

### Switching to the USB HOST mode

- 1** Hold down [POWER] for at least 1 second to turn the power on.  
The thumbnail screen now appears.
- 2** Press [THUMBNAIL/MODE] to display the normal display screen.
- 3** Press [MENU/MODE CHK].
- 4** Using  $\nabla$ ,  $\triangle$  and  $\square$ , select "OTHER FUNCTIONS" – "PC MODE SELECT", and press  $\square$ .
- 5** Using  $\nabla$  and  $\triangle$ , select "USB HOST", and press  $\square$ .
- 6** Press [MENU/MODE CHK] twice to display the normal display screen.

- 7** Hold down [THUMBNAIL/MODE] for at least 2 seconds.  
The USB HOST mode is now established, and "USB HOST" appears at the bottom of the thumbnail screen.



- Use a hard drive with enough memory to accommodate the data to be copied.

### To exit the USB HOST mode

- 1** Hold down [THUMBNAIL/MODE] for at least 2 seconds.  
The USB HOST mode is cancelled, and "USB HOST" disappears at the bottom right of the screen.

### Usable hard drives

The following hard drive can be used.

- Panasonic portable hard disk unit for P2 store (AJ-PCS060G)
- Any hard drive which can be connected using USB 2.0

- USB bus power (5 V, 0.5 A) is also supported, but some hard drives cannot be started up using it. If this is the case, supply power from a separate source to the hard drive.
- Some hard drives may not operate properly.
- Do not use USB memories or other removable media.



## Types of hard drives and usable functions

The functions that can be used differ from one hard drive to another. The hard drive type is displayed following [PARTITION:] on the left of the HDD EXPLORE screen in the unit's HOST mode.

Hard drive type	Features	Functions that can be used
TYPE S	This is a special format for writing and reading all the data on one card at a time at high speed. This is the format used when a hard drive is formatted by the unit.	Writing and reading all the data on one card at a time, thumbnail displays, reading data one clip at a time, clip playback, formatting
P2STORE	This refers to the P2 store (AJ-PCS060G) hard drive. It cannot be used to write data.	Reading all the data on one card at a time, thumbnail displays, reading data one clip at a time, clip playback
FAT	The first basic partition format is FAT16 or FAT32. When the [CONTENTS] folder is not present in the root folder of the partition, create it.	Thumbnail displays, Writing and reading on one clip at a time, clip playback, formatting <ul style="list-style-type: none"> <li>• After this drive has been formatted by the unit, it is treated as a "TYPE S" drive.</li> </ul>
OTHER	All other types of hard drives <ul style="list-style-type: none"> <li>• This applies when a file system other than FAT16 and FAT32, such as NTFS, is used as a first partition.</li> </ul>	Formatting <ul style="list-style-type: none"> <li>• After this drive has been formatted by the unit, it is treated as a "TYPE S" drive.</li> </ul>

# Copying data from P2 cards to the hard drive (continued)

## Formatting the hard drive

Formatting initializes the hard drive to a format which can be used by TYPE S.

- Bear in mind that when the hard drive is formatted, all the existing data on that drive will be erased.

- 1 Switch to the USB HOST mode.
- 2 Connect the USB hard drive.
- 3 Press [MENU/MODE CHK].
- 4 Using  $\nabla$ ,  $\triangle$  and  $\square$ , select “HDD” – “EXPLORE”, and press  $\square$ .  
The HDD EXPLORE screen is opened.

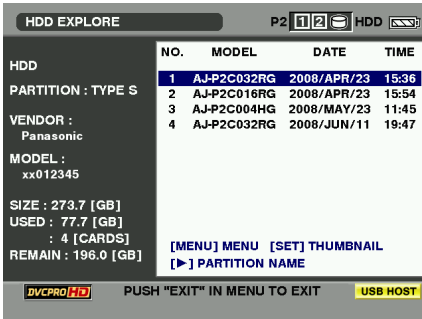

- 5 Press [MENU/MODE CHK], select “OPERATION” – “FORMAT (HDD)” using  $\nabla$ ,  $\triangle$  and  $\square$ , and press  $\square$ .

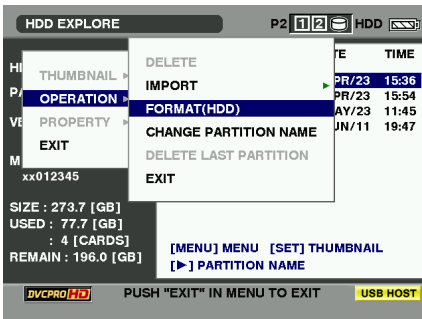

- 6 Select “YES”, and press  $\square$ .
- 7 When the confirmation message appears again, select “YES”, and press  $\square$ .  
The hard drive is now formatted.
- 8 When the completion message has appeared, press “OK” ( $\square$ ).

## Exporting data to a hard drive in 1-card increments

If you are using a TYPE S hard drive, you can export all the data on one P2 card at a time to the hard drive (write data from P2 cards onto the hard drive). Before proceeding, use the unit to format the hard drive. (Bear in mind that all the data recorded on the hard drive will be erased.) The data of up to 23 cards can be stored on the hard drive. The computer or other device used will recognize each P2 card from which the data is exported to be a separate drive.

- 1 Switch to the **USB HOST** mode.
- 2 Connect the **USB hard drive**.  
Format the hard drive only if it has not been formatted by the unit.  
Refer to "Formatting the hard drive" (Page 70).
- 3 Insert the **P2 card**.
- 4 Press **[MENU/MODE CHK]**.
- 5 Using **[↓]**, **[↑]** and **[M]**, select "**HDD**" – "**EXPORT**", and press **[M]**.



- 6 Select the number of the P2 card slot where the P2 copy source card was inserted, and press **[M]**.  
If you select "ALL SLOT", all data on all cards which have been inserted is exported at a time.
- 7 Select "**YES**", and press **[M]**.

- A progress bar is displayed while the data is being exported.
- To stop exporting the data at any time, press **[M]**, move the cursor to "YES" on the "CANCEL" confirmation display, and press **[M]**. If the export process has completed for a card before cancellation, the copy has been completed.
- It will take less time for the exporting to be completed if you set it up so that verification of the two sets of data is not required during exporting. To do this, set the menu item "HDD" – "SETUP" – "VERIFY" to "OFF".
- The copying of the P2 card data will also be terminated if the process is aborted during verification of the two sets of data.

When the exporting is completed, "COPY COMPLETED!" appears on the screen.

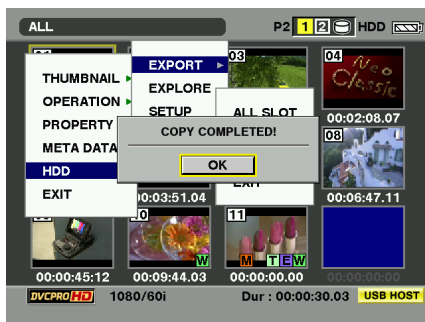

## Copying data from P2 cards to the hard drive (continued)

### Exporting one clip at a time to a hard drive

Clips can be copied onto the hard drive in FAT type.

- 1 Switch to the USB HOST mode.
- 2 Display the thumbnail display screen.
- 3 Select the clip on the P2 card to be copied onto the hard drive.
- 4 Press [MENU/MODE CHK].
- 5 Using  $\leftarrow$ ,  $\rightarrow$  and  $\square$ , select “OPERATION”–“COPY”–“HDD (FAT)”, and press  $\square$ .  
If the hard drive in FAT type is not connected, the menu cannot be activated.
- 6 Select “YES”, and press  $\square$ .  
Clip copying now starts.

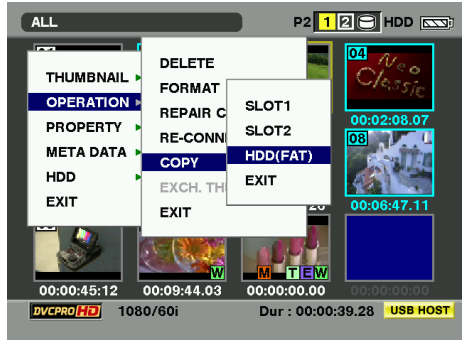

- While clips are being copied, do not turn off the power or eject the card. Otherwise, defective clips will be produced. If defective clips are produced, delete them, and copy the original clips again. Copy incomplete clips after having connected them (Page 41).
- To stop the copying process at any time, press  $\square$  to cancel the copying. The partially copied clip at the copy destination will be deleted.  
If there is a clip with the same GLOBAL CLIP ID –one which, for instance, was previously copied to the copy destination– “OVER WRITE” will appear. To overwrite the existing clip, select “YES” or to cancel the overwriting, select “NO”, and press  $\square$ . (When you copy some portion of a clip which has been recorded on a multiple number of P2 cards, “OVER WRITE” also appears when copying the remaining portion of the clip.)

---

---

Clips cannot be copied when any of the following error messages are displayed.

- "LACK OF REC CAPACITY!"

Clips will not be copied because there is insufficient space available on the hard disk.

- "UNKNOWN CONTENTS FORMAT!"

Clips will not be copied because the selected clips include defective clips.

- "TOO MANY CLIPS!"

Clips will not be copied because too many clips have been selected.

Up to 1000 clips can be copied onto the FAT type of hard drive on this unit.

If you have created on the hard drive a clip whose size is larger than the capacity of one P2 card, such a clip cannot be returned to the P2 card.

---

---

- Clips displayed by the  defective clip indicator cannot be copied.

- It may not be possible to copy clips for which the  unknown clip indicator is displayed.
- 
-

# Copying data from P2 cards to the hard drive (continued)

## Hard drive data display

You can display the hard drive information.

- 1 Switch to the **USB HOST** mode.
- 2 Connect the **USB hard drive**.
- 3 Press **[MENU/MODE CHK]**.
- 4 Using **↓**, **↑** and **↵**, select **“HDD”** – **“EXPLORE”**, and press **↵**.  
The hard drive information is displayed.

With a **TYPE S** or **P2STORE** hard drive

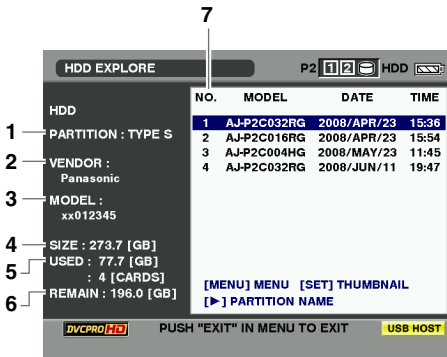

With **FAT**

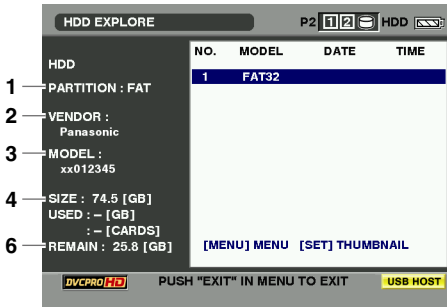

1. PARTITION	Type of hard drive
2. VENDOR	Name of vender
3. MODEL	Hard drive model name
4. SIZE	Total memory size of hard drive
5. USED	Amount of hard drive memory used (unit: GB) and area of P2 card used (unit: cards)
6. REMAIN	Remaining hard drive memory (unit: GB)*
7. Partition number	Partition (unit equivalent to one P2 card) number inside hard drive

\* As for the hard drive in FAT type, the remaining memory only for the target area on the hard drive is displayed.

- Using **▶** and **◀**, you can switch the display between the list with the dates/times and the names of the partitions given by the user. If the hard drive is in FAT type, switching is not possible.
- If the hard drive is in TYPE S type, when the hard drive thumbnail display or the EXPLORE display is on the screen, press **[MENU/MODE CHK]**, and select **“OPERATION”**–**“CHANGE PARTITION NAME”**. You can now apply a name (up to 20 characters) to the partition.  
(This is not possible with hard drives in other types than TYPE S.)



- If an invalid partition is present on the P2 store hard drive, the partition information is displayed in gray.
- With a FAT type of hard drive, only the first partition is displayed.

---

## Deleting the partition

You can delete the last partition on a TYPE S hard drive.

- 1 Switch to the **USB HOST** mode.
- 2 Connect the **USB hard drive**.
- 3 Press **[MENU/MODE CHK]**.
- 4 Using **▽**, **△** and **□**, select **“HDD”–“EXPLORE”**, and press **□**.  
The hard drive information is displayed.
- 5 Move the cursor and select the last partition.

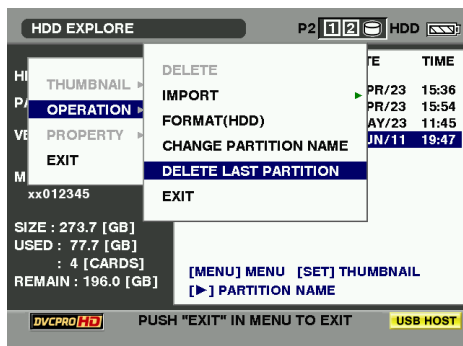

- 6 Select **“OPERATION”–“DELETE LAST PARTITION”**, and press **□**.

The last partition will be deleted. If the cursor is not present at the last partition, **“DELETE LAST PARTITION”** menu cannot become effective.

- 
- Only the last partition can be deleted. The deleted partition cannot be restored. Check this point before deleting.
  - Partitions wherever in the middle position cannot be deleted.
-

## Copying data from P2 cards to the hard drive (continued)

### Thumbnail displays of clips on the hard drive

You can also display and manage thumbnails of the clips stored on the hard drive just as you can with clips on the P2 cards installed in the unit.

#### 1 Display the HDD EXPLORE screen.

#### 2 Using $\nabla$ and $\triangle$ , select the partition to be displayed, and press $\square$ .

The clips of the partition are now displayed as thumbnails.

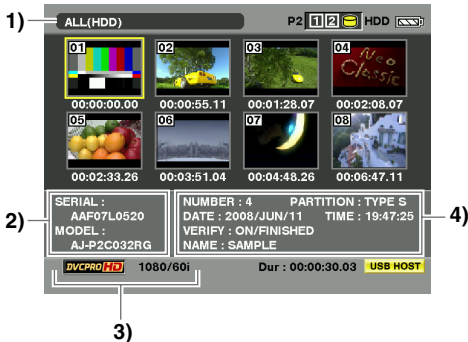
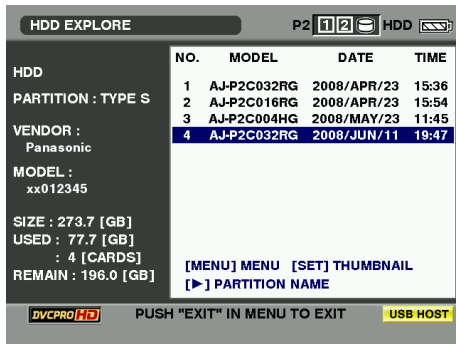

#### 1) Display statuses

Displays the thumbnail display status of the hard drive clips.

#### 2) Partition information

The following information is displayed.

<b>SERIAL:</b>	Serial number of P2 card
<b>MODEL:</b>	Model name of P2 card

#### 3) Recording mode and system format

The recording mode of the clip at the cursor position and system format are displayed.

### 4) Disk information

<b>NUMBER (NO.):</b>	Partition number (1 to 23)
<b>PARTITION:</b>	Type of the hard disk is displayed. (Page 69)
<b>DATE/TIME:</b>	Partition recording date/time
<b>VERIFY:</b>	Setting for verifying during recording, and verifying results
ON/	The two sets of data
FINISHED:	have been verified and found to match.
ON/	The two sets of
FAILED:	data have been verified and found not to match.
OFF:	The two sets of data were not verified.
	• “- -” is displayed in the case of a P2 store hard drive.
<b>NAME:</b>	Partition name

- When the menu is displayed and “EXIT” is selected, the HDD EXPLORE screen is restored.
- If necessary, you can change the displays on the thumbnail display screen. The steps taken to do this are the same as for the thumbnail displays for cards. Refer to “Changing the displays on the thumbnail display screen” (Page 38). Other operations (repair, connect, adding text memo, etc.) are not available.
- Clips can be deleted from the thumbnail display screen of the FAT type of hard drive, but other operations (repair, connect, adding text memo, etc.) are not available.
- With a FAT type of hard drive, clips after the first thousand clips will not be displayed.
- DATE/TIME is displayed in Coordinated Universal Time (UTC) with the P2 store hard drive.

### Displaying the clip information on the hard drive

You can display detailed information about clips on the screen, and check it. This information is the same as the properties of the clips on the P2 cards.

#### 1 Select the target clip on the thumbnail display screen of the hard drive.

You can display detailed information about clips on the screen, and check it.

#### 2 Press [MENU/MODE CHK].

#### 3 Using $\nabla$ , $\triangle$ and $\square$ , select “PROPERTY”–“CLIP PROPERTY”, and press $\square$ .

For details, refer to “Displaying the clip information” (Page 43).



# Connecting the hard drive for use

## Importing data from a hard drive to P2 cards

### Importing Data by the partition from TYPE S Hard Disk or P2 store

You can import data (load data from the hard drive to a P2 card) at one partition at a time (one card at a time) onto a P2 card of the same model number as the original card.

#### 1 Insert the P2 card that will serve as the import destination.

Insert the P2 card which has been formatted.

#### 2 Press [MENU/MODE CHK].

#### 3 Using $\nabla$ , $\triangle$ and $\square$ , select “HDD” – “EXPLORE”, and press $\square$ .

#### 4 Using $\nabla$ and $\triangle$ , select the copy source partition, and press $\square$ .

#### 5 Press [MENU/MODE CHK].

#### 6 Using $\nabla$ , $\triangle$ and $\square$ , select “OPERATION” – “IMPORT” – “ALL CLIP”, and press $\square$ .

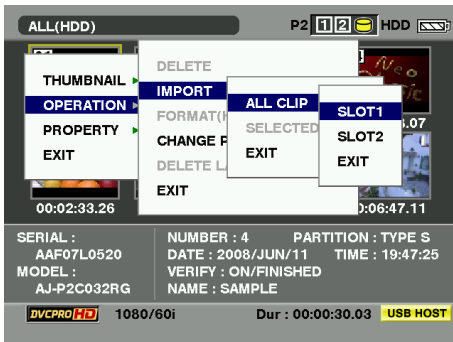

#### 7 Move the cursor to the number of the P2 card slot which serves as the import destination and which contains a formatted P2 card, and press $\square$ .

#### 8 Select “YES”, and press $\square$ .

Importing now begins.

When importing is completed, “COPY COMPLETED!” appears on the screen.

- When data has been imported to a P2 card which is different from the source P2 card, some clips may be incomplete (in which case, they will be indicated by the  $\square$  indicator). If this is the case, use the connecting function to reconfigure these clips. Refer to “Connecting incomplete clips” (Page 41).
- Using a menu setting, you can choose whether to verify the two sets of data when copying.
- It is not possible to import data one partition at a time onto a P2 card of a different model number. Instead, import data one clip at a time.

### Importing Data to a P2 Card by the clip

You can select the hard drive clips, and import them onto a P2 card.

#### 1 Insert the P2 card that will serve as the import destination.

#### 2 Press [MENU/MODE CHK].

#### 3 Using $\nabla$ , $\triangle$ and $\square$ , select “HDD” – “EXPLORE”, and press $\square$ .

#### 4 Using $\nabla$ and $\triangle$ , select the copy source partition, and press $\square$ .

#### 5 Select the clip to be copied.

#### 6 Press [MENU/MODE CHK].

#### 7 Using $\nabla$ , $\triangle$ and $\square$ , select “OPERATION” – “IMPORT” – “SELECTED CLIPS”, and press $\square$ .

#### 8 Using $\nabla$ and $\triangle$ , select the number of the P2 card slot whose data is to be imported, and press $\square$ .

#### 9 Select “YES”, and press $\square$ .

Importing now begins. When importing is completed, “COPY COMPLETED!” appears on the screen.

- Verifying is not executed when importing one clip at a time.
- For the precautions to be observed when importing one clip at a time, refer to “Copying clips” (Page 42).
- You cannot import to the P2 card clips whose size is larger than the capacity of the P2 card.

## Connecting the hard drive for use (continued)

### Easy playback of clips on the hard drive (For viewing materials)

Easy playback of clips saved on the hard drive can be performed.

- 1 Display the thumbnail display screen of the clips on the hard drive. (Page 76)
- 2 With cross cursor operation, move the cursor to the clip you wish to play back.
- 3 Press **[OK]**.  
The clip is played back.



The basic operation is the same as clip playback operation (Page 57). There are some different points as below.

- Depending on the playback format, playback proceeds while some images are skipped.
- Depending on the performance of hard drive or usage status, proper playback may not be possible.
- This unit does not support slow playback.
- No sound will be output during variable-speed playback.
- Text memos and shot marks cannot be added to the hard drive materials regardless of while playing back or displaying thumbnails.
- Do not make an impact on the hard drive.
- When the P2 store operation setting, "Impact detection in USB mode" is ON, and if you make an impact on P2 store while the clip on the hard drive is played, the playback may stop and the thumbnail display screen may be restored.
- While the easy playback of a clip on the hard drive is performed, do not insert or eject the P2 card. The subsequent operations may become invalid.
- Time code (TC/UB) is output discontinuously.

### Deleting clips on the hard drive

You can delete unwanted clips from a FAT hard drive by proceeding as follows.



- 1 Display the thumbnail display screen of the clips on the hard drive. (Page 76)
- 2 Select the clips to be deleted.
- 3 Press **[MENU/MODE CHK]**.
- 4 Using **[DOWN]**, **[UP]** and **[OK]**, select "OPERATION"– "DELETE", and press **[OK]**.
- 5 Select "YES", and press **[OK]**.
- 6 When the completion message has appeared, press "OK" (**[OK]**).

It may not be possible to delete clips for which the **[X]** defective clip indicator or **[?]** unknown clip indicator is displayed.

# Editing by means of external devices

## Editing data content on the P2 card (USB DEVICE mode)

You can connect a personal computer (Windows, Apple Macintosh) to this unit using a USB cable, and operate the contents on the unit's P2 cards from the computer.

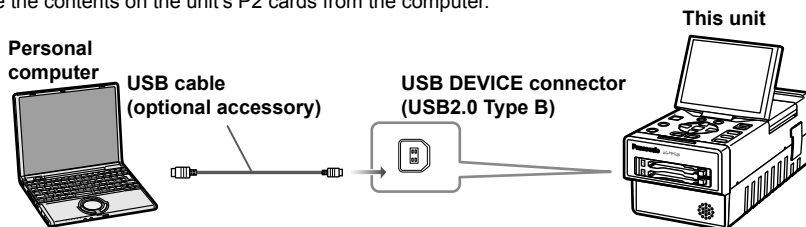

## Editing in the USB DEVICE mode

The following conditions must be met when using a USB connection.

- PCs mounted with Windows 2000 (SP4 or later version), Windows XP Professional (SP2 or later version), Windows Vista (Business or upgraded version) or Mac OS X10.4.8.
- When making a USB connection for the first time, install the P2 software from the CD-ROM provided with the unit onto the PC.
- This unit supports only USB 2.0. Use a USB 2.0-compatible PC.
- Only one PC must be connected.
- Operation will not be possible if a hub or other device is connected between the unit and PC. A USB cable more than 3 meters long must not be used. Otherwise, malfunctioning may occur.

**1** Hold down [POWER] for at least 1 second to turn the power on.

The thumbnail screen now appears.

**2** Press [THUMBNAIL/MODE] to display the normal display screen.

**3** Press [MENU/MODE CHK].

**4** Using  $\nabla$ ,  $\triangle$  and  $\square$ , select "OTHER FUNCTIONS"—"PC MODE SELECT", and press  $\square$ .

**5** Using  $\nabla$  and  $\triangle$ , select "USB DEVICE", and press  $\square$ .

**6** Press [MENU/MODE CHK] twice to display the normal display screen.

**7** Hold down [THUMBNAIL/MODE] for at least 2 seconds.

After "USB DEVICE" is displayed, "USB DEVICE CONNECT" is displayed once the file access becomes possible.

- The mode cannot be changed or menus cannot be displayed while the USB DEVICE mode is established.
- Do not remove the P2 card while the USB connection is established.

**8** Edit the data on the P2 card using the personal computer.

**9** After the data has been edited, disconnect the USB cable.

The display on the LCD monitor changes from "USB DEVICE CONNECT" to "USB DEVICE DISCONNECT."

- When disconnecting the cable, perform the "safe removal of hardware" procedure at the personal computer.

**10** Hold down [THUMBNAIL/MODE] for at least 2 seconds.

The normal display screen is restored.

- While the USB connection is established, the P2 card access LEDs will light up only when accessed.
- In the USB DEVICE mode, no signals can be output to an external monitor.

# Screen displays

## Normal displays

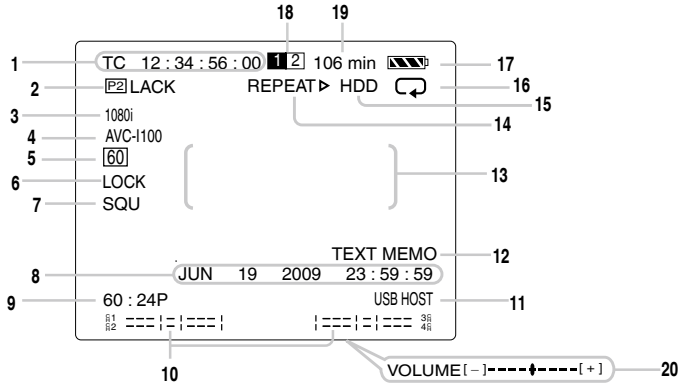

### 1 Time code displays

Each time [COUNTER] is pressed, the following data (or no information displayed) is selected in turn.

**COUNTER:** (Except for playback process)

Counter value

The counter value can be reset for each recording clip according to the setting menu "DISPLAY SETUP"—"REC COUNTER" (Page 105). In this case, CLIP is displayed at the beginning.

**TC:**

Time code value: [TC \*] is displayed when the time code value could not be read correctly from the P2 card.

**UB:**

User's bit: [UB \*] is displayed when the user's bit value could not be read correctly from the P2 card.

**FR:**

Information on the frame rate of recordings shot by the camera recorder such as the AG-HVX200

FR 60I	: 60i interlace mode (60 fields per second)
FR 60P	: 60p progressive mode (60 frames per second)
FR 30P	: 30p progressive mode (30 frames per second)
FR 24P	: 24p progressive mode (24 frames per second)
FR 24PA	: 24p advanced mode (24 frames per second)
FR 50I	: 50i interlace mode (50 fields per second)
FR 50P	: 50p progressive mode (50 frames per second)
FR 25P	: 25p progressive mode (25 frames per second)
FR—	: No information

**No information displayed**

### 2 Warning information

 :

This blinks when no P2 cards have been inserted or if all inserted P2 cards are write-protected.

 **FULL** :

This blinks when there is no more free memory on the P2 card.

 **LACK** :

This blinks when there is no more free memory necessary for LOOP recording on the P2 card or when only 1 P2 card is inserted.

 :

This blinks when there is no charge left in the battery.

 :

This blinks when the internal battery for the calendar has no charge left. (Page 32)

### 3 System format displays

During recording or on standby, the system format of the setting menu is displayed. During playback, the system format of the clip being played back is displayed.

**1080i:**

Recording and playback in the 1080i system format

**720P:**

Recording and playback in the 720p system format

**576i:**

(When "SYSTEM FREQ" on the setting menu "OTHER FUNCTIONS" is 50Hz)

Recording and playback in the 576i system format

**480i:**

(When "SYSTEM FREQ" on the setting menu "OTHER FUNCTIONS" is 59.94Hz)

Recording and playback in the 480i system format

#### 4 Compressed recording format display

During recording or on standby, the recording format of the setting menu is displayed. During playback, the compressed recording format of the clip being played back is displayed.

##### AVC-I 100:

AVC-Intra100 compressed recording format

##### AVC-I 50:

AVC-Intra50 compressed recording format

##### HD:

DVCPRO HD compressed recording format

##### 50M:

DVCPRO50 compressed recording format

##### 25M:

DVCPRO compressed recording format

##### DV:

DV compressed recording format

#### 5 System frequency displays

**60:** 59.94 Hz

**50:** 50 Hz

#### 6 INPUT LOCK

This is displayed when the following conditions are satisfied at the same time and the output signal is locked (synchronized) to the input signal.

- When INPUT is set for the setting menu "PLAYBACK FUNCTIONS"—"SDI IN LOCK" (Page 99).
- When the signal format is the same as the one set on the setting menu "RECORDING SETUP"—"SYS FORMAT"
- When the proper SDI signal is input

When LOCK is displayed, the output signal is locked (synchronized) to the SDI input signals, but does not match the phase.

#### 7 Squeeze recording display

This is displayed in the following conditions.

- When the setting menu "SYS FORMAT" is set to 480/60i or 576/50i and the setting menu "WIDE SELECT" is set to "WIDE"
- When squeeze-recorded (wide-recorded) images are played back
- When signals with WIDE information recorded are input with 1394 connection

#### 8 Date and time display

The mmm dd yyyy hh:mm:ss format (month/day/year/hours/minutes/seconds) is used to display the date and time.

- The date and time set by the camera recorder are displayed when the unit is connected to the AG-HVX200 or other camera recorder using a 1394 cable.

#### 9 Playback frame rate display

##### 24P, 24PA, 60P, 30P, 50P, 25P

- The "Variable rate: recording rate" display appears when native recording clips shot by a camera recorder, such as the AG-HVX200 are played back.

Example: 12:24P

12P (for the variable rate recording of clips that are not native recording clips)

- The frame rate is not displayed during the playback of 60i or 50i content.

#### 10 Audio level meter display

During recording or on standby, input level is displayed. During playback, audio level being played back is displayed. The channel level set for the "LEVEL METER" item on the setting menu "DISPLAY SETUP" is displayed.

#### 11 USB HOST display

This display appears while the USB HOST mode is established.

#### 12 Text memo, shot mark displays

These displays appear for about 3 seconds when [USER], to which a shot mark or a text memo has been assigned ahead of time, is pressed and the shot mark or text memo is recorded.

##### MARK ON:

When a shot mark has been added

##### MARK OFF:

When a shot mark has been deleted

##### TEXT MEMO:

When a text memo has been added

##### INVALID:

When shot marks or text memos cannot be added or deleted

#### 13 Information display

The following information is displayed depending on the circumstances.

- Warning displays, error displays
- Displays for mode switching using [USER] (OSD OUTSEL, AUDIO OUT, SLOT SEL, SYS FORMAT, INPUT SELECT, REC FMT(SD), REC FMT(HD))
- Display when [MENU/MODE CHK] is pressed and held (Page 85)

#### 14 Operation status displays

**REC:** Recording

**L-REC:** Loop recording

**PAUSE:** Recording standby

**L-PAUSE:** Loop recording on standby

**A -:** AUTO REC setting display (This is displayed with other recording displays except for in USB HOST mode.)

(Continued on the next page)

## Screen displays (continued)

---

: Normal playback

: Playback pause

**REPEAT** : Repeat playback

**1CLIP** : Single clip playback

**1CLIP R** : Single clip repeat playback

( ):

Rapid forward playback (rapid reverse playback)

( ):

Forward frame feed playback (reverse frame feed playback)

**x** ( **x** ):

Forward variable-speed playback (reverse variable-speed playback)

**CLIP** ( **CLIP** ):

Forward clip feed (reverse clip feed)

### 15 HDD easy playback display

This is displayed during easy playback from the hard drive. When playback performance deteriorates, the display blinks for 3 minutes. When the hard drive is damaged or vibrations are added to the hard drive, the display may become incorrect.

### 16 Repeat playback setting display

This appears when "ON" has been selected for the "REPEAT PLAY" item on the setting menu "PLAYBACK FUNCTIONS".

### 17 Remaining battery charge display

As the remaining charge drops, the display changes in the following sequence: → → → → and .

When the charge is low, "LOW BATTERY" appears on the LCD monitor.

(While the AC adapter is being used, a display other than may appear: this is normal and is not a sign of trouble.)

### 18 Media information displays

The card slots in which P2 cards have been inserted and the basic information on the cards are displayed.

**Lighted:**

Recordable P2 card

**Lighted in green:**

P2 card targeted for recording

**Blinking:**

Card recognition underway

:

No card inserted

**P** : Write-protected card

**F** : No memory remaining

**X** : Card cannot be recognized

**E** : Improperly formatted P2 card (which can be used if it is formatted properly)

### 19 Remaining media memory displays

The amount of memory remaining on the card in the slot targeted for recording is displayed when "ONE CARD" is selected for the "P2CARD REMAIN" item on the setting menu "DISPLAY SETUP". The target slot can be switched to another slot using "SLOT SEL" assigned to [USER]. When "TOTAL" is selected, the total amount of memory remaining on the two cards is displayed.

### 20 Monitor volume level meter

When is pressed, the level of the volume which is output from the speaker and headphone jack is displayed.

You can adjust the volume level using the and buttons.

During variable-speed playback, while holding down [ALT/3], press and button to adjust the volume.

## Major warning displays

This section provides major warning displays which are displayed on the LCD monitor. For other warning displays, check the displayed messages.

### ■ C

#### CANNOT ACCESS!

Data cannot be accessed because of a problem in the content or for some other reason. Restore the media or clips to the normal operating status, and then use the data.

#### CANNOT ACCESS CARD!

An error occurred while accessing the P2 card. Check the P2 card.

#### CANNOT ACCESS TARGET!

An error occurred while accessing the connection destination target. Check the hard drive status and connections.

#### CANNOT DELETE!

Data cannot be deleted because of a mismatch in the content versions. Ensure that the same content version as the device is used.

#### CANNOT FORMAT!

The P2 card cannot be formatted because of a problem. Check the P2 card.

---

**CANNOT RE-CONNECT!**

Clips cannot be reconnected because content which is contained on no more than one card has been selected or because of a similar reason. Check the selected content.

---

**CANNOT RECOGNIZE HDD!**

The connection destination target cannot be recognized correctly. Turn the power of the hard drive off and then back on or change the connected hard drive.

---

**CANNOT REPAIR!**

You thought the clip would be repaired and it was tried to be repaired, but could not actually be repaired. Check the selected clip.

---

**CARD FULL!**

The P2 card or SD card is full. Insert media with free space.

---

**CARD IS EMPTY! CANNOT COPY!**

The P2 card whose data is to be copied is blank. A blank card cannot be copied because there is no data to be copied.

---

**COPY INHIBITED**

The input signals are copy-guarded so they cannot be recorded correctly.

---

**■ D****DIR ENTRY NG CARD**

The directory structure on the P2 card is not supported.

Operation continues. However, back up data on the P2 card as soon as possible, and format the card before using it again.

---

**■ F****FORMAT ERR!**

The card does not comply with the P2 standard.

---

**■ H****HDD CAPACITY FULL!**

The hard drive does not have enough free memory. Use a new hard drive or formatted hard drive since the connection destination target does not have enough remaining memory.

---

**HDD DISCONNECTED!**

The hard drive has been disconnected. Re-establish the USB connection. If the hard drive still fails to operate properly, turn its power off, and then turn it back on.

---

**■ I****INCOMPATIBLE CARD**

The card complies with the different standard and so it cannot be used.

---

**■ L****LACK OF REC CAPACITY!**

There is not enough memory on the card for the clips to be recorded. Insert a card with enough memory on the card for the clips to be recorded.

---

**LOW BATTERY**

No operation is possible because the battery charge is depleted.

---

**■ M****MISMATCH COMPONENT!**

Data cannot be copied because the copy source and copy destination P2 cards have different model numbers. Either use P2 cards of the same model number, or copy data one clip at a time.

---

**MISSING CLIP!**

Shot marks cannot be added to clips that span across multiple cards if all cards are not inserted to the unit's slots. Insert all the cards containing the consecutive clips.

---

**■ N****NO CARD!**

No P2 card or SD card has been inserted. Insert media which is supported.

---

**NO COPY TO SAME CARD!**

Data cannot be copied because the same card is being specified for the copy source and copy destination. Copy the data onto a card which does not contain the selected clip.

---

**NO REPAIR CLIP!**

The clip to be repaired has not been selected.

---

**■ P****P2 CARD IS UNFORMATTED!**

The P2 card has not been formatted. Use a P2 card which has been formatted.

---

**PLEASE FORMAT P2 CARD!**

When importing a partition from a hard disk to a P2 card, only use a freshly formatted P2 card to copy to. After formatting the card using the P2 device, initiate copying again.

---

## Screen displays (continued)

---

### ■ R

---

#### **RUN DOWN CARD**

The maximum number of overwrites on the P2 card has been exceeded.

Operation continues. However, recording or playback may not operate correctly. It is recommended that you replace the P2 card with another one.

### ■ T

---

#### **TOO MANY CLIPS!**

Too many clips have been selected. Reduce the number of clips which have been selected.

#### **TOO MANY PARTITIONS!**

There are too many partitions. The maximum number of partitions available on the hard drive is 23 in the USB HOST mode. Use a new hard drive or formatted hard drive.

#### **TOO MANY TARGETS!**

A multiple number of devices have been connected. Only one USB hard drive must be connected. Make sure if a hub, multi-HDD, etc. are not used. After disconnecting the unnecessary devices, turn the power of the required device off and then turn it back on.

#### **TURN POWER OFF!**

Turn the power off, and turn it back on for use.

### ■ U

---

#### **UNKNOWN CONTENTS FORMAT!**

A contents version mismatches or this is a clip for which the unknown clip indicator is displayed. Match the unit and contents versions.

#### **UNKNOWN DEVICE CONNECTED!**

A DVD drive or other devices which are not supported have been connected. After disconnecting the unnecessary devices, turn the power of the required device off and then turn it back on.

### ■ V

---

#### **VERIFICATION FAILED!**

A mismatch was found by verification after copying. Copy the data again.

### ■ W

---

#### **WRITE PROTECTED!**

The P2 card or SD card is write-protected. Insert media on which data can be saved.

## Error displays

Errors are displayed when trouble has occurred in the unit, P2 card, etc. If the error persists even after turning the power off and back on, depending on what the error message says, replace the card or contact your dealer.

### ■ Number

---

#### **1394 INITIAL ERROR**

(Connection trouble)

There is trouble in the DVCPRO/DV input/output connector (IEEE1394) connection or the signals are not being input or output correctly. Check the connections between the unit and the other device. If the error display is not cleared, turn the power off and then back on.

#### **1394 INPUT ERROR (OTHER FORMAT)**

The input signal format differs from the system format.

### ■ C

---

#### **CANNOT PLAY**

This appears when trouble has occurred during playback.

#### **CARD ERR (1) (2) (1/2)**

(Trouble with the P2 card in the slot corresponding to the number shown)

- If the warning persists, turn off the power.
- If the warning persists even when recording is initiated again, replace the existing card with another one.

### ■ R

---

#### **REC WARNING**

This appears when trouble has occurred during recording. Initiate the recording again. If the warning is still displayed, consult your dealer.

### ■ S

---

#### **SYSTEM ERROR**

This appears in the following abnormal situations.

- This appears when trouble has occurred in the system. Turn the system's power off and then back on.
- This error may appear with some connected hard drives. Check the connected hard drive.

P2 MICON ERROR (no response from P2 microprocessor), P2 CONTROL ERROR (P2 control trouble)

### ■ T

---

#### **TURN POWER OFF**

This appears when trouble has occurred because a card was ejected while its data was being accessed. Turn the system's power off and then back on.



## Selecting what is to be displayed on the screen

The following items appearing on the LCD monitor screen are displayed when [MENU/MODE CHK] is held down or when a setting for the "OTHER DISPLAY" item (Page 103) on the setting menu "DISPLAY SETUP" screen has been selected.

Item displayed	MODE CHECK	OTHER DISPLAY setting	
		ON	OFF
1 Time code displays	✓	—	—
2 Warning information	—	—	—
3 System format displays	✓	✓	x
4 Compressed recording format display	✓	✓	✓
5 System frequency displays	✓	✓	x
6 INPUT LOCK	—	✓	x
7 Squeeze recording display	✓	✓	x
8 Date and time display	✓	—	—
9 Playback frame rate display*	✓	✓	x
10 Audio level meter display	✓	—	—
11 USB HOST display	✓	✓	✓
12 Text memo, shot mark displays	—	—	—
13 Information display	✓	—	—
14 Operation status displays	✓	✓	✓
15 HDD easy playback display	✓	✓	✓
16 Repeat playback setting display	✓	✓	x
17 Remaining battery charge display	✓	—	—
18 Media information displays	✓	—	—
19 Remaining media memory displays	✓	—	—
20 Monitor volume level meter	—	—	—
21 Setting compressed recording format	✓	x	x
22 USER SW	✓	x	x
23 INPUT SELECT	✓	x	x
24 Audio output channel	✓	x	x

✓ : Displayed    x : Not displayed    — : Displayed by another setting

"✓" in the MODE CHECK column indicates the items which are displayed when [MENU/MODE CHK] is held down.

\* The FRAME RATE is not displayed when the 60i format is used.

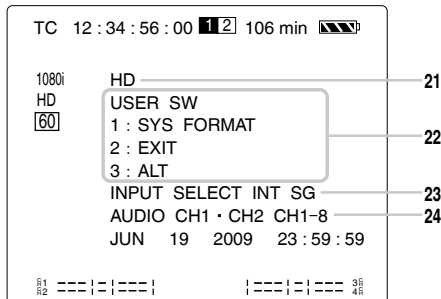

### 21 Setting compressed recording format

The compressed recording format that has been set is displayed. (Page 81)

### 22 USER SW

The functions assigned to USER 1 to 3 on the setting menu "SW MODE" are displayed. (Page 97)

### 23 INPUT SELECT

Input signals for video and audio are displayed. (Page 90)

### 24 Audio output channel

The setting values for "AUDIO OUT" (Page 98) and "SD SDI AUDIO" (Page 101) are displayed from left.

# Recording/output supporting format

## ■ Setting the system frequency

The recording/output format is selected as below by setting the setting menu.

### AG-HPG20 output format (EE/recording)

Setting menu						Recording	Output	Setting menu	Output	Setting menu	Output							
SYSTEM FREQ	SYS FORMAT	REC FMT (SD)	25M REC CH	REC FMT (HD)	INPUT SELECT	Signal recorded on P2 card	1394 signal format AUDIO	SDI SEL	SDI	SD SDI AUDIO	SDI AUDIO packet**1							
59.94Hz /50Hz	1080/60i 1080/50i	-	-	AVC100	SDI INT SG	1080i Audio 8ch	/	AUTO	1080i	-	8ch							
				AVC50				1080i	1080i									
															720P	720p		
															480i/576i	480i, 576i	CH1-8 CH1-4/ CH5-8	8ch 4ch
															AUTO	1080i		8ch
															1080i	1080i	-	(ch5-8 are muted.)
					DVCPRO (DVCPRO HD)	1394			720P	720p		8ch						
									480i/576i	480i, 576i	CH1-8	(ch5-8 are muted.)						
									480i/576i	480i, 576i	CH1-4/ CH5-8	4ch (ch5-8 are muted.)						
									AUTO	720p		8ch						
									1080i	1080i	-	8ch						
									720P	720p		(ch5-8 are muted.)						
								480i/576i	480i, 576i	CH1-8 CH1-4/ CH5-8	8ch 4ch (ch5-8 are muted.)							
								AUTO	720p		8ch							
								1080i	1080i	-	(ch5-8 are muted.)							
								720P	720p		8ch							
								480i/576i	480i, 576i	CH1-8	(ch5-8 are muted.)							
								480i/576i	480i, 576i	CH1-4/ CH5-8	4ch (ch5-8 are muted.)							
								AUTO	480i, 576i	-	4ch							
								1080i	1080i	-	8ch							
								720P	720p	-	(ch5-8 are muted.)							
								480i/576i	480i, 576i	-	4ch							
								AUTO	480i, 576i	-	4ch							
								1080i	1080i	-	(ch3-4 are muted.*2)							
								720P	720p	-	8ch							
								480i/576i	480i, 576i	-	(ch3-8 are muted.)							
								480i/576i	480i, 576i	-	4ch							
								480i/576i	480i, 576i	-	(ch3-4 are muted.*2)							

\*1 When "EMBEDDED AUDIO" is OFF, AUDIO packet is not superimposed.

\*2 When DV signal is input during 1394 input, and the input audio signal is 32kHz/4ch(12Bit), 4ch audio is output.

- 1394 output: AUTO only. AVC-Intra100/AVC-Intra50 are not supported for 1394 input/output.
- Use VIDEO/SDI/1394 output for monitoring purpose in other modes than playback mode. It is not suitable for recording purpose because Pictures/Sound/Time cord (TC/UB) may become incorrect.

**AG-HPG20 output format (during playback)**

Setting menu	Playback	Output	Setting menu	Output	Setting menu	Output
SYSTEM FREQ	Signal recorded on P2 card	1394 signal format AUDIO	SDI SEL	SDI output	SD SDI AUDIO	SDI AUDIO packet*
59.94Hz	1080/59.94i 1080/29.97p over 59.94i (2:2) 1080/23.98p over 59.94i (2:3) 1080/23.98pA over 59.94i (2:3:3:2) 1080/23.98pN 1080/29.97pN	1080/59.94i 8ch	AUTO	1080/59.94i	-	8ch
			1080i	1080/59.94i		
			720P	720/59.94p		
			480i	480/59.94i		
	720/59.94p 720/29.97p over 59.94p (2:2) 720/23.98p over 59.94p (2:3) 720/23.98pN 720/29.97pN	720/59.94p 8ch	AUTO	720/59.94p	-	8ch
			1080i	1080/59.94i		
			720P	720/59.94p		
			480i	480/59.94i		
	480/59.94i 480/29.97p over 59.94i (2:2) 480/23.98p over 59.94i (2:3) 480/23.98pA over 59.94i (2:3:3:2)	480/59.94i 4ch (ch1-4)/ 2ch (ch1-2)	AUTO	480/59.94i	-	4ch (ch1-4)
			1080i	1080/59.94i		8ch
			720P	720/59.94p		(ch5-8 are muted.)
			480i	480/59.94i		4ch (ch1-4)
50Hz	1080/50i 1080/25p over 50i (2:2) 1080/25pN	1080/50i 8ch	AUTO	1080/50i	-	8ch
			1080i	1080/50i		
			720P	720/50p		
			576i	576/50i		
	720/50p 720/25p over 50p (2:2) 720/25pN	720/50p 8ch	AUTO	720/50p	-	8ch
			1080i	1080/50i		
			720P	720/50p		
			576i	576/50i		
	576/50i 576/25p over 50i (2:2)	576/50i 4ch (ch1-4)/ 2ch (ch1-2)	AUTO	576/50i	-	4ch (ch1-4)
			1080i	1080/50i		8ch
			720P	720/50p		(ch5-8 are muted.)
			576i	576/50i		4ch (ch1-4)

- \* When "EMBEDDED AUDIO" is OFF, AUDIO packet is not superimposed.
- 1394 output: AUTO only. AVC-Intra100/AVC-Intra50 are not supported for 1394 input/output.



# Setting menu configuration

## MAIN MENU

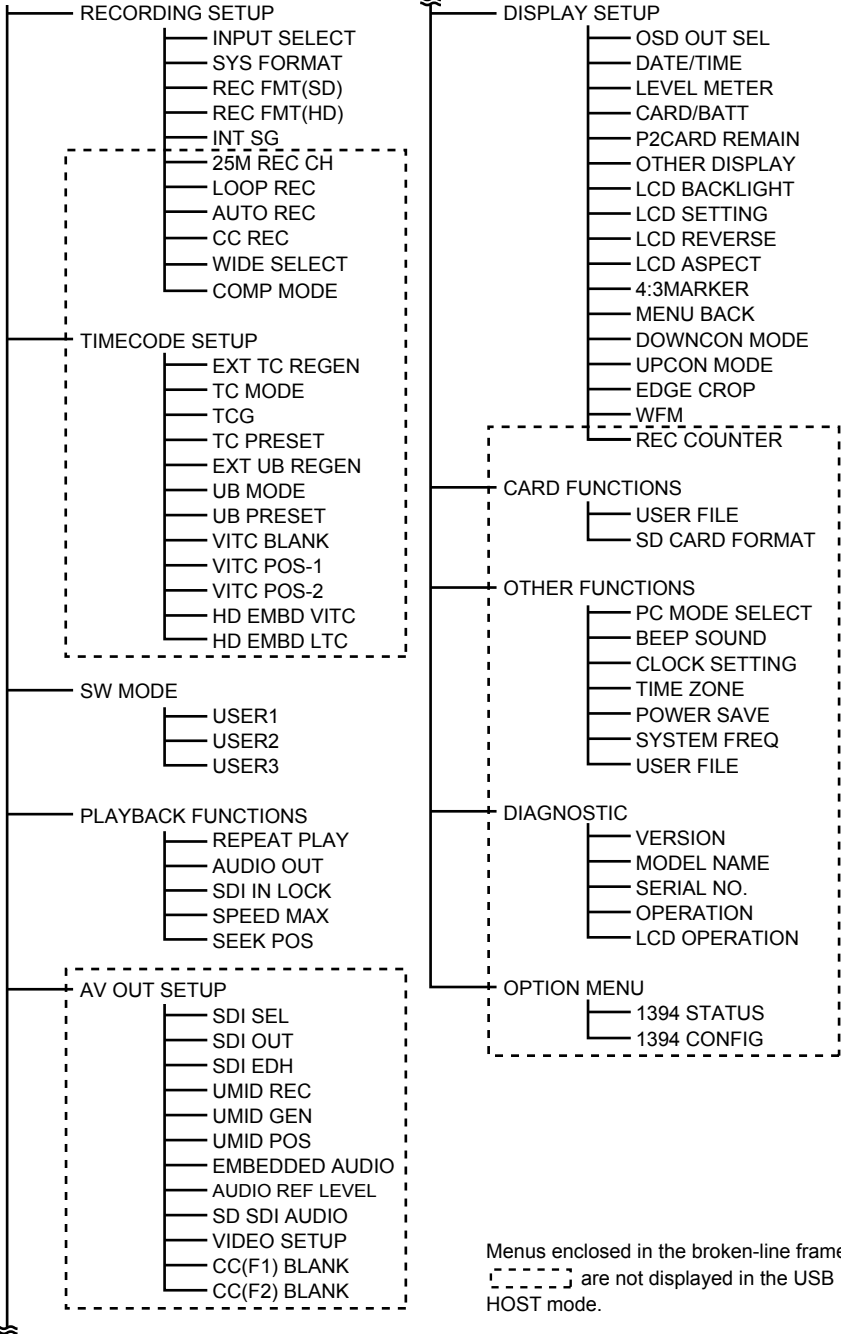

# List of setting menus

## RECORDING SETUP screen

Item	Description of settings
<b>INPUT SELECT</b>	<p>This is used to select the input signals for video and audio.</p> <p><b><u>SDI:</u></b> Set the input signal to SDI.</p> <p>&lt;Note&gt; When the SDI input signal differs from the recording system format, the images are displayed black and sound is muted. Also, TC is not correct. (When the setting menu "SYSTEM FREQ" is set to 59.94 Hz and if exactly 60.00 Hz signal is input, the output image becomes noise, not black.)</p> <p><b>1394:</b> Set the input signal to 1394.</p> <p>&lt;Note&gt;  <ul style="list-style-type: none"> <li>When 1394 is set, additional information such as TC is not output to SDI/VIDEO output during EE/recording.</li> <li>If 1394 is selected while AVC100 or AVC50 is selected on the setting menu "REC FMT(HD)", the setting menu "INT SG" is set to 100%CB on this unit.</li> </ul> </p> <p><b><u>INT SG:</u></b> Set the input signal to the built-in Signal Generator. (Page 91) Audio is set at 1kHz of standard level.</p>
<b>SYS FORMAT</b>	<p>This is used to set the unit's recording system format. (When 59.94 Hz has been set)</p> <p><b><u>1080/60i:</u></b> Set 1080/60i as a recording system format.</p> <p><b>720/60P:</b> Set 720/60p as a recording system format.</p> <p><b>480/60i:</b> Set 480/60i as a recording system format.</p> <p>(When 50 Hz has been set)</p> <p><b><u>1080/50i:</u></b> Set 1080/50i as a recording system format.</p> <p><b>720/50P:</b> Set 720/50p as a recording system format.</p> <p><b>576/50i:</b> Set 576/50i as a recording system format.</p>
<b>REC FMT(SD)</b>	<p>This is used to set the compressed recording format when "SYS FORMAT" has been set to 480/60i or 576/50i.</p> <p><b><u>50M:</u></b> Set DVCPRO50 as a compressed recording format.</p> <p><b>25M:</b> Set DVCPRO as a compressed recording format.</p> <p><b>DV:</b> Set DV as a compressed recording format.</p>
<b>REC FMT(HD)</b>	<p>This is used to set the compressed recording format when "SYS FORMAT" has been set to 1080/60i or 720/60P, 1080/50i or 720/50P.</p> <p><b><u>DVCPRO:</u></b> Set DVCPRO HD as a compressed recording format.</p> <p><b>AVC50:</b> Set AVC-Intra50 as a compressed recording format.</p> <p><b><u>AVC100:</u></b> Set AVC-Intra100 as a compressed recording format.</p>

\_\_\_\_ The underlined settings are the factory mode settings.

## RECORDING SETUP screen (continued)

Item	Description of settings
<b>INT SG</b>	<p>This is used to set the type of built-in signal. In SD mode, SMPTE signal and ARIB signal are set to BLACK.</p> <p><b>100%CB:</b> 100% color bar  <b>75%CB:</b> 75% color bar  <b>SMPTE:</b> SMPTE color bar  <b>ARIB:</b> ARIB color bar  <b>BLACK:</b> black</p>
<b>25M REC CH</b>	<p>This is used to set the number of audio channels for recording in DVCPRO (25M) or DV compressed recording format.</p> <p><b>2CH:</b>  Record in 2-channel.  <b>4CH:</b>  Record in 4-channel.  &lt;Note&gt;  When 1394 input signal is selected, the same number of audio channel as that of audio channel of 1394 input signal at the start of recording is recorded regardless of setting made as above.</p>
<b>LOOP REC</b>	<p>This is used to select whether to perform LOOP REC or not.</p> <p><b>ON:</b>  Perform LOOP REC.  <b>OFF:</b>  Not perform LOOP REC.  &lt;Note&gt;  This is set to OFF when the power is turned on again.</p>
<b>AUTO REC</b>	<p>This is used to select whether to perform AUTO REC/STOP according to the recording/stop signal of HD-SDI input signal sent from the camera recorder.</p> <p><b>OFF:</b>  Not perform AUTO REC/STOP.  <b>TYPE1:</b>  Perform AUTO REC/STOP according to the Recording Mark in LTC information added to HD-SDI.  <b>TYPE2:</b>  Perform AUTO REC/STOP according to the Recording Mark in SVITC information added to HD-SDI.  <b>TYPE3:</b>  This is selected when non-Panasonic camera recorders are used.  &lt;Note&gt;</p> <ul style="list-style-type: none"> <li>• When selecting TYPE1 or TYPE2, refer to “Panasonic camera recorder, recording format and Recording Mark” (Page 92).</li> <li>• The devices supporting TYPE3 are Sony Corporation’s HDW-F900R and PDW-700. (Confirmed in November, 2008)</li> </ul>

\_\_\_ The underlined settings are the factory mode settings.

HDW-F900R and PDW-700 are registered trademarks of Sony Corporation.

## List of setting menus (continued)

### RECORDING SETUP screen (continued)

Item	Description of settings
<b>CC REC</b>	<p>Only when 59.94 Hz has been set</p> <p>This is used to select whether to record closed caption signals superimposed onto SD-SDI input signals.</p> <p><b>ON:</b> Record closed caption signals.</p> <p><b>OFF:</b> Not record closed caption signals.</p> <p>&lt;Note&gt; When 1394 has been selected as an input signal, the closed caption signals superimposed onto the input signal is recorded regardless of what setting is made on this menu.</p>

\_\_\_ The underlined settings are the factory mode settings.

### Panasonic camera recorder, recording format and Recording Mark

Model	Recording format	Recording Mark Type	Remarks
AJ-HDC27F, H	720/24p over 60p	TYPE1	–
AJ-HDX400P	1080/59.94i	–*	Possible to switch to TYPE1/TYPE2. For operations, refer to the operating instructions of Panasonic's camera recorder.
AJ-HDX400E	1080/50i	–*	
	AJ-HDX900	1080/25p over 50i	–*
720/59.94p		TYPE1	
720/23.98p over 59.94p		TYPE1	
720/29.97p over 59.94p		TYPE1	
1080/59.94i		–*	
1080/23.98p over 59.94i		TYPE2	
1080/29.97p over 59.94i		–*	
1080/50i		–*	
1080/25p over 50i		–*	
AJ-HDX900	720/50p	TYPE1	–
	720/50p over 50p	TYPE1	
AG-HPX500 AJ-HPX2000/2100 AJ-HPX3000 AJ-HPX2700 AJ-HPX3700 AG-HPX170/171 AG-HPX300/301	720p	TYPE1, 2	–
	1080i	TYPE2	–

\* In the initial setting, Recording Mark has not been superimposed onto the HD-SDI signals.



## RECORDING SETUP screen (continued)

Item	Description of settings
<b>WIDE SELECT</b>	<p>This is used to set whether to record WIDE information when the setting menu "SYS FORMAT" has been set to 480/60i or 576/50i.</p> <p><b>WIDE:</b> Record  <b>NORMAL:</b> Not record</p> <p>&lt;Note&gt;            When 1394 input has been selected on the setting menu "INPUT SELECT", the input signal information is recorded.</p>
<b>COMP MODE</b>	<p>Selects the compression method used during video recording.</p> <p><b>DARK:</b>            Records video suppressing compression video distortion that is generated by dark areas that are about 10 IRE (70 mV) or less.</p> <p><b>NORMAL:</b>            Records using normal compression processing.</p> <p>&lt;Note&gt;            DARK setting becomes effective when the following conditions are all satisfied.</p> <ul style="list-style-type: none"> <li>• The setting menu "SYS FORMAT" is set to 720/60P or 720/50P.</li> <li>• The setting menu "REC FMT (HD)" is set to DVCPRO.</li> <li>• The setting menu "INPUT SELECT" is set to SDI or INT SG.</li> </ul>

## TIMECODE SETUP screen

Item	Description of settings
<b>EXT TC REGEN</b>	<p>This is used to select whether to clone the incoming time code, or generate new time code using the unit's time code generator.</p> <p><b>ON:</b>            The time code of the external input signal selected on the setting menu "INPUT SELECT" is recorded.</p> <ul style="list-style-type: none"> <li>• HD-SDI input: SLTC</li> <li>• SD-SDI input: VITC</li> <li>• 1394 input: 1394 input time code information</li> </ul> <p><b>OFF:</b>            The data is recorded using the time code set on the setting menu "TC MODE" or "TCG".</p> <p>&lt;Note&gt;            When this item has been set to ON, it takes priority over the "TC MODE" or "TCG".</p>
<b>TC MODE</b> (Only when 59.94 Hz has been set)	<p>This is used to select the time code compensation mode when recording the time codes of the internal time code generator. You need to set the setting menu "EXT TC REGEN" to "OFF".</p> <p><b>DF:</b> The drop frame mode is used.  <b>NDF:</b> The non-drop frame mode is used.</p>
<b>TCG</b>	<p>This is used to set the operation mode for running the time code of the internal time code generator. You need to set the setting menu "EXT TC REGEN" to "OFF".</p> <p><b>FREE RUN:</b>            The time code runs no matter what operating mode is established.</p> <p><b>REC RUN:</b>            The time code runs only during recording.</p>
<b>TC PRESET</b>	<p>This is used to set the initial value of the time code to be recorded. You need to set the setting menu "EXT TC REGEN" to "OFF".</p>

<Note>

When clips recorded with 24pN or 24PA signal are fed frame by frame, the lost TC values (not consecutive TC values) are output.

\_\_\_ The underlined settings are the factory mode settings.

## List of setting menus (continued)

### TIMECODE SETUP screen (continued)

Item	Description of settings
<b>EXT UB REGEN</b>	<p>This is used to select whether to clone the incoming user's bit information, or generate new user's bit information.</p> <p><b>ON:</b> The signals are recorded using the user's bit of the external input signal selected on the setting menu "INPUT SELECT".</p> <p><b>OFF:</b> The signals are recorded using the user's bit selected on the setting menu "UB MODE".</p> <p>&lt;Note&gt; When this item has been set to ON, it takes priority over the setting menu "UB MODE".</p>
<b>UB MODE</b>	<p>This is used to set what is to be recorded as the user's bit. "OFF" must be selected for the "EXT UB REGEN" item setting. (Page 66)</p> <p><b>USER:</b> The user information is recorded.</p> <p><b>TIME:</b> The time of the recording is recorded.</p> <p><b>DATE:</b> The date/time of the recording are recorded.</p> <p><b>TCG:</b> The value generated by the time code generator is recorded.</p> <p><b>FRM. RATE:</b> The information of the frame rate after frame conversion is recorded.</p> <pre>   * * 0 * * * *                    a   b   c   d </pre> <p><b>a: Information on the verification of the user's bit value</b></p> <p><b>b: Frame sequence number</b></p> <ul style="list-style-type: none"><li>• "F" is displayed in 60i/30p or 50i/25p mode.</li></ul> <p><b>c: Frame rate information</b></p> <ul style="list-style-type: none"><li>• Frame rate (60, 30, 24, 50 or 25)</li><li>• I/P identification information</li><li>• Conversion information</li><li>• Frame rate factor</li></ul> <p><b>d: Recording control information</b></p> <ul style="list-style-type: none"><li>• Updated frame information</li><li>• REC START/STOP information</li></ul> <p>&lt;Note&gt; <b>When playing back native recorded clips</b> To set the SDI or 1394 output user's bit as the frame rate information, select FRM. RATE for this setting, and play back the clips.</p>
<b>UB PRESET</b>	<p>This is used to set the user's bit. "OFF" must be selected for the "EXT UB REGEN" item setting and "USER" must be selected for the "UB MODE" item setting. (Page 66)</p>

\_\_\_ The underlined settings are the factory mode settings.

## TIMECODE SETUP screen (continued)

Item	Description of settings
<b>VITC BLANK</b>	<p>This is used during playback to set whether to output VITC signal to the position set on the setting menu "VITC POS-1" or "VITC POS-2".</p> <p><b>BLANK:</b> Not output</p> <p><b>THRU:</b> Output</p> <p>&lt;Note&gt;</p> <p>This setting is effective only for VIDEO output and SD-SDI output.</p>
<b>VITC POS-1</b>	<p>This is used to set the insert position of VITC signal.</p> <p>(When 59.94 Hz has been set)</p> <p><b>10L</b>  </p> <p><u><b>16L</b></u>  </p> <p><b>20L</b></p> <p>(When 50Hz has been set)</p> <p><b>7L</b>  </p> <p><u><b>11L</b></u>  </p> <p><b>22L</b></p> <p>&lt;Note&gt;</p> <ul style="list-style-type: none"> <li>You cannot select the same line as the lines for "VITC POS-2" on the "TIMECODE SETUP" screen or "UMID POS" on the "AV OUT SETUP" screen.</li> <li>This setting is effective only for VIDEO output and SD-SDI output.</li> </ul>

## List of setting menus (continued)

### TIMECODE SETUP screen (continued)

Item	Description of settings
<b>VITC POS-2</b>	<p>This is used to set the insert position of VITC signal. (When 59.94 Hz has been set)</p> <p><b>10L</b>   <u><b>18L</b></u>   <b>20L</b></p> <p>(When 50Hz has been set)</p> <p><b>7L</b>   <u><b>13L</b></u>   <b>22L</b></p> <p>&lt;Note&gt;</p> <ul style="list-style-type: none"> <li>• You cannot select the same line as the lines for "VITC POS-1" on the "TIMECODE SETUP" screen or "UMID POS" on the "AV OUT SETUP" screen.</li> <li>• This setting is effective only for VIDEO output and SD-SDI output.</li> </ul>
<b>HD EMBD VITC</b>	<p>This is used to set whether to superimpose the VITC information onto HD-SDI output or not.</p> <p><b>ON:</b> Superimpose</p> <p><b>OFF:</b> Not superimpose</p>
<b>HD EMBD LTC</b>	<p>This is used to set whether to superimpose the LTC information onto HD-SDI output or not.</p> <p><b>ON:</b> Superimpose</p> <p><b>OFF:</b> Not superimpose</p>

\_\_\_\_ The underlined settings are the factory mode settings.

## SW MODE screen

Item	Description of settings
<b>USER1</b>	<p>This is used to set which function is to be assigned to the USER1 button.</p> <p><b>INPUT SEL:</b> Input signal setting (Page 90)</p> <p><b>SYS FORMAT:</b> The system format is selected. (Page 90)</p> <p><b>REC FMT/SD:</b> The recording format for SD is selected. (Page 90)</p> <p><b>REC FMT/HD:</b> The recording format for HD is selected. (Page 90)</p> <p><b>SHOT MARK:</b> A shot mark is recorded on the clip. (Page 54)</p> <p><b>TEXT MEMO:</b> A text memo is recorded. (Page 60)</p> <p><b>LCD BL:</b> LCD backlight setting (Page 103)</p> <p><b>OSD OUTSEL:</b> The OSD/GUI/WFM output destination is set. (Page 103)</p> <p><b>AUDIO OUT:</b> AUDIO OUT selection. (Page 98)</p> <p><b>SLOT SEL:</b> The P2 card slot for recording is switched. (Page 64)</p> <p><b>LCD RVS:</b> LCD reverse setting (Page 104)</p> <p><b>WFM:</b> Waveform monitor (Page 64)</p> <p><b>ONE CLIP:</b> Single clip playback is performed. (Page 58)</p>
<b>USER2</b>	<p>This is used to set which function is assigned to "EXIT/2". The following function can be assigned in addition to the USER1 items.</p> <p><b>EXIT:</b> EXIT function is activated.</p>
<b>USER3</b>	<p>This is used to set which function is assigned to "ALT/3". The following function can be assigned in addition to the USER1 items.</p> <p><b>ALT:</b> ALT function is activated.</p>

\_\_\_ The underlined settings are the factory mode settings.

## List of setting menus (continued)

### PLAYBACK FUNCTIONS screen

Item	Description of settings
<b>REPEAT PLAY</b>	<p>This is used to set repeat playback. (Page 59)</p> <p><b>ON:</b> After playing back the last clip, the first clip is played back in succession.</p> <p><b>OFF:</b> After playing back the last clip, playback stops.</p> <p>&lt;Note&gt;</p> <ul style="list-style-type: none"> <li>• Repeat playback is not performed when playing back from the bottom of the text memo screen.</li> <li>• If a P2 card is ejected during repeat playback, playback stops when the clip on the ejected P2 card is reached.</li> <li>• If a P2 card is inserted during repeat playback, the clips on the inserted P2 card will be played back when repeat playback is next performed.</li> </ul>
<b>AUDIO OUT</b>	<p>This is used to set the audio signals to be output from the AUDIO OUT connectors (pin jacks), speaker and headphone jack.</p> <p><u><b>CH1 - CH2:</b></u> CH1 connector = CH1 signal, CH2 connector = CH2 signal</p> <p><b>CH1:</b> CH1 connector = CH1 signal, CH2 connector = CH1 signal</p> <p><b>CH2:</b> CH1 connector = CH2 signal, CH2 connector = CH2 signal</p> <p><u><b>CH3 - CH4:</b></u> CH1 connector = CH3 signal, CH2 connector = CH4 signal</p> <p><b>CH3:</b> CH1 connector = CH3 signal, CH2 connector = CH3 signal</p> <p><b>CH4:</b> CH1 connector = CH4 signal, CH2 connector = CH4 signal</p> <p><u><b>CH5 - CH6:</b></u> CH1 connector = CH5 signal, CH2 connector = CH6 signal</p> <p><b>CH5:</b> CH1 connector = CH5 signal, CH2 connector = CH5 signal</p> <p><b>CH6:</b> CH1 connector = CH6 signal, CH2 connector = CH6 signal</p> <p><u><b>CH7 - CH8:</b></u> CH1 connector = CH7 signal, CH2 connector = CH8 signal</p> <p><b>CH7:</b> CH1 connector = CH7 signal, CH2 connector = CH7 signal</p> <p><b>CH8:</b> CH1 connector = CH8 signal, CH2 connector = CH8 signal</p>

\_\_\_\_ The underlined settings are the factory mode settings.

## PLAYBACK FUNCTIONS screen (continued)

Item	Description of settings
<b>SDI IN LOCK</b>	<p>This is used to select whether the P2 playback output signal is locked (synchronized) to the SDI input signals.</p> <p><b>INT:</b> It is not locked (synchronized).</p> <p><b>INPUT:</b> When the SDI input signal is present, it is locked (synchronized) to the input signal. It is not locked (synchronized) when the input signal is not present.</p> <p>&lt;Note&gt; When SDI is set on the setting menu "INPUT SELECT" and the same SDI input signal as the one set on the setting menu "SYS FORMAT" is input, the output signal is locked (synchronized) to the SDI input signal in EE/recording condition regardless of the setting for the setting menu "SDI IN LOCK".</p>
<b>SPEED MAX</b>	<p>This is used to set the maximum speed of the variable-speed playback and rapid forward/rapid reverse playback.</p> <p><b>X32:</b> 32x speed <b>X60:</b> 60x speed <b>X100:</b> 100x speed</p>
<b>SEEK POS</b>	<p>When using the navigation buttons to jump to the next clip, this menu item controls whether the unit will jump to the beginning of the next clip, or to the next text memo position.</p> <p><b>CLIP:</b> The beginning of the clip <b>CLIP&amp;TMEMO:</b> The beginning of the clip and text memo setting point</p>

## AV OUT SETUP screen

Item	Description of settings
<b>SDI SEL</b>	<p>This is used to set the video signal output from HD/SD-SDI OUT connector. (When the 59.94 Hz system format is set)</p> <p><b>AUTO:</b> The output is automatically switched according to the clip format during playback. The output is automatically switched according to the setting menu "SYS FORMAT" during situations other than playback.</p> <p><b>1080i:</b> 1080/59.94i <b>720P:</b> 720/59.94p <b>480i:</b> 480/59.94i</p> <p>(When the 50 Hz system format is set)</p> <p><b>AUTO:</b> The output is automatically switched according to the clip format during playback. The output is automatically switched according to the setting menu "SYS FORMAT" during situations other than playback.</p> <p><b>1080i:</b> 1080/50i <b>720P:</b> 720/50p <b>576i:</b> 576/50i</p>
<b>SDI OUT</b>	<p>This is used to set the SDI output.</p> <p><b>ON:</b> SDI signals are output. <b>OFF:</b> SDI signals are not output.</p>
<b>SDI EDH</b>	<p>This is used to set whether to superimpose error detection handling (EDH) when SD-SDI signals are output.</p> <p><b>ON:</b> EDH is superimposed. <b>OFF:</b> EDH is not superimposed.</p>

\_\_\_ The underlined settings are the factory mode settings.

## List of setting menus (continued)

### AV OUT SETUP screen (continued)

Item	Description of settings
<b>UMID REC</b>	This is used to set whether to record UMID information. <b>ON:</b> Record <b>OFF:</b> Not record
<b>UMID GEN</b>	This is used to set the creation method of UMID information to be recorded when the setting menu "UMID REC" is set to "ON". <b>INT:</b> The newly created UMID information is always recorded. <b>EXT:</b> The UMID information superimposed onto the input signals is always recorded. The newly created UMID information is recorded when the information is not superimposed onto the input signal.
<b>UMID POS</b>	This is used to set the line on which the UMID information is superimposed. <b>BLANK</b> <b>12L</b>   <u><b>17L</b></u>   <b>19L</b> <Note> <ul style="list-style-type: none"> <li>• You cannot select the same line as the lines for "VITC POS-1", "VITC POS-2" on the "TIMECODE SETUP" screen.</li> <li>• When playing back the native clip in DVCPRO HD format, UMID has NO-INFO.</li> </ul>

\_\_\_\_ The underlined settings are the factory mode settings.



## AV OUT SETUP screen (continued)

Item	Description of settings
<b>EMBEDDED AUDIO</b>	This is used to set whether to superimpose the audio data onto HD-SDI output and SD-SDI output. <u><b>ON:</b></u> Superimpose <b>OFF:</b> Not superimpose
<b>AUDIO REF LEVEL</b>	This is used to set the normal level. <b>(AG-HPG20P)</b> <u><b>FS-20:</b></u> -20dB <b>FS-18:</b> -18dB <b>FS-12:</b> -12dB  <b>(AG-HPG20E)</b> <u><b>FS-20:</b></u> -20dB <b>FS-18:</b> -18dB <b>FS-12:</b> -12dB
<b>SD SDI AUDIO</b>	This is used to select the audio channel which is superimposed onto SD-SDI when HD signal is down-converted and output as SD-SDI signal. <u><b>CH1-4:</b></u> CH1-4 is output to CH1-4. <b>CH5-8:</b> CH5-8 is output to CH1-4. <b>CH1-8:</b> CH1-8 is output to CH1-8.
<b>VIDEO SETUP</b> (This item is displayed only when 59.94 Hz is set)	The setup level of the video signals during playback is set. <u><b>0%:</b></u> 0% is set as the output setup level. <b>7.5%:</b> 7.5% is set as the output setup level.

\_\_\_ The underlined settings are the factory mode settings.

## List of setting menus (continued)

### AV OUT SETUP screen (continued)

Item	Description of settings
<b>CC(F1) BLANK</b>	Only when 59.94 Hz has been set This is used to make ON/OFF setting of the closed caption signal in the first field output from SD-SDI output and VIDEO output. <b>BLANK:</b> Forced blanking <b>THRU:</b> Output <Note> In recording/recording standby status, the closed caption signals superimposed onto the input signals are output.
<b>CC(F2) BLANK</b>	Only when 59.94 Hz has been set This is used to make ON/OFF setting of the closed caption signal in the second field output from SD-SDI output and VIDEO output. <b>BLANK:</b> Forced blanking <b>THRU:</b> Output <Note> In recording/recording standby status, the closed caption signals superimposed onto the input signals are output.

\_\_\_\_ The underlined settings are the factory mode settings.

## DISPLAY SETUP screen

Item	Description of settings
<b>OSD OUT SEL</b>	<p>This is used to select to output the information displayed on the LCD monitor to the video output signal and SDI output signal.</p> <p><b>LCD:</b> The information is displayed only on the LCD monitor.</p> <p><b>LCD-VIDEO:</b> The information is displayed both on the LCD monitor and VIDEO output.</p> <p><b>ALL:</b> The information is displayed on the LCD monitor, VIDEO output and SDI output.</p> <p>&lt;Note&gt;</p> <ul style="list-style-type: none"> <li>• When the setting menu "WFM" is set to "OFF", WFM is not output.</li> <li>• When OSD OUT SEL is set for [USER] on the setting menu "SW MODE", the output destination of information circulates as follows according to the setting value for this item.</li> </ul> <p><b>For LCD:</b> LCD monitor → LCD monitor... (Not circulate)</p> <p><b>For LCD-VIDEO:</b> LCD monitor → LCD monitor and VIDEO output → LCD monitor...</p> <p><b>For ALL:</b> LCD monitor → LCD monitor and VIDEO output → LCD monitor, VIDEO output and SDI output → LCD monitor...</p> <ul style="list-style-type: none"> <li>• Even when the output destination of information is switched on [USER], the "OSD OUT SEL" setting value remains the same.</li> </ul>
<b>DATE/TIME</b>	<p>This is used to select the setting for displaying the date and time on the LCD monitor.</p> <p><b>TIME:</b> The time is displayed.</p> <p><b>DATE:</b> The date is displayed.</p> <p><b>TIME&amp;DATE:</b> The date and time are displayed.</p> <p><b>OFF:</b> The date and time are not displayed.</p>
<b>LEVEL METER</b>	<p>This is used to set the audio level meter display to ON or OFF.</p> <p><b>CH1-4:</b> The audio from CH1 to CH4 is displayed.</p> <p><b>CH5-8:</b> The audio from CH5 to CH8 is displayed.</p> <p><b>OFF:</b> No display</p>
<b>CARD/BATT</b>	<p>This is used to set the display of the amount of memory remaining on the card and charge level remaining in the battery to ON or OFF.</p> <p><b>ON:</b> Display</p> <p><b>OFF:</b> No display</p> <p>&lt;Note&gt;</p> <p>As the remaining charge drops, the amount of remaining memory is displayed even if this menu item is set to off.</p>
<b>P2CARD REMAIN</b>	<p>This is used to set how the display of the amount of memory remaining on the P2 card is to be calculated.</p> <p><b>ONE-CARD:</b> The amount of memory remaining on the P2 card in the selected slot is calculated.</p> <p><b>TOTAL:</b> The amount of memory remaining on the P2 cards in both slots is calculated.</p>
<b>OTHER DISPLAY</b>	<p>This is used to set the information to be displayed on the LCD monitor. (Page 85)</p> <p><b>ON:</b> All display</p> <p><b>OFF:</b> No display</p>
<b>LCD BACKLIGHT</b>	<p>This is used to adjust the backlight of the LCD monitor. The backlight becomes brighter than usual when HIGH is selected.</p> <p><b>HIGH:</b> The level of brightness of the LCD monitor is set as HIGH.</p> <p><b>NORMAL:</b> The level of brightness of the LCD monitor is set as NORMAL.</p>

\_\_\_ The underlined settings are the factory mode settings.

## List of setting menus (continued)

### DISPLAY SETUP screen (continued)

Item	Description of settings
<b>LCD SETTING</b>	<p>This is used to adjust the display level of the images on the LCD monitor. (Page 26)</p> <p><b>RETURN:</b> No adjustment  <b>CHANGE:</b> Adjusted</p> <p><b>LCD COLOR LEVEL</b>  <b>LCD BRIGHTNESS</b>  <b>LCD CONTRAST</b></p> <p>&lt;Note&gt;            Note that if you set all LCD adjustment values to minimum, the menu screen will become difficult to see.</p>
<b>LCD REVERSE</b>	<p>This is used to set the function for reversing the top/bottom and left/right of the images displayed on the LCD monitor.</p> <p><b>NORMAL:</b> The images are displayed normally.  <b>REVERSE:</b> The images are displayed with their top/bottom and left/right reversed.</p> <p>&lt;Note&gt;            When REVERSE is set, the direction in which the menu highlighting moves and the direction of the cursor movement on the thumbnail display screen can be reversed in the up/down or left/right direction.</p>
<b>LCD ASPECT</b>	<p>This is used to select the aspect ratio for the LCD monitor when displaying clips in SD format.</p> <p><b>AUTO:</b>            The aspect ratio is automatically selected based on the input signal, information of the signal etc. recorded on the P2 card.  <b>4:3:</b> The aspect ratio is fixed at 4:3.</p> <p>&lt;Note&gt;            When images are displayed with the 16:9 aspect ratio, black bands appear at the top and bottom of the screen. No parts of the images are missing.</p>
<b>4:3MARKER</b>	<p>This is used to set whether to display 4:3 marker on the LCD monitor.</p> <p><b>ON:</b> Display  <b>OFF:</b> No display</p>
<b>MENU BACK</b>	<p>This is used to reduce the transmittance of the background behind the menu display screen so that the menu characters can be seen more easily.</p> <p><b>ON:</b> The background transmittance is reduced.</p> <ul style="list-style-type: none"> <li>• This transmittance is not reduced while "LCD SETTING" on the setting menu "DISPLAY SETUP" is being set.</li> </ul> <p><b>OFF:</b> The background transmittance is 100 %.</p>
<b>DOWNCON MODE</b>	<p>This is used to select the aspect ratio for down-conversion to SD-SDI output and VIDEO output.</p> <p><b>SIDE CROP:</b>            The magnification is changed while matching the input size to the output size along the vertical axis. (The aspect ratio is unchanged.)</p> <p><b>LETTER BOX:</b>            The magnification is changed while matching the input size to the output size along the horizontal axis. (The aspect ratio is unchanged.)</p> <p><b>SQUEEZE:</b>            The magnification is changed while matching the input size to the output size along the horizontal and vertical axis. (The aspect ratio may be distorted.)</p>

\_\_\_\_ The underlined settings are the factory mode settings.

## DISPLAY SETUP screen (continued)

Item	Description of settings
<b>UPCON MODE</b>	<p>This is used to select the aspect ratio for up-conversion to HD-SDI output.</p> <p><b>S-PANEL:</b> The magnification is changed while matching the input size to the output size along the vertical axis. (The aspect ratio is unchanged.)</p> <p><b>CROP:</b> The magnification is changed while matching the input size to the output size along the horizontal axis. (The aspect ratio is unchanged.)</p> <p><b>STRETCH:</b> The magnification is changed while matching the input size to the output size along the horizontal and vertical axis. (The aspect ratio may be distorted.)</p>
<b>EDGE CROP</b>	<p>This is used to set the cutting position of down-converted SD-SDI output and VIDEO output images when the setting menu "DOWNCON MODE" is set to "SIDE CROP".</p> <p><b>-120 ~ 0 ~ +120</b></p> <p>&lt;Note&gt; LCD monitor remains in "LETTER BOX" size.</p>
<b>WFM</b>	<p>This is used to switch the display of the waveform monitor.</p> <p><b>OFF:</b> No display</p> <p><b>WAVE:</b> Wave shape display</p> <p><b>VECTOR:</b> Vector display</p> <p>When WFM is assigned to [USER], the setting value circulates as follows.</p> <ul style="list-style-type: none"> <li>• When the WFM setting value is OFF: OFF → WAVE → VECTOR → OFF...</li> <li>• When the WFM setting value is WAVE: OFF → WAVE → OFF...</li> <li>• When the WFM setting value is VECTOR: OFF → VECTOR → OFF...</li> </ul> <p>&lt;Note&gt; Even when the WFM display is switched on [USER], the "WFM" setting value remains the same.</p>
<b>REC COUNTER</b>	<p>This is used to select the counter operation during recording.</p> <p><b>TOTAL:</b> Counting continues until it is reset on [RESET].</p> <p><b>CLIP:</b> The counter is reset when the shooting starts, then counts the time of the shooting unit.</p> <p>&lt;Note&gt; This is displayed only during recording standby or recording.</p>

## CARD FUNCTIONS screen

Item	Description of settings
<b>USER FILE</b>	Up to 4 sets of setting values on the setting menu can be saved on the SD card. Titles can be given to the files which have been saved. (Page 34)
<b>SD CARD FORMAT</b>	This is used to format SD cards. (Page 33)

\_\_\_ The underlined settings are the factory mode settings.

## List of setting menus (continued)

### OTHER FUNCTIONS screen

Item	Description of settings																																																																																																												
<b>PC MODE SELECT</b>	This is used to select the data transfer mode. <b>USB HOST:</b> USB-connected HDD can be controlled. <b>USB DEVICE:</b> Recognizable from a PC connected via USB																																																																																																												
<b>BEEP SOUND</b>	This is used to set the beep sound to ON or OFF. (Page 109) <b>ON:</b> The beep sound is output <b>OFF:</b> The beep sound is not output <Note> The sound from the output connectors is muted when beeps are sounded.																																																																																																												
<b>CLOCK SETTING</b>	This is used to set the unit's internal calendar. (Page 27)																																																																																																												
<b>TIME ZONE</b>	The time is set in 30-minute increments from 12:00 hours behind GMT to 13:00 hours ahead of GMT (Note that + 12:30 cannot be set, but + 12:45 can be set.). (Refer to the table below.) <b><u>0:00</u></b> <table border="1" data-bbox="338 628 983 1342"> <thead> <tr> <th>Time difference (from GMT)</th> <th>Region (city)</th> <th>Time difference (from GMT)</th> <th>Region (city)</th> </tr> </thead> <tbody> <tr><td>00:00</td><td>Greenwich</td><td>- 00:30</td><td></td></tr> <tr><td>- 01:00</td><td>Azores</td><td>- 01:30</td><td></td></tr> <tr><td>- 02:00</td><td>Central Atlantic</td><td>- 02:30</td><td></td></tr> <tr><td>- 03:00</td><td>Buenos Aires</td><td>- 03:30</td><td>Newfoundland</td></tr> <tr><td>- 04:00</td><td>Halifax (Nova Scotia)</td><td>- 04:30</td><td></td></tr> <tr><td>- 05:00</td><td>New York</td><td>- 05:30</td><td></td></tr> <tr><td>- 06:00</td><td>Chicago</td><td>- 06:30</td><td></td></tr> <tr><td>- 07:00</td><td>Denver</td><td>- 07:30</td><td></td></tr> <tr><td>- 08:00</td><td>Los Angeles</td><td>- 08:30</td><td></td></tr> <tr><td>- 09:00</td><td>Alaska</td><td>- 09:30</td><td>Marquesas Islands</td></tr> <tr><td>- 10:00</td><td>Hawaii</td><td>- 10:30</td><td></td></tr> <tr><td>- 11:00</td><td>Midway Islands</td><td>- 11:30</td><td></td></tr> <tr><td>- 12:00</td><td>Kwajalein Atoll</td><td>+ 11:30</td><td>Norfolk Islands</td></tr> <tr><td>+ 13:00</td><td></td><td>+ 10:30</td><td>Lord Howe Island</td></tr> <tr><td>+ 12:00</td><td>New Zealand</td><td>+ 09:30</td><td>Darwin Islands</td></tr> <tr><td>+ 11:00</td><td>Solomon Islands</td><td>+ 08:30</td><td></td></tr> <tr><td>+ 10:00</td><td>Guam</td><td>+ 07:30</td><td></td></tr> <tr><td>+ 09:00</td><td>Tokyo</td><td>+ 06:30</td><td>Rangoon</td></tr> <tr><td>+ 08:00</td><td>Beijing</td><td>+ 05:30</td><td>Mumbai (Bombay)</td></tr> <tr><td>+ 07:00</td><td>Bangkok</td><td>+ 04:30</td><td>Kabul</td></tr> <tr><td>+ 06:00</td><td>Dhaka</td><td>+ 03:30</td><td>Teheran</td></tr> <tr><td>+ 05:00</td><td>Islamabad</td><td>+ 02:30</td><td></td></tr> <tr><td>+ 04:00</td><td>Abu Dhabi</td><td>+ 01:30</td><td></td></tr> <tr><td>+ 03:00</td><td>Moscow</td><td>+ 00:30</td><td></td></tr> <tr><td>+ 02:00</td><td>Eastern Europe</td><td>+ 12:45</td><td>Chatham Islands</td></tr> <tr><td>+ 01:00</td><td>Central Europe</td><td></td><td></td></tr> </tbody> </table>	Time difference (from GMT)	Region (city)	Time difference (from GMT)	Region (city)	00:00	Greenwich	- 00:30		- 01:00	Azores	- 01:30		- 02:00	Central Atlantic	- 02:30		- 03:00	Buenos Aires	- 03:30	Newfoundland	- 04:00	Halifax (Nova Scotia)	- 04:30		- 05:00	New York	- 05:30		- 06:00	Chicago	- 06:30		- 07:00	Denver	- 07:30		- 08:00	Los Angeles	- 08:30		- 09:00	Alaska	- 09:30	Marquesas Islands	- 10:00	Hawaii	- 10:30		- 11:00	Midway Islands	- 11:30		- 12:00	Kwajalein Atoll	+ 11:30	Norfolk Islands	+ 13:00		+ 10:30	Lord Howe Island	+ 12:00	New Zealand	+ 09:30	Darwin Islands	+ 11:00	Solomon Islands	+ 08:30		+ 10:00	Guam	+ 07:30		+ 09:00	Tokyo	+ 06:30	Rangoon	+ 08:00	Beijing	+ 05:30	Mumbai (Bombay)	+ 07:00	Bangkok	+ 04:30	Kabul	+ 06:00	Dhaka	+ 03:30	Teheran	+ 05:00	Islamabad	+ 02:30		+ 04:00	Abu Dhabi	+ 01:30		+ 03:00	Moscow	+ 00:30		+ 02:00	Eastern Europe	+ 12:45	Chatham Islands	+ 01:00	Central Europe		
Time difference (from GMT)	Region (city)	Time difference (from GMT)	Region (city)																																																																																																										
00:00	Greenwich	- 00:30																																																																																																											
- 01:00	Azores	- 01:30																																																																																																											
- 02:00	Central Atlantic	- 02:30																																																																																																											
- 03:00	Buenos Aires	- 03:30	Newfoundland																																																																																																										
- 04:00	Halifax (Nova Scotia)	- 04:30																																																																																																											
- 05:00	New York	- 05:30																																																																																																											
- 06:00	Chicago	- 06:30																																																																																																											
- 07:00	Denver	- 07:30																																																																																																											
- 08:00	Los Angeles	- 08:30																																																																																																											
- 09:00	Alaska	- 09:30	Marquesas Islands																																																																																																										
- 10:00	Hawaii	- 10:30																																																																																																											
- 11:00	Midway Islands	- 11:30																																																																																																											
- 12:00	Kwajalein Atoll	+ 11:30	Norfolk Islands																																																																																																										
+ 13:00		+ 10:30	Lord Howe Island																																																																																																										
+ 12:00	New Zealand	+ 09:30	Darwin Islands																																																																																																										
+ 11:00	Solomon Islands	+ 08:30																																																																																																											
+ 10:00	Guam	+ 07:30																																																																																																											
+ 09:00	Tokyo	+ 06:30	Rangoon																																																																																																										
+ 08:00	Beijing	+ 05:30	Mumbai (Bombay)																																																																																																										
+ 07:00	Bangkok	+ 04:30	Kabul																																																																																																										
+ 06:00	Dhaka	+ 03:30	Teheran																																																																																																										
+ 05:00	Islamabad	+ 02:30																																																																																																											
+ 04:00	Abu Dhabi	+ 01:30																																																																																																											
+ 03:00	Moscow	+ 00:30																																																																																																											
+ 02:00	Eastern Europe	+ 12:45	Chatham Islands																																																																																																										
+ 01:00	Central Europe																																																																																																												

\_\_\_\_ The underlined settings are the factory mode settings.

## OTHER FUNCTIONS screen (continued)

Item	Description of settings
<b>POWER SAVE</b>	<p>This is used to select the power-saving mode which is to be established when none of the buttons have been operated for 5 or so minutes.</p> <p><b>ON:</b> The unit's power is turned off.</p> <p><b>OFF:</b> The unit's power is not turned off, and it remains in the power ON mode.</p> <ul style="list-style-type: none"> <li>While the unit is connected by an IEEE1394 cable or USB cable to an external device and communicating with it, the power will not be turned off even if the function keys or buttons have not been operated for the prescribed period of time.</li> <li>Even when ON is selected as this item's setting, the power will not be turned off during playback (variable-speed playback and rapid forward/rapid reverse playback including pause).</li> </ul>
<b>SYSTEM FREQ</b>	<p>This is used to switch the system frequency.</p> <p><b><u>59.94 Hz</u>, 50 Hz (AG-HPG20P)</b> <b><u>59.94 Hz</u>, <u>50 Hz</u> (AG-HPG20E)</b></p> <p>&lt;Note&gt; When the system frequency has been changed, turn the unit's power off and then back on so that the setting takes effect.</p>
<b>USER FILE</b>	<p><b>LOAD:</b> The settings of the user files last saved are loaded.</p> <p><b>SAVE:</b> The settings of the user files which have been changed are stored.</p> <p><b>INITIAL:</b> The user file settings are returned to the factory settings. In order for the settings to take effect after loading or initializing, turn off the unit's power and turn it back on.</p> <ul style="list-style-type: none"> <li>Even when initializing has been performed, the setting on the setting menu "TIME ZONE" (Page 106) will remain unchanged.</li> </ul>

## DIAGNOSTIC screen

Item	Description of settings
<b>VERSION</b>	<p>This is used to display the version. More detailed version is displayed on the sub screen.</p>
<b>MODEL NAME</b>	This is used to display the model name.
<b>SERIAL NO.</b>	This is used to display the product number.
<b>OPERATION</b>	This is used to display the power-on time (using 5 digits).
<b>LCD OPERATION</b>	This is used to display the power-on time (using 5 digits) for the backlight of the LCD monitor.

\_\_\_ The underlined settings are the factory mode settings.

## List of setting menus (continued)

### OPTION MENU screen

If [MENU/MODE CHK] is pressed with  held down on the normal display screen, OPTION MENU is displayed on the setting menu.

Item	Description of settings
<b>1394 STATUS</b>	The 1394 status display sub-screen is displayed. <b>FORMAT:</b> Format of the input or output signals <b>RATE:</b> Transfer rate of the input or output signals <b>60/50:</b> System of input or output signals <b>CH:</b> Value of the channels whose signals are input or output <b>SPEED:</b> Transfer speed of the input or output signals <b>STATUS:</b> Status of the signals which are input or output by the IEEE1394 digital interface <b>VIDEO:</b> Status of the input or output video signals <b>AUDIO:</b> Status of the input or output audio signals
<b>1394 CONFIG</b>	This is the 1394 expansion menu. <b><u>DFLT:</u></b> For normal operation, keep this setting. <b>1-255</b>

\_\_\_\_ The underlined settings are the factory mode settings.



# Warning system table

When trouble is detected immediately after the power is turned on or during operation, the user is alerted by the power display LED and beep sound (provided that "ON" is selected for the "BEEP SOUND" setting on the setting menu "OTHER FUNCTIONS" (Page 106)).

Priority	Type of warning	LCD monitor screen display	Power display LED	Beep sound	Warning description and record/playback operation	Action to be taken
1	System error	SYSTEM ERROR Cause displayed*1, blinks in red.	Blinks at a rate of 4 times per second.	Beeps continuously.	P2 microprocessor or control trouble. Operation is stopped.	Check the cause display*1, and consult your vendor.
2	P2 card ejection trouble	TURN POWER OFF Blinks in red.	Blinks at a rate of 4 times per second.	Beeps continuously.	Trouble has occurred in the internal memory because a P2 card was ejected while its data was being accessed. Both access LEDs blink in orange (4 Hz).	Turn off the power. If something is wrong with the clips on the ejected P2 card, repair them.
3	Low battery charge	LOW BATTERY Blinks in red. Blinks with the remaining battery display empty. (This display appears even when it has been set to OFF on the setting menu.)	Blinks at a rate of once per second.	Beeps continuously.	The battery charge is low. Recording or playback stops. If the voltage falls further, the power is automatically turned off.	Replace the battery.
4	P2 card full	[P2] FULL Blinks in red (display appears only for 3 seconds when [REC] is pressed).	Blinks at a rate of 4 times per second upon completion of recording.	Beeps continuously upon completion of recording.	There is no more free memory left on the P2 card. Recording is stopped*3.	Delete the unnecessary clips or insert a new card.
5	Recording trouble	REC WARNING Cause displayed*2, blinks in red.	Blinks at a rate of 4 times per second.	Beeps intermittently at a rate of 4 times per second.	Recording trouble. Recording is stopped*4.	Turn off the power and turn it back on. Then check the recording/playback. Replace the P2 card if recording cannot be performed properly.
6	Near low battery charge	One block on the remaining battery display is blinking. (This display appears even when it has been set to OFF on the setting menu.)	Blinks at a rate of once per second.	None	The battery charge is falling to low. Operation is continued.	Replace the battery as necessary.
7	P2 card nearly full	Remaining media memory display blinks.	Blinks at a rate of once a second during recording.	None	Under 2 minutes of memory remaining on the P2 card (remaining memory display shows less than one minute). This warning appears only during recording.	Replace the P2 card or add another card as necessary.
8	Input image frame distorted during recording	IRREGULAR FRM SIG	Blinks at a rate of once a second during recording.	Beeps intermittently at a rate of 2 times per second.	Recording stops due to the input signal distortion. The recording will automatically resume when input signals are stabilized.	Check the input signals.

\*1 P2 SYSTEM ERROR Cause display

- P2 MICON ERROR: P2 microprocessor does not respond.
- P2 CONTROL ERROR: Trouble has occurred in the P2 recording control.
- REC RAM OVERFLOW: Recording RAM overflow

\*2 REC WARNING Cause display

- CARD ERROR\*: P2 card trouble (slot number of trouble card is displayed in \*)
- REC RAM OVERFLOW: Recording RAM overflow
- ERROR: Other recording trouble

\*3 The warning is cleared when any one of the following operations is performed.

- When a playback function button (STOP, PLAY, STILL, FF or REW) is pressed
- When the PC mode is selected while [THUMBNAIL/MODE] is held down for more than 2 seconds
- When a P2 card has been ejected or another card has been inserted

\*4 The warning is cleared when any one of the following operations is performed.

- When a playback function button (STOP, PLAY, STILL, FF or REW) is pressed
- When a P2 card has been ejected

# Troubleshooting (Q&A)

## Power-related Q&A

<b>No power.</b>	<ul style="list-style-type: none"><li>• Has the battery or AC adapter been connected properly? Check the connections.</li><li>• When turning on the power, hold down [POWER] for at least 1 second.</li></ul>	P 21 P 22
<b>The power suddenly goes off without warning.</b>	<ul style="list-style-type: none"><li>• In order to preserve the battery charge, the power will be automatically turned off when more than 5 minutes with no operations performed have elapsed. Check the setting menu: "OTHER FUNCTIONS"—"POWER SAVE".</li></ul>	P 107
<b>The power is turned on but it goes off immediately.</b>	<ul style="list-style-type: none"><li>• Has the battery charge been depleted? If the remaining battery charge display is blinking or <input type="text"/> is displayed, it means that there is little or no charge left in the battery. Charge the battery or replace the existing battery with a fully charged battery.</li></ul>	P 82

## Battery-related Q&A

<b>The battery charge is depleted quickly.</b>	<ul style="list-style-type: none"><li>• Was the battery charged sufficiently? Charge the battery until the CHARGE lamp on the AC adapter goes off.</li><li>• Is the battery being used in a location where the temperature is low? Batteries are affected by the ambient temperature. Batteries operate for shorter periods of time at low-temperature locations.</li><li>• Has the battery reached the end of its service life? The battery may have reached the end of its service life. Although the service life will differ depending on how the battery has been used, if the battery can be used only for short periods of time even after it has been fully charged, it means that it has reached the end of its service life.</li></ul>	P 20 — —
<b>The battery cannot be charged.</b>	<ul style="list-style-type: none"><li>• The battery cannot be charged if the DC cord is connected to the AC adapter.</li></ul>	P 21

## Recording

<p><b>Recording does not start.</b></p>	<ul style="list-style-type: none"> <li>• Is the unit's power on?</li> <li>• Has the battery reached the end of its service life? The battery may have reached the end of its service life. Although the service life will differ depending on how the battery has been used, if the battery can be used only for short periods of time even after it has been fully charged, it means that it has reached the end of its service life.</li> </ul>	<p>P 22 —</p>
<p><b>The P2 card has been inserted properly, but recording is not possible.</b></p>	<ul style="list-style-type: none"> <li>• Is the P2 card's write-protect switch at the PROTECT position? Images cannot be recorded while this switch is at the PROTECT position.</li> <li>• Does the P2 card have very little remaining memory? Either save the data concerned on another media and delete the unnecessary data on the P2 card concerned or replace the P2 card with a new card.</li> <li>• Has the P2 card been formatted properly? Does the card have a format which cannot be used? Format the card using the unit.</li> <li>• P2 cards with a memory size of 2 GB cannot be used.</li> </ul>	<p>P 29  P 55  P 29  P 31</p>
<p><b>The clip created during one recording has been divided.</b></p>	<ul style="list-style-type: none"> <li>• A clip may be recorded in the divided state when the input signal is distorted during recording.</li> </ul>	<p>—</p>

## Troubleshooting (Q&A) (continued)

---

### Playback

<b>Mosaic-like noise appears during rapid forward or rapid reverse playback.</b>	<ul style="list-style-type: none"><li>This phenomenon is characteristic of digital equipment. It is not a sign of trouble.</li></ul>	—
<b>No playback pictures appear even though the TV set is connected properly.</b>	<ul style="list-style-type: none"><li>Is the input selector on the TV set at the “video input” position? Carefully read the instructions accompanying the TV set, and select the connected video input connector.</li></ul>	—
<b>No playback sound is heard from the unit’s speaker.</b>	<ul style="list-style-type: none"><li>Has the unit’s volume level been turned down too low? Press the PAGE/AUDIO MON/VAR “+” button, and adjust the volume level.</li><li>No sound can be heard from the speaker when headphones are connected to the headphone jack.</li></ul>	P 82 —
<b>No hot swap playback.</b>	<ul style="list-style-type: none"><li>This unit does not support hot swap playback. To continue playback, stop playback, and then replace the P2 card with another card.</li></ul>	P 64

### SD card

<b>Data cannot be read on the SD card.</b>	<ul style="list-style-type: none"><li>Has the SD card been formatted properly? Format the card using the unit.</li></ul>	P 33
--	--	------

### Software information for this product

1. Customer advisory: This product includes software licensed under the GNU General Public License (GPL) and GNU Lesser General Public License (LGPL); customers have the right to download, modify, and redistribute source code for this software.  
Descriptions of the GPL and LGPL are stored on the installation CD included with this camera-recorder. See the folder named \LDOC. (The description is the original (written in English)) To download the relevant source code, visit <https://www.pavc.panasonic.co.jp/pro-av/>  
Please note that we cannot answer any questions you may have about the content, etc. of any source code you may obtain from the above Web site.
2. This product includes software licensed under the MIT License. A description of the MIT is stored on the installation CD included with this portable recorder. See the folder named \LDOC. (The description is the original (written in English))

# Updating the drivers installed in the unit

---

The driver can be updated using either of the following two methods.

## 1. Checking the current version of the driver and performing the update using the dedicated tool (P2\_Status\_Logger)

PASS (P2 Asset Support System) is only available to customers who have completed customer registration with Panasonic.

Log in to PASS and use the dedicated tool (P2\_Status\_Logger) to check the version information of the driver on the unit and download links to pages containing the necessary drivers.

For further information about downloading and using P2\_Status\_Logger, log in to PASS and refer to the relevant pages.

Besides access to PASS, completing customer registration has a number of other benefits. For further details, refer to the PASS (P2 Asset Support System) website ([http://panasonic.biz/sav/pass\\_e/](http://panasonic.biz/sav/pass_e/)).

## 2. Checking the current version of the driver using the unit and performing the update

From the MAINTENANCE menu page, check the current version of the driver on the unit using the setting menu “DIAGNOSTIC”–“VERSION”. Then, access the website listed below for the latest driver-related information and download the driver as required.

---

### ■ Notes

- The update is completed by loading the downloaded file onto the unit via an SD card. For further details about the updating methods, refer to the following website.  
<https://www.pavc.panasonic.co.jp/pro-av/>
- Be sure to use a compatible SD card. The unit is compatible with SD cards based on the SD and SDHC standards. Also, be sure to format the memory card using the unit before use.

---

## Maintenance

---

### Do not use benzine or paint thinners to clean the unit.

- Doing so may deform the unit or cause its paint to peel off.
- Before cleaning the unit, remove the battery or unplug the AC cord from the power outlet.
- Wipe the unit with a clean soft cloth. To remove stubborn dirt, dip a cloth into some kitchen detergent which has been diluted with water, wring it out and wipe off the dirt, and then use a dry cloth to take up any remaining moisture.

---

## Condensation

---

When condensation forms on or inside the unit, the principle behind its formation is the same as when droplets of water form on the window panes of a heated room. It forms when the unit and its cards are brought into a space with significantly different temperature and humidity levels, specifically when:

- They have been brought to a very humid location full of steam or to a room immediately after the heating has been turned on.
- They have suddenly been brought from an air-conditioned place to a location with high temperature and humidity levels.

If the unit and its cards are brought to such locations, do not turn on the unit's power but leave the unit and cards standing for about 10 minutes.

# Storage precautions

---

Before storing the unit, remove its battery.  
Select a location with minimal moisture and a relatively constant temperature to store the unit.  
[Recommended ambient temperature: 15 °C to 25 °C (59 °F to 77 °F)]  
[Recommended relative humidity: 40 % to 60 %]

## Unit

- Wrap the unit in a soft cloth to protect it from dust and dirt.
- Avoid places exposed to the direct sunlight to keep this unit as the exterior parts and LCD screen may be damaged.

## Battery

- The service life of the battery will be shortened if the battery is kept where the temperature is extremely high or extremely low.
- Storing the unit in a location with high concentrations of oily smoke or dust may cause the connectors to become corroded and other trouble to occur.
- **Ensure that the battery terminals are not brought into contact with any metal objects (such as necklaces or hairpins). Otherwise, the terminals may be shorted and generate heat which could cause burns if touched.**
- When the battery is to be stored for a prolonged period, it is recommended that you charge it once a year, use the battery in the unit until its charge is used up, and then return it to storage.

## P2 card, SD card

- After removing the P2 cards from the unit, always remember to cover their terminals with the dedicated caps to keep sand and dust away from the connector areas. Keep the P2 cards in their protective cases when storing them or carrying them around.
- After removing the SD cards from the unit, always remember to put them in their protective cases.
- Do not store the cards wherever there are corrosive gases in the atmosphere.
- Do not leave the cards inside vehicles or in places exposed to direct sunlight or where the temperature will be high.
- Do not leave the cards in places where the humidity level is high or where there is a great deal of dust.

# Handling the data recorded on P2 cards

“P2 cards” are semiconductor memory cards which have been adopted as the recording media for the “DVCPRO P2 series” of professional-use video production and broadcast equipment.

- The data recorded on the P2 card (P2 data) is in a file format which is highly compatible with personal computers. The data file structure has its own format, the files contain not only the video and audio data which are converted into MXF files but various other important information, and the data is associated in the folder configuration shown on the right.

**Changing or deleting some of this information may result in trouble: for instance, it may make it impossible for the data to be recognized as P2 data or for the cards to be used in P2 devices.**

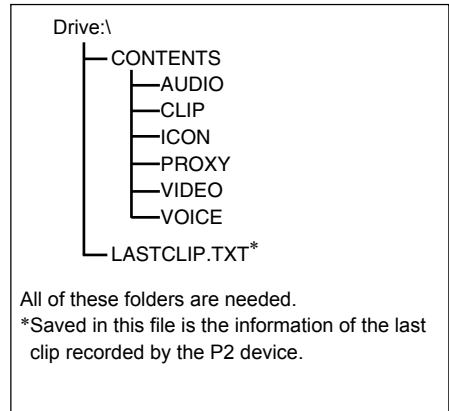

- In order to prevent any of the information from being lost when transferring the data on a P2 card to a personal computer or writing the data stored in a personal computer onto a P2 card, be absolutely sure to download the dedicated software, “P2 viewer” or “P2 content management software” from the following web site and use it for this purpose.  
(For supporting OS, refer to the following web site as well.)

<https://www.pavc.panasonic.co.jp/pro-av/>

- When transferring data to a personal computer using a regular IT tool such as Microsoft Windows Explorer or Apple Finder, proceed as follows.  
To return the data to the P2 card, be absolutely sure to use the “P2 viewer” or “P2 content management software”.
- Transfer the data together with the CONTENTS folder and LASTCLIP.TXT file.  
Do not perform any operations for the files under the CONTENTS folder.  
When copying data, copy the LASTCLIP.TXT file together with the CONTENTS folder.
- When transferring the data on a multiple number of P2 cards to a personal computer, create the folder for each P2 card in order to prevent the same clip names from being overwritten.
- Do not delete the data on P2 cards.
- P2 cards must always be formatted using a P2 device prior to use.

- 
- “Microsoft” and “Windows” are the registered trademarks of Microsoft Corporation of the United States in the United States and other countries.
  - “Apple” and “Macintosh” are the registered trademarks of Apple Inc., of the United States in the United States and other countries.

# Use of SD/SDHC memory cards

---

In this unit, use SD cards which comply with the SD standard or SDHC standard.

If miniSD or miniSDHC cards are going to be used in this unit, be absolutely sure to install the special adapter prior to using them. (The unit will not operate properly if only the adapter is installed on the unit)

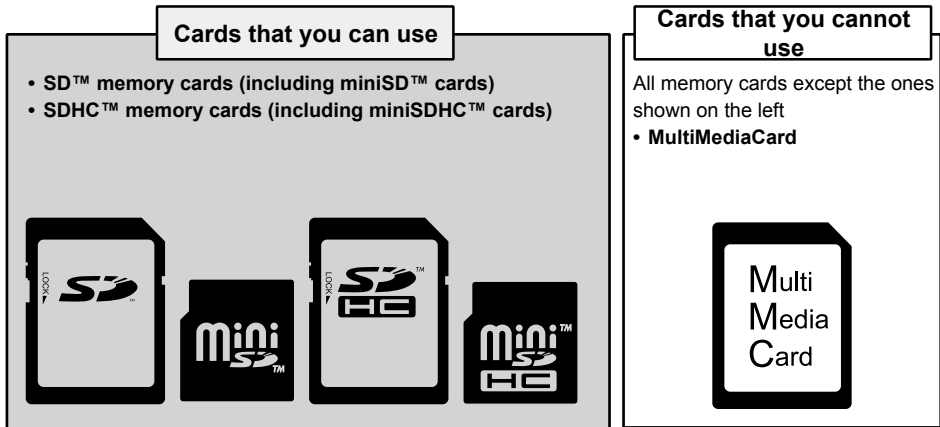

SD cards with the following memory sizes can be used within this unit.

**SD (8 MB to 2 GB):**

8 MB	16 MB	32 MB	64 MB	128 MB
256 MB	512 MB	1 GB	2 GB	

**SDHC (4 GB to 32 GB):**

4 GB	8 GB	16 GB	32 GB
------	------	-------	-------

It is recommended that the SD and SDHC memory cards or the miniSD and miniSDHC cards made by Panasonic be used.

For the latest information on the unit and the memory cards which can be used by the unit, access the P2 support page on the web site below.

<https://www.pavc.panasonic.co.jp/pro-av/>

- 
- SDHC is a new standard for memory cards with memory sizes of 2 GB or more which was formulated in 2006 by the SD Association.
  - The SD card logo is a registered trademark.
  - MMC (MultiMediaCard) is a registered trademark of Infineon Technologies AG.



# Specifications

## [GENERAL]

<b>Supply voltage</b>	DC7.2 V/7.9 V
<b>Power consumption</b>	12 W

indicates safety information.

### Operating ambient temperature

0 °C to 40 °C (32 °F to 104 °F)

### Operating ambient humidity

10 % to 80 % (no condensation)

### Storage ambient temperature

-20 °C to 50 °C (-4 °F to 122 °F)

### Weight

1.1 kg (2.42 lb) (main unit)

### Dimensions (W x H x D)

104.0 mm x 83.0 mm x 227.0 mm  
(4-3/32 inches x 3-9/32 inches x 8-15/16 inches)  
(Excluding the foot parts and protrusions such as the cap)

### Recording media

P2 card

## [VIDEO]

### Video recording formats

1080/59.94i, 1080/50i, 720/59.94p, 720/50p  
(AVC-Intra100/AVC-Intra50/DVCPRO HD format switching)

480/59.94i, 576/50i (DVCPRO50/DVCPRO/DV format switching)

- AVC-Intra100/AVC-Intra50 are not supported for 1394 input.

### Playback formats

AVC-Intra100/AVC-Intra50

1080/59.94i  
1080/50i  
1080/29.97pN (native recording)  
1080/23.98pN (native recording)  
1080/25pN (native recording)  
720/59.94p  
720/29.97pN (native recording)  
720/23.98pN (native recording)  
720/50p  
720/25pN (native recording)

DVCPRO HD

1080/59.94i (29.97p over 59.94i, 23.98p over 59.94i, 23.98pA over 59.94i)  
1080/50i (25p over 50i)  
720/59.94p (29.97p over 59.94p, 23.98p over 59.94p)  
720/29.97pN (native recording)  
720/23.98pN (native recording)  
720/50p (25p over 50p)  
720/25pN (native recording)

DVCPRO50/DVCPRO/DV

480/59.94i (29.97p over 59.94i, 23.98p over 59.94i, 23.98pA over 59.94i)  
576/50i (25p over 50i)

### Sampling frequency

AVC-Intra100/DVCPRO HD:

Y: 74.176MHz (59.94Hz)

74.25MHz (50Hz)

PB/PR: 37.088MHz (59.94Hz)

37.125MHz (50Hz)

DVCPRO50:

Y: 13.5MHz

PB/PR: 6.75MHz

DVCPRO:

Y: 13.5MHz

PB/PR: 3.375MHz

### Quantizing

AVC-Intra100/AVC-Intra50: 10bits

DVCPRO HD/DVCPRO50/DVCPRO/DV: 8bits

### Video compression system

AVC-Intra100/AVC-Intra50:

MPEG-4 AVC/H.264 Intra-Profile

DVCPRO HD:

DV base (SMPTE 370M)

DVCPRO50/DVCPRO:

DV base (SMPTE 314M)

DV:

DV (IEC 61834-2)

### Video input

HD/SD-SDI input: BNC x 1 selectable

HD: Compliance with SMPTE 292M/296M/299M standards (The return loss does not satisfy the specifications.)

SD: Compliance with SMPTE 259M-C/272M-A/ITU-R BT.656-4 standards

### Video outputs

HD/SD-SDI output: BNC x 1 selectable

HD: Compliance with SMPTE 292M/296M/299M standards (The return loss does not satisfy the specifications.)

SD: Compliance with SMPTE 259M-C/272M-A/ITU-R BT.656-4 standards

Analog composite output:

BNC x 1, Video: 1.0 Vp-p, 75 Ω

## Specifications (continued)

### [MEMORY CARDS]

#### Recording/playback time

Capacity of the P2 card	No. of cards used	Formatting		
		DVCPRO/DV Audio 2CH/4CH	DVCPRO50 Audio 4CH AVC-Intra50 Audio 8CH	DVCPRO HD AVC-Intra 100 Audio 8CH
4 GB	1 card	Approx. 16 minutes	Approx. 8 minutes	Approx. 4 minutes
	2 cards	Approx. 32 minutes	Approx. 16 minutes	Approx. 8 minutes
8 GB	1 card	Approx. 32 minutes	Approx. 16 minutes	Approx. 8 minutes
	2 cards	Approx. 64 minutes	Approx. 32 minutes	Approx. 16 minutes
16 GB	1 card	Approx. 64 minutes	Approx. 32 minutes	Approx. 16 minutes
	2 cards	Approx. 128 minutes	Approx. 64 minutes	Approx. 32 minutes
32 GB	1 card	Approx. 128 minutes	Approx. 64 minutes	Approx. 32 minutes
	2 cards	Approx. 256 minutes	Approx. 128 minutes	Approx. 64 minutes
64 GB	1 card	Approx. 256 minutes	Approx. 128 minutes	Approx. 64 minutes
	2 cards	Approx. 512 minutes	Approx. 256 minutes	Approx. 128 minutes

### [AUDIO]

#### Audio recording formats

48kHz 16bits 8CH

(AVC-Intra100, AVC-Intra50, DVCPRO HD\*)

\* 48kHz 16bits 4CH for 1394 input

48kHz 16bits 4CH  
(DVCPRO50)

48kHz 16bits 2CH or 4CH  
(DVCPRO, DV)

- 32 kHz, 12 bits, 4 channel input signals in the DV format are converted into 48 kHz, 16 bits and 4 channels, and recorded.

#### Audio input

SDI input BNC × 1

(HD: Compliance with SMPTE 292M/296M/299M, SD: Compliance with SMPTE 259M-C/272M-A/ITU-R BT.656-4)

#### Audio outputs

SDI output BNC × 1

(HD: Compliance with SMPTE 292M/296M/299M, SD: Compliance with SMPTE 259M-C/272M-A/ITU-R BT.656-4)

LINE output

Pin jacks × 2 (CH1, CH2)

Headphones

Stereo mini-jack (3.5 mm diameter) × 1

Internal speaker

20 mm round type × 1 (monaural)

#### Headroom

12/18/20dB (selectable)

### [OTHER INPUTS/OUTPUTS]

#### IEEE1394 digital input/output

IEEE1394a 6-pin × 1

#### USB 2.0

HOST × 1 (type A, bus power)

DEVICE × 1 (type B)

### [P2 CARD SLOTS]

P2 card slots × 2

### [SD CARD SLOT]

SD/SDHC memory card slot × 1

(MultiMediaCards cannot be used.)

### [LCD MONITOR]

3.5-inch LCD color monitor (210,000 pixels)

### [AC ADAPTER]

#### Rated input

100 V to 240 V AC, 50/60 Hz, 24 W

#### Rated output

7.9 V DC, 1.9 A (Video Camera)

8.4 V DC, 1.2 A (during charging)

 indicates safety information.

#### Weight

160 g (0.35 lb)

#### Dimensions (W × H × D)

70.0 mm × 44.5 mm × 116.0 mm

(2-3/4 inches × 1-3/4 inches × 4-9/16 inches)

### [ACCESSORIES]

#### Battery

CGA-D54/CGA-D54s (5400 mAh: identical to supplied battery)

Inrush current, measured according to European standard EN55103-1: 6.4A

Weight and dimensions are approximate.

Specifications are subject to change without notice.

## For Europe

### Information for Users on Collection and Disposal of Old Equipment and used Batteries



These symbols on the products, packaging, and/or accompanying documents mean that used electrical and electronic products and batteries should not be mixed with general household waste.

For proper treatment, recovery and recycling of old products and used batteries, please take them to applicable collection points, in accordance with your national legislation and the Directives 2002/96/EC and 2006/66/EC.

By disposing of these products and batteries correctly, you will help to save valuable resources and prevent any potential negative effects on human health and the environment which could otherwise arise from inappropriate waste handling.

For more information about collection and recycling of old products and batteries, please contact your local municipality, your waste disposal service or the point of sale where you purchased the items.

Penalties may be applicable for incorrect disposal of this waste, in accordance with national legislation.



#### For business users in the European Union

If you wish to discard electrical and electronic equipment, please contact your dealer or supplier for further information.

#### Information on Disposal in other Countries outside the European Union

These symbols are only valid in the European Union. If you wish to discard these items, please contact your local authorities or dealer and ask for the correct method of disposal.



Cd

#### Note for the battery symbol (bottom two symbol examples):

This symbol might be used in combination with a chemical symbol. In this case it complies with the requirement set by the Directive for the chemical involved.

---

## **Panasonic Broadcast & Television Systems Company Unit Company of Panasonic Corporation of North America**

Executive Office: One Panasonic Way 4E-7, Secaucus, NJ 07094 Tel: 201-348-7000

Eastern Zone: One Panasonic Way 4E-7, Secaucus, NJ 07094 Tel: 201-348-7196

Southeast Region: Tel: 201-392-6151

Western Zone: 3330 Cahuenga Blvd W., Los Angeles, CA 90068 Tel: 323-436-3608

Government Marketing Department:

One Panasonic Way 2E-10, Secaucus, NJ 07094 Tel: 201-348-7587

**Broadcast PARTS INFORMATION & ORDERING:**

9:00 a.m. – 5:00 p.m. (EST) Tel: 800-334-4881/24 Hr, Fax: 800-334-4880

Emergency after hour parts orders Tel: 800-334-4881

e-mail: PBTSparts@us.panasonic.com

**TECHNICAL SUPPORT:** Emergency 24 Hour Service Tel: 800-222-0741

e-mail: PBTSCservice@us.panasonic.com

### **Panasonic Canada Inc.**

5770 Ambler Drive, Mississauga, Ontario L4W 2T3 Tel: 905-624-5010

### **Panasonic de México S.A. De C.V.**

Casa Matriz: Moras No.313 Col. Tlacoquemecatl Del Valle Del.Benito Juárez México, D.F., C.P.03200

Tel: 55-5488-1000 Fax: 55-5575-6783

### **Panasonic Latin America, S.A.**

P.O.Box 0816-03164 Panama, Republic of Panama Tel: +507-229-2955 Fax: 507-229-5352

### **Panasonic do Brasil Ltda.**

Rua Cubatão, 320-6º andar-Paraiso CEP 04013-001- São Paulo -SP Tel: 11-3889-4000 Fax: 11-3889-4004

### **Professional & Broadcast IT Systems Business Unit Europe**

### **Panasonic AVC Systems Europe a Division of Panasonic Marketing Europe GmbH**

Hagenauer Str. 43, 65203 Wiesbaden-Biebrich Deutschland Tel: +49-611-235-481

### **Panasonic Systems Asia Pacific (Broadcast Regional Operation Center)**

2 Jalan Kilang Barat, Panasonic Building, Singapore 159346 Tel: +65-6270-0110