

SONY®

4-196-546-12(1)

IC Recorder

Operating Instructions

Getting Started

Basic Operations

Other Recording Operations

Other Playback Operations

Editing Files

About the Menu Function

Utilizing Your Computer

Additional Information

Troubleshooting

Index

IC RECORDER

ICD-UX512

Owner's Record

The model number is located at the rear panel and the serial number is located inside the battery compartment. Record these numbers in the space provided below. Refer to these numbers whenever you call upon your Sony dealer regarding this product.

Model No. _____
Serial No. _____

The following FCC statement applies only to the version of this model manufactured for sale in the USA. Other versions may not comply with FCC technical regulations.

INFORMATION

This equipment has been tested and found to comply with the limits for a Class B digital device, pursuant to Part 15 of the FCC Rules. These limits are designed to provide reasonable protection against harmful interference in a residential installation. This equipment generates, uses and can radiate radio frequency energy and, if not installed and used in accordance with the instructions, may cause harmful interference to radio communications. However, there is no guarantee that interference will not occur in a particular installation. If this equipment does cause harmful interference to radio or television reception, which can be determined by turning the equipment off and on, the user is encouraged to try to correct the interference by one or more of the following measures:

Reorient or relocate the receiving antenna.
Increase the separation between the equipment and receiver.
Connect the equipment into an outlet on a circuit different from that to which the receiver is connected.
Consult the dealer or an experienced radio/TV technician for help.

You are cautioned that any changes or modifications not expressly approved in this manual could void your authority to operate this equipment.

If you have any questions about this product, you may call: Sony Customer Information Service Center 1-800-222-7669 or <http://www.sony.com/>

Declaration of Conformity

Trade Name : SONY
Model : ICD-UX512
Responsible Party : Sony Electronics Inc.
Address : 16530 Via Esprillo,
San Diego, CA 92127 USA
Telephone Number : 858-942-2230

This device complies with part 15 of the FCC Rules. Operation is subject to the following two conditions: (1) This device may not cause harmful interference, and (2) this device must accept any interference received, including interference that may cause undesired operation.

RECYCLING NICKEL METAL HYDRIDE BATTERIES

Nickel metal hydride batteries are recyclable.

You can help preserve our environment by returning your used rechargeable batteries to the collection and recycling location nearest you.

For more information regarding recycling of rechargeable batteries, call toll free 1-800-822-8837, or visit <http://www.rbrc.org/>.

Caution: Do not handle damaged or leaking nickel metal hydride batteries.



- The recorded music is limited to private use only. Use of the music beyond this limit requires permission of the copyright holders.
- Sony is not responsible for incomplete recording/downloading or damaged data due to problems of the IC recorder or computer.
- Depending on the types of the text and characters, the text shown on the IC recorder may not be displayed properly on device. This is due to:
 - The capacity of the connected IC recorder.
 - The IC recorder is not functioning normally.
 - Content information is written in the language or the character that is not supported by the IC recorder.

Notice for users

All rights reserved. This manual or the software described herein, in whole or in part, may not be reproduced, translated or reduced to any machine readable form without prior written approval from Sony Corporation.

IN NO EVENT SHALL SONY CORPORATION BE LIABLE FOR ANY INCIDENTAL, CONSEQUENTIAL OR SPECIAL DAMAGES, WHETHER BASED ON TORT, CONTRACT, OR OTHERWISE, ARISING OUT OF OR IN CONNECTION WITH THIS MANUAL, THE SOFTWARE OR OTHER INFORMATION CONTAINED HEREIN OR THE USE THEREOF.

Sony Corporation reserves the right to make any modification to this manual or the information contained herein at any time without notice. The software described herein may also be governed by the terms of a separate user license agreement.

- This software is for Windows and cannot be used for Macintosh.

- The supplied connection support cable is for the IC recorder ICD-UX512. You cannot connect other IC recorders.

What you record is for personal enjoyment and use only. Copyright laws prohibit other forms of use without the permission of the copyright holders. The use of Memory Stick™ media for recording copyright-protected graphics or other data is limited to the restrictions specified under applicable copyright laws. Any use beyond those restriction is prohibited.

This product supports “Memory Stick Micro™ (M2™)” media. “M2™” is an abbreviated form of “Memory Stick Micro™.” Hereinafter, “M2™” is used in this document.

Trademarks

- Microsoft, Windows, Windows Vista and Windows Media are registered trademarks or trademarks of Microsoft Corporation in the United States and/or other countries.
- Macintosh and Mac OS are trademarks of Apple Inc., registered in the USA and other countries.
- Pentium is a registered trademark of Intel Corporation.
- MPEG Layer-3 audio coding technology and patents licensed from Fraunhofer IIS and Thomson.
- microSD and microSDHC logos are trademarks of SD-3C, LLC.



- “Memory Stick Micro,” “M2” and  are trademarks or registered trademarks of Sony Corporation.
- “MagicGate” is a trademark of Sony Corporation.
- Nuance, the Nuance logo, Dragon, Dragon NaturallySpeaking, and RealSpeak are trademarks and/or registered trademarks of Nuance Communications Inc., and/or its affiliates in the United States and/or other countries.
- US and foreign patents licensed from Dolby Laboratories.

All other trademarks and registered trademarks are trademarks or registered trademarks of their respective holders. Furthermore, “™” and “®” are not mentioned in each case in this manual.

The “Sound Organizer” uses software modules as shown below:

Windows Media Format Runtime

This product contains technology subject to certain intellectual property rights of Microsoft. Use or distribution of this technology outside of this product is prohibited without the appropriate license(s) from Microsoft.

Table of Contents

Getting Started

Step 1: Checking the Contents of the Package	8
Index to parts and controls	9
Preventing unintentional operations (HOLD)	10
Step 2: Recharging the Battery	11
Recharging the battery using a computer	11
Recharging the battery using a USB AC adaptor	13
When to charge/replace the battery	13
Step 3: Turning the IC Recorder On	14
Turning the power on	14
Turning the power off	14
Step 4: Setting the Clock	15
Setting the clock after recharging the battery	15
Setting the clock using the menu	15
Step 5: Setting the Language to Be Used in the Display Window	18

Basic Operations

Recording	19
Listening	23
Erasing	28

Other Recording Operations

Changing the Recording Settings	30
Selecting a recording scene for each situation	30
Starting to record automatically in response to sound	
– the VOR function	35
Recording on a Memory Card	36
Recording via Other Devices	40
Recording with an external microphone	40
Recording from other equipment	41
Operation during Recording	44
Monitoring the recording	44

Other Playback Operations

Changing the Playback Settings	45
Convenient playback methods	45
Reducing noise in the playback sound and making the human voice clearer – the noise cut function	46
Adjusting the playback speed	
– the DPC (Digital Pitch Control) function	47
Selecting the sound effect	48
Selecting the playback mode	50
Playing Back a File at a Desired Time with an Alarm	52

Playback via Other Devices	54
Recording with other equipment	54

Editing Files

Arranging Files in a Folder	55
Moving a file to a different folder	55
Copying a file to the other memory	56
Erasing all files in a folder	57
Using a Track Mark	59
Adding a track mark	59
Erasing a track mark	60
Erasing all the track marks in the selected file at one time	61
Dividing a File	62
Dividing a file at the current position	62
Dividing a file at all the track mark positions	63
Protecting a File	65

About the Menu Function

Making Settings for the Menu	66
Menu Settings	67

Utilizing Your Computer

Using the IC Recorder with Your Computer	80
Connecting the IC recorder to your computer	80
Structure of folders and files	81
Disconnecting the IC recorder from your computer	85
Copying Files from the IC Recorder to Your Computer	86
Copying Music Files from Your Computer to the IC Recorder and Playing Them Back	87
Copying a music file from your computer to the IC recorder (drag and drop)	87
Playing back music files copied from your computer using the IC recorder	87
Using the IC Recorder as USB Memory	89
Using the Supplied Sound Organizer Software	90
What you can do using Sound Organizer	90
System requirements for your computer	91
Installing Sound Organizer	92
The Sound Organizer window	94

Additional Information

Using a USB AC Adaptor	95
Disconnecting the IC recorder from the AC outlet	96
Precautions	97
Specifications	100
System requirements	100
Design and specifications	101
Battery life	104

Troubleshooting

Troubleshooting	105
Message List	114
System Limitations	118
Display Window Guide	119
Index	124

Step 1: Checking the Contents of the Package

IC Recorder (1)

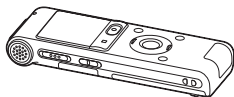

Remove the film on the display window before you use the IC recorder.

Stereo headphones (1)



USB connection support cable (1)

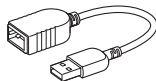

If the IC recorder cannot be connected to a computer directly, use the supplied USB connection support cable.

NH-AAA (size AAA) rechargeable battery (1)

Battery case (1)

Application software, Sound Organizer (CD-ROM) (1)

Operating Instructions

You are cautioned that any changes or modifications not expressly approved in this manual could void your authority to operate this equipment.

Index to parts and controls

Front

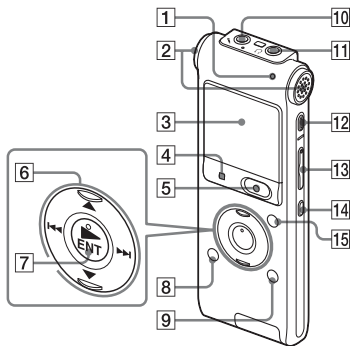

- 1 Operation indicator
- 2 Built-in microphones (stereo)
- 3 Display window
- 4 ■ STOP button
- 5 ● REC (record)/PAUSE button
- 6 Control button (▲, ▼ / ◀▶ (review/fast backward), ▶▶ (cue/fast forward))
- 7 ► (play)/ENT (enter) button*
- 8 📁 (folder) button
- 9 MENU/NOISE CUT button
- 10 🎧 (microphone) jack*
- 11 🎧 (headphone) jack

- 12 ERASE button
- 13 VOL (volume) -/+* button
- 14 ↺ (repeat) A-B button
- 15 T-MARK (Track mark) button

Rear

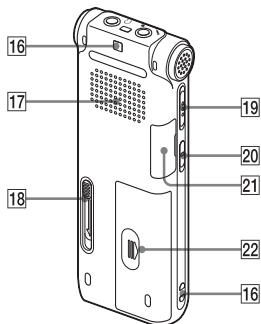

- 16 Strap hole (A strap is not supplied.)
- 17 Speaker
- 18 USB slide lever
- 19 HOLD/POWER switch
- 20 DPC(SPEED CTRL) switch
- 21 M2™/microSD memory card slot
- 22 Battery compartment

* These buttons and the jack have a tactile dot.
Use it as a reference point for operations, or to identify each terminal.

Preventing unintentional operations (HOLD)

You can disable all the buttons (HOLD) in order to prevent unintentional operations when you carry the IC recorder, etc.

To put the IC recorder in the HOLD status

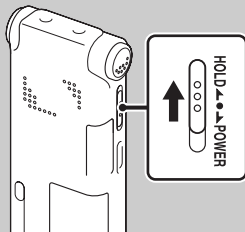

Slide the HOLD/POWER switch in the direction of “HOLD.”

“HOLD” will appear for approximately 3 seconds, indicating that all the button operations are disabled.



To release the IC recorder from the HOLD status

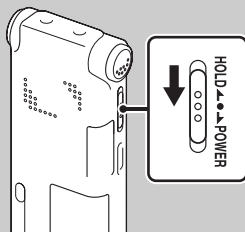

Slide the HOLD/POWER switch towards the center.

Note

When the HOLD function is activated during recording, all the button operations are disabled. To stop recording, cancel the HOLD function first.

Tip

Even if the HOLD function is activated, you can stop the alarm playback by pressing any button. (You cannot stop normal playback.)

Step 2: Recharging the Battery

Recharging the battery using a computer

Remove the film on the display window before you use the IC recorder. Connect the IC recorder to a running computer, and charge the battery until the battery indicator indicates “Full.” It takes about 3 hours and 30 minutes to fully charge an exhausted battery.*1

- 1 Insert a rechargeable battery. Slide and lift the battery compartment lid, insert an NH-AAA rechargeable battery with correct polarity, and close the lid.

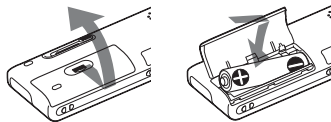

- 2 Connect the IC recorder to your computer. Slide the USB slide lever on the back of the IC recorder in the direction of the

arrow, and insert the USB DIRECT connector into the USB port of a running computer.*2

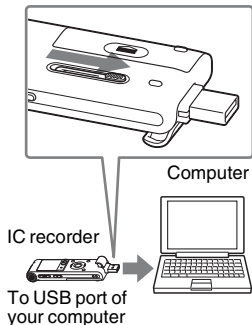

While the battery is charging, “Connecting” and the battery indicator are displayed in an animation.

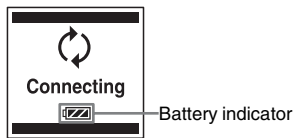

When the battery is fully charged, the battery indicator will indicate “ **FULL** .”



3 Disconnect the IC recorder from your computer.

Follow the procedures below; otherwise, when the IC recorder contains data files, the files may be damaged or become unplayable.

- 1 Make sure that the operation indicator does not light.
- 2 Perform the following operation on your computer.
On a Windows screen, left-click the icon at the bottom of the desktop of the computer.



→ Left-click “Eject IC RECORDER.”

The icon and menu displayed can be different on different operating systems.

On a Macintosh screen, drag “IC RECORDER” on the desktop to “Trash” and drop it there.

For details on disconnecting the IC recorder from your computer, refer to the operating instructions supplied with your computer.

- 3 Disconnect the IC recorder from the USB port of the computer, and slide the USB slide lever in the direction of the arrow to retract the USB DIRECT connector.

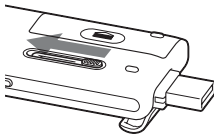

- *1 This is an approximation for the time it takes to charge from no remaining battery power to full battery power at room temperature. It varies depending on the remaining power and the condition of the battery. It also takes more time if the temperature of the battery is low, or if the battery is charged while you are transferring data to the IC recorder.
- *2 If the IC recorder cannot be connected to a computer directly, use the supplied USB connection support cable.

Note

If the battery indicator is not displayed in an animation, charging has not been done properly. See “Troubleshooting” on page 105.

When using a fully charged battery or an LR03 (size AAA) alkaline battery

Follow the step 1.

Note

You cannot charge an LR03 (size AAA) alkaline battery (not supplied).

Tips

- Do not use a manganese battery for this IC recorder.
- When replacing the battery, files recorded or alarm settings are not erased even when you remove the battery.
- When replacing the battery, the clock continues moving for about 1 minute after you remove the battery.

Recharging the battery using a USB AC adaptor

You can also charge the battery by using an AC-U501AD USB AC adaptor, etc. (not supplied) (page 95).

When to charge/replace the battery

The battery indicator on the display shows the battery condition in an animation.

Battery remain indication

 : “Low Battery Level” appears.

Charge the rechargeable battery or replace the old battery with a new one.



 : “Low Battery” appears and the IC recorder will stop operation.

Step 3: Turning the IC Recorder On

Turning the power on

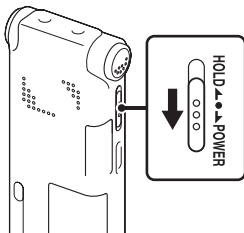

Slide the HOLD/POWER switch in the direction of “POWER” for more than 1 second. The IC recorder is turned on, and the “Accessing...” animation is displayed.

Turning the power off

Slide the HOLD/POWER switch in the direction of the “POWER” for more than 2 seconds, and “Power Off” animation is displayed.

💡 Tips

- When you are not going to use the IC recorder for a long time, we recommend to turn off the IC recorder.
- When the IC recorder is in the stop mode, and you leave the IC recorder without attempting an operation for a certain length of time, the auto power off function will take effect. (The length of time before auto power off is set to “10min” when you purchase the IC recorder.) You can select the length of time before auto power off takes effect in the menu (page 78).

Step 4: Setting the Clock

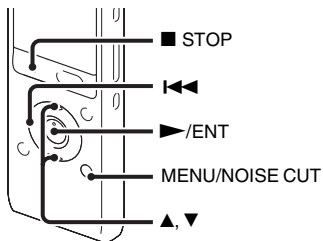

You need to set the clock to use the alarm function or record the date and time. When you insert a battery for the first time, or when you insert a battery after the IC recorder has been without a battery for more than 1 minute, the “Set Date&Time” animation appears, and then the year section begins to flash in the clock setting display window.

Setting the clock after recharging the battery

- 1 Press ▲ or ▼ on the control button to set the year, month, day, hour, and minute in sequence, and then press ▶/ENT.

Select the last two digits of the year when you set the year.

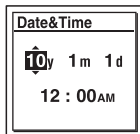

- 2 Press ■ STOP to return to the stop mode display.

Setting the clock using the menu

While the IC recorder is in the stop mode, you can set the clock using the menu.

- 1 Select “Date&Time” in the menu.
 - ① Press MENU/NOISE CUT to enter the menu mode.

The menu mode window will be displayed.



- Press **◀◀** on the control button, press **▲** or **▼** on the control button to select the  (IC recorder setting) tab, and then press **▶/ENT**.
- Press **▲** or **▼** on the control button to select "Date&Time," and then press **▶/ENT**.

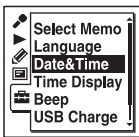

- Press **▲** or **▼** on the control button to select "Auto" or "Manual," and then press **▶/ENT**.



When you selected "Auto," the clock is automatically adjusted using the clock in the computer connected to the IC recorder and on which the supplied Sound Organizer software is started. When you select "Manual," proceed to the next steps.

- Press **▲** or **▼** on the control button to select "10y1m1d," and then press **▶/ENT**.

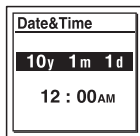

- Press **▲** or **▼** on the control button to set the year, month, day, hour, and minute in sequence, and then press **▶/ENT**. Select the last two digits of the year when you set the year.

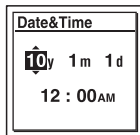

- Press **■ STOP** to exit the menu mode.

Note

If you do not press **▶**/ENT within 1 minute of entering the clock setting data, the clock setting mode is canceled and the window will return to the display of the stop mode.

To display the current date and time

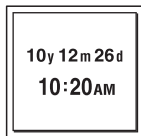

While the IC recorder is in the stop mode, press **■** STOP to display the current date and time for about 3 seconds.



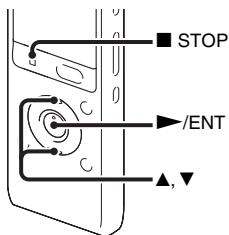



Step 5: Setting the Language to Be Used in the Display Window

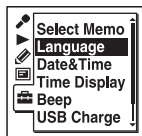

You can select the language to be used for messages, menus, folder names, file names, etc. from 3 languages.

- 1 Select the  (IC recorder setting) tab → “Language” in the menu, and then press /ENT.



- 2 Press  or  on the control button to select the language that you want to use, and then press /ENT.



You can select the following languages.
English, Español (Spanish), Français (French)

- 3 Press  STOP to exit the menu mode.

Recording

■ Notes

- Before making a recording, be sure to check the battery indicator (page 13).
- Noise may be recorded if an object, such as your finger, etc., accidentally rubs or scratches the IC recorder during recording.

💡 Tip

Before you start recording, we recommend you make a trial recording first, or monitor the recording (page 44).

Selecting a folder

- 1 Slide the HOLD/POWER switch towards the center to release the IC recorder from the HOLD status (page 10).

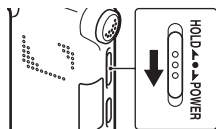

- 2 Press  to display the folder selection window.

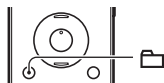

- 3 Press ◀◀ on the control button, press ▲ or ▼ on the control button to select the 🗣️ (Voice) tab, and then press ▶▶ on the control button.

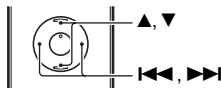

Note

Only the 🗣️ (Voice) tab will be displayed when you purchase the IC recorder.

The 🎵 (Music) tab and the 🎧 (Podcast) tab will be displayed when you transfer files from your computer (page 87, 91). The 💾 (Built-in memory) tab will be displayed when you insert a memory card into the IC recorder (page 37).

- 4 Press ▲ or ▼ on the control button to select the folder in which you want to record files.

When you purchase the IC recorder, there are 5 folders already available (📁 FOLDER01-05).

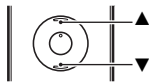

5 Press ►/ENT.

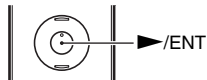

Starting to record (Auto (AGC) recording)

1 Place the IC recorder so that the built-in microphones face the direction of the source to be recorded.

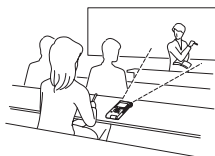

2 Press ● REC/PAUSE in the stop mode.

The operation indicator lights in red.

You do not need to press and hold ● REC/PAUSE while recording.

The new file will be automatically recorded after the last recorded file.

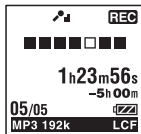
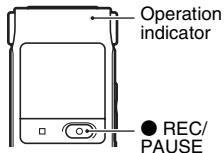

To stop recording

1 Press **■** STOP.

The “Accessing...” animation appears and the IC recorder stops at the beginning of the current recording file.



Note while accessing

The IC recorder is recording data and storing it on the memory media when the “Accessing...” animation appears on the display. While the IC recorder is accessing data, do not remove the battery or connect or disconnect the USB AC adaptor (not supplied). Doing so may damage the data.

Other operations

pause recording*	Press ● REC/PAUSE. During recording pause, the operation indicator flashes in red and “ ● ” begins to flash in the display window.
release pause and resume recording	Press ● REC/PAUSE again. Recording resumes from that point. (To stop recording after pausing recording, press ■ STOP.)
review the current recording instantly	Press ▶/ENT . Recording stops and playback starts from the beginning of the file just recorded.
review during recording	Press and hold ◀◀ on the control button during recording or recording pause. Recording stops and you can search backwards while listening to fast playback sound. After you release ◀◀ on the control button, playback starts from that point.

* 1 hour after you pause recording, recording pause is automatically released and the IC recorder enters the stop mode.

💡 Tips

- You can record up to 199 files in each folder.
- You can make new folders or erase unwanted folders using the supplied Sound Organizer software (page 90).

Listening





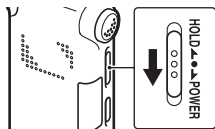

Starting playback

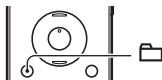
- 1** Slide the HOLD/POWER switch towards the center to release the IC recorder from the HOLD status (page 10).



- 2** Press .



- 3** Press  on the control button, press  or  on the control button to select the  (Voice) tab, the  (Music) tab, or the  (Podcast) tab, and then press  on the control button.

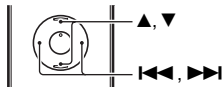

- 4** Press  or  on the control button to select the folder.

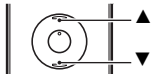

5 Press ►► on the control button.

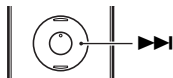

6 Press ▲ or ▼ on the control button to select the file you want to play.

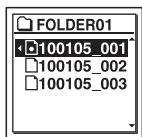

7 Press ►/ENT.

Playback will start soon, and the operation indicator will light in green. (When “LED” is set to “OFF” in the menu (page 76), the operation indicator does not light.)

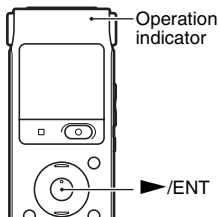

8 Press VOL -/+ to adjust the volume.



To stop playback

1 Press ■ STOP.



Other operations

stop at the current position (Playback Pause function) Press ►/ENT. To resume playback from that point, press ►/ENT again.

go back to the beginning of the current file Press ◀◀ on the control button once.*1*2

go back to previous files Press ◀◀ on the control button repeatedly. (During the stop mode, keep the button pressed to go back the files continuously.*3)

skip to the next file Press ▶▶ on the control button once.*1*2

skip to the succeeding files Press ▶▶ on the control button repeatedly. (During the stop mode, keep the button pressed to skip the files continuously.*3)

*1 When a track mark is set, the IC recorder goes backward or forward to the track mark before or after the current point (page 59).

*2 These operations are for when “Easy Search” is set to “OFF” (page 45).

*3 In the continuous searching mode, the IC recorder does not locate track marks.

About the tab view

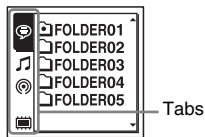

The recordable area and the playback-only area of folders stored on the IC recorder are managed separately, and are displayed with tabs. When you choose a folder, you can move to one of those the areas by switching a tab.







 (Voice): Recordable area. This is the area used to manage files recorded with the IC recorder.

 (Music): Playback-only area. This is the area used to manage music files transferred from your computer.

 (Podcast): Playback-only area. This is the area used to manage podcast files transferred from your computer.

 (Built-in memory) or  (External memory): You can switch between the built-in memory and external memory (memory card) of the IC recorder (page 38).

Only the  (Voice) tab will be displayed when you purchase the IC recorder.

The  (Music) tab and the  (Podcast) tab will be displayed when you transfer files from your computer (page 87, 91). The  (Built-in memory) tab will be displayed when you insert a memory card into the IC recorder (page 37).

Display when playing back a file

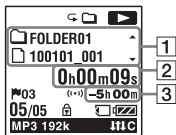

1 File information

Press ▲ or ▼ on the control button to check the file information during playback.
A file recorded using the IC recorder is displayed as follows.



 : Folder name: FOLDER01-FOLDER05

 : File name: Date_file number (e.g. 100101_001)



 : Artist name (e.g. My Recording)

 : Title: Date_file number (e.g. 100101_001)

2 Counter information

You can select the display mode in the menu (page 75).

Elapsed time: The elapsed playback time of one file

Remaining time: The remaining playback time of one file

Recording date: Date recorded

Recording time: Time recorded

3 Remaining recording time

Displays the remaining recording time in hours, minutes, and seconds.

If there is more than 10 hours time remaining, the time is displayed in hours.

If there is more than 10 minutes and less than 10 hours time remaining, the time is displayed in hours and minutes.

If there is less than 10 minutes time remaining, the time is displayed in minutes and seconds.

Erasing

■ Note

Once a recording has been erased, you cannot retrieve it.

Selecting a file and erasing it

- 1 Slide the HOLD/POWER switch towards the center to release the IC recorder from the HOLD status (page 10).

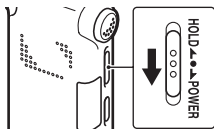

- 2 Select the file you want to erase when the IC recorder is in the stop or playback mode.

- 3 Press ERASE.
“Erase?” is displayed and the specified file is played back for confirmation.

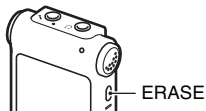

- 4 Press ▲ or ▼ on the control button to select “Execute.”

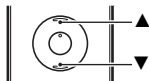

5 Press ►/ENT.

The “Erasing...” animation appears in the display window and the selected file will be erased.

When a file is erased, the remaining files will advance so that there will be no space between files.



To cancel erasing

1 Select “Cancel” in step 4 of “Selecting a file and erasing it,” and then press ►/ENT.

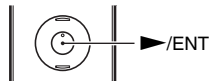

To erase another file

Proceed with steps 2 through 5 in “Selecting a file and erasing it.”

To erase a part of a file



Divide the file into two files first (page 62), and then proceed with steps 2 through 5 in “Selecting a file and erasing it.”

Changing the Recording Settings

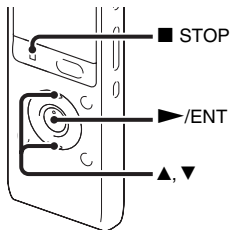
Selecting a recording scene for each situation





According to various recording scene, you can change the items for recording, such as REC Mode (page 70), Mic Sensitivity (page 70), etc., to the recommended settings in bulk. You can change the settings for each item.

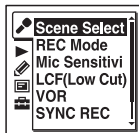

- 1 Select the  (Recording) tab → “Scene Select” in the menu, and then press  /ENT.

The Scene Select window will be displayed.







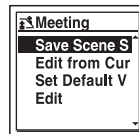

- 2 Press  or  on the control button to select a scene you want, and then press  /ENT.



- 3 Press  or  on the control button to select “Save Scene Setting,” and then press  /ENT.



- 4 Press  STOP to exit the menu mode.

 (Meeting)	To record in a variety of situations, such as recording in a spacious conference room.
 (Voice Notes)	To record dictation with a microphone in front of your mouth.
 (Interview)	To record human voice at a distance of 1 to 2 meters (40 to 80 in.).
 (Lecture)	To record a wide range of sound, such as a lecture in a classroom or a chorus lesson.
 (Audio IN)	To record from external equipment, such as a portable CD/MD player or a tape recorder, connected to the IC recorder via an audio output connector (stereo mini-jack). Also used for dubbing.
 (My Scene)	Use to keep your favorite settings.

Notes

- You cannot set a scene during recording.
- When 60 seconds have passed without any operation after the Scene Select display appeared in steps 1 through 3, the stop mode display will be displayed.

Tips for better recording

There are ways of making better recordings other than using scene selection.

Recording at a meeting

By placing the IC recorder on a stand or a handkerchief substituting for a stand, you can record with clear, low-noise sound, without vibration noise from the desk.

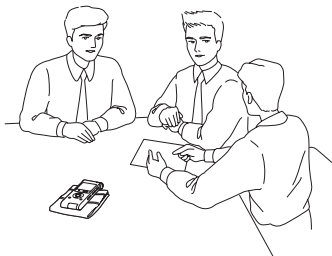

Recording a voice note

By placing the IC recorder close to one side of your mouth, you can prevent breathing on the built-in microphones, and record with clear sound.

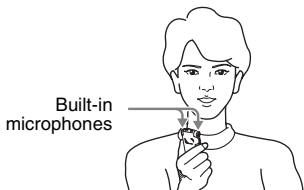

Recording an interview

Place the IC recorder so that the built-in microphones face the interviewee.



Recording a music performance

By attaching a tripod (not supplied) or placing the recorder on a stand or table, you can adjust the angle of the IC recorder and the built-in microphones more precisely. When recording a chorus or piano performance, for example, place the IC recorder on a table approximately 2 to 3 meters (80 to 120 in.) from the performer(s). Set up the IC recorder with the display window facing up, and with the built-in microphones pointing towards the sound source.

can adjust the angle of the IC recorder and the built-in microphones more precisely. When recording a chorus or piano performance, for example, place the IC recorder on a table approximately 2 to 3 meters (80 to 120 in.) from the performer(s). Set up the IC recorder with the display window facing up, and with the built-in microphones pointing towards the sound source.

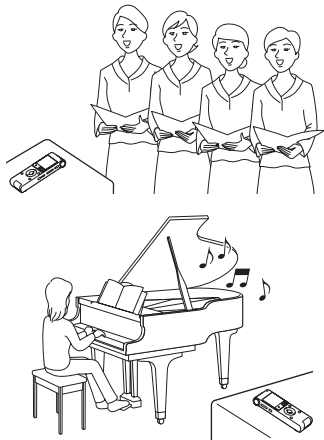

To change the settings when you set the scene

- 1 Select the scene you want to edit in step 2 of “Selecting a recording scene for each situation,” press ▲ or ▼ on the control button to select “Edit from Current Setting” or “Edit,” and then press ►/ENT.



- 2 Press ▲ or ▼ on the control button to select the menu item you want to change, and then press ►/ENT.



- 3 Press ▲ or ▼ on the control button to select a setting item, and then press ►/ENT.

For details on the menu items and settings, see pages 70 through 71.

- 4 Press ▲ or ▼ on the control button to select “Edit Complete,” and then press ►/ENT.



- 5 Press ■ STOP to exit the menu mode.

Note

Even if the settings are changed, the selection of the scene will be continued.

To set the menu item settings of the Scene Select to the default values

- 1 Select the scene you want to set the settings to the default value in step 2 of “Selecting a recording scene for each situation,” press ▲ or ▼ on the control button to select “Set Default Value,” and then press ►/ENT.



“Default Value?” will be displayed.







- 2** Press ▲ or ▼ on the control button to select “Execute,” and then press ►/ENT.



The menu item settings will be set to the default settings.







- 3** Press ■ STOP to exit the menu mode.

Default settings

For details on the menu items and settings, see pages 70 through 71.

	 (Meeting)	 (Voice Notes)	 (Interview)
REC Mode	MP3 192kbps	MP3 128kbps	MP3 192kbps
Mic Sensitivity	High 	Low 	Medium 
LCF(Low Cut)	ON	ON	ON
VOR	OFF	OFF	OFF

	 (Meeting)	 (Voice Notes)	 (Interview)
SYNC REC	OFF	OFF	OFF
Select Input	MIC IN	MIC IN	MIC IN

	 (Lecture)	 (Audio IN)	 (My Scene)
REC Mode	MP3 192kbps	MP3 192kbps	MP3 192kbps
Mic Sensitivity	Medium 	Low 	Medium 
LCF(Low Cut)	OFF	OFF	OFF
VOR	OFF	OFF	OFF
SYNC REC	OFF	ON	OFF
Select Input	MIC IN	Audio IN	MIC IN

Starting to record automatically in response to sound – the VOR function

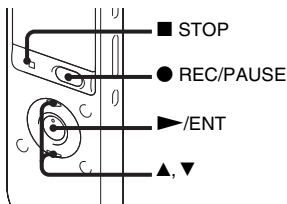

You can set the VOR (Voice Operated Recording) function to “ON,” to make the IC recorder start recording when the IC recorder detects sound, and pause when no sound is heard, eliminating recording during soundless periods.

- 1 Select the (Recording) tab → “VOR” in the menu when the IC recorder is in the stop or recording mode, and then press ▶/ENT.



- 2 Press ▲ or ▼ on the control button to select “ON,” and then press ▶/ENT. “VOR” is set to “OFF” when you purchase the IC recorder.

- 3 Press ■ STOP to exit the menu mode.

- 4 Press ● REC/PAUSE.
“VOR ” appears in the display window.

The recording pauses when no sound is detected and “VOR ” flashes. When the IC recorder detects sound again, the recording starts again.

To cancel the VOR function

Set “VOR” to “OFF” in step 2.

Notes

- The VOR function is affected by the sound around you. Set “Mic Sensitivity” in the menu according to the recording conditions. If recording is not satisfactory after you have changed the “Mic Sensitivity” setting, or for an important recording, set “VOR” to “OFF” in the menu.
- If you press ● REC/PAUSE to pause recording during VOR recording, only “ ” flashes.
- During synchronized recording (page 42), the VOR function does not work.

Recording on a Memory Card

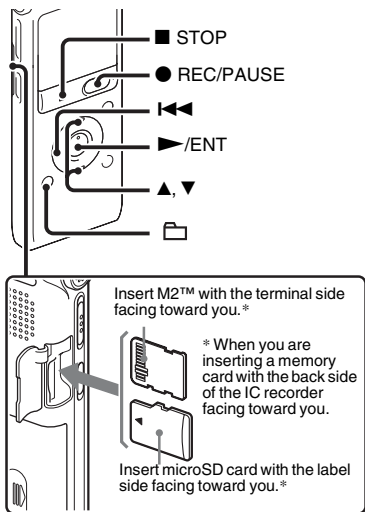

In addition to the built-in memory, you can record files on a memory card.

About compatible memory cards

Memory cards that you can use with the IC recorder are as follows:

- Memory Stick Micro™ (M2™) media: Up to 16 GB is supported.
 - microSD card: A microSD (FAT16) card smaller than 2 GB and a microSDHC (FAT32) card from 4 GB to 32 GB are supported.
- A memory card of 64 MB or less is not supported.

The microSD/microSDHC cards that have been tested according to our standards are as follows.

microSD/microSDHC cards

Supplier	2 GB	4 GB	8 GB	16 GB	32 GB
SONY	○	○	○	—	—
Toshiba	○	○	○	○	—
Panasonic	○	○	○	○	—
SanDisk	○	○	○	○	○

○: Operation tested

—: Operation not tested

As of September 2010

For ICD-UX512, the operational tests performed were using memory cards available as of September 2010.

For the latest information about the memory cards that have been tested, please access the support home page for the IC recorder:
<http://www.sony.com/recordersupport>

In this manual, M2™ and microSD cards are generally referred to as a “memory card.”

The M2™/microSD card slot is referred to as the “memory card slot.”

Due to the file system specifications of the IC recorder, you can record and play back an LPCM file smaller than 2 GB, and an MP3/WMA/AAC-LC file smaller than 1 GB using a memory card.

You can record up to 4,074 files on an M2™ media.

Note

Operations of all types of compatible memory cards are not guaranteed.

To insert a memory card

Before recording, be sure to copy all the data stored on the memory card to your computer and format the memory card on the IC recorder (page 79) so it contains no data.

- 1** Open the cover of the memory card slot in the stop mode.

- 2** Insert an M2™ or microSD card, in the direction shown in the illustration on page 36, securely to the end of the slot until it clicks into place. Then close the cover.

To remove a memory card

Push the memory card into the slot. When it pops out, remove it from the memory card slot.

Structure of folders and files









5 folders are created in a memory card in addition to those in the built-in memory. The structure of folders and files is somewhat different from that of the built-in memory (page 83).

Notes



- Do not insert or remove a memory card during recording/playback/formatting. Doing so may cause a malfunction of the IC recorder.
- Do not remove a memory card while the “Accessing...” animation appears in the display window. Doing so may damage the data.
- If a memory card is not recognized, remove it and then insert it into the IC recorder again.
- Close the cover of the memory card slot firmly. Also, do not insert any liquid, metal, flammable or any object other than a

memory card into the slot. Doing so may cause fire, electric shock, or malfunctions.

To switch the IC recorder destination to the memory card (from the folder selection window)

- 1 Press .
The folder selection window will be displayed.
- 2 Press  on the control button, press  or  on the control button to select the  (Built-in memory) tab, and then press /ENT.
- 3 Press  or  on the control button to select “Memory Card,” and then press /ENT.



The  (Built-in memory) tab changes to the  (External memory) tab, and then the folder selection window will be displayed.

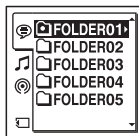



- 4 Press  STOP to return to the stop mode display.

To use the built-in memory

Select “Built-In Memory” in step 3.

To switch the IC recorder destination to the memory card (from the menu)

- 1 Select the  (IC recorder setting) tab → “Select Memory” in the menu, and then press /ENT.

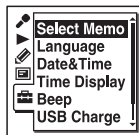

- 2 Press ▲ or ▼ on the control button to select “Memory Card,” and then press ►/ENT.



“Select Memory” is set to “Built-In Memory” when you purchase the IC recorder.

If the memory card has already been formatted, proceed to step 5.

- 3 When the memory card is not formatted, select the  (IC recorder setting) tab → “Format” in the menu, and then press ►/ENT.
“Erase All Data?” will be displayed.

- 4 Press ▲ or ▼ on the control button to select “Execute,” and then press ►/ENT.
- 5 Press ■ STOP to exit the menu mode.

To use the built-in memory

Select “Built-In Memory” in step 2.

To start recording

Select the folder and then press ● REC/PAUSE. For details on recording, see page 19.

Recording via Other Devices

Recording with an external microphone

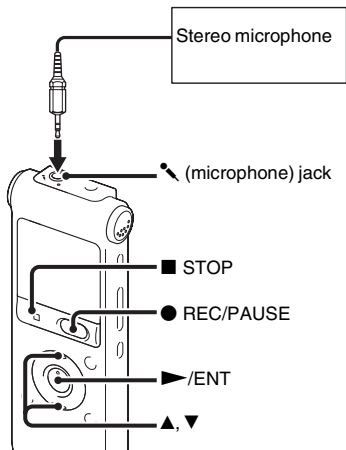

- 1 Connect an external microphone to the (microphone) jack when the IC recorder is in the stop mode. “Select Input” appears in the display window.

If “Select Input” is not displayed, set it in the menu (page 71).

- 2 Press ▲ or ▼ on the control button to select “MIC IN,” and then press ▶ / ENT.



“Select Input” is set to “MIC IN” when you purchase the IC recorder.

- 3 Press ■ STOP to exit the menu mode.
- 4 Press ● REC/PAUSE to start recording.

The built-in microphones are automatically cut off.

If the input level is not strong enough, adjust the “Mic Sensitivity” setting on the IC recorder.

When a plug in power type microphone is connected, power is automatically supplied to the microphone from the IC recorder.

💡 Recommended microphones

You can use the Sony ECM-CS10, ECM-CZ10 electret condenser microphone (not supplied).

To record sound from a telephone or a cell phone

You can use the ECM-TL1 headphone-type electret condenser microphone (not supplied) to record sound from a telephone or a cell phone.

For details on how to make the connection, refer to the operating instructions supplied with the ECM-TL1 microphone.

📌 Notes

- After you have made the connection, check the sound quality of the conversation and the recording level before you start recording.
- If the beep of the telephone or a dial tone is recorded, the conversation may be recorded with lower level of sound. In this case, start recording after the conversation has started.
- The VOR function (page 35) may not work, depending on the kind of telephone or the line condition.
- We assume no responsibility whatsoever for any inconvenience, even if you cannot record a conversation using the IC recorder.

Recording from other equipment

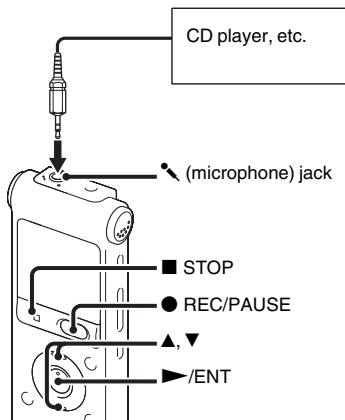

You can make music files without using the computer by recording sound from other equipment connected to the IC recorder. When you select “Audio IN” from the “Scene Select” menu, the settings suitable for recording from other equipment are already selected. For details on setting, see page 30.



💡 Tips

- Before you start recording, we recommend you make a trial recording first.
- If the input level is not strong enough, connect the headphone jack (minijack, stereo) of other equipment to the  (microphone) jack of the IC recorder and adjust the volume level on the piece of equipment connected to the IC recorder.



To record using the synchronized recording function

The IC recorder pauses when no sound is detected for more than 2 seconds. The IC recorder starts recording again as a new file when sound is detected.

When you select “Audio IN” from the “Scene Select” menu, the “SYNC REC” is already set to “ON.”

- 1 Select the  (Recording) tab → “SYNC REC” in the menu, and then press .



- 2 Press  or  on the control button to select “ON,” and then press .

“SYNC REC” is set to “OFF” when you purchase the IC recorder.



- 3 Press  STOP to exit the menu mode.

- 4 Connect other equipment to the IC recorder when the IC recorder is in the stop mode.

Connect the audio output connector (stereo mini-plug) of other equipment to the  (microphone) jack of the IC recorder using an audio connecting cable (page 54).

“Select Input” appears in the display window.

If “Select Input” is not displayed, set it in the menu (page 71).

- 5 Press  or  on the control button to select “Audio IN,” and then press /ENT.

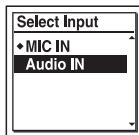

“Select Input” is set to “MIC IN” when you purchase the IC recorder.

6 Press ● REC/PAUSE to start recording. “SYNC  ” flashes and the IC recorder enters the recording pause mode.

7 Start playback on the piece of equipment connected to the IC recorder.

“SYNC  ” appears on the display and synchronized recording starts.

The synchronized recording pauses when no sound is detected for more than 2 seconds, and “SYNC  ” begins to flash. The IC recorder starts recording again as a new file when sound is detected.

Notes

- During synchronized recording, you cannot pause recording (page 22), record with the VOR function (page 35), and add a track mark (page 59).
- Depending on the piece of equipment connected to the IC recorder, the synchronized recording function may not operate properly due to a difference in the audio input level.
- When recording from other equipment, the “Mic Sensitivity” setting cannot be changed.

To record without using the synchronized recording function

Select “OFF” in step 2 of “To record using the synchronized recording function” on page 42, and then proceed with steps 3 through 7. When you press ● REC/PAUSE in step 6, the built-in microphones are automatically cut off and the sound from the connected piece of equipment is recorded.

Operation during Recording

Monitoring the recording

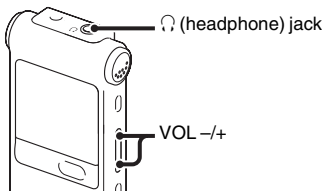

If you connect the supplied stereo headphones to the  (headphone) jack, you can monitor the recording. You can adjust the monitoring volume by pressing VOL -/+, but the recording level is fixed.



Note

When the cord of the headphones touches the IC recorder while you are monitoring the recording, the IC recorder may record a rustling noise. The rustling noise can be reduced by holding the cord away from the IC recorder.





Changing the Playback Settings

Convenient playback methods



Listening with better sound quality

- To listen with the headphones:
Connect the supplied stereo headphones to the  (headphone) jack. The built-in speaker will be automatically disconnected.
- To listen from an external speaker:
Connect an active or passive speaker (not supplied) to the  (headphone) jack.

Quickly locating the point you wish to start playback (Easy search)

When “Easy Search” is set to “ON” (page 73) in the menu, you can quickly locate the point at which you wish to start playback by pressing  or  on the control button repeatedly during playback. You can go back approx. 3 seconds by pressing  on the control button once, or advance approx. 10 seconds by pressing  on the control button once. This function is useful for locating a desired point in a long recording.

Searching forward/backward during playback (Cue/Review)

- To search forward (Cue):
Press and hold  on the control button during playback and release it at the point you wish to resume playback.
- To search backward (Review):
Press and hold  on the control button during playback and release it at the point you wish to resume playback.

The IC recorder searches at slow speed with playback sound. This is useful to check one word forward or back. Then, if you press and hold the button, the IC recorder starts to search at higher speed.

When files are played back to the end of the last file

- When you play back or fast play back to the end of the last file, “FILE END” lights up for approx. 5 seconds.
- When “FILE END” and the operation indicator go off, the IC recorder will stop at the beginning of the last file.
- If you press and hold  on the control button while “FILE END” is lit, the files are played back rapidly, and normal playback will start at the point you release the button.

- If the last file is long and you wish to start playback at a later part of the file, press and hold ►► on the control button to go to the end of the file, and then press ◀◀ on the control button while “FILE END” is lit to go back to the desired point.
- For files other than the last one, go to the beginning of the next file and play backward to the desired point.

Reducing noise in the playback sound and making the human voice clearer – the noise cut function

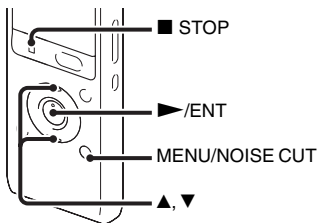

When the noise cut function is effective in the playback mode, ambient noise other than the human voice is reduced. A file is played back with clear sound quality because the noise of all frequency bands including a human voice is reduced.

Notes

- The effect of the noise cut function may be different depending on the condition of the recorded voice.
- When you are using the built-in speaker, the noise cut function does not work.
- When the noise cut function is effective, the effect function does not work.
- When you are listening an AAC-LC and WMA file, the noise cut function does not work.

- 1 Press and hold MENU/NOISE CUT for approximately 2 seconds or longer when the IC recorder is in the stop or playback mode.

The “Noise Cut” setting window will be displayed.

- 2 Press ▲ or ▼ on the control button to select “Maximum” or “Medium,” and then press ►/ENT.

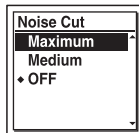

“Noise Cut” is set to “OFF” when you purchase the IC recorder.

3 Press ■ STOP to exit the menu mode.

To cancel the noise cut function

Select “OFF” in step 2.

To set the noise cut function in the menu

Select and set “Noise Cut” from the ► (Playback) tab of the menu.

Adjusting the playback speed – the DPC (Digital Pitch Control) function

Rear

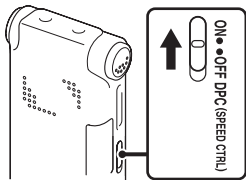

Front

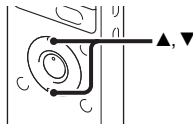

You can adjust the playback speed in a range from 0.50 times to 2.00 times. The file is played back in natural tones by means of a digital processing function.

1 Slide the DPC(SPEED CTRL) switch to “ON.”

2 During playback, press ▲ or ▼ on the control button to adjust the playback speed.

▼: Decreases the speed by 0.05 times each time this button is pressed (from $\times 0.50$ to $\times 1.00$).

▲: Increases the speed by 0.10 times each time this button is pressed (from $\times 1.00$ to $\times 2.00$).

When you press and hold each button, you can change the speed continuously.

The playback speed is set to “×0.70” when you purchase the IC recorder.

To resume normal playback speed

Slide the DPC(SPEED CTRL) switch to “OFF.”

Note

You can only adjust the playback speed in a range from 0.50 times to 1.00 time when files are recorded as LPCM/WMA/AAC-LC files. If you attempt to adjust the playback speed beyond this range, “NO FAST” appears in the display window.

Selecting the sound effect

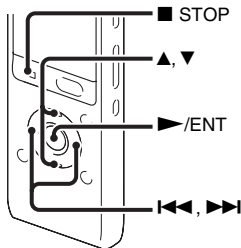

You can set the effect you want for the playback in the menu.

- 1 Select the ► (Playback) tab → “Effect” in the menu when the IC recorder is in the stop or playback mode, and then press ►/ENT.



- 2 Press ▲ or ▼ on the control button to select effect you want for the playback, and then press ►/ENT.



- 3 Press ■ STOP to exit the menu mode.

Pop	Stresses middle ranges, ideal for vocals.
Rock	Emphasizes high and low ranges for a powerful sound.
Jazz	Emphasizes high ranges for lively sound.
Bass1	Emphasizes the bass sound.
Bass2	Emphasizes the bass sound even more.
Custom	You can design your own custom sound level for 5 bands.
OFF	Disables the effect function.

“Effect” is set to “OFF” when you purchase the IC recorder.

To set your favorite sound level

- 1 Set “Effect” to “Custom” in step 2, and then press ►/ENT.

The custom setting window will be displayed.

- 2 When you adjust the sound level for the 100 Hz, 300 Hz, 1 kHz, 3 kHz, and 10 kHz bands, press ◀◀ or ▶▶ on the control button to move to the band to the left or right, and then press ▲ or ▼ on the control button.

The setting can be adjusted in 7 steps from -3 to +3.

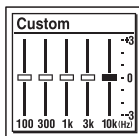

- 3 Press ►/ENT.

- 4 Press ■ STOP to exit the menu mode.

■ Notes

- When you are using the built-in speaker, this setting is invalid.
- When the noise cut function is effective, the effect function does not work.

Selecting the playback mode

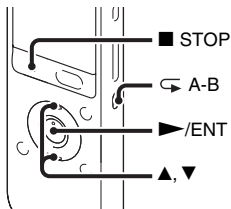

You can select the playback mode in the menu.

- 1 Select the ► (Playback) tab → “Play Mode” in the menu when the IC recorder is in the stop or playback mode, and then press ►/ENT.



- 2 Press ▲ or ▼ on the control button to select “1,” “📁,” “ALL,” “◀ 1,”

“◀ 📁,” or “◀ ALL,” and then press ►/ENT.

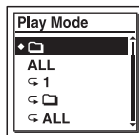



- 3 Press ■ STOP to exit the menu mode.

1	A file is played back.
📁	Files in one folder are played back continuously.
ALL	All the files are played back continuously.
◀ 1	One file is played back repeatedly.
◀ 📁	Files in one folder are played back repeatedly.
◀ ALL	All the files are played back repeatedly.

“Play Mode” is set to “📁” when you purchase the IC recorder.

To play back a specified section repeatedly – A-B repeat

- 1** During playback, press  (repeat) A-B to specify the starting point A.
“A-B B?” is displayed.
- 2** Press  (repeat) A-B again to specify the finishing point B.
“ A-B” is displayed and the specified section is played back repeatedly.

To resume normal playback:

Press /ENT.

To stop A-B repeat playback:

Press  STOP.

To change the segment specified for A-B repeat playback:

During A-B repeat playback, press  (repeat) A-B again to specify a new starting point A. Then specify a new finishing point B, as in step 2.

Note

You cannot set the points A and B near the beginning of a file or the end of a file, and around track mark.

Playing Back a File at a Desired Time with an Alarm

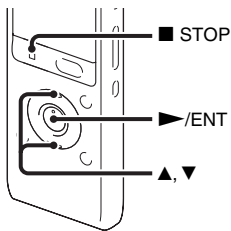

You can sound an alarm and start playback of a selected file at a desired time. You can have a file played back on a specified date, once every week, or at the same time every day. You can set an alarm for a file.

- 1 Select the file you want to play back with an alarm.
- 2 Enter the alarm setting mode.
 - ① Select the ► (Playback) tab → “Alarm” in the menu when the IC recorder is in the stop mode, and then press ►/ENT.



- ② Press ▲ or ▼ on the control button to select “ON,” and then press ►/ENT.

3 Set the alarm date and time.

- ① Press ▲ or ▼ on the control button to select “Date,” a day of the week, or “Daily,” and then press ►/ENT.
- ② **When you select “Date”:**
Set the year, month, day, hour, and minute in sequence, as described in “Step 4: Setting the Clock” on page 15.
When you select a day of the week or “Daily”:
Press ▲ or ▼ on the control button to set the hour, and then press ►/ENT, press ▲ or ▼ on the control button to set the minute, and then press ►/ENT.

- 4 Press ▲ or ▼ on the control button to select a favorite alarm pattern, and then press ►/ENT.



“Executing...,” is displayed.

- 5** Press **■** STOP to exit the menu mode. The setting process is finished and “(●)” (alarm indicator) appears in the display window.

To change the alarm setting

Select the file you want to change its alarm setting, and then follow steps 2 through 5 on page 52 through this page.

To cancel the alarm setting

Follow steps 1 and 2 on page 52. In step 2-② select “OFF” and press **▶/ENT**. The alarm will be canceled and the alarm indicator will disappear from the display window.

When the set date and time comes

At the set time, “ALARM” is displayed in the display window and the alarm and the selected file will be played back using the selected alarm pattern.

When the playback ends, the IC recorder will stop automatically. (When the alarm pattern is set to “Beep&Play” or “Play,” the IC recorder will stop at the beginning of the selected file.)

To stop the alarm playback

Press any button other than VOL **-/+** while the alarm sound is heard. If the HOLD function is activated, you can stop the alarm playback by pressing any button.

■ Notes

- You can set only one alarm each one file.
- When the clock has not been set or no files are recorded, you cannot set the alarm.
- The alarm sounds even if you set “Beep” to “OFF” in the menu (page 77).
- If the alarm time comes while you are updating data, the alarm will be canceled automatically.
- If more than one alarm time comes, only the first file will be played back with an alarm.
- If you divide a file you have set an alarm for, the alarm setting remains on only the first part of the divided file.
- If you erase a file in which you have set an alarm, that alarm will be also canceled.
- You cannot set alarm in podcast files.
- You cannot set an alarm in the files stored on a memory card.

Playback via Other Devices

Recording with other equipment

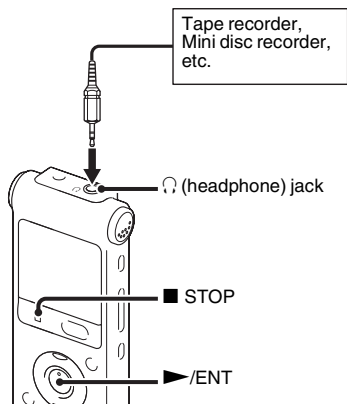

You can record the sound of the IC recorder with other equipment.

Before you start recording, we recommend you make a trial recording first.

- 1 Connect the (headphone) jack of the IC recorder to the external input terminal

of other equipment using an audio connecting cable.*

- 2 Press ▶/ENT to start playback and at the same time set the connected equipment to the recording mode. A file from the IC recorder will be recorded on the equipment connected.

- 3 Press ■ STOP on the IC recorder and the connected equipment at the same time to stop recording.

💡 Tip

If the volume of the recorded sound is not strong enough, adjust the playback sound of the IC recorder (page 24).

* Optional audio connecting cables (not supplied)



	To the IC recorder	To the other equipment
RK-G139	Stereo mini-plug*	Mini-plug (monaural)*
RK-G136	Stereo mini-plug*	Stereo mini-plug*

*(without resistor)



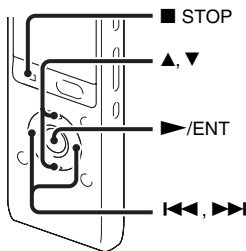



Arranging Files in a Folder

Moving a file to a different folder





- 1 Select the file you want to move.
- 2 Select the  (Edit) tab → “Move File” in the menu when the IC recorder is in the stop mode, and then press /ENT.



- 3 Press  on the control button, press  or  on the control button to select the  (Voice) tab or the  (Music) tab, and then press .



- 4 Press  or  on the control button to select the folder that you want to move the file into, and then press /ENT.

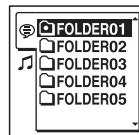

“Moving File...” animation is displayed and the file is moved to the last position in the destination folder.

When you move a file to another folder, the original file in the previous folder will be erased.

- 5 Press  STOP to exit the menu mode.

To cancel moving the file

Press ■ STOP before step 4.

■ Notes

- You cannot move podcast files.
- You cannot move protected files (page 65).
- You cannot move files to the other memory media.

Copying a file to the other memory

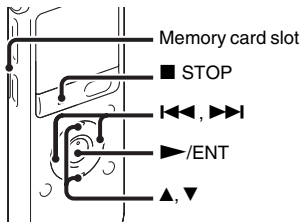

You can copy files between the built-in memory and a memory card, which is useful in saving a backup. Before starting the operation, insert a memory card to be used for copying into the memory card slot.



- 1 Select the file you want to copy.

When you want to copy a file from a memory card to the built-in memory, set the source memory media to “Memory Card” (page 38).

- 2 Select the  (Edit) tab → “File Copy” in the menu, and then press ►/ENT.



The “Copy to Memory Card Select Folder” or the “Copy to Built-In Memory Select Folder” animation appears and the folder selection window is displayed.

- 3 Press ◀◀ on the control button, press ▲ or ▼ on the control button to select the  (Voice) tab or the  (Music) tab, and then press ▶▶.



- 4 Press ▲ or ▼ on the control button to select the folder that you want to copy the file into, and then press ►/ENT.



The “Copying...” animation appears and the file is copied as the last file in the destination folder. A file will be copied with the identical file name.

- 5 Press ■ STOP to exit the menu mode.

To cancel the copy operation

Press ■ STOP before step 4.

To cancel the copy operation during copying

While the “Copying...” animation is displayed in step 4, press ■ STOP.

■ Notes

- Before starting to copy the target file, make sure to check the battery indicator. If the battery is weak, you may not be able to copy files.
- If the remaining memory capacity of the destination memory media is insufficient, you may not be able to copy files.

- You cannot copy the podcast files.
- Do not remove or insert a memory card, or turn off the IC recorder while copying. Files may be damaged.

Erasing all files in a folder

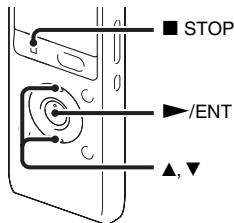

■ Note

If the selected folder contains a protected file (page 65), you cannot erase the protected file in that folder.

- 1 Select the folder containing the files you want to erase when the IC recorder is in the stop mode.

- 2 Select the  (Edit) tab → “Erase All” in the menu, and then press **▶/ENT**.



“Erase All Files in the Folder?” will be displayed.

- 3 Press **▲** or **▼** on the control button to select “Execute,” and then press **▶/ENT**.

The “Erasing...” animation appears in the display window and all files in the selected folder will be erased.

- 4 Press **■** STOP to exit the menu mode.

To cancel erasing

Select “Cancel” in step 3, and then press **▶/ENT**.

Using a Track Mark

Adding a track mark

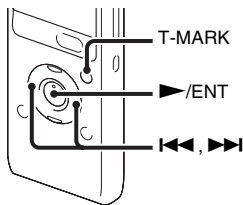

You can add a track mark at a point at which you would like to divide a file later or locate during playback. You can add a maximum of 98 track marks to each file.

During recording, playing back, or pausing, press T-MARK at the position you want to add a track mark.



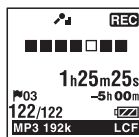

The  (Track mark) indicator flashes three times, and a track mark is added.



Notes



- You can add a track mark only to files recorded using the IC recorder. However, when you edit files using the supplied Sound Organizer software, adding a track mark to the files may not be possible.
- You cannot add a track mark at a point within 0.5 seconds from another track mark.
- You cannot add a track mark at the very beginning or at the very end of the file.
- If there are already 98 track marks in a file, you cannot add any more track marks.
- When a track mark is added during playback, the playback stops.

Locating a track mark and starting playback at the track mark

Press  or  on the control button in the stop mode. When the  (Track mark) indicator flashes once, press /ENT.

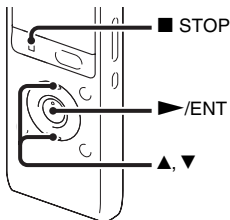

Erasing a track mark



- 1 Stop at a position after the track mark you would like to erase.
- 2 Select the  (Edit) tab → “Erase Track Mark” in the menu, and then press  / ENT.



“Erase Track Mark?” will be displayed.

- 3 Press  or  on the control button to select “Execute,” and then press  / ENT.

The “Erasing...” animation appears in the display window and the selected track mark will be erased.

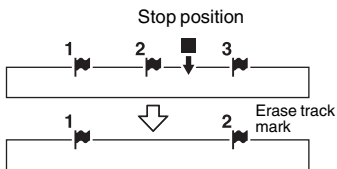

The track mark just before the stop position will be erased.



- 4 Press  STOP to exit the menu mode.

To cancel erasing

Select “Cancel” in step 3, and then press  / ENT.

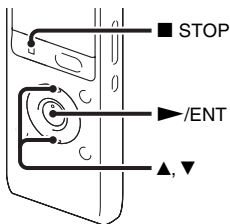

Erasing all the track marks in the selected file at one time



- 1 Select a file from which you want to erase the track marks.
- 2 Select the  (Edit) tab → “Erase All Track Marks” in the menu, and then press /ENT.



“Erase All Track Marks?” will be displayed.

- 3 Press  or  on the control button to select “Execute,” and then press /ENT.

The “Erasing...” animation appears in the display window and all the track marks will be erased at one time.

- 4 Press  STOP to exit the menu mode.

To cancel erasing

Select “Cancel” in step 3, and then press /ENT.

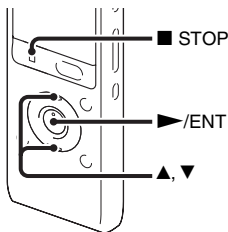

Dividing a File

Dividing a file at the current position





You can divide a file in the stop mode, so that the file is divided into two parts and a new file number is added to the newer part of the divided file. By dividing a file, you can easily find the point from which you want to play back when you make a long recording such as at a meeting. You can divide a file until the total number of files in the folder reaches the maximum number allowed.

- 1 Stop the file at the position where you want to divide a file.

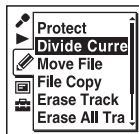
- 2 Select the  (Edit) tab → “Divide Current Position” in the menu, and then press /ENT.



“Divide?” will be displayed.

- 3 Press  or  on the control button to select “Execute,” and then press /ENT.

The “Dividing...” animation appears, and the divided files will be suffixed with a sequential number (“_1” for the original file, and “_2” for the new file).

File 1	File 2	File 3	
	 A file is divided.		
File 1	File 2_1	File 2_2	File 3

A suffix made up of a sequential number is added to each of the divided files.

- 4 Press  STOP to exit the menu mode.

Notes

- You need a certain amount of free space in the memory media to divide a file.
- When you divide a file with a title and artist name, the newer part has the same title, and artist name.
- You cannot divide files other than those recorded using the IC recorder (e.g., a file transferred from a computer). Moreover, when you edit files using the supplied Sound Organizer software, dividing files may not be possible.
- Once a file is divided, you cannot return it to the original status again.
- If you divide a file at the position within 0.5 seconds from a track mark, the track mark will be erased.
- Because of the system limitations, you cannot divide a file at the very beginning or at the very end of the file.

To cancel dividing

Select “Cancel” in step 3, and then press ►/ENT.

Dividing a file at all the track mark positions

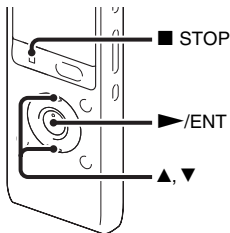

- 1 Select the file you want to divide.
- 2 Select the  (Edit) tab → “Divide All Track Marks” in the menu when the IC recorder is in the stop mode, and then press ►/ENT.



“Divide All Track Marks?” will be displayed.

3 Press ▲ or ▼ on the control button to select “Execute,” and then press ►/ENT.

The “Dividing...” animation appears, and the file is divided at all the track mark positions. All the existing track marks in the files will be erased.

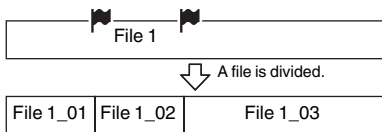

A suffix made up of a sequential number is added each of the divided files.

4 Press ■ STOP to exit the menu mode.

To cancel dividing

Select “Cancel” in step 3, and then press ►/ENT.

Tip

To cancel division during the operation at all the remaining track marks, press ■ STOP. The files that have been divided before the cancellation remain divided.



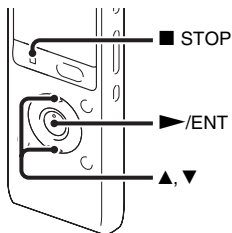

Notes

- You need a certain amount of free space in the memory media to divide a file.
- When you divide a file with a title and artist name, the newer part has the same title, and artist name.
- You cannot divide files other than those recorded using the IC recorder (e.g., a file transferred from a computer). Moreover, when you edit files using the supplied Sound Organizer software, dividing files may not be possible.
- Once a file is divided, you cannot return it to the original status again.

Protecting a File







To prevent a file from being accidentally erased or edited, you can protect an important file. A protected file is marked with the  (protect) indicator and is regarded as a read-only file you cannot erase or edit.

- 1 Display the file which you want to protect from the  (Voice) tab or the  (Music) tab.
- 2 Select the  (Edit) tab → “Protect” in the menu when the IC recorder is in the stop mode, and then press /ENT.



“Set Protection?” will be displayed.

- 3 Press  or  on the control button to select “Execute,” and then press /ENT.

The file is protected. A protected file is marked with the  (protect) indicator.

- 4 Press  STOP to exit the menu mode.

To release protection

Select the protected file, and then proceed with steps 2 through 4. In this case, “Erase Protection?” will be displayed in step 2.

Note

You cannot set protection to the files in the  (Podcast) tab.

Making Settings for the Menu

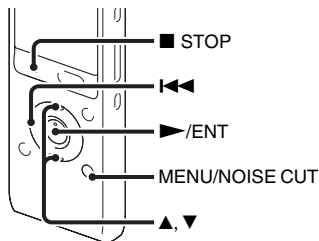

- 1 Press MENU/NOISE CUT to enter the menu mode.

The menu mode window will be displayed.



- 2 Press **◀◀** on the control button, press **▲** or **▼** on the control button to select the **🎤** (Recording) tab, the **▶** (Playback) tab, the **✎** (Edit) tab, the **📺** (Display) tab, or the **📷** (IC recorder setting) tab, and then press **▶/ENT**.

- 3 Press **▲** or **▼** on the control button to select the menu item for which you want to make setting, and then press **▶/ENT**.

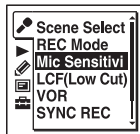

- 4 Press **▲** or **▼** on the control button to select the setting that you want to set, and then press **▶/ENT**.

- 5 Press **■** STOP to exit the menu mode.

Note

If you do not press any button for 60 seconds, the menu mode is automatically canceled and the window will return to the normal display.



To return to the previous window



Press **◀◀** on the control button during menu mode.









To exit the menu mode





Press **■** STOP or MENU/NOISE CUT.



Menu Settings

Tabs	Menu items	Operation mode		
		(○: the setting can be made / —: the setting cannot be made)		
		Stop mode	Playback mode	Recording mode
 (Recording)	Scene Select	○	—	—
	REC Mode	○	—	—
	Mic Sensitivity	○	—	○
	LCF(Low Cut)	○	—	○
	VOR	○	—	○
	SYNC REC	○	—	—
	Select Input	○	—	—
 (Playback)	Noise Cut	○	○	—
	Effect	○	○	—
	Easy Search	○	○	—
	Play Mode	○	○	—
	Alarm	○	—	—
 (Edit)	Protect	○	—	—
	Divide Current Position	○	—	—
	Move File	○	—	—
	File Copy	○	—	—
	Erase Track Mark	○	—	—
	Erase All Track Marks	○	—	—
	Divide All Track Marks	○	—	—
	Erase All	○	—	—



Tabs	Menu items	Operation mode		
		(○: the setting can be made / —: the setting cannot be made)		
		Stop mode	Playback mode	Recording mode
 (Display)	Display	○	○	○
	LED	○	—	—
	Backlight	○	—	—
 (IC recorder setting)	Select Memory	○	—	—
	Language	○	—	—
	Date&Time	○	—	—
	Time Display	○	—	—
	Beep	○	—	—
	USB Charge	○	—	—
	Auto Power Off	○	—	—
	Format	○	—	—



Tabs	Menu items	Settings (*: Initial setting)	See page
 (Recording)	Scene Select	<p>Allows you to choose a recording scene item for each situation as follows:  (Meeting),  (Voice Notes),  (Interview),  (Lecture),  (Audio IN),  (My Scene). You can also edit the settings of the various recording menu items which are pre-set in the “Scene Select” menu.</p> <p>Save Scene Setting Saves the changed settings and completes the menu operation process.</p> <p>Edit from Current Setting: Changes the settings that is pre-set in the menu.</p> <p>Set Default Value: Changes the settings to the default settings. Execute: Changes the settings to the default settings and completes the process. Cancel: Completes the process without changing the settings.</p> <p>Edit: Changes the settings from the settings in the selected scene item.</p> <p> Tip You can edit the following menu items: “REC Mode” (page 70), “Mic Sensitivity” (page 70), “LCF(Low Cut)” (page 71), “VOR” (page 35) “SYNC REC” (page 42), “Select Input” (page 40). When you select “Edit Complete,” the process will be completed.</p>	30



Tabs	Menu items	Settings (*: Initial setting)	See page
 (Recording)	REC Mode	Sets the recording mode. LPCM 44.1kHz/16bit: LPCM (not compressed) in stereo high-quality recording mode MP3 192kbps*: MP3 (compressed) in stereo standard-quality recording mode MP3 128kbps: MP3 (compressed) in long play stereo recording mode MP3 48kbps(MONO): MP3 (compressed) in monaural standard recording mode MP3 8kbps(MONO): MP3 (compressed) in long play monaural recording mode	–
	Mic Sensitivity	Sets the microphone sensitivity. High  To record a sound far away from the IC recorder or a low sound, such as recording in a spacious room. Medium  *: To record the sound of a normal conversation or meeting, such as recording in a meeting space or during interview. Low  To record dictation with a microphone in front of your mouth, a sound near the IC recorder, or a loud sound.	–



Tabs	Menu items	Settings (*: Initial setting)	See page
 (Recording)	LCF (Low Cut)	Sets the LCF (Low Cut Filter) function to cut a low frequency to reduce the roaring noise from wind; therefore you can record a file more clearly. ON: The LCF function is activated. OFF*: The LCF function is canceled.	–
	VOR	Sets the VOR (Voice Operated Recording) function. ON: Recording starts when the IC recorder detects sound and pauses when no sound is heard, eliminating recording during soundless periods. The VOR function is activated when ● REC/PAUSE is pressed. OFF*: The VOR function does not work.	35
	SYNC REC	When set to “ON,” the IC recorder enters the recording pause mode when no sound is detected for more than 2 seconds, and the IC recorder starts recording again as a new file when any sound is detected. ON: The synchronized recording function is activated. OFF*: The synchronized recording function is canceled.	42
	Select Input	Selects the external input to be recorded that is connected to the  (microphone) jack. MIC IN*: Select when you record files using an external microphone. Audio IN: Select when you record using other equipment.	40, 41

Tabs	Menu items	Settings (*: Initial setting)	See page
▶ (Playback)	Noise Cut	<p>Sets the noise cut function and the noise cut level to use when the IC recorder play a file back which is recorded with noise cut function.</p> <p>Maximum: The noise cut levels will be more intense.</p> <p>Medium: The noise cut level will be weakened. Select when you cannot catch the sound easily by setting “Noise Cut” to “Maximum.”</p> <p>OFF*: The noise cut function is canceled.</p>	46
	Effect	<p>Sets the effect you want for the playback.</p> <p>Pop: Stresses middle ranges, ideal for vocals.</p> <p>Rock: Emphasizes high and low ranges for a powerful sound.</p> <p>Jazz: Emphasizes high ranges for lively sound.</p> <p>Bass1: The bass sound is emphasized.</p> <p>Bass2: The bass sound is emphasized even more.</p> <p>Custom: You can design your own custom sound level for 5 bands of EQ (100 Hz, 300 Hz, 1 kHz, 3 kHz and 10 kHz) in 7 steps (-3 to +3).</p> <p>OFF*: The effect function does not work.</p>	48
		<p>Note</p> <p>When playing back files using the built-in speaker or when the noise cut function is effective (page 46), the effect function does not work.</p>	

Tabs	Menu items	Settings (*: Initial setting)	See page
▶ (Playback)	Easy Search	<p>Sets the easy search function.</p> <p>ON: You can go forward for about 10 seconds by pressing ▶▶ on the control button and go back for about 3 seconds by pressing ◀◀ on the control button. This function is useful when attempting to locate desired point in a long recording.</p> <p>OFF*: The easy search function does not work. When you press ▶▶ or ◀◀ on the control button, a file will be moved forward or backward.</p>	45
	Play Mode	<p>Sets the playback mode.</p> <p>1: A file is played back.</p> <p>*: Files in one folder are played back continuously.</p> <p>ALL: All the files are played back continuously.</p> <p>↶ 1: One file is played back repeatedly.</p> <p>↶ : Files in one folder are played back repeatedly.</p> <p>↶ ALL: All the files are played back repeatedly.</p>	50



Tabs	Menu items	Settings (*: Initial setting)	See page
 (Playback)	Alarm	<p>Sets the alarm.</p> <p>ON:</p> <p>The alarm function is effective. Set the date, time or day of the week or choose daily for playback, and set the following alarm pattern.</p> <p> Beep&Play: The selected file is played back after the alarm sounds.</p> <p> Beep: Only the alarm sounds.</p> <p> Play: Only the selected file is played back.</p> <p>OFF*:</p> <p>The alarm function is canceled.</p>	52
 (Edit)	Protect	<p>Protects the selected file to prevent the file from being erased, divided, or being moved.</p> <p>Execute:</p> <p>The selected file will be protected. If you specify a file that has already been protected, cancel the protection.</p> <p>Cancel:</p> <p>Protection or cancel protection is not executed.</p>	65
	Divide Current Position	<p>Divides a file into two.</p> <p>Execute:</p> <p>A file will be divided into two.</p> <p>Cancel:</p> <p>Division is not executed.</p>	62
	Move File	<p>Moves the selected file to the selected folder.</p> <p>Before attempting to move a file, select the file to be moved, and then go to the menu window.</p>	55
	File Copy	<p>Copies the selected file from the built-in memory to the desired folder on a memory card, or from a memory card to the desired folder on the built-in memory.</p> <p>Before attempting to copy a file, select the file to be copied and then go to the menu window.</p>	56

Tabs	Menu items	Settings (*: Initial setting)	See page
 (Edit)	Erase Track Mark	Erases the track mark just before the current position. Execute: The track mark will be erased. Cancel: The track mark will not be erased.	60
	Erase All Track Marks	Erases all the track marks of the selected file. Execute: All the track marks will be erased. Cancel: All the track marks will not be erased.	61
	Divide All Track Marks	Divides a file at all the track mark positions. Execute: The track mark division is executed. Cancel: The track mark division is not executed.	63
	Erase All	Erases all files in the selected folder. Press  to return to the folder window before erasing the files and select a folder from which all files are to be erased, and then go to the menu window. Execute: All files in the selected folder will be erased. Cancel: All files will not be erased.	57
 (Display)	Display	Changes the display mode. Elapsed Time*: Elapsed playback time of one file Remain Time: During stop or playback, the remaining time of one file During recording, the available recording time REC Date: Date recorded REC Time: Time recorded	-

Tabs	Menu items	Settings (*: Initial setting)	See page
 (Display)	LED	<p>Turns the operation indicator on or off during operation.</p> <p>ON*: During recording or playback, the operation indicator lights or flashes.</p> <p>OFF: The operation indicator does not light or flash, even during operation.</p> <p>Note When the IC recorder is connected to a computer, the operation indicator lights or flashes even if “LED” is set to “OFF.”</p>	–
	Backlight	<p>Turns the backlight in the display window on or off.</p> <p>ON*: The backlight in the display window lights up for approx. 10 seconds.</p> <p>OFF: The backlight in the display window does not light, even during operation.</p>	–
 (IC recorder setting)	Select Memory	<p>Selects the memory media on which you want to store a file, or which contains the file you want to play, edit, or copy.</p> <p>Built-In Memory*: The built-in memory of the IC recorder is selected.</p> <p>Memory Card: The memory card inserted in the memory card slot is selected.</p> <p>Note When no memory card is currently inserted in the IC recorder, the built-in memory is automatically selected.</p>	38

Tabs	Menu items	Settings (*: Initial setting)	See page
 (IC recorder setting)	Language	Sets the language to be used for messages, menus, folder names, file names, etc. English*, Español (Spanish), Français (French)	18
	Date&Time	Auto*: When the IC recorder is connected to a computer that is running the Sound Organizer, the clock will be automatically adjusted according to that computer. Manual: Sets the clock by setting year, month, day, hour, and minute in sequence.	15
	Time Display	Sets the clock display. 12-Hour*: 12:00AM = midnight, 12:00PM = noon 24-Hour: 0:00 = midnight, 12:00 = noon	–
	Beep	Sets whether a beep will be heard or not. ON*: A beep will sound to indicate that an operation has been accepted or an error has occurred. OFF: No beep sound will be heard. Note The alarm sounds even if you set “Beep” to “OFF” in the menu.	–

Tabs	Menu items	Settings (*: Initial setting)	See page
 (IC recorder setting)	USB Charge	Sets whether battery will be charged using a USB connection or not. ON*: The battery will be charged. OFF: The battery will not be charged.	–
<p>Note</p> <p>If you use a USB AC adaptor (not supplied) to connect the IC recorder to the AC outlet (page 95), you can charge battery regardless this setting.</p>			
	Auto Power Off	If the IC recorder is on and left for the period you have set, the IC recorder turns off automatically. 5min: The IC recorder will be turned off after approx. 5 minutes. 10min*: The IC recorder will be turned off after approx. 10 minutes. 30min: The IC recorder will be turned off after approx. 30 minutes. 60min: The IC recorder will be turned off after approx. 60 minutes. OFF: The IC recorder will not be turned off automatically.	–

Tabs	Menu items	Settings (*: Initial setting)	See page
 (IC recorder setting)	Format	Formats the memory media currently selected (the built-in memory or the memory card), erasing all the data in the memory and resetting the folder structure to its default status. Execute: The “Formatting...” animation appears and the memory media will be formatted. Cancel: The memory media will not be formatted.	–
 Notes			
<ul style="list-style-type: none"> • Use the IC recorder formatting function to format the memory media. • Switch the memory media to the one to be formatted before you start the format operation (page 38). • When you format the memory media, all the data which you have stored on the IC recorder will be erased. Once the memory media has been erased, you cannot retrieve the data that was erased. 			

Using the IC Recorder with Your Computer

When the IC recorder is connected to your computer, you can transfer data between them.

Copying files from the IC recorder to your computer to store them (page 86)

Copying music files from your computer to the IC recorder to play them back (page 87)

Using the IC recorder as USB memory (page 89)

You can store image data or text data stored on the computer temporarily in the IC recorder.

Managing and editing files using the Sound Organizer software (page 90)

The supplied Sound Organizer software allows you to transfer the files that you have recorded using the IC recorder to your computer to manage and edit them. You can also transfer music files and podcast files stored on your computer to the IC recorder.

System requirements for your computer

For details on the system requirements for your computer, see page 91, 100.

Connecting the IC recorder to your computer

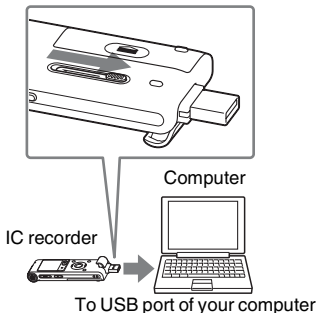

To exchange files between the IC recorder and your computer, connect the IC recorder to your computer.

- 1 Slide the USB slide lever on the back of the IC recorder, and insert the USB

DIRECT connector into the USB port of a running computer.

- 2** Make sure the IC recorder has been recognized properly.

On the Windows screen; open “My Computer” or “Computer;” and make sure that “IC RECORDER” or “MEMORY CARD” has been recognized.

On the Macintosh screen; make sure that an “IC RECORDER” or “MEMORY CARD” drive is displayed on the desktop.

The IC recorder is recognized by the computer as soon as the connection is made. While the IC recorder is connected to the computer, “Connecting” is displayed in the display window of the IC recorder.

If the IC recorder cannot be connected to a computer directly, use the supplied USB connection support cable.

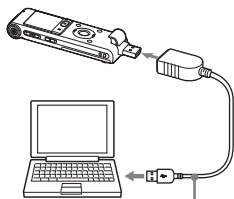

USB connection support cable
(supplied)

Notes

- If you connect more than two USB devices to your computer, normal operation will not be guaranteed.
- Use of this IC recorder with a USB hub or a USB cable other than the supplied USB connection support cable is not guaranteed.
- A malfunction may occur depending on the USB devices connected at the same time.
- Before connecting the IC recorder to your computer, check that the battery is inserted in the IC recorder.
- It is recommended that you disconnect the IC recorder from the computer when you are not using the IC recorder connected to the computer.

Structure of folders and files

The folders and files are displayed on the computer screen as shown.

On a Windows screen using Explorer, and on a Macintosh screen using Finder, folders and files can be displayed by opening “IC RECORDER” or “MEMORY CARD.”

Built-in memory

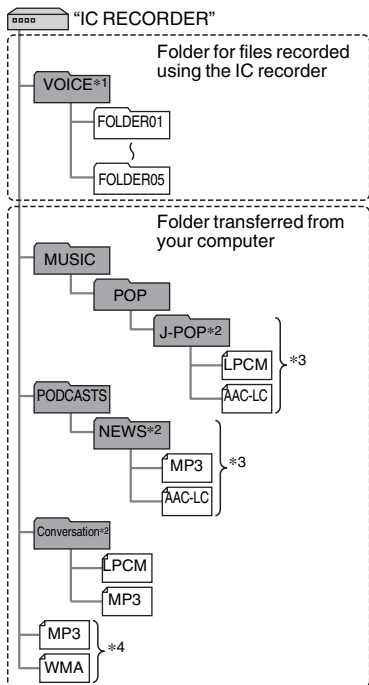

*1 Even if a file is transferred directly under the VOICE folder, it will not be displayed on the  (Voice) tab of the IC recorder.

When you transfer a file from your computer to the IC recorder, put the file in the folders under the VOICE folder.

*2 The name of a folder in which music files are stored will be displayed on the IC recorder as it is, so it is convenient if you put an easy-to-remember name on the folder in advance.

Folders shown in the illustration are examples of folder names.

*3 The IC recorder can recognize up to 8 levels of folders transferred to the IC recorder.

*4 If you transfer music files separately, they are classified as being in "No Folder."

Tips

- The title or artist name, etc., registered in the music files, can be displayed on the IC recorder. It is useful if you input the ID3 tag information using the software you use to make the music files on your computer.
- If no title, or artist name has been registered "Unknown" will be displayed in the display window of the IC recorder.

When connecting the IC recorder with your computer after the destination memory media has been set to "Memory Card" (page 38), the structure of folders is different from that when the destination memory media is set to "Built-In Memory."

Memory Stick Micro™ (M2™)

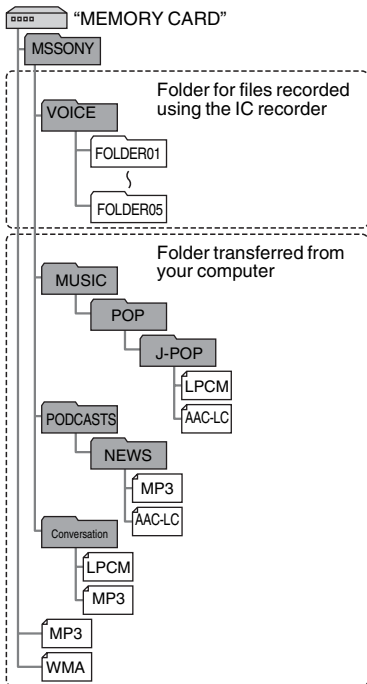

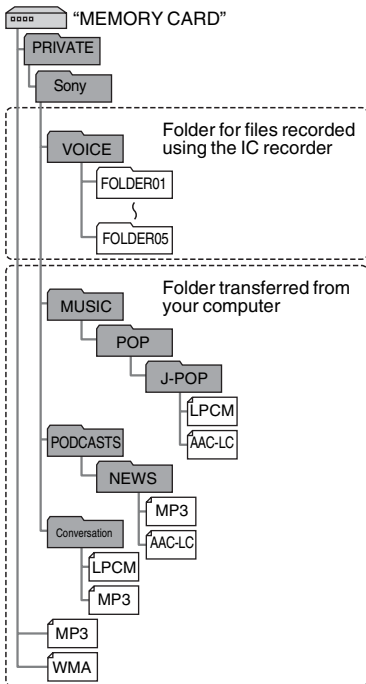

microSD card



Structure of folders displayed in the display window of the IC recorder

The display of the structure of the folders seen in the display window of the IC recorder is different from that seen on the display of a computer.

The folder indicators in the display window of the IC recorder are as follows:

- : Folder for files recorded using the IC recorder
- : Folder transferred from a computer (They are displayed when music files have been transferred from a computer.)
- : Folder for podcast files transferred from a computer (These folders are displayed when podcast files have been transferred from a computer.)

Note

If folders have no files that can be played back using the IC recorder, those folders will not be displayed in the display window of the IC recorder.

Folders displayed on the (Voice) tab of the IC recorder



Folders for files recorded using the IC recorder (folders under the VOICE folder) will be displayed.

Note

Even if a file is transferred directly under the VOICE folder, it will not be displayed on the (Voice) tab of the IC recorder.

Folders displayed on the (Music) tab of the IC recorder



The following folders will be displayed among the folders forwarded from a computer.

- Folders under the MUSIC folder which contains a file (when some folders have multiple levels, all folders will be displayed in parallel.)

- Folders transferred to places other than under the MUSIC folder or the PODCASTS folder
- A folder called “No Folder” (If you transfer music files separately, those files will be displayed under this folder.)

Folders displayed on the (Podcast) tab of the IC recorder



Folders for podcast files transferred from a computer will be displayed.

When you transfer podcast files from your computer to the IC recorder, use the supplied Sound Organizer software.

Disconnecting the IC recorder from your computer

Follow the procedures below; otherwise, data may be damaged.

- 1 Make sure that the operation indicator of the IC recorder does not light.

- 2 Perform the following operation on your computer.

On a Windows screen, left-click the icon at the bottom of the desktop of the computer.



→ Left-click “Eject IC RECORDER.”

The icon and menu displayed can be different on different operating systems. On a Macintosh screen, drag “IC RECORDER” on the desktop to “Trash” and drop it there.

For details on disconnecting the IC recorder from your computer, refer to the operating instructions supplied with your computer.

- 3 Disconnect the IC recorder from the USB port of the computer, and slide the USB slide lever in the direction of the arrow to retract the USB DIRECT connector.

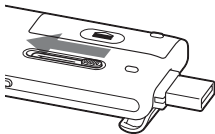

Copying Files from the IC Recorder to Your Computer

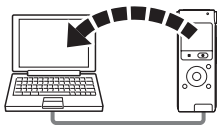

You can copy the files and folders from the IC recorder to your computer to store them.

- 1** Connect the IC recorder to your computer (page 80).
- 2** Copy files or folders you want to transfer to your computer.
Drag and drop the files or folders you want to copy from “IC RECORDER” or “MEMORY CARD” to the local disk on your computer.

 **To copy a file or folder (Drag and drop)**

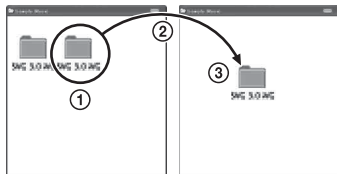

- 1** Click and hold,
- 2** drag,
- 3** and then drop.

- 3** Disconnect the IC recorder from your computer (page 85).

Copying Music Files from Your Computer to the IC Recorder and Playing Them Back



You can copy music or the other audio files (LPCM(.wav)/MP3(.mp3)/WMA(.wma)/AAC-LC(.m4a)*) from your computer to the IC recorder by dragging and dropping them, and you can play them back using the IC recorder.

* For the file formats that can be played back using the IC recorder, see “Specifications” (page 100).

Copying a music file from your computer to the IC recorder (drag and drop)

- 1 Connect the IC recorder to your computer (page 80).







- 2 Copy the folder in which the music files are stored to the IC recorder.

On a Windows screen using Explorer, or on a Macintosh screen using Finder, drag and drop the folder containing the music files onto “IC RECORDER” or “MEMORY CARD.”

The IC recorder can recognize up to 400 folders. You can copy up to 199 files to one folder. Moreover, the IC recorder can recognize up to a total of 4,095 folders and files for one memory media.

- 3 Disconnect the IC recorder from your computer (page 85).

Playing back music files copied from your computer using the IC recorder

- 1 Press .
- 2 Press  on the control button, press  or  on the control button to select the  (Music) tab, and then press .

- 3 Press ▲ or ▼ on the control button to select the folder (📁) in which music files are stored, and then press ▶▶ on the control button.
- 4 Press ▲ or ▼ on the control button to select the music file you want to play.
- 5 Press ▶/ENT to start playback.
- 6 Press ■ STOP to stop playback.

The maximum playback time (files*), when playing music files using the IC recorder, is as follows.

48 kbps	128 kbps	256 kbps
89 hr. 25 min. (1,341 files)	33 hr. 30 min. (502 files)	16 hr. 45 min. (251 files)

(hr.: hours/min.: minutes)

* In the case where MP3 files of 4 minutes each are transferred to the IC recorder.

■ Notes

- A music file copied from your computer can be played back with the IC recorder. Dividing a file and setting a track mark, however, may not be performed.
- If you have copied music files using your computer, those files may not be copied in order of transfer because of system

limitations. If you copy music files from your computer to the IC recorder one by one, you can display and play back the music files in copied order.

Display when playing back a music file

Press ▲ or ▼ on the control button to check the music file information during playback.

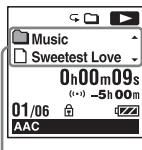

📁 : Folder name

📄 : File name

👤 : Artist name

🎵 : Title

Using the IC Recorder as USB Memory

When the IC recorder is connected to your computer, image data or text data on the computer, as well as files recorded using the IC recorder can be temporarily stored on the IC recorder.

Your computer must meet the specified system requirements to use the IC recorder as USB memory.

For details on the system requirements, see page 100.

Using the Supplied Sound Organizer Software

What you can do using Sound Organizer

Sound Organizer allows you to exchange files with an IC recorder or memory card. The songs imported from music CDs and other media, MP3 and other audio files imported from a computer, and podcasts can also be played and transferred to an IC recorder. Various operations can be performed for imported files, including playback, editing and conversion to MP3 and other formats. You can also burn CDs of the music you like, and send audio files by mail.

Importing files recorded with an IC recorder

You can import recording files that were recorded with an IC recorder into Sound Organizer. The imported files are saved to the computer.

Importing songs from a music CD

You can import the songs of a music CD into Sound Organizer.

The imported songs are saved to the computer.

Importing songs on the computer

You can import music and other files saved to the computer into Sound Organizer.

Subscribing to and updating podcasts

You can subscribe to podcasts in Sound Organizer. Subscribing to and updating podcasts enables you to download (subscription) and enjoy the latest data from the Internet.

Playing files

You can play the files imported into Sound Organizer.

Changing the file information of files

You can change the title name, artist name, and other file information displayed in the file list.

Dividing files

You can divide one file into multiple files.

Combining files

You can combine multiple files into one file.

Deleting files from an IC recorder

You can delete a file saved to an IC recorder. Use this operation to delete files in the IC recorder when you want to increase the amount of free space in the IC recorder or there are unnecessary files.

Transferring files to an IC recorder

You can transfer a file from Sound Organizer to an IC recorder or memory card. You can enjoy transferred music, podcasts, and other content on your IC recorder.

Burning a music CD

You can select your favorite songs from the songs imported into Sound Organizer and then burn your own original music CD.

Other convenient uses

- You can start the mail software and send a recording file attached to mail.
- You can use the voice recognition software Dragon NaturallySpeaking (not supplied) which is compatible with Sound Organizer to perform voice recognition for a file and convert the voice to text.

System requirements for your computer

The following shows the system requirements for using Sound Organizer.

Operating systems

- Windows 7 Ultimate
 - Windows 7 Professional
 - Windows 7 Home Premium
 - Windows 7 Starter (32 bit version)
 - Windows Vista Ultimate Service Pack 2 or higher
 - Windows Vista Business Service Pack 2 or higher
 - Windows Vista Home Premium Service Pack 2 or higher
 - Windows Vista Home Basic Service Pack 2 or higher
 - Windows XP Media Center Edition 2005 Service Pack 3 or higher
 - Windows XP Media Center Edition 2004 Service Pack 3 or higher
 - Windows XP Professional Service Pack 3 or higher
 - Windows XP Home Edition Service Pack 3 or higher
- Pre-installed.

■ Notes

- Operation is not guaranteed if any operating system other than those indicated listed above is used.
- 64 bit versions of Windows XP are not supported.

IBM PC/AT or compatible

- CPU
Windows XP: Pentium III processor of 500 MHz or faster
Windows Vista: Pentium III processor of 800 MHz or faster
Windows 7: Pentium III processor of 1 GHz or faster
- Memory
Windows XP: At least 256 MB
Windows Vista: At least 512 MB (In the case of Windows Vista Ultimate/Business/Home Premium, at least 1 GB is recommended.)
Windows 7: At least 1 GB (32 bit version)/At least 2 GB (64 bit version)
- Free hard disk space
At least 400 MB is required.
Depending on the version of Windows, more than 400 MB may be used.
Also, free space for handling music data is required.

- Display settings
Screen resolution: 800 × 600 pixels or higher (1,024 × 768 pixels is recommended)
Screen color: High Color (16 bit) or higher
- Sound card
A SoundBlaster compatible card is recommended.
- USB port
A compatible USB port is required to use devices and media.
Operation via a USB hub is not guaranteed except for models for which operation has been specifically guaranteed.

Installing Sound Organizer

Install Sound Organizer on your computer.

■ Notes

- When installing Sound Organizer, log in to an account with administrator privileges. Also, if you are using Windows 7 and the [User Account Control] screen appears, confirm the contents of the screen and then click [Yes] ([Continue] in the case of Windows Vista).
- Sound Organizer cannot be started by a user with limited privileges in Windows XP.

- To use the software update function in Windows XP, you must log on to an account with computer administrator privileges.
- The Windows Media Format Runtime module is added by the installer of Sound Organizer. This module is not removed when Sound Organizer is uninstalled. However, it may not be installed if it has been preinstalled.
- The data in the content storage folders is not deleted when Sound Organizer is uninstalled.
- In an installation environment in which multiple operating systems are installed on one computer, do not install Sound Organizer in each of the operating systems. Doing so may result in data inconsistencies.

1 Make sure that the IC recorder is not connected, then turn on your computer and start up Windows.

2 Insert the supplied CD-ROM into the CD-ROM drive.

The [Sound Organizer - InstallShield Wizard] menu starts up automatically and the [Welcome to Sound Organizer Installer] window appears.

If the [Welcome to Sound Organizer Installer] menu does not start up, open Windows Explorer, right-click the CD-ROM drive, double-click

[SoundOrganizerInstaller.exe], and then follow the instructions on the screen.

3 Make sure that you accept the terms of the license agreement, select [I accept the terms in the license agreement], then click [Next].

4 When the [Setup Type] window appears, select [Standard] or [Custom], and then click [Next].

Follow the instructions on the screen and set the installation settings when you select [Custom].

5 When the [Ready to Install the Program] window appears, click [Install]. The installation starts.

6 When [Sound Organizer has been installed successfully.] window appears, check [Launch Sound Organizer Now], and then click [Finish].

Note

You may need to restart your computer after installing Sound Organizer.

The Sound Organizer window

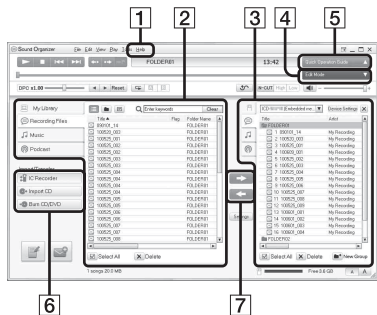

1 Help

Displays the help of Sound Organizer. For details on each operation, refer to these help files.

2 The file list of Sound Organizer (My Library)

Displays a list of files included in My Library of Sound Organizer in accordance with the operation.

 Recording Files : Displays a list of recording files.

Recording files that were recorded with an IC recorder appear in this library when they are imported.

 Music: Displays a list of music files. Songs imported from a music CD appear in this library.

 Podcast: Displays a list of podcasts.

3 The file list of the IC recorder

Displays the files saved to the connected IC recorder or memory card.

4 Edit Mode button

Displays the edit area so that you can edit a file.

5 Quick Operation Guide button

Displays the Quick Operation Guide to receive guidance on the basic features of Sound Organizer.

6 Sidebar (Import/Transfer)

 IC Recorder: Displays the transfer screen. A list of files on a connected device appears.

 Import CD: Displays the screen for importing music CDs.

 Burn CD/DVD: Displays the screen for burning discs.

7 Transfer buttons

 : Transfers the files of Sound Organizer to an IC recorder or memory card.

 : Imports the files of an IC recorder or memory card to My Library of Sound Organizer.

Using a USB AC Adaptor

USB connector of the IC recorder

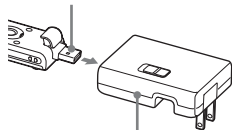

USB AC adaptor (not supplied)

You can charge the rechargeable battery by connecting the IC recorder to an AC outlet using a USB AC adaptor AC-U501AD (not supplied). You can charge the battery while you are using the IC recorder, so that it is useful when you want to record for a long time.

When you use the IC recorder for the first time, or after you have not used the IC recorder for a certain period of time, charge the battery continuously until “**FULL**” is displayed.

It takes about 3 hours 30 minutes to fully charge an exhausted battery.*

- 1 Connect a USB AC adaptor (not supplied) to an AC outlet.

- 2 Slide the USB slide lever on the back of the IC recorder and connect the USB DIRECT connector to the USB AC adaptor.

While the battery is charging, the battery indicator is displayed in an animation.

Now you can use the IC recorder while charging the battery.

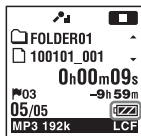

Battery indicator

- * This is an approximation for the time it takes to charge from no remaining battery power to full battery power at room temperature. It varies depending on the remaining power and the condition of the battery. It also takes more time if the temperature of the battery is low, or if the battery is charged while you are transferring data to the IC recorder.

Notes

- While playing back files using the built-in speaker, you cannot charge the battery.
- You cannot charge an LR03 (size AAA) alkaline battery (not supplied).

Disconnecting the IC recorder from the AC outlet

Follow the procedures below; otherwise, when the IC recorder contains data files, the files may be damaged or become unplayable.

- 1 If you are recording or playing back a file, press ■ STOP to put the IC recorder into the stop mode.
- 2 Make sure that the operation indicator of the IC recorder does not light.
- 3 Disconnect the IC recorder from the USB AC adaptor, and then disconnect the USB AC adaptor from the AC outlet.

■ Notes

- During recording (the operation indicator lights or flashes in red) or accessing data (the operation indicator flashes in orange),
 - the IC recorder should not be connected to or disconnected from the USB AC adaptor connected to the AC outlet.
 - the USB AC adaptor connected to the IC recorder should not be connected to or disconnected from the AC outlet.
- Doing so may damage the data. If the IC recorder is required to process a large amount of data, the start-up window may be

displayed for an extended period of time. This is not a malfunction of the IC recorder. Wait until the start-up display disappears from the display window.

- While a USB AC adaptor is being used, the battery indicator does not appear in the display window.

Precautions

On power

Operate the unit only on 1.2 V or 1.5 V DC. Use one NH-AAA rechargeable battery or one LR03 (size AAA) alkaline battery.

On safety

Do not operate the unit while driving, cycling or operating any motorized vehicle.

On handling

- Do not leave the unit in a location near heat sources, or in a place subject to direct sunlight, excessive dust or mechanical shock.
- Should any solid object or liquid fall into the unit, remove the battery and have the unit checked by qualified personnel before operating it any further.
- Be careful not to allow water to splash on the unit. The unit is not water-proof. In particular, be careful in the following situations.
 - When you have the unit in your pocket and go to the bathroom, etc.
When you bend down, the unit may drop into the water and may get wet.
 - When you use the unit in an environment where the unit is exposed to rain, snow, or humidity.

– In circumstances where you get sweaty.

If you touch the unit with wet hands or if you put the unit in the pocket of sweaty clothes, the unit may get wet.

- You may feel pain in your ears if you use the headphones when the ambient air is very dry. This is not because of a malfunction of the headphones, but because of static electricity accumulated in your body. You can reduce static electricity by wearing non-synthetic clothes that prevent the emergence of static electricity.

On noise

- Noise may be heard when the unit is placed near an AC power source, a fluorescent lamp or a mobile phone during recording or playback.
- Noise may be recorded when an object, such as your finger, etc., rubs or scratches the unit during recording.

On maintenance

To clean the exterior, use a soft cloth slightly moistened in water. Then use a soft dry cloth to wipe the exterior. Do not use alcohol, benzine or thinner.

If you have any questions or problems concerning your unit, please consult your nearest Sony dealer.

Backup recommendations

To avoid potential risk of data loss caused by accidental operation or malfunction of the IC recorder, we recommend that you save a backup copy of your recorded files to a computer, etc.

On using a memory card

■ Notes

- When formatting (initializing) a memory card, make sure to use the IC recorder to format it. Operations of the memory cards formatted with Windows or other devices are not guaranteed.
- If you format a memory card containing recorded data, the recorded data will be deleted. Be careful not to delete important data.
- Do not leave a memory card within the reach of small children. They might accidentally swallow it.
- Do not insert or remove a memory card during recording/playback/formatting. Doing so may cause a malfunction of the IC recorder.
- Do not remove a memory card while the “Accessing...” animation appears in the display window or the indicator is flashing in orange. Doing so may damage the data.
- We do not guarantee the operations of all types of compatible memory cards with the IC recorder.
- For compatible M2™, please refer to the Sony web site (page 101).
- “MagicGate™” is the collective name of content protection technologies developed by Sony. The IC recorder does not support data recording/playback that requires MagicGate™ functions.
- The IC recorder does not support parallel data transfer.
- You cannot use a ROM (read-only-memory) type or write-protected memory card.
- Data may be corrupted in the following cases:
 - When a memory card is removed or the IC recorder is turned off during a read or write operation.
 - When a memory card is used in locations subject to static electricity or electrical noise.
- We assume no responsibility for any loss or damage of recorded data.
- We recommend that you save a backup copy of the important data.
- Do not touch the terminal of a memory card with your hand or a metal object.
- Do not strike, bend or drop a memory card.
- Do not disassemble or modify a memory card.
- Do not expose a memory card to water.

- Do not use a memory card under the following conditions:
 - Locations beyond the required operating conditions, including locations, such as the hot interior of a car parked in the sun and/ or in the summer, the outdoors exposed to direct sunlight, or a place near a heater.
 - Humid locations or locations with corrosive substances present.
- When using a memory card, make sure to check the correct insertion direction into the memory card slot.

Specifications

System requirements

To use your computer with the Sound Organizer software

To use your computer with the Sound Organizer software, see “System requirements for your computer” on page 91.

To use your computer without the Sound Organizer software

To use your computer with the IC recorder without the Sound Organizer software, or to use the IC recorder as a USB mass storage device, your computer must meet the operating system requirements and port environment described below.

Operating systems:

- Windows 7 Ultimate
- Windows 7 Professional
- Windows 7 Home Premium
- Windows 7 Home Basic
- Windows 7 Starter
- Windows Vista Ultimate Service Pack 2 or higher
- Windows Vista Business Service Pack 2 or higher

- Windows Vista Home Premium Service Pack 2 or higher
 - Windows Vista Home Basic Service Pack 2 or higher
 - Windows XP Media Center Edition 2005 Service Pack 3 or higher
 - Windows XP Media Center Edition 2004 Service Pack 3 or higher
 - Windows XP Media Center Edition Service Pack 3 or higher
 - Windows XP Professional Service Pack 3 or higher
 - Windows XP Home Edition Service Pack 3 or higher
 - Mac OS X (v10.2.8-v10.6)
- Pre-Installed

■ Notes

- Operation is not guaranteed if any operating system other than those indicated on the left (Windows 98, Windows 2000 or Linux, etc.) is used.
- 64 bit versions of Windows XP are not supported.

- For the latest version information and compatibility with your operating system, please access the support home page for the IC recorder:
<http://www.sony.com/recordersupport>

Hardware environment:

- Sound board: Sound cards compatible with any of the supported Microsoft Windows operating systems
- Port: USB port

Note

- The following systems are not supported:
 - Operating systems other than the ones indicated on page 100
 - Personally constructed computers or operating systems
 - Upgraded operating systems
 - Multi-boot environment
 - Multi-monitor environment

Design and specifications

IC recorder section

Capacity (User available capacity)

2 GB equals 2,147,483,648 bytes, a portion of which is used for system management and/or application files.

Available capacity is approximately 1.80 GB (1,932,735,283 bytes).

Frequency range

- LPCM 44.1kHz/16bit: 50 Hz - 20,000 Hz
- MP3 192kbps: 50 Hz - 20,000 Hz
- MP3 128kbps: 50 Hz - 16,000 Hz
- MP3 48kbps(MONO): 50 Hz - 14,000 Hz
- MP3 8kbps(MONO): 60 Hz - 3,400 Hz

Bit rate and sampling frequencies for MP3 files*1

Bit rate: 32 kbps - 320 kbps, VBR

Sampling frequencies:

16/22.05/24/32/44.1/48 kHz

File extension: .mp3

*1 The playback of MP3 files recorded using the IC recorder is also supported. Not all encoders are supported.

Bit rate and sampling frequencies for WMA files*2

Bit rate: 32 kbps - 192 kbps, VBR

Sampling frequencies: 44.1 kHz

File extension: .wma

*2 WMA Ver. 9 is compatible, however, MBR (Multi Bit Rate), Lossless, Professional, and Voice are not supported. Copyright-protected file cannot be played back. Not all encoders are supported.

Bit rate and sampling frequencies for AAC-LC files*3

Bit rate: 16 kbps - 320 kbps, VBR

Sampling frequencies:

11.025/12/16/22.05/24/32/44.1/48 kHz

File extension: .m4a

*3 Copyright-protected file cannot be played back. Not all AAC encoders are supported.

Sampling frequencies and bit for linear PCM files

Sampling frequencies: 44.1 kHz
Bit: 16 bit
File extension: .wav

General

Speaker

Approx. 16 mm (21/32 in.) dia.

Input/Output

- Microphone jack (minijack, stereo)
 - input for plug in power, minimum input level
 - 0.9 mV
- Headphone jack (minijack, stereo)
 - output for 8 ohms - 300 ohms impedance headphones
- USB connector (Type-A)
 - High-Speed USB compatible
- Memory Stick Micro™ (M2™)/microSD memory card slot

Playback speed control (DPC)

2.00 times - 0.50 times (MP3)
1.00 time - 0.50 times (LPCM/WMA/AAC-LC)

Power output

90 mW

Power requirements

One NH-AAA rechargeable battery (supplied):
1.2 V DC

One LR03 (size AAA) alkaline battery (not supplied): 1.5 V DC

Operating temperature

5°C - 35°C (41°F - 95°F)

Dimensions (w/h/d) (not incl. projecting parts and controls) (JEITA)*4

Approx. 36.6 mm × 102.0 mm × 14.6 mm
(1 1/2 in. × 4 1/8 in. × 19/32 in.)

Mass (JEITA)*4

Approx. 59 g (2 1/8 oz) including one NH-AAA rechargeable battery

*4 Measured value by the standard of JEITA (Japan Electronics and Information Technology Industries Association)

Supplied accessories

See page 8.







Optional accessories

Memory Stick Micro™ (M2™) MS-A16GU2, MS-A8GU2, MS-A4GU2, MS-A2GU2
microSD/microSDHC SR-8A4, SR-4A4, SR-2A1
Active speaker SRS-M50
Electret condenser microphone ECM-CS10, ECM-CZ10, ECM-TL1
Audio connecting cable RK-G136, RK-G139
Rechargeable battery NH-AAA-B2KN
USB AC adaptor AC-U501AD

Design and specifications are subject to change without notice.

Maximum recording time*5*6

The maximum recording time of all the folders is as follows.

REC Mode	Recording scene*7	Built-in memory	Memory card				
		ICD-UX512	2 GB	4 GB	8 GB	16 GB	32 GB
LPCM 44.1kHz/ 16bit		3 hr. 0 min.	3 hr. 0 min.	6 hr. 0 min.	12 hr. 5 min.	24 hr. 15 min.	48 hr. 40 min.
MP3 192kbps	 (Meeting)  (Interview)  (Lecture)  (Audio IN)  (My Scene)	22 hr. 20 min.	22 hr. 20 min.	44 hr. 40 min.	89 hr. 25 min.	178 hr. 0 min.	357 hr. 0 min.
MP3 128kbps	 (Voice Notes)	33hr. 30 min.	33 hr. 30 min.	67 hr. 5 min.	134 hr. 0 min.	268 hr. 0 min.	536 hr. 0 min.
MP3 48kbps (MONO)		89 hr. 25 min.	89 hr. 25 min.	178 hr. 0 min.	357 hr. 0 min.	715 hr. 0 min.	1,431 hr. 0 min.
MP3 8kbps (MONO)		536 hr. 0 min.	536 hr. 0 min.	1,073 hr. 0 min.	2,147 hr. 0 min.	4,294 hr. 0 min.	8,589 hr. 0 min.

(hr.: hours/min.: minutes)

*5 When you are going to record continuously for a long time, you may have to replace the battery with new one in the midst of recording. For details on the battery life, see the next table.

*6 The maximum recording time varies if you record files in mixed recording mode.

*7 Default settings

Battery life

When using a Sony NH-AAA rechargeable battery*1

REC Mode	Recording	Playback through speaker*2	Playback using the headphones
LPCM 44.1kHz/16bit	21 hr. 0 min.	16 hr. 0 min.	34 hr. 0 min.
MP3 192kbps	23 hr. 0 min.	17 hr. 0 min.	41 hr. 0 min.
MP3 128kbps	23 hr. 0 min.	17 hr. 0 min.	41 hr. 0 min.
MP3 48kbps(MONO)	24 hr. 0 min.	17 hr. 0 min.	41 hr. 0 min.
MP3 8kbps(MONO)	29 hr. 0 min.	17 hr. 0 min.	41 hr. 0 min.
Music file (128 kbps/44.1kHz)	–	17 hr. 0 min.	41 hr. 0 min.

(hr.: hours/min.: minutes)

When using a Sony LR03 (SG) (size AAA) alkaline battery*1

REC Mode	Recording	Playback through speaker*2	Playback using the headphones
LPCM 44.1kHz/16bit	22 hr. 0 min.	21 hr. 30 min.	49 hr. 0 min.
MP3 192kbps	27 hr. 0 min.	23 hr. 0 min.	61 hr. 0 min.
MP3 128kbps	30 hr. 30 min.	23 hr. 0 min.	61 hr. 0 min.
MP3 48kbps(MONO)	32 hr. 30 min.	23 hr. 0 min.	61 hr. 0 min.
MP3 8kbps(MONO)	42 hr. 0 min.	23 hr. 0 min.	61 hr. 0 min.
Music file (128 kbps/44.1kHz)	–	23 hr. 0 min.	61 hr. 0 min.

(hr.: hours/min.: minutes)

*1 The battery life is measured in testing using methods proprietary to Sony. The battery life may shorten depending on how you operate the IC recorder.

*2 When playing back music through the internal speaker with the volume level set to 14

Troubleshooting









Before taking the IC recorder for repair, check the following sections. Should any problem persist after you have made these checks, consult your nearest Sony dealer.

Please note that recorded files may be deleted during service or repair work.

Symptom	Remedy
Noise is heard.	<ul style="list-style-type: none">• An object, such as your finger, etc., accidentally rubbed or scratched the IC recorder during recording so that noise was recorded.• The IC recorder was placed near an AC power source, a fluorescent lamp or a mobile phone during recording or playback.• The plug of the connected microphone is dirty. Clean the plug.• The plug of the connected headphones is dirty. Clean the plug.• Noise may be heard during recording pause of an MP3 file, VOR recording, or synchronized recording.• When you are listening an AAC-LC and WMA file, the noise cut function does not work.
You cannot charge the battery by connecting the IC recorder to your computer.	<ul style="list-style-type: none">• When you connect the IC recorder to a computer which is not running, the battery will not be charged.• Even if the computer is on, and the computer is in a mode of reduced operation (standby or sleep), you cannot charge the battery.• “USB Charge” is set to “OFF” in the menu. To charge the battery using your computer, set it to “ON” (page 78).• Disconnect the IC recorder from your computer and reconnect it.• Operation is not guaranteed if you use any system requirements other than those described on page 100.

Symptom	Remedy
The charging indicator is not displayed or disappears in the middle of charging.	<ul style="list-style-type: none"> • A rechargeable battery has not been inserted, or a battery other than a rechargeable battery (alkaline battery, manganese battery, etc.) has been inserted. • A rechargeable battery has been inserted with incorrect polarity. • A rechargeable battery other than NH-AAA has been inserted. • The rechargeable battery has deteriorated. Replace the old rechargeable battery with a new one. • The USB DIRECT connector of the IC recorder is not connected properly. • “USB Charge” is set to “OFF” in the menu. To charge the battery using your computer, set it to “ON” (page 78). • While playing back files using the built-in speaker, you cannot charge the battery.
The IC recorder cannot be turned off.	<ul style="list-style-type: none"> • Slide the HOLD/POWER switch in the direction of “POWER” for more than 2 seconds when the IC recorder is stopped (page 14).
The IC recorder cannot be turned on.	<ul style="list-style-type: none"> • The power to the IC recorder is off. Slide the HOLD/POWER switch in the direction of “POWER” for more than 1 second (page 14). • The battery has been inserted with incorrect polarity (page 11).
The IC recorder is powered off automatically.	<ul style="list-style-type: none"> • When the IC recorder is in the stop mode and you leave the IC recorder without attempting an operation for a certain length of time, the auto power off function will take effect. (The length of time before auto power off is set to “10min” when you purchase the IC recorder.) You can select the length of time before auto power off takes effect in the menu (page 78).
The IC recorder does not operate correctly.	<ul style="list-style-type: none"> • Take out the battery and insert it again.
It takes a long time for the IC recorder to start.	<ul style="list-style-type: none"> • If the IC recorder is required to process a large amount of data, it may take longer for the IC recorder to start. This is not a malfunction of the IC recorder. Wait until the start-up display disappears.

Symptom	Remedy
The IC recorder does not operate.	<ul style="list-style-type: none">• You may have formatted the memory of the IC recorder using the computer. Use the IC recorder formatting function to format the memory (page 79).
The IC recorder does not operate, even if you press any button.	<ul style="list-style-type: none">• The battery is weak (page 13).• The power to the IC recorder is off. Slide the HOLD/POWER switch in the direction of “POWER” for more than 1 second (page 14).• The HOLD function is activated. Slide the HOLD/POWER switch in the center direction (page 10).
No sound comes from the speaker.	<ul style="list-style-type: none">• The volume is turned down completely (page 24).• Headphones are plugged in (page 45).
Sound comes from the speaker even when the headphones are plugged in.	<ul style="list-style-type: none">• If you plug in the headphones not securely during playback, the sound may come from the speaker. Unplug the headphones, and then insert them securely.
The operation indicator does not light.	<ul style="list-style-type: none">• “LED” is set to “OFF.” Display the menu and set “LED” to “ON” (page 76).
The “Memory Full” animation is displayed and you cannot start recording.	<ul style="list-style-type: none">• The memory is full. Erase some of the files (page 28) or erase all the files after you store them on the other memory media or on your computer.
The “File Full” animation is displayed and you cannot operate the IC recorder.	<ul style="list-style-type: none">• 199 files have been recorded in the selected folder (📁) or 4,074 files (when there are 21 folders) in total have been recorded. Therefore you cannot record another file, or move a file. Erase some of the files (page 28) or erase all the files after you store them on the other memory media or on your computer.
You cannot record a file.	<ul style="list-style-type: none">• The remaining memory capacity is insufficient.• You cannot record a file when you select a folder in the playback-only area (the 🎵 (Music) tab and the 🎧 (Podcast) tab).

Symptom	Remedy
The playback volume is low.	<ul style="list-style-type: none"> The volume is turned down completely. Press VOL+ or – to adjust the volume (page 24). The recording scene is set to  (Voice Notes) or  (Audio IN). Select a recording scene depending on the current situation (page 30). “Mic Sensitivity” is set to “Low . Set it to “High . or “Medium .
Recording is interrupted.	<ul style="list-style-type: none"> The VOR function is activated. Set “VOR” to “OFF” in the menu (page 35).
The VOR function does not work.	<ul style="list-style-type: none"> During synchronized recording, the VOR function does not work (page 42).
When recording from other equipment, the input level is too strong or not strong enough.	<ul style="list-style-type: none"> Connect the headphone jack of other equipment to the  (microphone) jack of the IC recorder and adjust the volume level on the piece of equipment connected to the IC recorder.
Playback speed is too fast or too slow.	<ul style="list-style-type: none"> The playback speed is adjusted in DPC. Slide the DPC(SPEED CTRL) switch to “OFF” or press  or  on the control button to adjust the speed in DPC (page 47).
You cannot divide a file.	<ul style="list-style-type: none"> You need a certain amount of free space in the memory to divide a file. 199 files have been recorded in the selected folder (). Erase some of the files (page 28) or erase all the files after you store them on the other memory media or on your computer. Because of the system limitations, you may not be able to divide a file at the very beginning or at the very end of the file. You cannot divide files other than those recorded using the IC recorder (e.g., a file transferred from a computer).

Symptom	Remedy
The memory card is not recognized.	<ul style="list-style-type: none">• Since the memory card may contain image data or other files, the memory required for creating initial folders is insufficient. Use Windows Explorer, Macintosh desktop, or other tools to erase unwanted files or initialize the memory card on the IC recorder.• Switch the memory media of the IC recorder to “Memory Card” (page 38).• Remove a memory card and check the side of the memory card. Then insert it with correct side and direction.
“--:--” is displayed.	<ul style="list-style-type: none">• You have not set the clock (page 15).
“--y--m--d” or “--:--” is displayed on the REC Date display.	<ul style="list-style-type: none">• The date of recording will not be displayed if you recorded the file when the clock was not set.
There are fewer menu items displayed in the menu mode.	<ul style="list-style-type: none">• The menu items displayed are different depending on the operation modes (stop mode, playback mode, or recording mode) (page 67).
The remaining time displayed in the display window is shorter than that displayed in the supplied Sound Organizer software.	<ul style="list-style-type: none">• The IC recorder requires a certain amount of memory for system operation. That amount is subtracted from the remaining time, which is the reason for the difference.
The battery life is short.	<ul style="list-style-type: none">• The battery life on page 104 is based on playback with the volume level set to 14. The battery life may shorten depending on the operation of the IC recorder.
There is no battery power remaining after you have left the battery inserted for long time without using the IC recorder.	<ul style="list-style-type: none">• Even if you do not use the IC recorder, the battery is consumed slightly. If you do not intend to use the IC recorder for an extended period of time, it is recommended that you turn the power off (page 14) or remove the battery. Moreover, if you set “Auto Power Off” to a short span in the menu (page 78), you can prevent the battery from being consumed due to forgetting to turn the IC recorder off.

Symptom	Remedy
There is no battery power remaining when you disconnect the IC recorder from the USB AC adaptor after you have left the IC recorder connected for long time, fully charged.	<ul style="list-style-type: none"> • Once the battery is fully charged, it is not recharged automatically, even if you leave the IC recorder connected to the USB AC adaptor. You can use the IC recorder while it is connected to the USB AC adaptor, but charge it again after disconnecting it.
“ COLD ” or “ HOT ” is flashing instead of the battery indicator.	<ul style="list-style-type: none"> • The environmental temperature is out of the range for charging. Charge the battery in an environment with a temperature of 5 °C - 35 °C (41 °F - 95 °F).
The battery life of the rechargeable battery is short.	<ul style="list-style-type: none"> • You are using the rechargeable battery in an environment with a temperature of under 5 °C (41 °F). Charge the battery in an environment with a temperature of 5 °C - 35 °C (41 °F - 95 °F). • The IC recorder has not been used for a certain time. Charge and discharge the rechargeable battery using the IC recorder several times. • Replace the old rechargeable battery with a new one. • The battery indicator is displayed only for a short time, however, the rechargeable battery is not charged completely. It takes about 3 hours 30 minutes to fully charge an exhausted battery.
Menu does not reflect the change in settings.	<ul style="list-style-type: none"> • If the battery is removed just after the menu setting is changed, or the menu setting is changed using “IC Recorder Setting” of the Sound Organizer software with the exhausted battery inserted, the menu setting may not function.
A character in a folder or file name is displayed in unreadable characters.	<ul style="list-style-type: none"> • The IC recorder cannot support or display some special characters and symbols that are entered on a computer using Windows Explorer or the Macintosh desktop.
The “Accessing...” animation display does not disappear.	<ul style="list-style-type: none"> • If the IC recorder is required to process excessive amount of data, the animation may be displayed for an extended period of time. This is not a malfunction of the IC recorder. Wait until the message disappears.

Symptom	Remedy
It takes a long time to copy a file.	<ul style="list-style-type: none">• If the file size of a file is large, it takes a considerable time to finish copying. Wait until the copying is finished.
The transferred files are not displayed.	<ul style="list-style-type: none">• The IC recorder can recognize up to 8 levels of folders transferred to the IC recorder.• If files are incompatible, other than an LPCM(.wav)/MP3(.mp3)/WMA(.wma)/AAC-LC(.m4a) file that the IC recorder supports, they may not be displayed. See page 101.
The IC recorder is not recognized by your computer. A folder/file cannot be transferred from your computer.	<ul style="list-style-type: none">• Disconnect the IC recorder from your computer and reconnect it.• Do not use a USB hub or USB extension cable other than supplied USB connection support cable. Connect the IC recorder directly to your computer or use the supplied USB connection support cable.• Operation is not guaranteed if you use any system requirements other than those described on page 100.• Depending on the USB port position, the IC recorder may not be recognized. If this happens, try another port.
The file transferred from your computer cannot be played back.	<ul style="list-style-type: none">• The file format may differ from those that can be played back using the IC recorder (LPCM(.wav)/MP3(.mp3)/WMA(.wma)/AAC-LC(.m4a)). Check the file name (page 101).
The computer cannot start.	<ul style="list-style-type: none">• If you reboot the computer with the IC recorder connected to the computer, the computer may freeze or may not start properly. Disconnect the IC recorder from the computer and reboot the computer again.

Sound Organizer

Refer to the help files of the Sound Organizer software, too.



Symptom	Cause/Remedy
The Sound Organizer software cannot be installed.	<ul style="list-style-type: none">• The free disk or memory space on the computer is too small. Check the hard disk and memory space.• You are trying to install the software into the operating system that the Sound Organizer software does not support. Install the software into the supported operating system (page 91).• In Windows XP, you have logged on using a user name belonging to a user account with limitations. Or in Windows Vista or Windows 7, you have logged on using a guest account. Make sure to log on using a user name with computer administrator privileges.
The IC recorder cannot be properly connected.	<ul style="list-style-type: none">• Check that the installation of the software has been successful. Also check the connection as follows:<ul style="list-style-type: none">– When using an external USB hub, connect the IC recorder directly to the computer or use the supplied USB connection support cable.– Disconnect and then connect the IC recorder.– Connect the IC recorder to another USB port.• Your computer may be in the system standby/hibernate mode. Do not let your computer enter into the system standby/hibernate mode while being connected to the IC recorder.• Save a backup copy of all of the data stored on the built-in memory or the memory card, and then format the built-in memory or the memory card using the formatting function in the menu (page 79).



Symptom	Cause/Remedy
Playback sound from the computer is low./No sound is emitted from the computer.	<ul style="list-style-type: none">• No sound board is installed.• No speaker is built-in or connected to the computer.• The volume of the sound is turned down.• Turn up the volume on the computer. (Refer to the instruction manual of the computer.)• The volume of WAV files can be changed and saved using the “Increase Volume” feature of the Microsoft Sound Recorder.
Stored files cannot be played back or edited.	You cannot play back files whose file format the Sound Organizer software does not support. Depending on the file format, you cannot use part of editorial features of the software. Refer to the help files of the Sound Organizer software.
The counter or slider moves incorrectly, or noise is heard.	<ul style="list-style-type: none">• This happens when you play back files that you divided. Store a file on your computer first*, and then add it to the IC recorder. (*Select the saving file format that suits the IC recorder you use.)
Operation is slow when there are many files.	<ul style="list-style-type: none">• When the total number of files increases, the operation becomes slower, regardless of the length of the recording time.
Display does not work during saving, adding, or deleting of files.	<ul style="list-style-type: none">• It takes a longer time to copy or delete long files. Wait until the copying is finished. After completing operations, the display works normally.
The software ‘hangs’ when the Sound Organizer software starts up.	<ul style="list-style-type: none">• Do not disconnect the connector of the IC recorder while the computer is communicating with the IC recorder. Otherwise the computer operations become unstable or the data inside the IC recorder may be damaged.• There may be conflict between the software and other driver or application.

Message List

Message	Cause/Remedy
HOLD	<ul style="list-style-type: none">• All the button operations are disabled because the IC recorder is in the HOLD status to prevent unintentional operations. Slide the HOLD/POWER switch towards the center to release the IC recorder from the HOLD status (page 10).
Low Battery	<ul style="list-style-type: none">• The battery is exhausted. Replace the old LR03 (size AAA) alkaline battery with a new one. Or charge the rechargeable battery (page 11) or replace the old rechargeable battery with a new one.
Memory Card Error	<ul style="list-style-type: none">• An error occurred while a memory card was being inserted into the memory card slot. Remove and try inserting it again. If this message persists, use a new memory card.
Memory Card Not Supported	<ul style="list-style-type: none">• A memory card that the IC recorder does not support is inserted. See “About compatible memory cards” on page 36.
Memory Card Locked	<ul style="list-style-type: none">• The memory card is write-protected. A write-protected memory card cannot be used with the IC recorder.
Read Only Memory Card	<ul style="list-style-type: none">• A read-only memory card is inserted. A read-only memory card cannot be used with the IC recorder.
Memory Card Access Denied	<ul style="list-style-type: none">• Since a memory card containing an access control function is inserted, you cannot use it.
Memory Full	<ul style="list-style-type: none">• The remaining memory capacity of the IC recorder is insufficient. Erase some files before recording.
File Full	<ul style="list-style-type: none">• When there are already the maximum number of files in the selected folder or the total number of files stored on the IC recorder has exceeded the maximum, you cannot record a new file. Erase some files before recording.

Message	Cause/Remedy
File Damaged	<ul style="list-style-type: none">• You cannot play back or edit files, because the data of the selected file is damaged.
Format Error	<ul style="list-style-type: none">• The IC recorder cannot be turned on using the computer because there is no copy of the control file required for operation. Format the IC recorder using the formatting function in the menu (page 79). Do not use your computer to format the IC recorder.
Process Error	<ul style="list-style-type: none">• The IC recorder failed in memory access. Remove and then re-insert the battery.• Save a backup copy of your data and format the IC recorder using the menu (page 79).
Stop and Reinsert Memory Card	<ul style="list-style-type: none">• A memory card was inserted during recording or playback. Remove the memory card and insert it while the IC recorder is in the stop mode.
Set Date&Time	<ul style="list-style-type: none">• Set the clock; otherwise, you cannot set the alarm.
Track Marks are Full	<ul style="list-style-type: none">• You can set up to 98 track marks for a file. Cancel unwanted track marks (page 60).
No File	<ul style="list-style-type: none">• The selected folder does not have any files. You cannot move a file or set the alarm, etc., because of this.
No Track Marks	<ul style="list-style-type: none">• There are no track marks when you attempt to erase a track mark or track marks, or divide a file at all the track mark positions.
Low Battery Level	<ul style="list-style-type: none">• You cannot format the memory or erase all the files in a folder because of insufficient battery power. Replace the old LR03 (size AAA) alkaline battery with a new one. Or charge the rechargeable battery (page 11) or replace the old rechargeable battery with a new one.
File Protected	<ul style="list-style-type: none">• The selected file is protected or is a “Read only” file. You cannot erase it. Cancel the protection on the IC recorder or cancel “Read only” on your computer to edit the file using the IC recorder (page 65).

Message	Cause/Remedy
Already Set	<ul style="list-style-type: none"> You set the alarm to play back a file at a date and time previously set on another file. Change the alarm setting.
Past Date/Time	<ul style="list-style-type: none"> You set the alarm when the time has already passed. Check it and set the appropriate date and time (page 52).
Unknown Data	<ul style="list-style-type: none"> This data is not in a file format that is supported by the IC recorder. The IC recorder supports LPCM(.wav)/MP3(.mp3)/WMA(.wma)/AAC-LC(.m4a) files. For details, see “Design and specifications” on page 101. You cannot play back copyright protected files.
Invalid Operation	<ul style="list-style-type: none"> You cannot divide or set a track mark in files in the folder in the playback-only area (the  (Music) tab and the  (Podcast) tab). When a memory card has a bad block on it, the card cannot be written to. Prepare a new memory card to replace the current one. The file name has reached the maximum number of characters; you cannot divide the file. Shorten the file name. The “Divide All Track Marks” function cannot be used because there is a track mark within 0.5 seconds from the dividing position. The “Divide All Track Marks” function cannot be used because there is a track mark within 0.5 seconds from the beginning of a file or the end of a file. The file length is less than 1 second; you cannot divide such a short file. The “Divide Current Position” function cannot be used at a position within 0.5 seconds from the beginning of a file or the end of a file.
New File	<ul style="list-style-type: none"> The file being recorded has reached the maximum size limit (2 GB for an LPCM file, and 1 GB for an MP3 file). The file will be divided automatically and recording will continue as a new file.
Invalid when Noise Cut is ON	<ul style="list-style-type: none"> When the noise cut function is effective, the effect function does not work. Cancel the noise cut setting (page 46).

Message	Cause/Remedy
Change Folder	<ul style="list-style-type: none">• If there are no files in the  or  folder, no folders are displayed in the display window. Only a folder with a file will be displayed.
Cannot Divide - Exceeds Max 199 Files in Folder	<ul style="list-style-type: none">• When there are already 199 files in the selected folder or the total number of files stored on the IC recorder exceeds the maximum, you cannot divide a file. Erase some files before dividing a file.
Same File Name Exists	<ul style="list-style-type: none">• A file of the same file name already exists in the folder when a file is divided, or a file is copied or moved.
No Memory Card	<ul style="list-style-type: none">• There is no memory card inserted into the memory card slot when you attempt to set the “Select Memory,” or “File Copy” menus.
Erased Track Marks too near Divide Point	<ul style="list-style-type: none">• When there is a track mark set within 0.5 seconds from the dividing position, the track mark is automatically erased.
No operation with Memory Card	<ul style="list-style-type: none">• You cannot set an alarm in a file stored on a memory card. Switch the memory media of the IC recorder to “Built-In Memory” (page 38, 39).
System Error	<ul style="list-style-type: none">• A system error other than the above has occurred. Remove the battery and re-insert it.

System Limitations

There are some system limitations of the IC recorder. Troubles as mentioned below are not malfunctions of the IC recorder.

Symptom	Cause/Remedy
You cannot record files up to the maximum recording time.	<ul style="list-style-type: none">• If you record files in a mixture of the recording modes, the recordable time varies from the maximum recording time of the highest recording mode to those of the lowest recording mode.• The sum of the number on the counter (elapsed recording time) and the remaining recording time may be less than the IC recorder's maximum recording time.
You cannot display or play back music files in order.	<ul style="list-style-type: none">• If you have transferred music files using your computer, those files may not be transferred in order of transfer because of system limitations. If you transfer music files from your computer to the IC recorder one by one, you can display and play back the music files in transferred order.
A file is divided automatically.	<ul style="list-style-type: none">• The file being recorded has reached the maximum size limit (2 GB for an LPCM file, and 1 GB for an MP3 file). Therefore it is automatically divided.
You cannot enter lower-case characters.	<ul style="list-style-type: none">• Depending on the combination of the characters used for the folder name that was made on your computer, those characters may change to all capitals.
“□” is displayed in place of a folder name, title, artist name, or file name.	<ul style="list-style-type: none">• A character which cannot be displayed on the IC recorder has been used. Using your computer, replace it with one which can be displayed on the IC recorder.
When you set A-B repeat playback, the set positions move a little.	<ul style="list-style-type: none">• Depending on the files, the set positions may move.
The remaining recording time becomes shorter when you divide a file.	<ul style="list-style-type: none">• You need a certain amount of free space for a file management area to divide a file, therefore the remaining recording time will be shortened.

Display Window Guide

Display when stopped

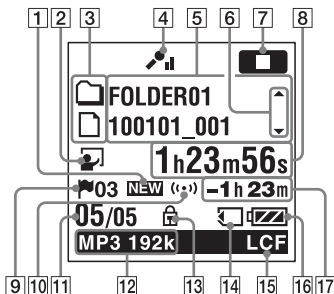

- 1 Newly arriving podcast indication
- 2 Scene select indication
Displays the currently selected scene used for recording. Appears when a scene is set.
 - Meeting
 - Voice Notes
 - Interview
 - Lecture
 - Audio IN
 - My Scene

- 3 File information type indicator
 - Folder where you can record a file
 - Folder for playback only
 - Folder for podcast files
 - Title name
 - Artist name
 - File name
- 4 Microphone sensitivity indicator
 - High
 - Medium
 - Low
- 5 File information
Displays the information for each file according to the file information type (folder name, title name, artist name, file name).
- 6 File information switch operation guide
You can switch the file information display in order by pushing ▲ or ▼ on the control button.
- 7 Operation mode indicator
Displays the following, depending on the current operation of the IC recorder.
 - stop
 - playback
 - REC: recording

●II : recording standby/recording pause (flashing)

VOR REC : recording with the VOR function

VOR ●II : recording pause with the VOR function (flashing)

If you press **● REC/PAUSE** to pause recording when “VOR” is set to “ON” in the menu, only “**●II**” flashes.

SYNC REC : synchronized recording

SYNC ●II : synchronized recording pause (flashing)

◀▶ : review/fast backward, cue/fast forward

◀▶ : going backward/forward continuously

8 Elapsed time/Remaining time/
Recording date and time indication

9 Track mark indicator

Displays the track mark number just before the current position. Appears when a track mark is set for a file.

10 Alarm indicator

Appears when the alarm is set in a file.

11 File number

The selected file number is displayed in the numerator and the total number of files in the folder is displayed in the denominator.

12 Recording mode indicator

Displays the recording mode set using the menu when the IC recorder is in the stop mode, and displays the current recording mode when the IC recorder is in the playback or recording mode.

LPCM 44/16 : LPCM file recorded or transferred with the IC recorder

MP3 8k , **MP3 48k** , **MP3 128k** ,

MP3 192k : MP3 file recorded or transferred with the IC recorder

When the files are transferred from your computer, file formats only (**LPCM** / **MP3**) are displayed.

WMA : WMA files transferred

AAC : AAC-LC files transferred

Displays as follows when the IC recorder cannot get the recording mode.

--- : Unknown

13 Protect indicator

Appears when the protection is set for a file.

14 Memory card indication

When “Memory Card” is selected as “Select Memory,” the indication is displayed. When “Built-In Memory” is selected, no indication is displayed.

- 15** LCF (Low Cut Filter) indicator
Appears when “LCF(Low Cut)” is set to “ON” in the menu.
- 16** Battery indicator
- 17** Remaining recording time
Displays the remaining recording time in hours, minutes, and seconds.
If there is more than 10 hours time remaining, the time is displayed in hours.
If there is more than 10 minutes and less than 10 hours time remaining, the time is displayed in hours and minutes.
If there is less than 10 minutes time remaining, the time is displayed in minutes and seconds.

Display when recording

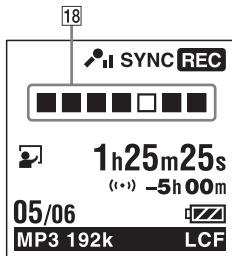

- 18** Recording progress animation display
Displays the progress of an auto (AGC), VOR, or synchronized recording in animation.

Display during playback

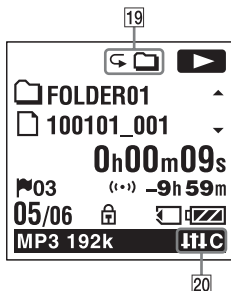

N-CUT : Noise cut

JfP : Pop

JfR : Rock

JfJ : Jazz

BA1 : Bass 1

BA2 : Bass 2

JfC : Custom



19 Playback mode indicator

1: Appears when a file is played back.

 : Appears when files in one folder are played back continuously.

ALL: Appears when all the files are played back continuously.

 1: Appears when one file is played back repeatedly.

  : Appears when files in one folder are played back repeatedly.

 ALL: Appears when all the files are played back repeatedly.

20 Noise cut/Effect indicator

Appears when the noise cut function is effective or “Effect” is set in the menu.

Display in the HOLD status

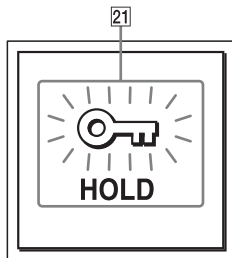

21 HOLD indicator

Appears when the IC recorder is in the HOLD status to prevent unintentional operations.

To release the HOLD status, slide the HOLD/POWER switch towards the center (page 10).

Index

A

AAC-LC files	101
A-B repeat	51
Adjusting the volume	24, 44
Alarm	52, 67, 74
Alkaline battery	104
Auto (AGC) recording	21

B

Battery indicator	13
Battery life	104
Built-in microphones	21

C

Changing the Scene Select settings	33, 67, 69
Connecting the IC recorder to your computer	80
Copying a file to the other memory media	56, 67, 74
Copying files to your computer	86
Copying music files to the IC recorder	87
Cue	45

D

Display the current date and time	17
Dividing a file at all the track mark positions	63, 67, 75
Dividing a file at the current position	62, 67, 74
DPC (Digital Pitch Control)	47

E

Easy search	45, 67, 73
Editing files	55
Effect	48, 67, 72
Erasing	28
Erasing a track mark	60, 67, 75
Erasing all files in a folder	57, 67, 75
Erasing all the track marks	61, 67, 75
External microphone	40

F

Folder	19, 23, 55, 81
--------------	----------------

H

HOLD	10
HOLD/POWER switch	10, 14

I	
Index to parts and controls	
Display window	119
Front	9
Rear	9
Input selection	40, 67, 71
M	
Maintenance	97
Memory card	36, 98
Memory Stick Micro™ (M2™)	36, 83
Menu	
Alarm	67, 74
Auto Power Off	68, 78
Backlight	68, 76
Beep	68, 77
Date&Time	68, 77
Display	68, 75
Divide All Track Marks	67, 75
Divide Current Position	67, 74
Easy Search	67, 73
Effect	67, 72
Erase All	67, 75
Erase All Track Marks	67, 75
Erase Track Mark	67, 75
File Copy	67, 74
Format	68, 79
Language	68, 77
LCF(Low Cut)	67, 71
LED	68, 76
Making settings	66
Menu settings	67
Mic Sensitivity	67, 70
Move File	67, 74
Noise Cut	67, 72
Play Mode	67, 73
Protect	67, 74
REC Mode	67, 70
Scene Select	67, 69
Select Input	67, 71
Select Memory	68, 76
SYNC REC	67, 71
Time Display	68, 77
USB Charge	68, 78
VOR	67, 71
Message list	114
microSD/microSDHC	36, 83
Monitoring the recording	44
Moving a file	55, 67, 74
MP3 files	101
N	
Noise	97
Noise cut	46, 67, 72

P	
Pause recording	22
Playback	23, 45
Playback modes	50, 67, 73
Podcast	90
Precautions	97
Protecting a file	65, 67, 74
R	
Rechargeable battery	11, 95, 104
Recharging the battery	11
Recording	19, 30
Recording from a telephone	41
Recording from other equipment	41
Recording time	103
Recording with other equipment	54
Review	22, 45
S	
Scene selection	30
Selecting a folder	19
Setting the clock	15, 68, 77
Setting the language	18, 68, 77
Sound Organizer	90
Specifications	100
Switching the memory	38, 68, 76
Synchronized recording	42, 67, 71
System limitations	118
System requirements	91, 100
T	
Tab view	26
Track mark	59
Troubleshooting	105
U	
USB AC adaptor	95
USB memory	89
Using the IC Recorder with Your Computer	80
V	
VOR (Voice Operated Recording)	35, 67, 71
W	
WMA files	101

<http://www.sony.net/>

© 2011 Sony Corporation

Printed in China



* 4 1 9 6 5 4 6 1 2 * (1)