

Register your product and get support at  
[www.philips.com/support](http://www.philips.com/support)

55PFL4706  
46PFL4706  
40PFL4706



---

EN User Manual

---

FR Manuel d'Utilisation

---

ES Manual del Usuario

**EN:** For further assistance, call the customer support service in your country.

- To obtain assistance in the U.S.A., Canada, Puerto Rico, or the U.S. Virgin Islands, contact Philips Customer Care Center at **1-866-309-0841**
- To obtain assistance in Mexico, contact Philips Customer Care Center at **01 800 504 62 00**

Enter below the model and serial numbers located on the back and right side of the TV cabinet.

**FR:** Pour obtenir de l'aide supplémentaire, communiquez avec le centre de service à la clientèle de votre pays.

- Pour obtenir de l'aide aux États-Unis, au Canada, à Puerto Rico ou aux Îles Vierges américaines, communiquez avec le centre de service à la clientèle Philips au : **1-866-309-0841**
- Pour obtenir l'aide au Mexique, entrez en contact avec le centre de soin de client de Philips à **01 800 504 62 00**

Entrer ci dessous le modèle et le numéro de série situés derrière à droite sur le dos du téléviseur.

**ES:** Para obtener más información, llame al servicio de soporte al cliente de su país.

- Para obtener asistencia en los Estados Unidos, en Canadá, Puerto Rico o en las Islas Vírgenes de los Estados Unidos, comuníquese con Centro de atención al cliente de Philips al **1-866-309-0841**
- Solo para México CENTRO DE ATENCIÓN A CLIENTES LADA. **01 800 504 62 00** Solo Para México.

Escriba a continuación el modelo y número de serie que están localizados en lado derecho y parte posterior de el gabinete de el televisor.

**Lea esta manual antes de usar el producto**

MODEL NUMBER

SERIAL NUMBER

**PHILIPS**

# Contents

<b>1 Notice</b>	4	<b>7 Install channels</b>	35
		Selecting your menu language	35
<b>2 Important</b>	5	Autoprogram	35
Product information	5	Weak channel installation	35
Screen care	5	Installation mode	35
Environmental care	5	Uninstall channels	35
Regulatory notices	5	Return your settings to default values	35
<b>3 Your TV</b>	6	<b>8 Update your TV software</b>	36
Side controls and indicators	6	Checking your current software version	36
Remote control	6	Preparing for the software update by USB	36
		Updating software	36
<b>4 Get started</b>	8	<b>9 Connect devices</b>	38
Supplied accessories	8	Connection overview	38
Stand assembly	8	Selecting your connection quality	39
Mounting stand onto TV	8	Connecting your devices	39
Positioning the TV	8	Add devices	42
Installing the remote control batteries	8	Remove devices	42
Connecting the antenna or cable	9	<b>10 Troubleshooting</b>	43
Managing cables	10	Downloading an electronic copy	43
Connecting the AC power cord	10	Contact us	43
Switching on and initial setup	11	<b>11 Specifications</b>	44
		<b>12 Warranty</b>	45
<b>5 Use your TV</b>	12	<b>13 Index</b>	46
Switching on your TV and putting it in standby mode	12	<b>License</b>	end of book
Switching channels	12		
Adjusting volume	13		
Watching channels from a set-top box	13		
Watching connected devices	13		
Watching a Blu-ray disc	13		
<b>6 Use more of your TV</b>	14		
Access TV menus	14		
Philips Wireless MediaConnect	15		
View photos, play music and watch videos using DLNA	15		
Net TV	17		
Enjoying vTuner	17		
Pandora operations	19		
Using Twitter	20		
Changing picture and sound settings	22		
Create and use lists of favorite channels	24		
Setting the clock	25		
Closed caption	25		
Sleeptimer	26		
Child and rating locks	26		
Use Philips EasyLink	29		
EasyLink	29		
Set your location to home	30		
Network	30		
View photos and play music, and watch videos on a USB storage device	33		

**Note:** Individual menu items in the TV are dynamic and will change based on type of input media, options enabled/disabled, and some other factors such as the version of the software installed on the TV.

**Return your Product Registration Card or register online at [www.philips.com/support](http://www.philips.com/support) today to get the very most from your purchase.**

Registering your model with Philips makes you eligible for all of the valuable benefits listed below, so don't miss out. Complete and return your Product Registration Card at once, **or register online at [www.philips.com/support](http://www.philips.com/support)** to ensure:

### \*Product Safety Notification

By registering your product, you'll receive notification - directly from the manufacturer - in the rare case of a product recall or safety defect.

### \*Additional Benefits

Registering your product guarantees that you'll receive all of the privileges to which you're entitled, including special money-saving offers.

Know these **safety symbols**



This "bolt of lightning" indicates uninsulated material within your unit may cause an electrical shock. For the safety of everyone in your household, please do not remove product covering.



The "exclamation point" calls attention to features for which you should read the enclosed literature closely to prevent operating and maintenance problems.

**WARNING:** To reduce the risk of fire or electric shock, this apparatus should not be exposed to rain or moisture and objects filled with liquids, such as vases, should not be placed on this apparatus.

**CAUTION:** To prevent electric shock, match wide blade of plug to wide slot, fully insert.

**ATTENTION:** Pour éviter les choc électriques, introduire la lame la plus large de la fiche dans la borne correspondante de la prise et pousser jusqu'au fond.

**PHILIPS**

Visit our World Wide Web Site at <http://www.philips.com/support>

## CHILD SAFETY:

It Makes A Difference How and Where You Use Your Flat Panel Display

Congratulations on your purchase! As you enjoy your new product, please keep these safety tips in mind:

### THE ISSUE

- The home theater entertainment experience is a growing trend and larger flat panel displays are popular purchases. However, flat panel displays are not always supported on the proper stands or installed according to the manufacturer's recommendations.
- Flat panel displays that are inappropriately situated on dressers, bookcases, shelves, desks, speakers, chests or carts may fall over and cause injury.

### THIS MANUFACTURER CARES!

- The consumer electronics industry is committed to making home entertainment enjoyable and safe.



### TUNE INTO SAFETY

- One size does NOT fit all. Follow the manufacturer's recommendations for the safe installation and use of your flat panel display.
- Carefully read and understand all enclosed instructions for proper use of this product.
- Don't allow children to climb on or play with furniture and television sets.
- Don't place flat panel displays on furniture that can easily be used as steps, such as a chest of drawers.
- Remember that children can become excited while watching a program, especially on a "larger than life" flat panel display. Care should be taken to place or install the display where it cannot be pushed, pulled over, or knocked down.
- Care should be taken to route all cords and cables connected to the flat panel display so that they cannot be pulled or grabbed by curious children.



### WALL MOUNTING: IF YOU DECIDE TO WALL MOUNT YOUR FLAT PANEL DISPLAY, ALWAYS:

- Use a mount that has been recommended by the display manufacturer and/or listed by an independent laboratory (such as UL, CSA, ETL).
- Follow all instructions supplied by the display and wall mount manufacturers.
- If you have any doubts about your ability to safely install your flat panel display, contact your retailer about professional installation.
- Make sure that the wall where you are mounting the display is appropriate. Some wall mounts are not designed to be mounted to walls with steel studs or old cinder block construction. If you are unsure, contact a professional installer.
- A minimum of two people are required for installation. Flat panel displays can be heavy.

 **CEA**  
Consumer Electronics Association  
[www.CE.org/safety](http://www.CE.org/safety)

## IMPORTANT SAFETY INSTRUCTIONS

### Read before operating equipment

1. Read these instructions.
2. Keep these instructions.
3. Heed all warnings.
4. Follow all instructions.
5. Do not use this apparatus near water.
6. Clean only with a dry cloth.
7. Do not block any of the ventilation openings. Install in accordance with the manufacturer's instructions.
8. Do not install near any heat sources such as radiators, heat registers, stoves, or other apparatus (including amplifiers) that produce heat.
9. Do not defeat the safety purpose of the polarized or grounding-type plug. A polarized plug has two blades with one wider than the other. A grounding type plug has two blades and third grounding prong. The wide blade or third prong are provided for your safety. When the provided plug does not fit into your outlet, consult an electrician for replacement of the obsolete outlet.
10. Protect the power cord from being walked on or pinched particularly at plugs, convenience receptacles, and the point where they exit from the apparatus.
11. Only use attachments/accessories specified by the manufacturer.
12.  Use only with a cart, stand, tripod, bracket, or table specified by the manufacturer, or sold with the apparatus. When a cart is used, use caution when moving the cart/apparatus combination to avoid injury from tip-over.
13. Unplug this apparatus during lightning storms or when unused for long periods of time.
14. Refer all servicing to qualified service personnel. Servicing is required when the apparatus has been damaged in any way, such as power-supply cord or plug is damaged, liquid has been spilled or objects have fallen into apparatus, the apparatus has been exposed to rain or moisture, does not operate normally, or has been dropped.
15. This product may contain lead. Disposal of these materials may be regulated due to environmental considerations. For disposal or recycling information, please contact your local authorities or the Electronic Industries Alliance: [www.eiae.org](http://www.eiae.org).
16. **Damage Requiring Service** - The appliance should be serviced by qualified service personnel when:
  - A. The power supply cord or the plug has been damaged; or
  - B. Objects have fallen, or liquid has been spilled into the appliance; or
  - C. The appliance has been exposed to rain; or
  - D. The appliance does not appear to operate normally or exhibits a marked change in performance; or
  - E. The appliance has been dropped, or the enclosure damaged.
17. **Tilt/Stability** - All televisions must comply with recommended international global safety standards for tilt and stability properties of its cabinets design.
  - Do not compromise these design standards by applying excessive pull force to the front, or top, of the cabinet which could ultimately overturn the product.
  - Also, do not endanger yourself, or children, by placing electronic equipment/toys on the top of the cabinet. Such items could unsuspectingly fall from the top of the set and cause product damage and/or personal injury.
18. **Wall or Ceiling Mounting** - The appliance should be mounted to a wall or ceiling only as recommended by the manufacturer.
19. **Power Lines** - An outdoor antenna should be located away from power lines.
20. **Outdoor Antenna Grounding** - If an outside antenna is connected to the receiver, be sure the antenna system is grounded so as to provide some protection against voltage surges and built up static charges. Section 810 of the National Electric Code, ANSI/NFPA No. 70-1984, provides information with respect to proper grounding of the mats and supporting structure grounding of the lead-in wire to an antenna-discharge unit, size of grounding connectors, location of antenna-discharge unit, connection to grounding electrodes and requirements for the grounding electrode. See Figure below.
21. **Objects and Liquid Entry** - Care should be taken so that objects do not fall and liquids are not spilled into the enclosure through openings.
  - a) Warning: To reduce the risk of fire or electric shock, this apparatus should not be exposed to rain or moisture and objects filled with liquids, such as vases should not be placed on this apparatus.
22. **Battery Usage CAUTION** - To prevent battery leakage that may result in bodily injury, property damage, or damage to the unit:
  - Install all batteries correctly, with + and - alignment as marked on the unit.
  - Do not mix batteries (old and new or carbon and alkaline, etc.)
  - Remove batteries when the unit is not used for a long time.

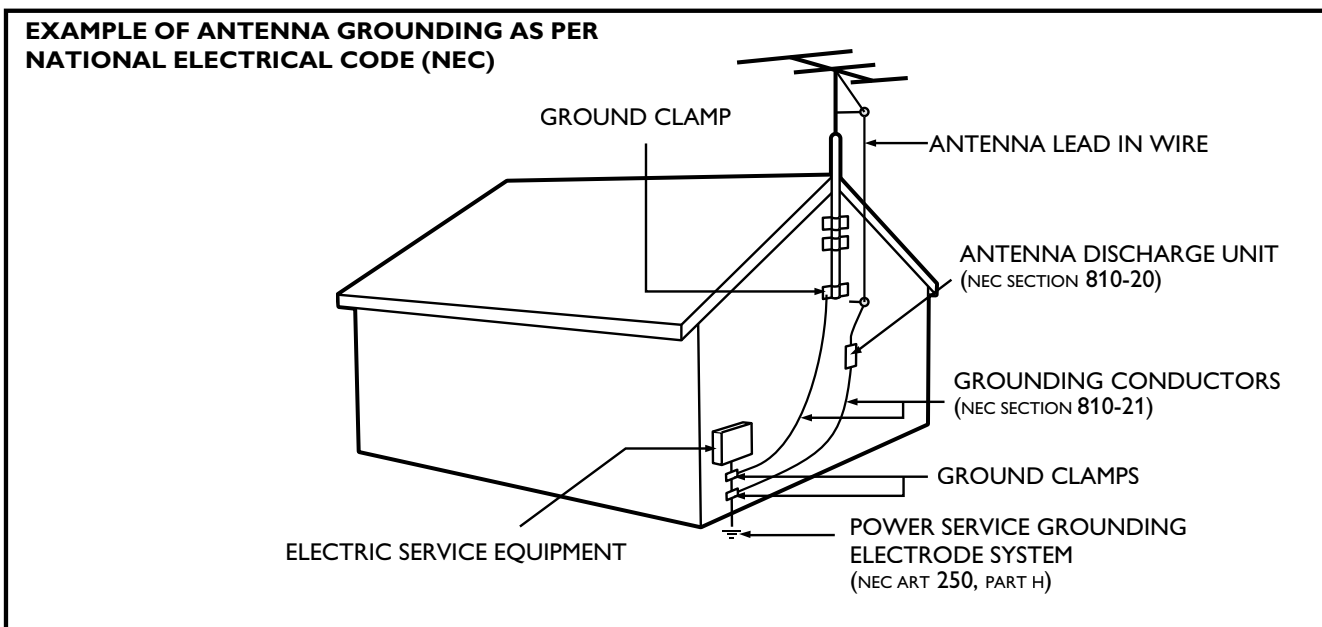

**Note to the CATV system installer:** this reminder is provided to call the CATV system installer's attention to Article 820-40 of the NEC that provides guidelines for proper grounding and, in particular, specifies that the cable ground shall be connected to the grounding system of the building, as close to the point of cable entry as practical.

# 1 Notice

Specifications are subject to change without notice. Trademarks are the property of Koninklijke Philips Electronics N.V. or their respective owners. P&F USA reserves the right to change products at any time without being obliged to adjust earlier supplies accordingly.

The material in this manual is believed adequate for the intended use of the system. If the product, or its individual modules or procedures, are used for purposes other than those specified herein, confirmation of their validity and suitability must be obtained. P&F USA warrants that the material itself does not infringe any United States patents. No further warranty is expressed or implied.

P&F USA cannot be held responsible neither for any errors in the content of this document nor for any problems as a result of the content in this document. Errors reported to P&F USA will be adapted and published on the P&F USA support website as soon as possible.

## Pixel characteristics

This LCD product has a high number of color pixels. Although it has effective pixels of 99.999% or more, black dots or bright points of light (red, green or blue) may appear constantly on the screen. This is a structural property of the display (within common industry standards) and is not a malfunction.

## Warranty

No components are user serviceable. Do not open or remove covers to the inside of the product. Repairs may only be done by Service Centers and official repair shops. Failure to do so shall void any warranty, stated or implied.

Any operation expressly prohibited in this manual, any adjustments, or assembly procedures not recommended or authorized in this manual shall void the warranty.

## Federal Communications Commission Notice

This equipment has been tested and found to comply with the limits for a Class B digital device, pursuant to part 15 of the FCC Rules. These limits are designed to provide reasonable protection against harmful interference in a residential installation. This equipment generates, uses, and can radiate radio frequency energy and, if not installed and used in accordance with the instructions, may cause harmful interference to radio communications. However, there is no guarantee that interference will not occur in a particular installation. If this equipment does cause harmful interference to radio or television reception, which can be determined by turning the equipment off and on, the user is encouraged to try to correct the interference by one or more of the following measures:

- Reorient or relocate the receiving antenna.
- Increase the separation between the equipment and the receiver.
- Connect the equipment into an outlet on a circuit different from that to which the receiver is connected.
- Consult the dealer or an experienced radio or television technician for help.

## Declaration of Conformity

**Trade Name:** PHILIPS  
**Responsible Party:** P&F USA, Inc.  
**Model:** 55PFL4706, 46PFL4706, 40PFL4706  
**Address:** PO Box 430 Daleville, IN 47334-0430 U.S.A.  
**Telephone Number:** 1-866-309-0841

## Modifications

The FCC requires the user to be notified that any changes or modifications made to this device that are not expressly approved by Philips Consumer Electronics may void the user's authority to operate the equipment.

## Cables

Connections to this device must be made with shielded cables with metallic RFI/EMI connector hoods to maintain compliance with FCC Rules and Regulations.

## Canadian notice

Standard Television Receiving Apparatus, Canada BETS-7/NTMR-7. This Class B digital apparatus meets all requirements of the Canadian Interference-Causing Equipment Regulations.

## FCC Caution: Any changes or modifications not expressly approved by the party responsible for compliance could void the user's authority to operate this equipment.

This transmitter must not be co-located or operating in conjunction with any other antenna or transmitter:

## Country Code Statement

For product available in the USA market, only channel 1~11 can be operated. Selection of other channels is not possible.

To maintain compliance with FCC RF exposure requirements, use only belt-clips, holsters or similar accessories that do not contain metallic components in its assembly. The use of accessories that do not satisfy these requirements may not comply with FCC RF exposure requirements, and should be avoided.

## FCC Radiation Exposure Statement

This equipment is compliance with SAR for general population/ uncontrolled exposure limits in ANSI/IEEE C95.1-1999 and had been tested in accordance with the measurement methods and procedures specified in OET Bulletin 65 Supplement C. This equipment should be installed and operated with minimum distance 2.5cm between the radiator & your body.

This device complies with Industry Canada license-exempt RSS standard(s). Operation is subject to the following two conditions: (1) this device may not cause interference, and (2) this device must accept any interference, including interference that may cause undesired operation of the device.

## Copyright

All other registered and unregistered trademarks are the property of their respective owners.



ENERGY STAR® is a joint program of the U.S. Environmental Protection Agency and the U.S. Department of Energy helping us all save money and protect the environment through energy efficient products and practices.

## Consumer Notice:

This TV has been set to maximize energy efficiency while delivering the best possible picture using the factory installed home mode settings. Changing or enabling other features in this TV (e.g. brightened backlighting) will possibly increase energy consumption beyond the original ENERGY STAR® qualified limits.



SRS TruSurround HD™ creates an immersive, feature-rich surround sound experience from two speakers, complete with rich bass, high frequency detail and clear dialog.

SRS® is a trademark of SRS Labs, Inc. TruSurround HD technology is incorporated under license from SRS Labs, Inc.



HDMI, the HDMI Logo, and High-Definition Multimedia Interface are trademarks or registered trademarks of HDMI Licensing LLC in the United States and other countries.



Manufactured under license from Dolby Laboratories. Dolby and the double-D symbol are trademarks of Dolby Laboratories.



DLNA®, the DLNA Logo and DLNA CERTIFIED® are trademarks, service marks, or certification marks of the Digital Living Network Alliance.



Netflix and the Netflix logo are trademarks or registered trademarks of Netflix, Inc.



Film Fresh and the Film Fresh logo are registered trademarks of Film Fresh Inc.



BLOCKBUSTER name, design and related marks are trademarks of Blockbuster Inc.



VUDU™ is a trademark of VUDU, Inc.

CloudTV™

CloudTV™ (CloudTV™ by ActiveVideo®) technology provided under license from ActiveVideo Networks, Inc. U.S. and Foreign Patents apply. CloudTV™ and the "CloudTV™" logo are proprietary trademarks of ActiveVideo Networks, Inc.

PANDORA®  
internet radio

Pandora is a registered trademark of Pandora Media, Inc.

twitter™

Twitter is a trademark of Twitter, Inc.



vTuner is a trademark of Nothing Else Matters Software, Ltd.



® Kensington and Micro Saver are registered US trademarks of ACCO World corporation with issued registrations and pending applications in other countries throughout the world.

Wireless)))  
(((((((LAN

Media connect

Portions of this software are copyright © The FreeType Project (www.freetype.org).

The American Academy of Pediatrics discourages television viewing for children younger than two years of age.

## 2 Important

Registering your model with Philips makes you eligible for all of the valuable benefits listed below, so don't miss out.

Complete and return your Product Registration Card at once, or register online at [www.philips.com/support](http://www.philips.com/support) to ensure:

- **Product Safety Notification**  
By registering your product you receive notification - directly from the manufacturer - in the rare case of a product recall or safety defect.
- **Additional Benefits of Product Ownership**  
Registering your product guarantees that you receive all of the privileges to which you're entitled, including special money-saving offers.

### For further assistance

For further assistance, call the customer support service in your country.

- To obtain assistance in the U.S.A., Canada, Puerto Rico, or the U.S. Virgin Islands, contact Philips Customer Care Center at **1-866-309-0841**

### Product information

This TV consumes minimal energy in standby mode to minimize environmental impact. The active power consumption is given on the type plate at the back of the TV. The model and serial numbers of your TV can be found on the back and right side of the TV as well as on the packaging.

### Screen care

- Avoid stationary images as much as possible. Stationary images are images that remain on-screen for extended periods of time. Examples include: on-screen menus, black bars and time displays. If you must use stationary images, reduce screen contrast and brightness to avoid screen damage.
- Unplug the TV before cleaning.
- Clean the TV screen and frame with a soft cloth. Never use substances such as alcohol, chemicals or household cleaners on the TV screen.
- Risk of damage to the TV screen! Never touch, push, rub or strike the screen with any object.
- To avoid deformations and color fading, wipe off water drops as soon as possible.

### Environmental care

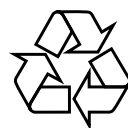

The packaging of this product is intended to be recycled. Contact your local authorities for information about how to recycle the packaging. For product recycling information, please visit - [www.recycle.philips.com](http://www.recycle.philips.com)

### End of life directives



Philips pays a lot of attention to produce environment-friendly products in green focal areas. Your new TV contains materials which can be recycled and reused. At the end of its life, specialized companies can dismantle the discarded TV to concentrate the reusable materials and to minimize the amount of materials to be disposed of. Please ensure you dispose of your old TV according to local regulations.

### Disposal of used batteries

The batteries supplied do not contain the heavy metals mercury and cadmium. Nevertheless, in many areas batteries may not be disposed of with your household waste. Please ensure you dispose of batteries according to local regulations.

### Regulatory notices



#### Warning

To reduce the risk of fire or electric shock, this apparatus should not be exposed to rain or moisture. Objects filled with liquids, such as vases, should not be placed on this apparatus.



#### Caution

To prevent electric shock, match the wide blade of the plug to the wide slot, fully inserted.

Do not place the unit on the furniture that is capable of being tilted by a child and an adult leaning, pulling, standing or climbing on it. A falling unit can cause serious injury or even death.

This apparatus should not be placed in a built-in installation such as a bookcase or rack unless proper ventilation is provided. Make sure to leave a space of 4 inches (10cm) or more around this apparatus.

# 3 Your TV

Congratulations on your purchase, and welcome to Philips! To fully benefit from the support that Philips offers, register your product at [www.philips.com/support](http://www.philips.com/support)

## Side controls and indicators

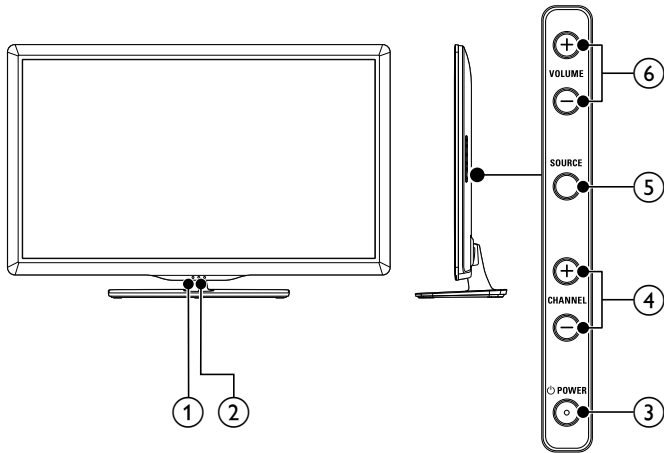

- ① **Ambient light sensor**  
Adjusts backlight for the best picture quality by dynamically adjusting the backlight intensity in accordance with lighting condition in the room when **[Active control]** is set to **[On with Light Sensor]**. Please ensure the room lighting is stable and the light sensor is not blocked.
- ② **Standby indicator / Remote control sensor**
- ③ **POWER**  
Switches the TV on or puts it in standby mode. The TV is not powered off completely unless it is physically unplugged.
- ④ **CHANNEL +/-**  
Switches to the next or previous channel.
- ⑤ **SOURCE**  
Selects connected devices.
- ⑥ **VOLUME +/-**  
Increases or decreases volume.

## Remote control

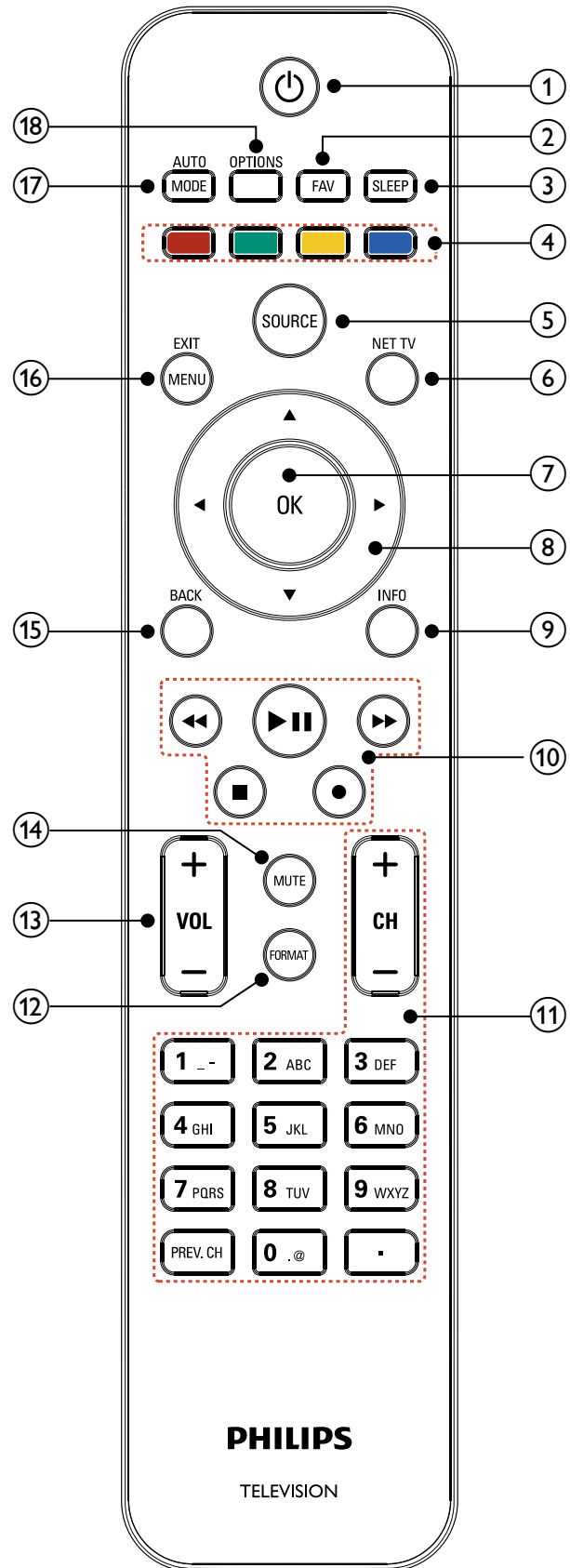

- ① **⏻ (standby-On)**  
Switches the TV on or puts it in standby mode. The TV is not powered off completely unless it is physically unplugged.
- ② **FAV**  
Displays a list of all channels marked as favorite.  
(Includes subchannels)
- ③ **SLEEP**  
Sets a delay after which the TV switches to standby.
- ④ **Color buttons (red/green/yellow/blue)**  
Selects tasks or options.
- ⑤ **SOURCE**  
Selects connected devices.
- ⑥ **NET TV**  
Displays the Net TV menu.
- ⑦ **OK**  
Activates a selection or accesses the menu.
- ⑧ **▲▼◀▶ (navigation buttons)**  
Navigates through the menus.
- ⑨ **INFO**  
Displays information about the TV channel or accessory device.  
The quality and accuracy of the information depends on the broadcaster. You might see a difference in broadcast time if the broadcast is from a different time zone.
- ⑩ **EasyLink buttons**
  - ◀◀ **(backward)**  
Searches backward.
  - ▶▶ **(forward)**  
Searches forward.
  - ▶|| **(play/pause)**  
Starts, pauses or resumes playback.
  - **(record)**  
Starts or stops video recording.
  - **(stop)**  
Stops playback.
- ⑪ **CH +/-**  
Switches to the next or previous channel.  
**Number buttons**  
Select a channel, page, setting or input characters.
  - **(Dot)**  
Press the dot (•) for digital channels.
  - PREV. CH**  
Returns to the previously viewed channel.
- ⑫ **FORMAT**  
Selects a picture format. (See 'Changing picture format' on page 23.)
- ⑬ **VOL +/-**  
Increases or decreases volume.
- ⑭ **MUTE**  
Mutes or unmutes audio.
- ⑮ **BACK**  
Returns to a previous screen.
- ⑯ **MENU/EXIT**  
Toggles the home menu on or off.
- ⑰ **AUTO MODE**  
Cycles through preset picture and sound settings.  
(See 'Using auto mode' on page 24.)
- ⑱ **OPTIONS**  
Displays a list of menu items applicable to the highlighted object or screen.



# 4 Get started

## Supplied accessories

- Remote Control
- AC Power cord
- User Manual
- Box-inserts
- Double sems screws  
(M4 x 16 double sems screw x 6 : 55PFL4706/46PFL4706)  
(M4 x 14 double sems screw x 4 : 40PFL4706)
- 2 x AAA, 1.5V Batteries
- Cable management tie
- Quick Start Guide

### Note

- If you lose the stand mounting screws, please purchase the above mentioned double screws at your local store.
- To wall mount the TV, refer to the Quick Start Guide.

## Stand assembly

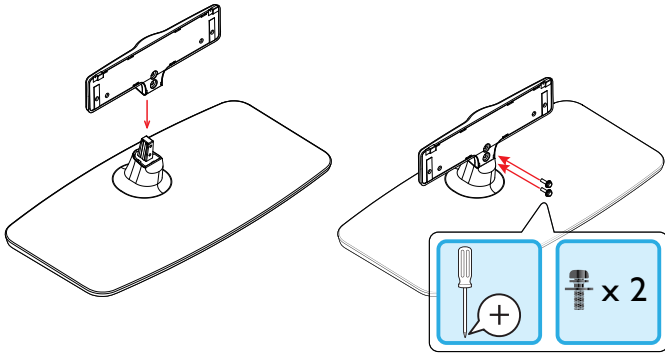

## Mounting stand onto TV

Applicable to TVs without mounted stands.

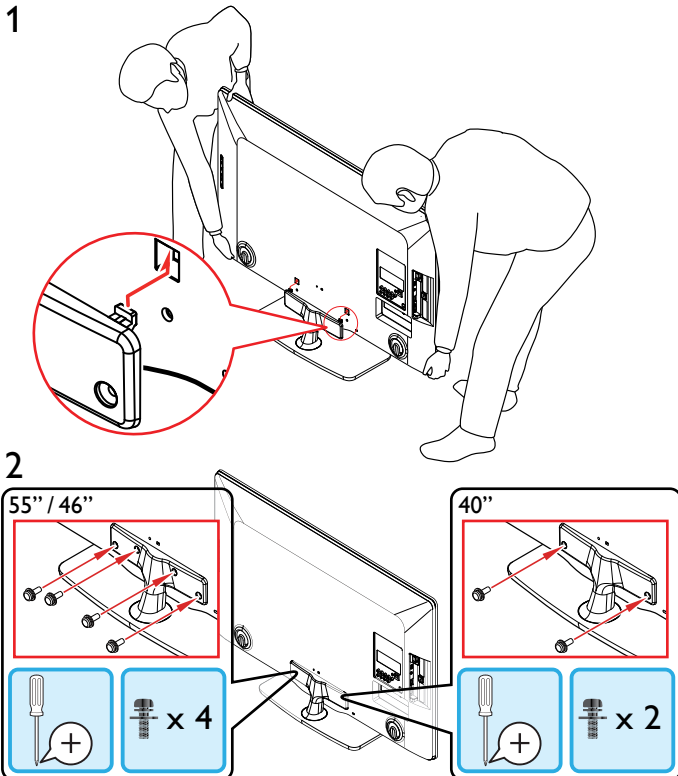

## Positioning the TV

### Warning

- Do not insert the AC power cord into the power socket outlet before all the connections are made.
- Large screen TVs are heavy, 2 people are required to carry and handle a large screen TV.
- Before you move the TV, disconnect attached cables to prevent damage to connectors.

In addition to reading and understanding safety instructions, consider the following before positioning your TV:

- Ensure that you always have easy access to the AC power cord or plug to disconnect the TV from the power.
- If the TV is mounted on a swivel, ensure that no strain is placed on the AC power cord when the TV is swiveled. Strain on the AC power cord can loosen connections.
- The ideal viewing distance for watching TV is three times its screen size.
- Position the TV where light does not fall on the screen.
- Connect your devices before you position the TV.

## Using a Kensington lock

There is a Kensington security slot on the back of the TV. Prevent theft by looping a Kensington lock between the slot and a permanent object, such as a heavy table.

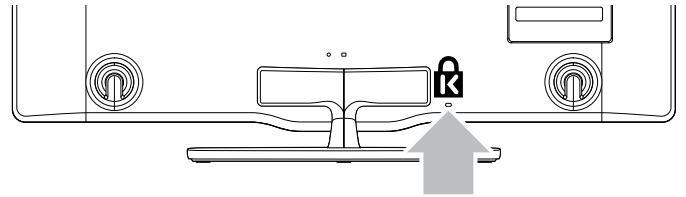

## Installing the remote control batteries

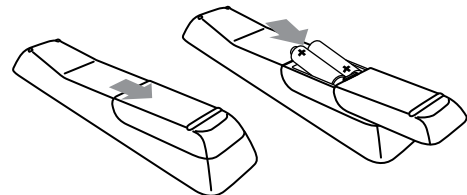

- 1 Slide the battery cover off the back of the remote control.
- 2 Insert the 2 supplied batteries (AAA, 1.5V). Be sure the + and - ends of the batteries line up with the markings inside the case.
- 3 Slide the cover back into position.

### Note

- Remove the batteries if not using the remote control for an extended period of time.

## Connecting the antenna or cable

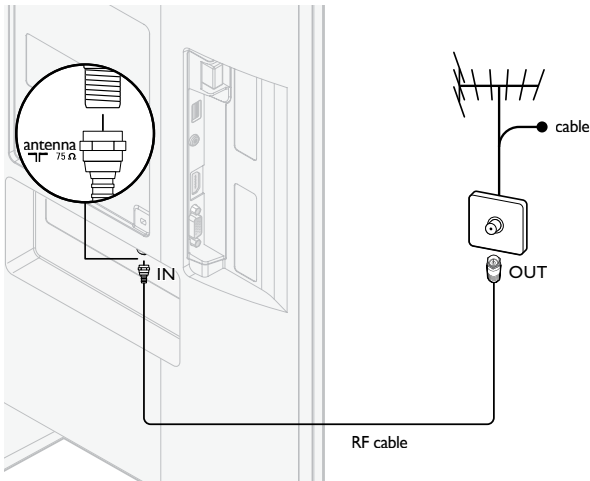

### If you connect to an antenna

Any DTV programs that are broadcast in your area can be received for free through an antenna connection.

Contact your local content provider or your local electronics retailer if you are unsure about what HDTV programs are available in your area.

Broadcasters are transitioning from analog to digital TV. This means that a given broadcaster can have channels available either in analog or in digital, or both analog and digital at the same time.

The TV produces stereo sound only if a stereo signal is broadcast.

### If you connect to a cable

When your TV is connected to the cable socket, you might receive free digital and high definition programs (depending on your cable provider). The channel number for digital and high definition channels includes a dot "•". For example, 11.1, 46.30, 108.201. Contact your cable provider for more information.

### If you connect to a DBS (Direct Broadcast Satellite)

There are two main DBS systems: DirecTV and DishNetwork. These systems require a separate, proprietary set-top box to decode signals and send them to the TV. The set-top box contains a digital TV tuner for receiving off-air digital broadcasts.

Contact your local DBS provider for more information about the connections and the TV channels.

### If you connect to a set-top box

A cable box or satellite set-top box can be connected to the TV through the following connections:

- ANT
- A/V (Composite Video and Audio)
- YPbPr (Component Video Input)
- HDMI

For information about how to connect a set-top box, see the Quick Start Guide provided.

### If you connect a set-top box through RF IN/OUT

If the TV is connected to a cable box or satellite set-top box via a coaxial connection, set the TV to channel 3 or 4, or to the channel specified by the service provider.

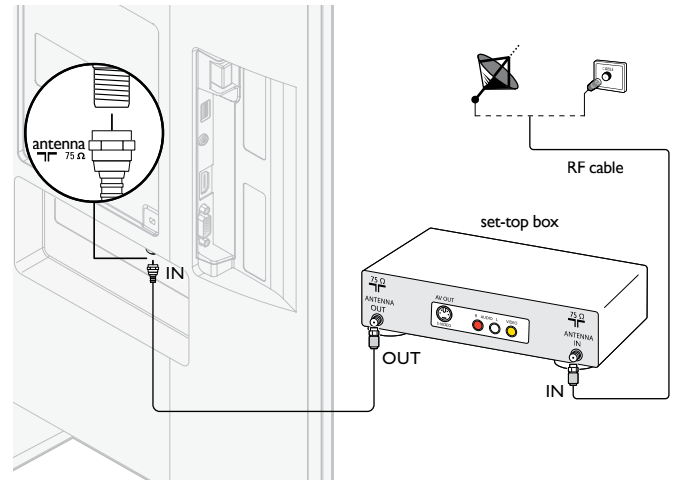

### If you connect a set-top box through HDMI

If the TV is connected to a cable box or satellite set-top box via HDMI, make sure you select the correct HDMI source by using **SOURCE** on this unit's remote control.

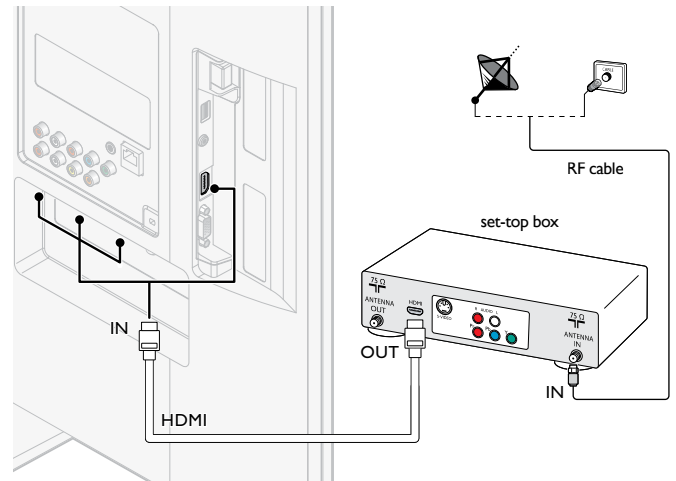

### If you connect a set-top box through component video input

If the TV is connected to a cable box or satellite set-top box via component video input, make sure you select the correct component video source by using **SOURCE** on this unit's remote control.

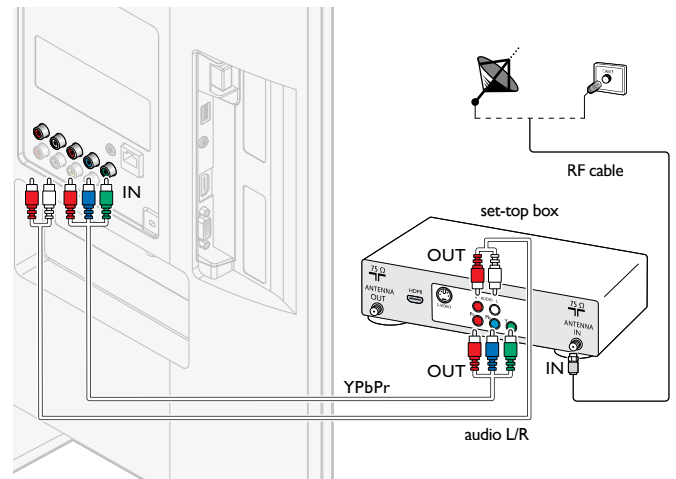

## Managing cables

Route your antenna cable and all other cables through the cable management tie at the back of the TV. The holder helps keep your cables tidy and easily manageable.

- 1 Attach the cable management tie as illustrated below.

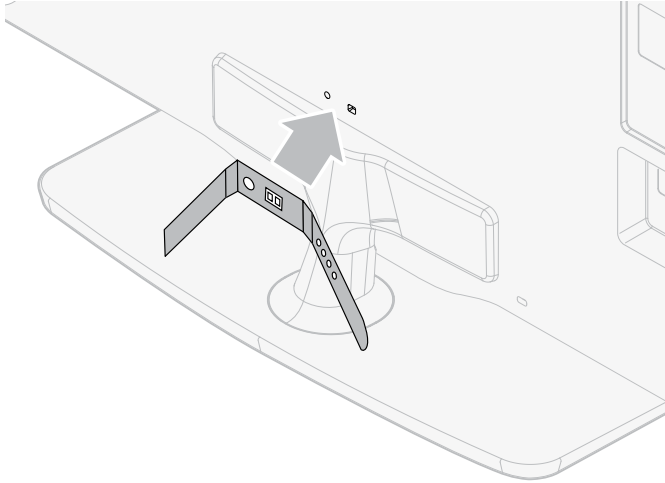

- 2 Pass cables through the cable management tie to avoid tangles.

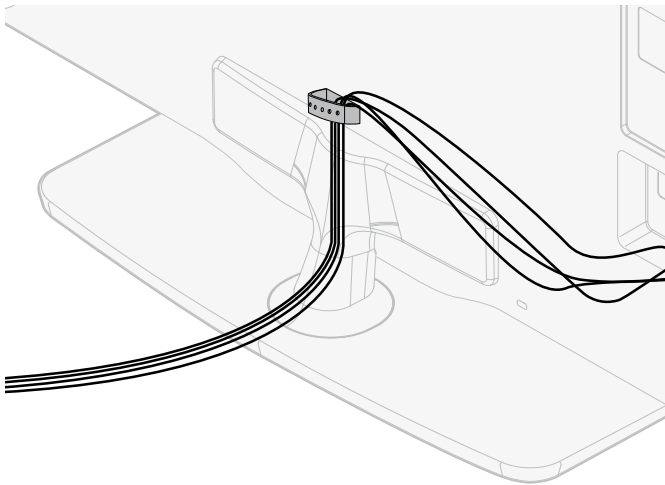

## Connecting the AC power cord

### Warning

- Verify that your power voltage corresponds with the voltage printed at the back of the TV. Do not insert the AC power cord if the voltage is different.

- 1 Locate the power connector at the back of the TV. The location of the power connector varies according to TV model.
- 2 Insert the AC power cord fully into the power connector.
- 3 Connect the AC power cord plug to the power outlet. Ensure that the cord is tightly secured at both ends.

55"

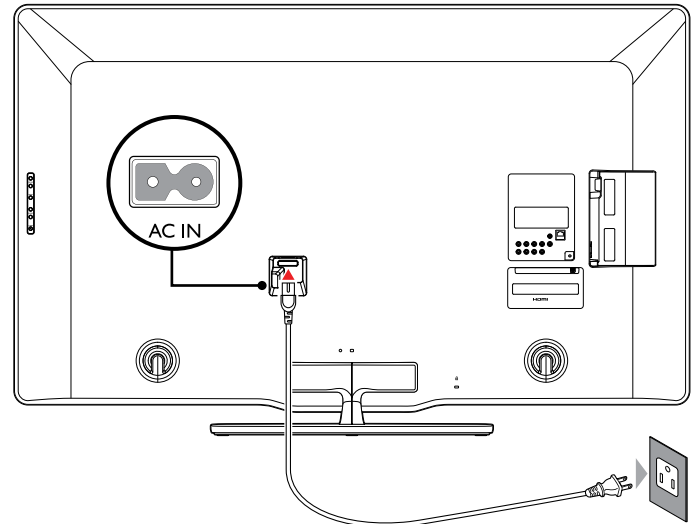

46" / 40"

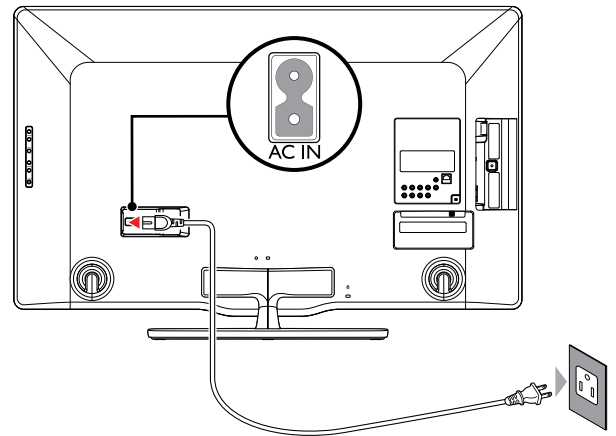

## Disconnect the TV from the power outlet

### Caution

- Pull the AC power cord by the plug; do not pull on the AC power cord.

- 1 Unplug the AC power cord from the power outlet.
- 2 Unplug the AC power cord from the power connector at the back of the TV.

## Switching on and initial setup

Before you switch on the TV, check that the AC power cord is properly connected. Press **POWER** at the right side of the TV, or press **(standby-On)** on the remote control. The TV normally takes 25-30 seconds to start up and the following screen appears the first time you turn on the TV.

After you read a welcome screen, follow the on-screen instructions to select your language and complete your TV setup. Installation takes approximately 20 minutes.



Network setup screen will appear. Use **▲/▼/◀/▶** to select **[Next]** > **[Wireless]/[Wired]**, then press **OK**.

- If you select **[Wireless]**, use **▲/▼** to select a setting and then press **OK**.

Setting items	Description
Easy connect	Select this setting if your router has a Wi-Fi Protected Setup (WPS) button. Start scanning for wireless networks on the TV after pressing the WPS button on your router. If connection test fails, refer to the router's manual for more details.
Scan	Search for wireless networks automatically and select the wireless network name (SSID) from the list. see 'Wireless network setting (Auto)' on page 30.

- If you select **[Wired]**, use **▲/▼** to select a setting and then press **OK**.

Connection test will start automatically. (See 'Connection test' on page 30.)

Press **▲/▼** to select the desired mode for energy saving, then press **OK**.

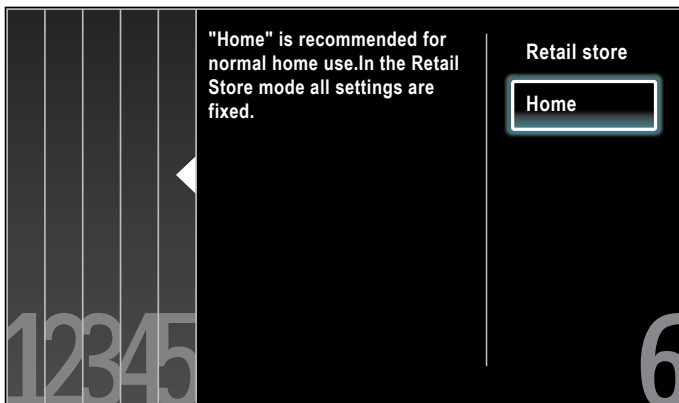

Select **[Retail store]** if you want backlight to be brighter.

Select **[Home]** to reduce power consumption.

You must set **[Home]**. Otherwise, personalized picture and sound settings will not be memorized after the unit goes to standby mode.

- Select **[Retail store]**, the unit will be set up with predefined setting for retail displays. In this setting, the power consumption may possibly exceed the limited requirement of the ENERGY STAR® qualification.
- Select **[Home]**, the unit will be set to maximize energy efficiency. Picture and sound settings can be adjusted and saved as per your personal preferences.

Press **◀/▶** to select **[Start]**, then press **OK** to begin **[Settings assistant]**.

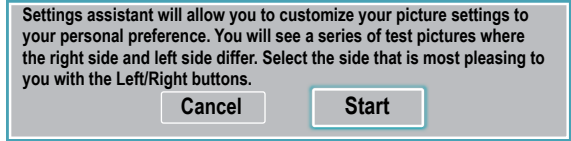

Select **[Picture A]** or **[Picture B]** by pressing **◀/▶** that is the most pleasing to you, then press **OK**. You see 5 different pictures to be completed.

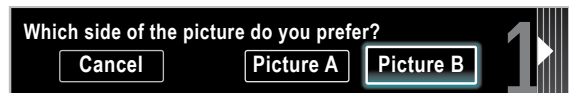

Press **◀/▶** to select **[Store]**, then press **OK**.



Press **OK** to finish **[Settings assistant]**.

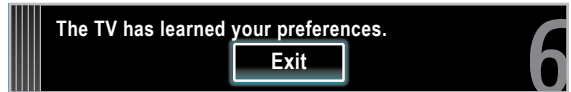

Press **◀/▶** to select **[Finish]**, then press **OK**.

Finish the Setup.

### Note

- If you are not receiving a signal from your cable service, contact the CATV provider.
- If you press **(standby-On)** during autoprogram, an installation will be canceled except the language selection.
- The initial autoprogram function can be executed for either **[Antenna]** or **[Cable]** only once. When you change the connection (Antenna/Cable), set autoprogram again. (Refer to page 35.)

# 5 Use your TV

This section helps you perform basic TV operations.

## Switching on your TV and putting it in standby mode

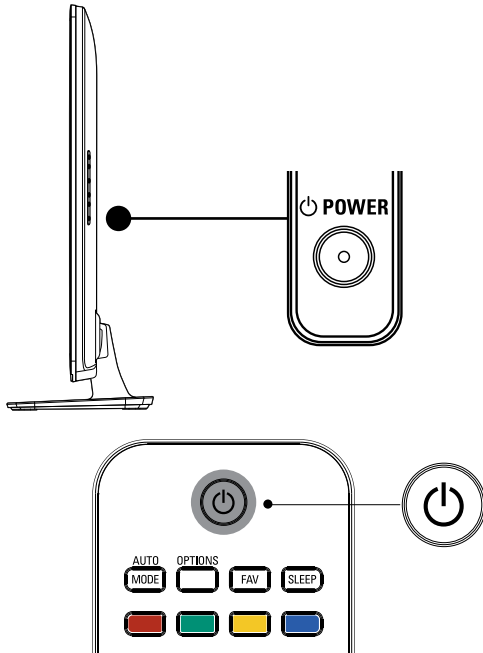

### To switch on

- Press **POWER** at the side of the TV or press **POWER** (standby-On) on the remote control.

### To switch to standby

- Press **POWER** at the side of the TV or press **POWER** (standby-On) on the remote control again.

### Note

- Energy consumption contributes to air and water pollution. When the AC power cord is plugged in, your TV consumes energy. Your TV has very low standby power consumption.

## Switching channels

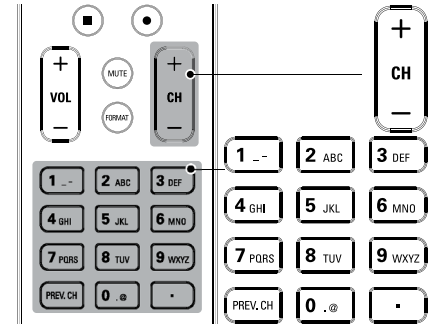
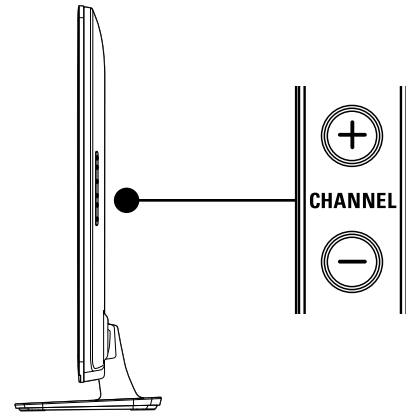

Press **CHANNEL +/-** on the side of the TV.

- Press **CH +/-** or enter a number on the remote control. For digital channels, press a number (1 to 999) followed by a dot "." and then the corresponding sub channel number (1 to 999). e.g. 108.30.
- Press **PREV. CH** to return to the previously viewed channel.

## Adjusting volume

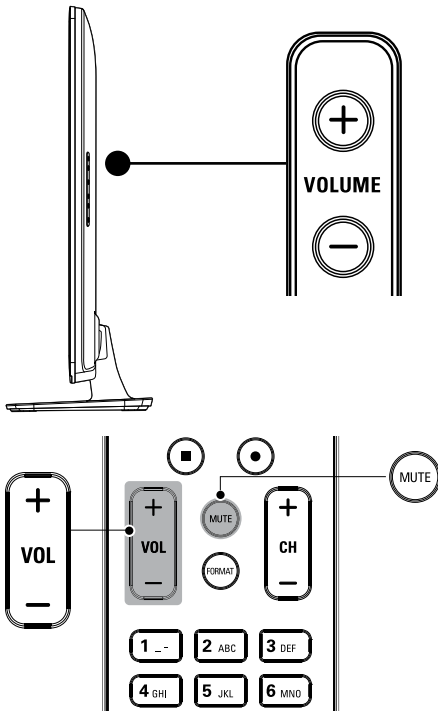

### To increase or decrease volume

- Press **VOL +/-** on the remote control or press **VOLUME +/-** on the side of the TV.

### To mute or unmute sound

- Press **MUTE** on the remote control to mute the sound.
- Press **MUTE** again or **VOL +/-** to recover the original sound.

## Watching channels from a set-top box

### To watch channels from a set-top box

- 1 Switch on the set-top box.
  - ↳ The picture from your set-top box might appear automatically on the TV screen.
- 2 Use the remote control of your set-top box to select channels.

### If the picture does not appear

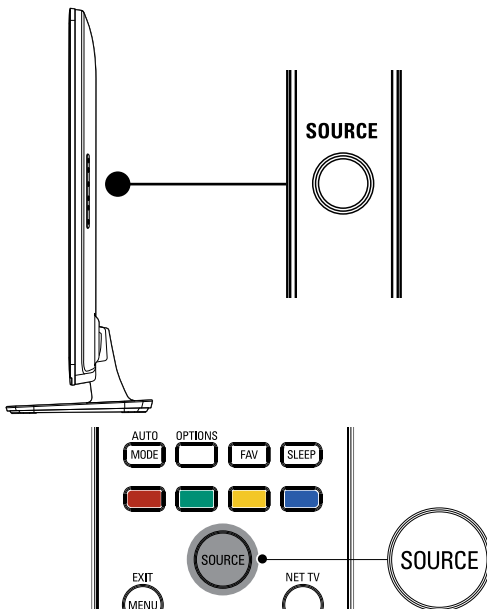

- 1 Press **SOURCE** repeatedly to select the set-top box and wait a few seconds for the picture to appear.
- 2 Use the remote control of your set-top box to select channels.

## Watching connected devices

### To watch connected devices

- 1 Switch on the connected device.
  - ↳ The picture from your connected device might appear automatically on the TV screen.
- 2 Use the remote control of the device to select channels.

### If the picture does not appear

- 1 Press **SOURCE** repeatedly to select the connected device and wait a few seconds for the picture to appear.
- 2 Use the remote control of the device to select channels.

### Automatic Power Shut Off

If there is no input signal and no operation for 15 minutes, the unit will turn off automatically.

## Watching a Blu-ray disc

### To watch a Blu-ray Disc

- 1 Insert a Blu-ray Disc into your player.
- 2 Press **▶ (play)** on the remote control of the Blu-ray Disc player.
  - ↳ The Blu-ray Disc might automatically play on the TV.

### If the picture does not appear

- 1 Press **SOURCE** repeatedly to select the Blu-ray Disc player and wait a few seconds for the picture to appear.
- 2 Use the remote control of the Blu-ray Disc player to play the disc.

# 6 Use more of your TV

## Access TV menus

Menus help you to install channels, change picture and sound settings then access other features.

### Access the home menu

The home menu gives you easy access to connected devices, picture and sound settings as well as other useful features.

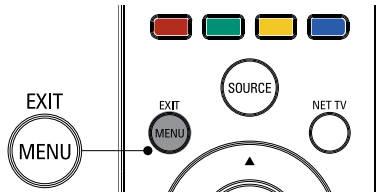

- 1 Press **MENU** on the remote control.

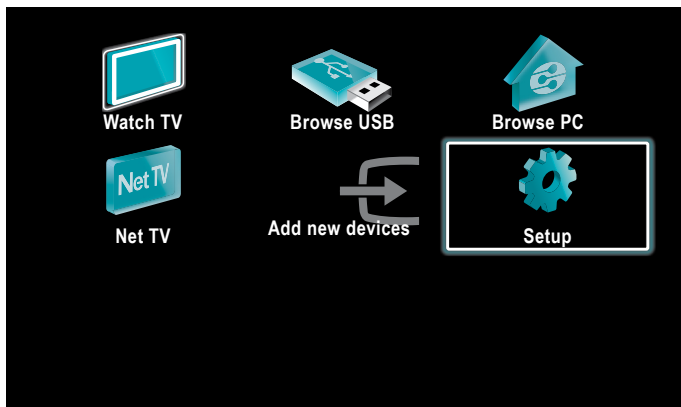

- 2 Use **▲/▼/◀/▶** to select and navigate through one of the following menus.
  - **[Watch TV]** Switches back to the antenna source if another source is selected.
  - **[Browse USB]** Accesses USB menus.
  - **[Browse PC]** Accesses DLNA menus.
  - **[Net TV]** Accesses Net TV menus.
  - **[Add new devices]** Adds new devices to the home menu.
  - **[Setup]** Accesses menus that allow you to change picture, sound and other TV settings.
- 3 Press **OK** to confirm your choice.
- 4 Press **MENU** to exit.

#### Tip

- After selecting **[Add new devices]**, follow the on-screen instructions to select the correct device and connector.

## Lock or unlock your device from the home menu

This section describes how to lock or unlock specified device.

- 1 Press **MENU** on the remote control.
- 2 Use **▲/▼/◀/▶** to select a device to lock or unlock.
- 3 Press **OPTIONS** on the remote control.
- 4 Use **▲/▼** to select **[Device lock]** or **[Device unlock]**, then press **OK**.
  - If device lock is unlocked, **[Device lock]** will be displayed. If device lock is locked, **[Device unlock]** will be displayed.
  - When device lock is locked,  will be displayed at the top right of the device icons.
- 5 Enter your PIN. (See 'Setting your PIN' on page 26.)
  - Once you have set PIN, PIN input menu does not appear after the unit is turned on.

## Enable or disable RC key forwarding from the home menu

This section describes how to enable or disable RC key forwarding for a particular device.

- 1 Press **MENU** on the remote control.
- 2 Use **▲/▼/◀/▶** to select a device to enable or disable RC key forwarding.
- 3 Press **OPTIONS** on the remote control.
- 4 Use **▲/▼** to select **[Enable RC key forwarding]** or **[Disable RC key forwarding]**, then press **OK**.
  - If RC key forwarding is set to off, **[Enable RC key forwarding]** will be displayed. If RC key forwarding is set to on, **[Disable RC key forwarding]** will be displayed.
  - When you set RC key forwarding on,  will be displayed at the top left of the device icons.

#### Note

- This function is available only when your devices are connected to this unit through HDMI cables and assigned to an HDMI port (HDMI1 to HDMI4) with **[Add new devices]** in the home menu.

## Philips Wireless MediaConnect

You can enjoy your TV as a PC monitor wirelessly using your home network. Make sure you download the Philips Wireless MediaConnect software and install it on your PC before you perform the steps below.

### Install Philips Wireless MediaConnect

- 1 Press **MENU** on the remote control and then use **▲/▼/◀/▶** to select **[Setup] > [Software] > [MediaConnect code]**.
  - Write down the 12-digit code displayed on the screen. You will need this to download MediaConnect software.
- 2 Start your internet browser on your PC and open the Philips Wireless MediaConnect download page at [www.wifimediconnect.philips.com/](http://www.wifimediconnect.philips.com/). On the website, you can check the necessary PC system requirements.
- 3 Enter the 12 digit code you wrote at step 1.
- 4 Click the 'Download now' button to download the free Philips Wireless MediaConnect software.
- 5 Once downloaded, start the file "Philips Wireless MediaConnect\_setup.exe". Follow the instructions on the screen to complete software installation.

### Using Philips Wireless MediaConnect

- 1 Launch Philips Wireless MediaConnect on your PC first.
  - Select "Start projecting" with right click on the  in the system tray.
  - The start up screen for Philips Wireless MediaConnect will be displayed and the unit searches for an available PC that is running Philips Wireless MediaConnect software.

Once connected, the Philips Wireless MediaConnect software will encode and stream the screen of your PC as a video along with audio.

Depending on your computer and network configuration, there will be a delay between your PC screen and the TV but the audio-video will always be in sync.

### Philips Wireless MediaConnect Help

To read the Philips Wireless MediaConnect Help, right click the program icon in the notification tray of the PC and select Help.

### Specifics

You can project high definition (HD) or standard definition (SD) video, depending on the processing power of your PC. For smooth playback of HD video, please use a hardware accelerated video player on your computer. A hardware accelerated video player uses the graphics adapter of your PC to render HD video rather than the processor. This frees up the processor for Philips Wireless MediaConnect video encoding. The content protection on most DVD or Blu-ray Disc movies might restrict watching the movie on TV when the disc is playing on a PC. The TV shows PC media files with a small delay. Philips Wireless MediaConnect is only available for PC.

### PC requirements

Windows XP, Windows Vista, Windows 7 (PC only)

#### Minimum PC requirements

- Intel Core 2 Duo 1.8GHz
- 512MB RAM
- IEEE 802.11g

#### Recommended PC requirements

- Intel Core 2 Duo 2.1GHz
- 1GB RAM

## View photos, play music and watch videos using DLNA

On your TV you can play video, music and photo files stored on DLNA certified home media servers connected to your home network. In order to use this feature, you must connect this unit to the Internet.

**It is recommended that files to be played back in this unit are recorded under the following specifications:**

<b>&lt;MP3&gt;</b>	
• Sampling frequency	: 32kHz or 44.1kHz or 48kHz
• Constant bit rate	: 32kbps - 320kbps
<b>&lt;JPEG&gt;</b>	
• Upper limit	: 16Mpixel
<b>&lt;MPEG&gt;</b>	
• Playable codec	: MPEG1, MPEG2
• Maximum size of a video	: 1920x1080
• Audio type	: AC3, MPEG1 audio layer 3 (MP3), MPEG1 audio layer 2, LPCM

### Note

- A maximum of 1,023 folders or files can be recognized.
- For the home server list, maximum of 16 servers can be displayed.
- The 10th and deeper hierarchies cannot be displayed.
- Unplayable files in the home server will not be displayed in the file list.
- For some files, playback is not available even if displayed in the file list.
- In order to play back the contents in home servers, the player and the servers must be connected to the same access point.
- Compatibility and available playback function may differ depending on the home server.
- Video files with unsupported audio format will be skipped.
- The quality of the playback picture or audio differs depending on your network condition.

### Before using DLNA

Follow the following procedure before using DLNA.

- 1 Connect this unit to the internet. (See 'Connecting the TV to the internet using an Ethernet cable' or 'Connecting the TV to the internet using a wireless LAN' on page 41.)
  - Broadband internet connection of 8Mbps or faster is required.
- 2 Set up the necessary network connection settings. (See 'Network' on page 30.)

### Using DLNA

- 1 Start DLNA home media servers in your home network.
  - For details, refer to the user manual of the DLNA certified device.
- 2 Press **MENU** on the remote control.
- 3 Use **▲/▼/◀/▶** to select **[Browse PC]**.
  - This unit will start loading the home server list.
- 4 After loading, home server list will appear. Select a home server you want to access, then press **[OK]**.



## Guide to DLNA

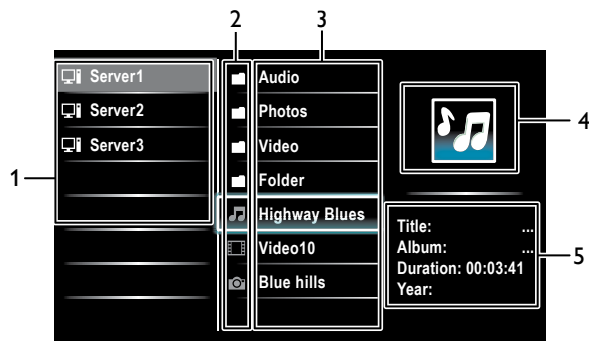

- 1 Home server list
- 2 Folder/media icon
- 3 Group (folder)/file list
- 4 Image
- 5 Current file info

## View your pictures using DLNA

- 1 Press ▲/▼ to select a file or a folder.
- 2 Press OK or ►|| to start a slideshow of the files.
  - Press OK or ►|| to pause the slide show.
    - ↳ The || icon appears.
  - Press ◀◀ or ▶▶ to move between images.
  - Press BACK or ■ to stop the slide show.
  - Press OPTIONS to display the optional menu, then use ▲/▼ to select the desired item.

Setting items	Description	
Slide time * <sup>1</sup>	Short	Switches to the next image in 5 seconds.
	Medium	Switches to the next image in 10 seconds.
	Long	Switches to the next image in 15 seconds.
Transitions * <sup>1</sup>	None	No effect when switching images.
	Dissolve	Overlaps a next image on a current image.
	Wipe right	Pushes a current image out from left.
	Wipe left	Pushes a current image out from right.
	Wipe up	Pushes a current image out from bottom.
	Wipe down	Pushes a current image out from top.
	Box in	A next image comes into the center from out.
	Box out	A next image goes to the out from center.
	Rotate * <sup>2</sup>	0
90		Rotates an image clockwise by 90 degrees.
180		Rotates an image clockwise 180 degrees.
270		Rotates an image clockwise 270 degrees.
Zoom * <sup>2</sup>	1x	Displays an image at its original size.
	2x	Magnifies a current image as twice.
	4x	Magnifies a current image as fourfold.

\*<sup>1</sup>You can set [Slide time] and [Transitions] when images are in Slide show.

\*<sup>2</sup>You can set [Rotate] and [Zoom] when Slide show is in pause mode.

## Listen to music using DLNA

- 1 Press ▲/▼ to select a file or a folder.
- 2 Press OK or ►|| to play the selected files.
  - Press OK or ►|| to pause, press OK or ►|| again to resume.
  - Press ▶▶ to skip up the next file.
  - Press ◀◀ to skip down the previous file.
  - Press ■ to stop playback.
  - Press OPTIONS to display the optional menu, then use ▲/▼ to select the desired item.

Setting items	Description	
Repeat	Off	Sets repeat playback to off.
	On	Sets repeat playback for all MP3 files in the current folder.
Shuffle	Off	Sets shuffle playback to off.
	On	Sets shuffle playback for all MP3 files in the current folder.
TV speakers	Off	The sound will not be output from the unit's speakers.
	On	The sound will be output from the unit's speakers.
	Speakers EasyLink	You can control audio output from your connected EasyLink Compliant Devices with VOL +/- by using this unit's remote control.

### Note

- [Master EasyLink] must be activated in the [Preferences] menu to make the [TV Speakers] menu available when you select [On] or [Speakers EasyLink].

## Watch videos using DLNA

- 1 Press ▲/▼ to select a file or a folder.
- 2 Press OK or ►|| to play the selected files.
  - Press OK or ►|| to pause, press OK or ►|| again to resume.
  - Press ▶▶ to fast-forward search.
  - Press ◀◀ to fast-backward search.
  - Press ■ to stop playback.
    - ↳ Press ►|| to resume from the point at which playback was stopped. Press OK to play from the beginning of the file at which playback was stopped.
  - Press CH + to play the next file.
  - Press CH - to play the current file at the beginning.
    - ↳ Press CH - twice within 5 seconds to play the previous file.
  - Press OPTIONS to display the optional menu, then use ▲/▼ to select the desired item.

Setting items	Description	
TV speakers	Off	The sound will not be output from the unit's speakers.
	On	The sound will be output from the unit's speakers.
	Speakers EasyLink	You can control audio output from your connected EasyLink Compliant Devices with VOL +/- by using this unit's remote control.

### Note

- The resume information will be kept even when the unit is turned off.
- If you play another file while the previously viewed file is being resumed, the resume information of the previously viewed file will be deleted.

## Net TV

Net TV offers Internet services for your TV. Use the TV remote control to browse the Net TV Internet pages. You can play movies, listen to music and much more, all from your TV screen.

- Because Net TV is an online system, it can be modified over time to better serve its purpose.
- Some Net TV services can be added, changed or stopped after some time.
- You cannot download and save files or install plug-ins.

### Before Logging in to Net TV

Follow the procedure below before logging in to Net TV.

- 1 Connect this unit to the internet.  
(See 'Connecting the TV to the internet using an Ethernet cable' or 'Connecting the TV to the internet using a wireless LAN' on page 41.)
- 2 Set up the necessary network connection settings.  
(See 'Network' on page 30.)

### Logging in to Net TV

- 1 Press **NET TV** on the remote control.
  - Net TV screen will appear.
  - For the first time only, [Philips Terms of Use Internet Enabled product] screen will appear. After confirming the content, use ◀/▶ to select [Agree], then press **OK**.

### Guide to Net TV menu screen

#### Net TV start screen

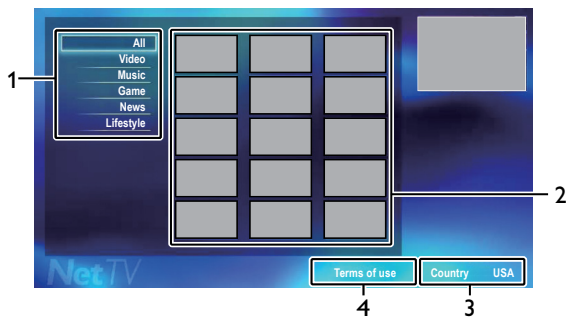

- 1 Sorting items : Categorizes genre of each services.
- 2 Network Service icons : Displays service icons.
- 3 Country : Selects what country you live.
- 4 Terms of Use : Displays a clause of net service.

### Information on Network Services

For detailed information on 3rd party Internet services, please visit the service providers website:

Netflix	: <a href="http://www.netflix.com/HowItWorks">http://www.netflix.com/HowItWorks</a>
Film Fresh	: <a href="http://filmfresh.roxionow.com/">http://filmfresh.roxionow.com/</a>
Blockbuster	: <a href="http://www.blockbuster.com">http://www.blockbuster.com</a>
VUDU	: <a href="http://www.vudu.com/product_overview.html">http://www.vudu.com/product_overview.html</a>
Cloud TV	: <a href="http://www.activevideo.com">http://www.activevideo.com</a>

## Enjoying vTuner

With this unit, you can enjoy video and internet radio with vTuner via the internet. In order to watching video and listen to internet radio, you must connect this unit to the internet.

### Video playback

After you set up the network connection, follow the following procedure to watch the video.

#### Guide to the player screen

e.g.) Recommendations

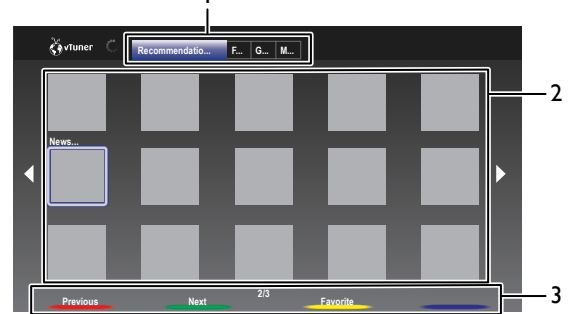

- 1 Category : List of category menus  
[Recommendations]  
List of recommendation stations  
[Favorites]  
List of your favorite video stations  
[Genre]  
List of stations categorized by genre  
[Most Popular Podcasts]  
List of popular podcasts
- 2 Station list : Displays station list.
- 3 Operation guide : Displays color buttons (red/green/yellow/blue) guide.

- 1 Press **NET TV** on the remote control and then use ▲/▼/◀/▶ to select [vTuner Video].
- 2 Use ◀/▶ to select the desired category, then press **OK**.
- 3 In the player screen, use ▲/▼/◀/▶ to select the desired station or genre, then press **OK**.

#### Guide to the playback screen



- 1 Station icon
  - 2 Station name
  - 3 Station information
  - 4 Episode list
  - 5 Color buttons (red/green/yellow/blue) guide
  - 6 Current episode information
- 4 In the playback screen, use ▲/▼ to select the desired episode, then press **OK**.
    - After loading, playback of the selected episode will start.
    - To stop playback, press ■.
    - Episode list can be displayed 5 episodes at one time. To show the previous/next episodes, press **Color buttons (red/green)**.
    - To enlarge playback screen, press **Color buttons (blue)**.

5 Press **MENU** to exit.

### Note

- Video service may not be fully available with narrowband internet connection. (e.g. 56k modem) When watching video, use broadband internet connection. (For details, contact your internet service provider.)
- Depending on the bit rate of a station or the network environment, it may take a while to complete loading the station or playback may not be available.
- The streaming video may be interrupted during playback, when the vTuner server is busy.
- Some stations cannot be displayed in the list, depending on the network environment.
- If the loading time of a station exceeds 3 minutes, the loading will be canceled.
- The order of station/episode in the list depends on the information from vTuner server and may change without notice.

## Add to Favorites

You can add your favorite stations to **[Favorites]** in the category tab. To add your favorite stations, follow the following procedure.

- 1 Follow steps 1 to 2 in 'Video playback' on page 17.
- 2 Use **▲/▼/◀/▶** to select the station you want to add to **[Favorites]**, then press **Color buttons (yellow)**.
  - The selected station is added to the station list in **[Favorites]**.
  - Confirmation message will appear.
  - Press **Color buttons (yellow)** to add your favorite station in **[Favorites]** while the desired episode is selected in the episode list or the episode is being played back.
- 3 Press **OK**.
- 4 Press **MENU** to exit.

## Remove from Favorites

- 1 Follow step 1 in 'Video playback' on page 17.
- 2 Use **◀/▶** to select **[Favorites]** in the category tab, then press **OK**.
- 3 Use **▲/▼/◀/▶** to select the station you want to remove from **[Favorites]**, then press **Color buttons (yellow)**.
  - Confirmation message will appear.
- 4 Use **◀/▶** to select **[Yes]**, then press **OK**.
  - The selected station is removed from **[Favorites]**.
- 5 Press **MENU** to exit.

## Internet radio playback

After you set up the network connection, follow the following procedure to listen to internet radio.

- 1 Press **NET TV** on the remote control and then use **▲/▼/◀/▶** to select **[vTuner Radio]**.
  - Category list will appear.
- 2 In the category list, use **▲/▼** to select the desired category, then press **OK**.
  - Station/folder list of selected category will appear.
  - For **[Location]** and **[Genre]**, use **▲/▼** to select the desired location or genre after selecting the category, then press **OK**.

### **[Recently Played]**

List of stations which are recently played

### **[Favorites]**

List of your favorite radio stations

### **[My Added Stations]**

List of stations which are added on vTuner website (This category will appear only after you add stations on vTuner website.)

### **[Location]**

List of stations categorized by location

### **[Genre]**

List of stations categorized by genre

### **[New Stations]**

List of new stations

### **[Most Popular Stations]**

List of popular station

### **[Get access code]**

Displays the access code, which will be required when creating a vTuner account on your PC

### **[Reset]**

Removes all stations/folders in **[Recently Played]**, **[Favorites]** and **[My Added Stations]**

3 In the station/folder list, use **▲/▼** to select the desired station, then press **OK**.

- After loading, playback of the selected station will start.
- If you select a folder; use **▲/▼** to select the desired station in the next hierarchy, then press **OK**.
- To stop playback, press **■**.
- To go back to the previous or next hierarchy, press **◀/▶**.

4 Press **MENU** to exit.

### Note

- This unit cannot play back stations with audio format other than MP3 and WMA.
- Internet radio service may not be fully available with narrowband internet connection. (e.g. 56k modem) When listening to internet radio, use broadband internet connection. (For details, contact your internet service provider.)
- Depending on the bit rate of a station or the network environment, it may take a while to complete loading the station or playback may not be available.
- The streaming audio may be interrupted during playback, when the vTuner server is busy.
- Some stations cannot be displayed in the list, depending on the network environment.
- If the loading time of a station exceeds 3 minutes, the loading will be canceled.
- The order of station/folder in the list depends on the information from vTuner server and may change without notice.

## Guide to the playback screen

e.g.) Location

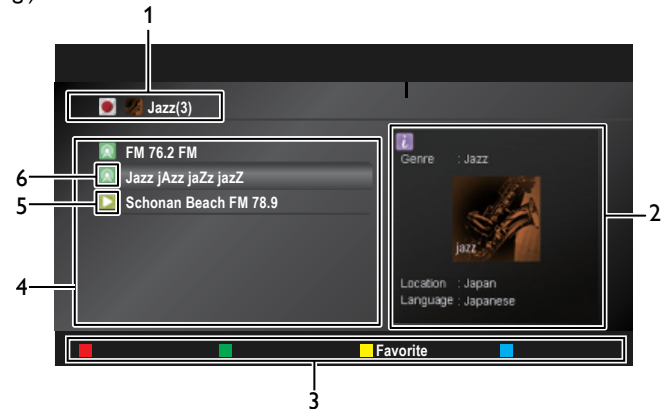

- 1 Current hierarchy (total number of items)
- 2 Current station information (Information will be changed when **INFO** is pressed)
- 3 Color buttons (red/green/yellow/blue) guide
- 4 Station list
- 5 Playback status
- 6 Station icon

## Add to favorite list

You can add your favorite stations to **[Favorites]** in the category list. To add your favorite stations, follow the following procedure.

- Follow steps **1** to **3** in 'Internet radio playback' on page 18.
- Use **▲/▼** to select the station you want to add to **[Favorites]**, then press **Color buttons (yellow)**.
  - The selected station is added to **[Favorites]** folder.
  - Confirmation message will appear.
  - If you select a folder, use **▲/▼** to select the desired station in the next hierarchy, then press **Color buttons (yellow)**.
- Press **OK**.
- Press **MENU** to exit.

### Note

- You can also add your favorite stations to **[Favorites]** on your PC. To add your favorite stations on your PC, visit <http://go2service.vtuner.com/ph/> and create a vTuner account with the access code, which you can check from the category list. (See 'Internet radio playback' on page 18.)
- You can change folder names or order of lists in your vTuner page on the internet.
- [My\_Favorite]** folder will appear after you add a station to **[Favorites]** on this unit. (Your favorite station will also be added to **[My\_Favorite]** folder.)

## Remove from favorite list

- Follow steps **1** to **2** in 'Internet radio playback' on page 18.
- Use **▲/▼** to select **[Favorites]**, then press **OK**.
- Use **▲/▼** to select the station you want to remove from **[Favorites]**, then press **Color buttons (yellow)**.
  - Confirmation message will appear.
- Use **◀/▶** to select **[Yes]**, then press **OK**.
  - The selected station is removed from **[Favorites]** folder.
- Press **MENU** to exit.

## Add stations on the vTuner website

You can add stations which are not in the vTuner station list.

- Follow steps **1** to **2** in 'Internet radio playback' on page 18.
- Use **▲/▼** to select **[Get access code]**, then press **OK**.
  - The latest vTuner website address and access code for this unit will be displayed. Please take a note of the access code. (This access code will be required when creating a vTuner account.)
- On your PC, visit the website and create your vTuner account.
  - Follow the instructions given on the PC screen.
- Add stations by following the instructions given on the PC screen.
  - The stations will be added to **[My Added Stations]**.

## Reset the station list

You can remove all stations/folders in **[Recently Played]**, **[Favorites]** and **[My Added Stations]**.

- Follow steps **1** to **2** in 'Internet radio playback' on page 18.
- Use **▲/▼** to select **[Reset]**, then press **OK**.
- Use **▲/▼** to select **[Yes]**, then press **OK**.
  - All stations/folders in **[Recently Played]**, **[Favorites]** and **[My Added Stations]** are removed.
- Press **MENU** to exit.

## Pandora operations

With this unit, You can instantly listen to personalized radio stations streamed over the Internet from Pandora.

To learn more about Pandora, please visit [www.pandora.com](http://www.pandora.com)

### Activating Pandora

In order to listen to Internet radio streamed from Pandora via the Internet, you must create a Pandora account and activate this unit.

- Press **NET TV** on the remote control and then use **▲/▼/◀/▶** to select **[PANDORA] > [Create new account]**.
- Use **▲/▼** to select **[No, I am new to Pandora.]**, then press **OK**.
- Note the activation code and website address displayed on the TV screen.
- On your PC, visit the website address noted at step **3**.
- Follow directions on the website to create your account.
- On this unit, select **[Continue]** and press **OK** to complete activation.

### Adding Pandora User Accounts

You can add multiple Pandora user accounts on this unit.

- Follow steps **1** to **2** in 'Activating Pandora' on page 19.
- Use **▲/▼** to select **[Yes, I have a Pandora account]**, then press **OK**.
- Enter your e-mail address, then press **OK** while **[OK]** is selected.
- Enter a password, then press **OK** while **[OK]** is selected.
- Use **▲/▼** to select **[Sign In]**, then press **OK**.
  - Your account is added to the user list and player screen appears on the TV screen.

### Note

- Pandora is available only in the United States.
- You can add up to 5 accounts. After creating 5 accounts, **[Create new account]** is not displayed.

### Creating a New Station

By entering your favorite artists or songs, Pandora selects music and creates a new station for you on the basis of the entered information.

- On the player screen, press **Color buttons (blue)** to display station list.
- Press **Color buttons (yellow)** to call up the **[Tool Menu]**.
- Use **▲/▼** to select **[Create a new station]**, then press **OK**.
- Enter a name of your favorite artist or song, then press **OK** while **[OK]** is selected.
  - Search result will appear on the right side of the TV screen.
  - If the selection screen of result type appears, use **▲/▼** to select the desired type, then press **OK**.
- Use **▲/▼** to select the desired station, then press **OK** to start the playback.

Button	Action
▶	Resume the playback/Pause the playback.
■	Stop the playback and the station list will appear.
▶▶	Skips to the next song.





### Note

- On the **[Tool Menu]**, you can delete or rename the currently selected station.

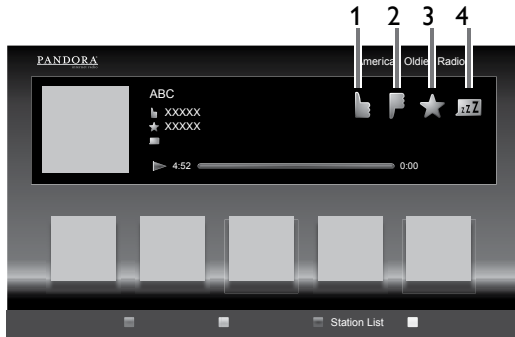
## Guide to the Player Screen

On the player screen, you can set various options to the currently playing song.



- 1  Give thumbs up to the currently playing song. Pandora will play songs similar to the song.
- 2  Give thumbs down to the currently playing song. Pandora will skip and will not play the song.
- 3  Bookmarks the currently playing song. You can view your bookmarked songs list by accessing Pandora website and log into your account.
- 4  Tells Pandora that you do not like the currently playing song. Pandora will not play the song for about a month.

## Using Twitter

You can view your Twitter feeds and more using the Twitter application on this unit.

- For more details about Twitter, please visit [www.twitter.com](http://www.twitter.com)

### Logging in to Twitter

After you set up the network connection, you must log in with your Twitter account.

Make sure the unit is not in network service or Browse USB mode.

- 1 Press **NET TV** on the remote control and then use **▲/▼/◀/▶** to select **[Twitter]**.
  - Login screen will appear.
- 2 Use **▲/▼** to select **[Username]**, then press **OK**.
  - Software keyboard will appear.

Keys on the keyboard	Action
<b>Characters</b>	Select each one of characters from the list.
<b>Clear</b>	Delete the last character in the entry field.
<b>All clear</b>	Delete all characters in the entry field.
<b>a/A/@</b>	Switch case and symbols.
<b>Cancel</b>	Cancel the input.
<b>OK</b>	Determine the input Username and/or Password.

- 3 Use **▲/▼/◀/▶** to input your **[Username]** and **[Password]** into the entry fields. Select **[OK]** after you have filled in all the necessary items in the entry field, then press **OK**.
  - Password can be skipped next time onwards once you have selected **[Remember me]** when registering the user name.
  - Software keyboard will disappear.
- 4 Use **▲/▼/◀/▶** to select **[Start]**, then press **OK**.
  - The unit will now establish a connection with the Twitter server and perform authentication.
- 5 When the unit is logged in successfully, Twitter **[Home]** menu will appear at the left and the timeline will appear at the bottom of the TV screen.

#### Note

- User name and password are case-sensitive.
- User name will not accept your e-mail account. Use only your user name registered on the Twitter server.
- If you select **[Start]** with no user name, the unit logs in as 'Public'. In this case you can display 'Public timeline' and 'Trends' only.
- For questions regarding Twitter, please visit [www.twitter.com](http://www.twitter.com)

## Guide to Twitter menu screen

### Twitter Home Screen

Twitter Home Screen consolidates browsing of tweets and some functional menus for Twitter.

To call up the screen, press **NET TV** on the remote control and then use **▲/▼/◀/▶** to select **[Twitter]**.

#### Single View



- |                   |   |
|-------------------|---|
| 1 Menu            | : List of functional menus.                             |
| 2 Viewing channel | : Displays currently watching channel.                  |
| 3 Timeline        | : Displays currently tweeting on Twitter.               |
| 4 Operation guide | : Displays Color buttons (red/green/yellow/blue) guide. |

#### Full View

Single view switches to Full view when you select timeline then press **OK**.

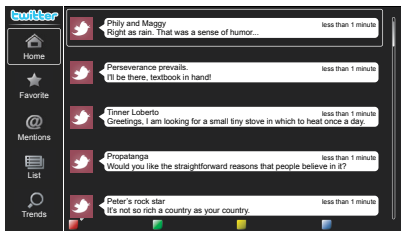

## Displaying Mentions on Twitter

YourTV displays replies for the logged in user:

- Follow steps **1** to **2** in 'Viewing tweets on the TV' on page 21.
- Use **▲/▼** to select **[Mentions]**, then press **OK**.
  - If you have no replies, **[TV was not able to acquire the Tweet.]** will appear.

## Viewing Lists on Twitter

The list shows timeline categories such as friends, family, colleagues, or sports teams created by yourself on your account.

- Follow steps **1** to **2** in 'Viewing tweets on the TV' on page 21.
- Use **▲/▼** to select **[List]**, then press **OK**.
  - If you have no lists, **[Cannot get the list information.]** will appear.
- When you press **Color buttons (yellow)** in 1 or 5 list view, the timeline will be separated at top and bottom. The upside displays 3 timelines and the downside display 2 timelines.

#### 2 List View

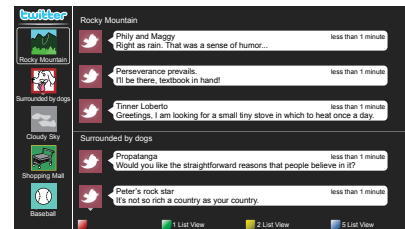

- When you press **Color buttons (blue)** in 1 or 2 list view, the timeline will increase 5 lines.

#### 5 List View



## Viewing tweets on the TV

After logging in to Twitter, yourTV will download the latest 20 tweets to display.

- Press **NET TV** on the remote control and then use **▲/▼/◀/▶** to select **[Twitter]**.
- Use **▲/▼/◀/▶** to select the desired user name, then press **OK**.
  - If you have not stored the password, **[COTV]** will appear beside the user name.
- When the unit is logged in successfully, Twitter **[Home]** menu will appear at the left and the timeline will appear at the bottom of the TV screen.

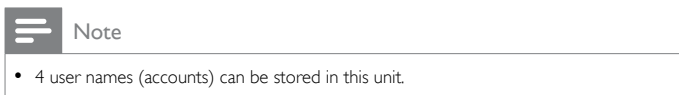

## Viewing Favorites on Twitter

YourTV displays the logged in user's favorites on Twitter:

- Follow steps **1** to **2** in 'Viewing tweets on the TV' on page 21.
- Use **▲/▼** to select **[Favorite]**, then press **OK**.
  - If you have no favorites, **[TV was not able to acquire the Tweet.]** will appear.

## Viewing Trends on Twitter

Trends show topics trending in your area.

- Follow steps **1** to **2** in 'Viewing tweets on the TV' on page 21.
- Use **▲/▼** to select **[Trends]**, then press **OK**.
  - Press **Color buttons (green)** to switch between the **[Area]** and **[Trends]**.
  - If you display **[Area]**, the topside will be displayed some countries, and the downside will be displayed some cities.

# Changing picture and sound settings

You must set **[Home]** in **[Location]**. (Refer to page 30.)  
 Otherwise, personalized picture and sound settings will not be memorized after the unit goes to standby mode.

## Changing picture settings

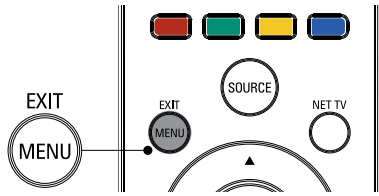

- 1 Press **MENU** on the remote control.
- 2 Use **▲/▼/◀/▶** to select **[Setup] > [Picture]**.

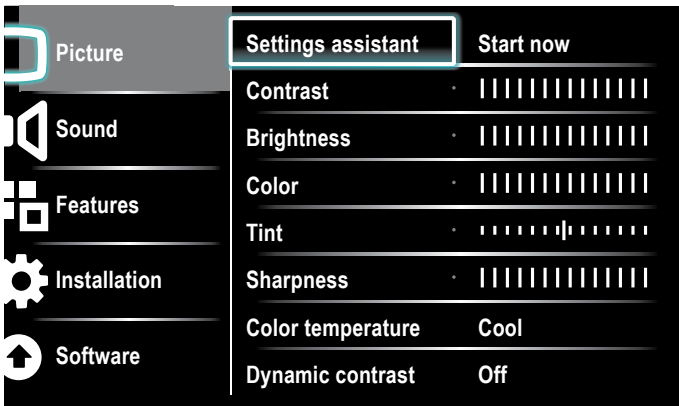

- 3 Use **▲/▼/◀/▶** to select one of the picture settings, and press **OK** to enter the setting.
- 4 Adjust the picture quality.  
 The following picture settings can be configured. Depending on the format of the picture source, some picture settings are not available.

Setting items	Description	
Settings assistant	Use <b>[Settings assistant]</b> to guide you through the best picture settings.	
Contrast	Adjusts the intensity of bright areas, keeping dark areas unchanged.	
Brightness	Adjusts the intensity and details of dark areas.	
Color	Adjusts color intensity.	
Tint	Adjusts the color balance in an image.	
Sharpness	Adjusts the level of sharpness in image details.	
Color temperature	Cool	More blue tones.
	Normal	Standard tones.
	Warm	More orange tones.
Dynamic contrast	Off	Sets Dynamic contrast to off.
	On	Automatically enhances contrast in an image.
Digital Natural Motion (Available for 55PFL4706 only)	Off	Sets Digital Natural Motion to off.
	Minimum	Reduces judder in video using low intensity frame interpolation to make the video smooth.
	Maximum	Reduces judder in video using high intensity frame interpolation to make the video smooth.
Noise reduction	Off	Sets Noise reduction to off.
	On	Reduces noise in an image.
MPEG artifact reduction	Off	Sets MPEG artifact reduction to off.
	On	Reduces a blockiness and a blurriness and judder by digital filter.

Setting items	Description	
Color enhancement	Off	Sets Color enhancement to off.
	On	Makes colors more vivid bright colors.
Active control	Off	Sets Active control to off.
	On with Light Sensor	Adjusts backlight for the best picture quality by dynamically adjusting the backlight intensity in accordance with lighting condition in the room.
	On without Light Sensor	Adjusts backlight for best picture quality based on the incoming video signal.
Picture format	Automatic	Refer to 'Summary of picture formats' on page 23.
	Super zoom	
	4:3	
	Movie expand 14:9	
	Movie expand 16:9	
	Wide screen	
Mode selection	PC	Turns off image enhancement features which makes the TV to act purely as a monitor.
	HDTV	Enables image enhancement features to improve picture quality.
Auto adjustment	The horizontal/vertical position, clock and phase of the PC screen are automatically adjusted.	
Clock	Setting to stabilize the PC screen.	
Phase	Setting to improve the clarity of the PC screen.	
Horizontal shift	Adjusts the horizontal position of the picture for PC screen.	
Vertical shift	Adjusts the vertical position of the picture for PC screen.	

- 5 Press **MENU** to exit.

### Note

- **[Mode selection]** will not be displayed when incoming signals are other than 720x480p 60Hz, 1280x720p 60Hz and 1920x1080p 24/30/60Hz.
- **[Digital Natural Motion] (Available for 55PFL4706 only)** If the input video contains adjacent video frames with inherent motion blur captured by the video camera, **[Digital Natural Motion]** will interpolate blur and cause streaking artifacts in high motion scenes. If the content you are watching causes a lot of Interpolation Induced Blur Amplification, it is best to turn off **[Digital Natural Motion]** temporarily.
- **[Digital Natural Motion] (Available for 55PFL4706 only)** uses frame interpolation to make the video appear smooth which causes a video lag of about 200 milliseconds. If you are using the TV for gaming or as a PC monitor DNM will introduce lag. If your gaming system has a lag adjustment feature for your game controller, use it to negate the lag or else turn off DNM for any application where lag is an issue. If you prefer to use DNM while watching movies on your Home Theater PC (HTPC) and are using an external Audio Receiver for sound output, set a 200 millisecond delay on your audio output for A/V sync. You will not experience A/V sync issues for anything other than gaming or HTPC applications since the TV has internal A/V sync functionality.

## Changing picture format

- 1 Press **FORMAT** on the remote control.

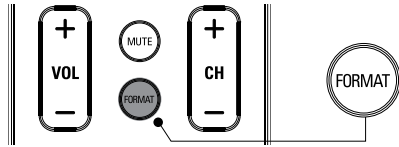

- 2 Use **▲/▼** to select a picture format and press **OK** to confirm your choice.

## Summary of picture formats

Display modes can be selected when the broadcasting station is sending 16:9 or 4:3 video signal. And 3 types of display modes can be selected for PC input signal.

### For 16:9 (480i, 480p, 720p) video signal

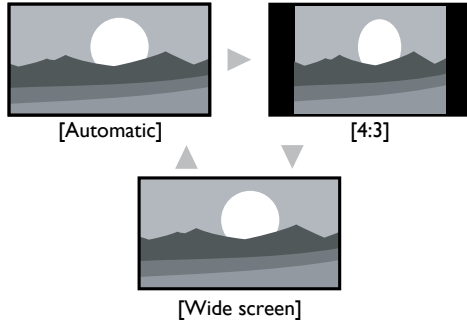

#### Automatic

Other than DTV and HDMI connected devices, enlarges the picture to best fit the screen. DTV and HDMI connected devices display the picture at its original size. The subtitles may remain visible.

#### 4:3

Display a 16:9 picture at a 4:3 size; the picture is shortened horizontally. Sidebars appear on both edges of the screen.

#### Wide screen

Display a 16:9 picture that is stretched horizontally and vertically.

### For 16:9 (1080i, 1080p) video signal

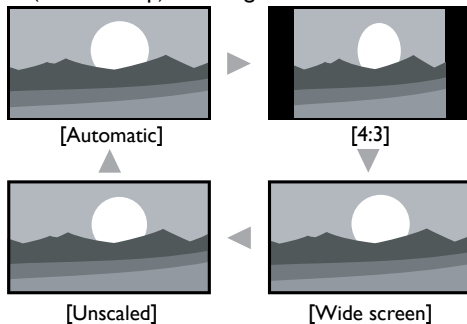

#### Automatic

Other than DTV and HDMI connected devices, enlarges the picture to best fit the screen. DTV and HDMI connected devices display the picture at its original size. The subtitles may remain visible.

#### 4:3

Display a 16:9 picture at a 4:3 size; the picture is shortened horizontally. Sidebars appear on both edges of the screen.

#### Wide screen

Display a 16:9 picture that is stretched horizontally and vertically.

#### Unscaled

Display a 16:9 picture at its original size.

### For 4:3 video signal

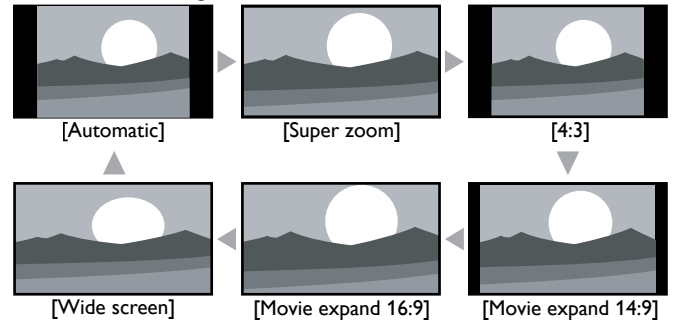

#### Automatic

Other than DTV and HDMI connected devices, enlarges the picture to best fit the screen. DTV and HDMI connected devices display the picture at its original size. The subtitles may remain visible.

#### Super zoom

Display a 4:3 picture at a 16:9 size; the picture is stretched horizontally and vertically and its left and right edges are enlarged. This crops out the top and bottom of the picture.

#### 4:3

Display a 4:3 picture at its original size. Sidebars appear on both edges of the screen.

#### Movie expand 14:9

Display a 4:3 picture at a 14:9 size; the picture is stretched horizontally and vertically. This crops out the top and bottom of the picture. Sidebars appear on both edges of the screen.

#### Movie expand 16:9

Display a 4:3 picture at a 16:9 size; the picture is stretched horizontally and vertically. This crops out the top and bottom of the picture.

#### Wide screen

Display a picture that is stretched out of proportion to fill the screen.

### For PC input signal

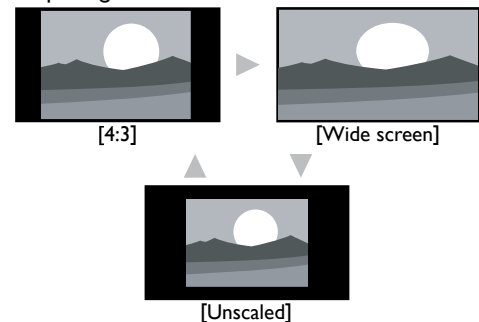

#### 4:3

Display a proportionately stretched picture. Sidebars appear on both edges of the screen.

#### Wide screen

Display a picture that is stretched out of proportion to fill the screen.

#### Unscaled

Display a picture in its original size.

### Note

- Even if you select either **[Automatic]** or **[Wide screen]** in 16:9 video signal, sidebars appear when the broadcasting station is transmitting up-converted 4:3 analog video signal to be visible by digital broadcasting.



## Using your TV as a PC monitor

Use a VGA connector to connect a PC to your TV. For sound, add an audio cable with a stereo mini jack.

### Caution

- Before you connect your PC, set the PC monitor refresh rate to 60Hz.

## Supported screen resolutions

The following screen resolutions are supported in PC mode:

Resolution	Refresh rate
640×480	60Hz
800×600	60Hz
1024×768	60Hz
1280×768	60Hz
1360×768	60Hz
1440×900	60Hz
1280×1024	60Hz
1400×1050	60Hz
1680×1050	60Hz
1920×1080	60Hz

## Changing sound settings

- 1 Press **MENU** on the remote control and then use **▲/▼/◀/▶** to select **[Setup] > [Sound]**.

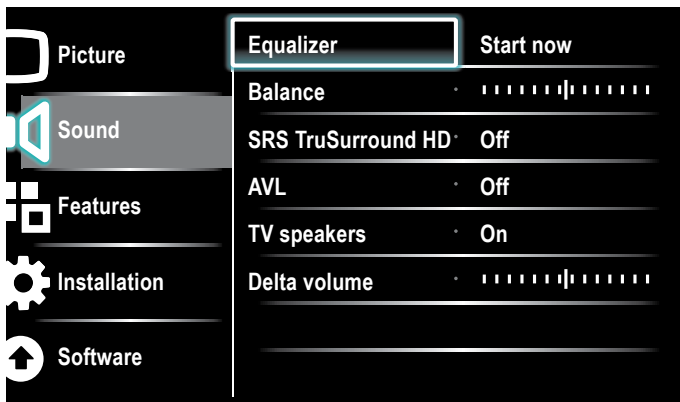

- 2 Use **▲/▼/◀/▶** to highlight a sound setting and then press **OK** to select the setting.
- 3 Adjust the following items.  
The following sound settings can be configured. Depending on the sound source, some sound settings are not available.

Setting items	Description	
Equalizer	Adjust tone quality for each frequency.	
Balance	Adjusts the balance of the right and left speakers to best suit your listening position.	
Digital audio language	Available for digital channels only, when multiple languages are broadcast. Lists available audio languages.	
Alternate audio	Main	Available for analog channels only when a main and second audio program (SAP) is broadcast. Select the main audio program.
	SAP	Available for analog channels only when a main and second audio program (SAP) is broadcast. Select the second audio program.
Mono/Stereo	Mono	Outputs mono-audio.
	Stereo	Outputs stereo-audio.

Setting items	Description		
SRS TruSurround HD	Off On	Sets SRS TruSurround HD to off. Selects available modes for surround sound.	
AVL (Auto Volume Leveling)	Off	Sets AVL to off.	
	On	Reduces sudden changes in volume, for example, during commercials or when switching channels.	
TV speakers	Off	The sound will not be output from the unit's speakers.	
	On	The sound will be output from the unit's speakers.	
	Speakers EasyLink	You can control audio output from your connected EasyLink Compliant Devices with <b>VOL +/-</b> by using this unit's remote control.	
Delta volume	If a channel or input device is:	Too Loud	Navigate to that channel or input device and set a negative delta volume level as per your personal preferences.
		Too Soft	Navigate to that channel or input device and set a positive delta volume level as per your personal preferences.

- 4 Press **MENU** to exit.

### Note

- **[Master EasyLink]** must be activated in the **[Preferences]** menu to make the **[TV Speakers]** menu available when you select **[On]** or **[Speakers EasyLink]**.

## Using auto mode

- 1 Press **AUTO MODE** to set your TV to a predefined picture and sound setting.
- 2 Use **▲/▼** to select one of the following settings:
  - **[Personal]**: The customized settings you defined by using the **[Picture]** menu.
  - **[Sports]**: Vivid picture settings and clear sound for high action.
  - **[Standard]**: For normal TV viewing.
  - **[Movie]**: Brilliant picture settings for a cinematic experience.
  - **[Game]**: Optimized for PCs, games consoles and playstations.
  - **[Internet Video]**: Optimized for low bitrate internet video.
  - **[Power Saver]**: Eco TV settings for lower power consumption.

## Create and use lists of favorite channels

You can create lists of your preferred TV channels so that you can find those channels easily.

### Select a list of favorite channels

- 1 Press **FAV** on the remote control.

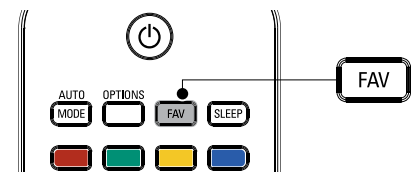

- ↳ Your lists of favorite channels are displayed.
- 2 Use **▲/▼** to highlight a list, and then press **OK** to select the list.

## Create or edit a list of favorite channels

- 1 Press **FAV** on the remote control to display your lists of favorite channels.
- 2 Use **▲/▼** to highlight a list, and then press **OK** to select the list.
- 3 Press **OPTIONS** to enter edit mode.
  - ↳ A list of channels is shown.
- 4 Use **▲/▼** to highlight a channel.
- 5 Press **OK** to select or deselect the highlighted channel.
  - ↳ The channel is added to or removed from the list of favorite channels.
- 6 Press **MENU** to exit.

## Switch to one of the channels on a list

- 1 Press **OK** on the remote control to display the last list that you selected.
- 2 Use **▲/▼** to highlight a channel.
- 3 Press **OK** to select the channel.
  - ↳ The TV switches to that channel.



Tip

- Press **CH +/-** to select channels in a list or press the numeric keys to select channels that are not in a list.

## Setting the clock

You can set the time on your TV.

### Setting the time automatically

Some digital channels transmit the time. For these channels, you can set the time automatically and choose which channel to read the time from.

- 1 Press **MENU** on the remote control and then use **▲/▼/◀/▶** to select **[Setup] > [Installation] > [Clock] > [Auto clock mode]**.
- 2 Select **[Automatic]** and then press **OK** to confirm your choice.
- 3 Select the channel from which the TV reads the time.
  - Use **▲/▼** and then press **OK** to enter the menu for **[Auto clock channel]**.
  - Use **▲/▼** to highlight a channel.
  - Press **OK** to confirm your choice.
- 4 (Optional) Select the time zone.
  - Use **▲/▼** and then press **OK** to enter the menu for **[Time zone]**.
  - Use **▲/▼** to highlight the time zone.
  - Press **OK** to confirm your choice.
- 5 (Optional) Set daylight saving.
  - Use **▲/▼** and then press **OK** to enter the menu for **[Daylight saving]**.
  - Use **▲/▼** to highlight **[Automatic]** or **[Off]**.
  - Press **OK** to confirm your choice.
- 6 Press **MENU** to exit.

## Setting the time manually

- 1 Press **MENU** on the remote control and then use **▲/▼/◀/▶** to select **[Setup] > [Installation] > [Clock] > [Auto clock mode]**.
- 2 Select **[Manual]**, and then press **OK** to confirm your choice.
- 3 Use **▲/▼** to select **[Time]** and then press **OK** to set the time. Use the format HH:MM. Select **[AM]/[PM]** for morning or afternoon.
- 4 Press **BACK** to confirm your choice.
- 5 Use **▲/▼** and then press **OK** to enter the menu for **[Day]**.
- 6 Use **▲/▼** to select the day.
- 7 Press **OK** to confirm your choice.
- 8 Press **MENU** to exit.

## Closed caption

Closed captioning is an assistive technology that allows persons with hearing disabilities to access television programming. Closed captioning displays the audio portion of programming as text superimposed over the video.



Note

- Closed captioning service may not be controlled by this unit's menu options if you are watching television through an external cable or satellite set top box. In which case you will need to use the menu options on the external set top box to control Closed Captioning.
- The captions do not always use correct spelling and grammar. Not all TV programs and product commercials include closed caption information. Refer to your area TV program listings for the TV channels and times of closed caption shows. The captioned programs are usually noted in the TV listings with service marks such as [CC].

## Display captions

- 1 Press **MENU** on the remote control and then use **▲/▼/◀/▶** to select **[Setup] > [Features] > [Caption settings] > [Closed captions]**.
- 2 Press **▲/▼** to select **[On]**, **[Off]** or **[On during mute]**, and press **OK** to confirm your choice.
- 3 Press **MENU** to exit.

DTV

## Selecting DTV caption services

- 1 Select a caption service for digital channels:
  - Press **MENU** on the remote control and then use **▲/▼/◀/▶** to select **[Setup] > [Features] > [Caption settings] > [Digital caption service]**.
  - Use **▲/▼** to select one of the listed caption services, and then press **OK** to confirm your choice.

CS-1 to CS-6

Select one of these before changing any other item in **[Caption settings]** menu. Choose **[CS-1]** under normal circumstances.

- 2 Press **MENU** to exit.

## Selecting how captions are displayed

You can choose the size, font, color, background and other characteristics of the caption text.

- 1 Press **MENU** on the remote control and then use **▲/▼/◀/▶** to select **[Setup] > [Features] > [Caption settings] > [Digital caption options]**.
- 2 Use **▲/▼** to highlight an option for digital captions, and press **OK** to select the option.
- 3 Use **▲/▼** to highlight a setting for the option, and press **OK** to confirm your choice.
- 4 Press **MENU** to exit.

## Difficulties viewing closed captions on DTV programming

If you have difficulties viewing closed captions on DTV programming, including HDTV, received from your subscription television provider, you should:

- consult any consumer information and manuals/guides on closed captions for DTV programming provided by your subscription television provider;
- ensure that the captioning function on your set-top box, if applicable, is turned on; and,
- ensure that the captioning function on your DTV is turned on.

If you are still unable to view closed captions on DTV programming, you should contact your subscription television provider for assistance.

### TV

## Selecting caption services

- 1 Select a caption service for analog channels:
  - Press **MENU** on the remote control and then use **▲/▼/◀/▶** to select **[Setup]** > **[Features]** > **[Caption settings]** > **[Caption service]**.
  - Use **▲/▼** to select one of the listed caption services, and press **OK** to confirm your choice.
- 2 Press **MENU** to exit.

### Note

- Not all caption services are used by a TV channel during the transmission of a closed caption program.

## Summary of caption services

Service	Description
CC-1 and T-1;	are the primary caption and text services. The captioning or text is displayed in the same language as the program's dialogue (up to 4 lines of script on the TV screen, where it does not obstruct relevant parts of the picture).
CC-3 and T-3;	serve as the preferred data channels. The captioning or text is often a secondary language.
CC-2, CC-4, T-2 and T-4;	are rarely available and broadcasters use them only in special conditions, such as when <b>[CC-1]</b> and <b>[CC-3]</b> or <b>[T-1]</b> and <b>[T-3]</b> are not available. <ul style="list-style-type: none"><li>• There are 3 display modes according to programs: <b>Paint-on mode:</b> Displays input characters on the TV screen immediately. <b>Pop-on mode:</b> Once characters are stored in memory, they are displayed all at once. <b>Roll-up mode:</b> Displays the characters continuously by scrolling (max. 4 lines).</li></ul>

## Sleeptimer

You can always put your TV in standby mode earlier or reset the sleeptimer during the countdown.

- 1 Press **SLEEP** to set the sleeptimer.  
(Also, you can set the sleeptimer in **[Features]** menu.)
- 2 Use **SLEEP** or **◀/▶** repeatedly to change the amount of time (in increments of 30 minutes up to 180 minutes).
  - Each press of **SLEEP** or **▶** will increase the time by 5 minutes.
  - Each press of **◀** will decrease the time by 5 minutes.
  - After setup, the sleep timer display can be called up for checking by pressing **SLEEP**.

### Tip

To Cancel the Sleep Timer

- Press **SLEEP** or **◀/▶** repeatedly until "0" is displayed on the TV screen.

## Child and rating locks

You can prevent your children from watching certain programs or certain channels by locking the TV controls and by using ratings.

## Setting your PIN

- 1 Press **MENU** on the remote control and then use **▲/▼/◀/▶** to select **[Setup]** > **[Features]** > **[Child lock]**.
- 2 Enter a 4-digit PIN on the **Number buttons**, of the remote control.
  - If you have not set up your PIN, enter **[0]**, **[0]**, **[0]**, **[0]**.

## Changing your PIN

- 1 Press **MENU** on the remote control and then use **▲/▼/◀/▶** to select **[Setup]** > **[Features]** > **[Change PIN]**.
- 2 Enter a 4-digit PIN on the **Number buttons** of the remote control.
  - If you have a PIN, enter your current PIN.
  - If you do not have a PIN, enter **[0]**, **[0]**, **[0]**, **[0]**.
  - If you have forgotten your PIN, enter **[0]**, **[7]**, **[1]**, **[1]**.
- 3 Enter your new PIN.
- 4 Enter your PIN again to confirm.
- 5 Press **MENU** to exit.

## Lock the TV

This section describes how to lock all channels on the TV. At the specified time, screen is blanked out and the audio is muted.

- 1 Ensure that the clock is set with the current time. (See 'Setting the clock' on page 25.)
- 2 Press **MENU** on the remote control and then use **▲/▼/◀/▶** to select **[Setup]** > **[Features]** > **[Child lock]**.
- 3 Enter your PIN. (See 'Setting your PIN' on page 26.)
- 4 Use **▲/▼** to select **[Lock after]**, then press **OK**.
- 5 Press **OK** to select **[Timer]**.
- 6 Use **▲/▼** to select **[On]** and activate the **[Lock after]** feature. Select **[Off]** to deactivate the feature.
- 7 Press **OK** to confirm your choice.
- 8 Use **▲/▼** to select **[Time]** and then press **OK** to set the time. Use the format HH:MM, and select **[AM]** / **[PM]** for morning or afternoon.
- 9 Press **BACK** to confirm the time.
- 10 Press **MENU** to exit.
- 11 Turn the TV off and on again.

## Locking a channel or input source

This section describes how to lock input sources or specified channels. The channels can be selected but the screen is blanked out and the audio is muted.

- 1 Press **MENU** on the remote control and then use **▲/▼/◀/▶** to select **[Setup] > [Features] > [Child lock]**.
- 2 Enter your PIN. (See 'Setting your PIN' on page 26.)
- 3 Use **▲/▼** to select **[Channel Lock]**, then press **OK**.

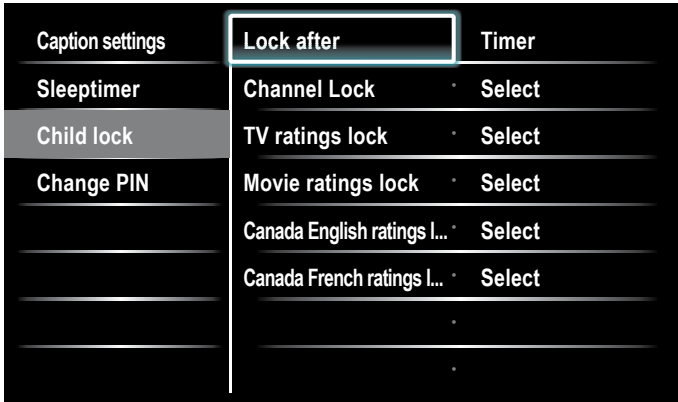

- 4 Use **▲/▼** and then press **OK** repeatedly to switch between locked and not locked. Each rating has a box-graphic in front of it to indicate whether it is locked:
  - A box with **x** indicates that the channel or input source is locked.
  - An empty box indicates that the channel or input source is not locked.
- 5 Press **MENU** to exit.

## Using the TV ratings lock

Your TV is equipped with a V-chip that allows you to control access to individual programs based on their age rating and content rating. The program content advisory data are sent by the broadcaster or by the program provider.

If you receive channels through a set-top box or cable box connected by HDMI, you cannot use the TV ratings lock. Your set-top box or cable box must be connected through RF or AV connectors.

- 1 Press **MENU** on the remote control and then use **▲/▼/◀/▶** to select **[Setup] > [Features] > [Child lock]**.
- 2 Enter your PIN. (See 'Setting your PIN' on page 26.)
- 3 Use **▲/▼** to select **[TV ratings lock]**, then press **OK**.
- 4 Use **▲/▼/◀/▶** and then press **OK** repeatedly to switch between locked and not locked.

Each rating has a box-graphic in front of it to indicate whether it is locked:

- A box with **x** indicates that all items in the content ratings list are locked.
- An empty box indicates that no items in the content ratings list are locked.
- A box with **/** indicates that some items in the content ratings are already locked and some items remain not locked.

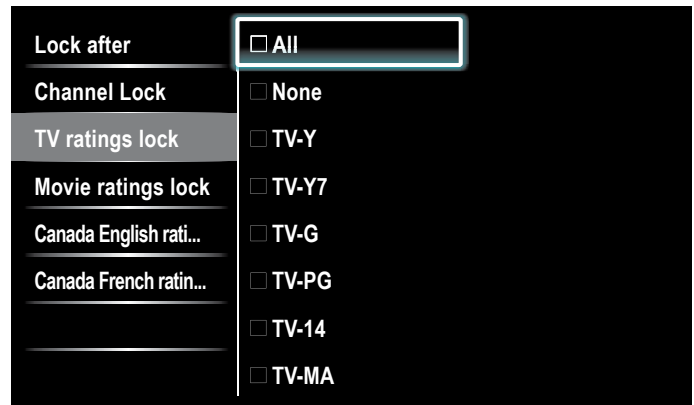

- When you select **[All]**, all items in the ratings list are locked.
- When you select **[None]**, programs with no rating and programs with a rating of none are locked.
- When you lock a rating, all ratings in the younger age categories are automatically locked.

- 5 Press **MENU** to exit.

## Summary of TV ratings

Age rating	Content rating
All	None
None	None
TV-Y : Appropriate for children of all ages with themes and elements suitable for children aged 2-6.	None
TV-Y7 : Programs designed for children age 7 and older.	[Fantasy Violence]
TV-G : Programs suitable for all ages. These programs contain little or no violence, no strong language and little or no sexual dialog or situations.	None
TV-PG : Programs contain elements that some parents may find unsuitable for younger children and which may need parental guidance. The program may contain moderate violence, sexual dialog and/or situations and some strong language.	[Dialog] [Language] [Sex] [Violence]
TV-14 : Programs contain elements that may not be suitable for children under 14 years of age. These programs include one or more of the following: intense violence, intense sexual situations, suggestive dialog and strong language.	[Dialog] [Language] [Sex] [Violence]
TV-MA : Programs are designed to be viewed by adults and may be unsuitable for children under the age of 17. These programs may contain graphical violence, explicit sexual activity and/or crude or indecent language.	[Language] [Sex] [Violence]

### Note

- The V-Chip can block non rated programs as per "CEA-608-E sec. L3". If the option to block **[None]**, **[NR]**, **[E]** or **[E]** programs is used in **[TV ratings lock]**, **[Movie ratings lock]**, **[Canada English ratings lock]** or **[Canada French ratings lock]** accordingly "unusual results may occur; and the unit may not receive emergency bulletins or other types of programming": Emergency Bulletins (Such as EAS messages, weather warnings and others) · Locally originated programming · News · Political · Public Service Announcements · Religious · Sports · Weather.

## Using the movie ratings lock

You can control viewing of movies based on their MPAA (Motion Picture Association of America) rating.

**1** Press **MENU** on the remote control and then use **▲/▼/◀/▶** to select **[Setup] > [Features] > [Child lock]**.

**2** Enter your PIN. (See 'Setting your PIN' on page 26.)

**3** Select one of the menus for movie ratings lock.

- In the USA, select **[Movie ratings lock]**.
- In Canada, select **[Canada English ratings lock]** or **[Canada French ratings lock]**.

The following screen shows the ratings in **[Movie ratings lock]**.

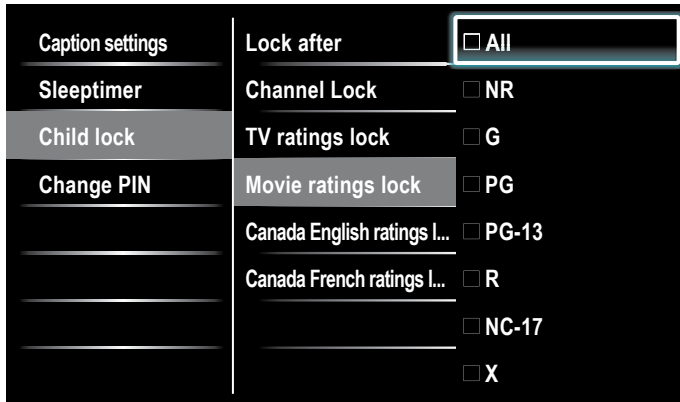

**4** Use **▲/▼** and then press **OK** repeatedly to switch between locked and not locked. Each rating has a box-graphic in front of it to indicate whether it is locked:

- A box with **x** indicates that all items in the rating are locked.
- An empty box indicates that no items in the rating are not locked.
- When you select **[All]**, all items in the ratings list are locked.

**5** Press **MENU** to exit.

## Summary of Movie ratings lock

Rating	Description
All	All items in the ratings list are locked.
NR	Not rated.
G	Movies with a mild content, suitable for all ages.
PG	Movies for which parental guidance is recommended. They may contain a few racy or violent scenes or maybe some bad language.
PG-13	Movies for which parental guidance may be recommended if under age 13.
R	Restricted. The movies usually contain offensive sex or bad language and may be unsuitable for children under the age of 17. Parental guidance or permission needed.
NC-17	Even with parental permission, forbidden under age 17. More offensive sex, violence or bad language.
X	Movies which generally focus on sex, violence and/or bad language. Also known as pornography.

## Summary of Canada English ratings lock

Rating	Description
All	All items in the ratings list are locked.
E	Exempt program.
C	Programming suitable for children under the age of 8 years. No profanity or sexual content of any level allowed. Minimal comedic violence.
C8+	Suitable for children ages 8 and over. Low intensity violence and fantasy horror allowed.
G	Movies with a mild content, suitable for all ages.
PG	Movies for which parental guidance is recommended. They may contain a few racy or violent scenes or maybe some bad language.
14+	Programming intended for children ages 14 and over. May contain intense scenes of violence, strong profanity, and depictions of sexual activity within the context of a story.
18+	Programming intended for viewers ages 18 and over. May contain strong violence, language, and sexual activity.

## Summary of Canada French ratings lock

Rating	Description
All	All items in the ratings list are locked.
E	Exempt program.
G	Appropriate for all ages with little or no violence and little to no sexual content.
8ans+	Appropriate for children 8 and up which may contain little violence, some foul language and/or little to no sexual content.
13ans+	Appropriate for children 13 and up, with moderate violence, language, and some sexual situations. Persons under 13 should be accompanied by an adult.
16ans+	Appropriate for children 16 and up, with strong violence, strong language, and strong sexual content.
18ans+	Only to be viewed by adults and contains extreme violence and graphic sexual content/pornography.

### Note

- The V-Chip can block non rated programs as per "CEA-608-E sec. L.3". If the option to block **[None]**, **[NR]**, **[E]** or **[E]** programs is used in **[TV ratings lock]**, **[Movie ratings lock]**, **[Canada English ratings lock]** or **[Canada French ratings lock]** accordingly "unusual results may occur, and the unit may not receive emergency bulletins or other types of programming:"  
Emergency Bulletins (Such as EAS messages, weather warnings and others) · Locally originated programming · News · Political · Public Service Announcements · Religious · Sports · Weather.

## Use the region ratings lock

You can control access to digital programs based on downloaded region ratings. Before you download a ratings table, ensure that regional ratings are broadcast.

**1** Press **MENU** on the remote control and then use **▲/▼/◀/▶** to select **[Setup] > [Features] > [Child lock]**.

**2** Enter your PIN. (See 'Setting your PIN' on page 26.)

**3** Use **▲/▼** to select **[Region ratings lock]**, then press **OK**.

**4** Use **▲/▼** and then press **OK** repeatedly to switch between locked and not locked. Each rating has a box-graphic in front of it to indicate whether it is locked:

- A box with **x** indicates that the rating is locked.
- An empty box indicates that the rating is not locked.

**5** Press **MENU** to exit.

## Use Philips EasyLink

Your TV supports Philips EasyLink, which enables one-touch play and one-touch standby between EasyLink-compliant devices. Compliant devices must be connected via an HDMI connector.

### One-touch play

When you connect your TV to devices that support one-touch play, you can control your TV and the devices with one remote control. For example, when you press **▶ (play)** on your DVD remote control, your TV automatically switches to the correct channel to show the DVD content.

### One-touch standby

When you connect your TV to devices that support standby, you can use your TV remote control to put your TV and all connected HDMI devices in standby mode. You can perform one-touch standby using the remote control from any of the connected HDMI devices.

### System audio control

When you connect your TV to HDMI CEC compliant devices, your TV can switch automatically to play audio from the connected device. To use one-touch audio, you must map the audio input from the connected device to your TV.

You can use the remote control from the connected device to adjust the volume.

### Remote control (RC) key forwarding

RC key forwarding allows you to control EasyLink-compliant devices using your TV remote control.

### Audio Return Channel (ARC)

HDMI ARC allows you to use Philips EasyLink to output TV audio directly to a connected audio device, without the need for an additional digital audio cable. HDMI ARC supports more digital audio formats than S/PDIF. Be sure that the device is HDMI-CEC and ARC compliant, and that the TV is connected to the device using an HDMI cable attached to HDMI ARC connectors.

## Activate Master EasyLink

- 1 Press **MENU** on the remote control and then use **▲/▼/◀/▶** to select **[Setup] > [Installation] > [Preferences] > [EasyLink] > [Master EasyLink]**.
- 2 Use **▲/▼** to select **[On]**.

### Note

- Select **[Off]** to disable this function.
- Philips does not guarantee 100% interoperability with all HDMI CEC devices.
- The EasyLink-compliant device must be switched on and selected as the source.

**[Master EasyLink]** must be activated in the **[Preferences]** menu to make the **[TV Speakers]** menu available in the **[Sound]** menu.

## EasyLink

This function allows you to operate the linked functions between our brand devices with EasyLink capabilities and this unit connected via a HDMI cable.

- 1 Press **MENU** on the remote control and then use **▲/▼/◀/▶** to select **[Setup] > [Installation] > [Preferences] > [EasyLink]**.

Location	Master EasyLink	On
EasyLink	Auto TV On	On
	RC Key forwarding	Select
	HDMI-ARC	On
	Device List	Select

- 2 Use **▲/▼** to highlight the desired setting and then press **OK** to select the setting.
- 3 Adjust the following items.
  - [Master EasyLink]**  
Set the EasyLink **[On]** or **[Off]**.  
The following additional settings will disappear when you set to **[Off]**.  
Use **▲/▼** to select the desired option, then press **OK**.

Off	Disable all EasyLink.
On	Select if you have connected an external device that is compatible with the EasyLink function.

### [Auto TV On]

Use **▲/▼** to select the desired option, then press **OK**.

Off	This unit remains in standby mode even if you turn on your connected EasyLink device.
On	This unit turns on automatically when you turn on your connected EasyLink device.

### [RC Key forwarding]

Use **▲/▼** to select the desired option, then press **OK**.

HDMI1 to HDMI4	Select enable or disable RC key forwarding if this unit connected through HDMI1 to HDMI4 to your EasyLink devices.
----------------	--

### [HDMI-ARC]

Use **▲/▼** to select the desired option, then press **OK**.

Off	Disable HDMI-ARC.
On	You can output TV audio through the HDMI cable solely, provided both the TV and device are HDMI ARC compliant.

### [Device List]

This function lets you see the product name of connected devices. Use **▲/▼** to select the desired HDMI device listed on the TV screen, then press **OK**.

- 4 Press **MENU** to exit.

## Set your location to home

You can set the location of your TV to **[Home]** or **[Retail store]**. Choosing **[Home]** gives you full flexibility to change predefined settings for picture and sound.

- 1 Press **MENU** on the remote control and then use **▲/▼/◀/▶** to select **[Setup] > [Installation] > [Preferences] > [Location]**.
- 2 Select **[Home]** and then press **OK** to confirm your choice.
- 3 Press **MENU** to exit.

### Note

- You must set **[Home]**. Otherwise, personalized picture and sound settings will not be memorized after the unit goes to standby mode.

## Network

Set up network connection settings in order to use Net TV or network update function.

### Network setting assistant

Before you proceed to **[Connection test]** or other settings in **[Network]** section, set this selection to suit your preference.

#### Wireless setting

Select to use a wireless LAN to connect to the internet by wireless connection.

- 1 Press **MENU** on the remote control and then use **▲/▼/◀/▶** to select **[Setup] > [Installation] > [Network] > [Network setting assistant] > [Wireless]**.
- 2 Use **▲/▼** to select a setting and then press **OK**.

Setting items	Description
Easy connect	Select this setting if your router has a Wi-Fi Protected Setup (WPS) button. Start scanning for wireless networks on the TV after pressing the WPS button on your router. If connection test fails, refer to the router's manual for more details.
Scan	Search for wireless networks automatically and select the wireless network name (SSID) from the list. see 'Wireless network setting (Auto)' on page 30.
Manual entry	Set up the connection to the Wireless LAN Access Point (AP) (e.g. wireless router) manually by entering the wireless network name (SSID). see 'Wireless network setting (Manually enter your SSID)' on page 30.

- 3 Press **MENU** to exit.

#### Wired setting

Select to use an Ethernet cable to connect to the internet by wired connection.

- 1 Press **MENU** on the remote control and then use **▲/▼/◀/▶** to select **[Setup] > [Installation] > [Network] > [Network setting assistant] > [Wired]**.
- 2 Use **▲/▼** to select a setting and then press **OK**.  
Connection test will start automatically. (See 'Connection test' on page 30.)
- 3 Press **MENU** to exit.

## Network selection

- 1 Press **MENU** on the remote control and then use **▲/▼/◀/▶** to select **[Setup] > [Installation] > [Network] > [Manual network settings] > [Network selection]**.
- 2 Use **▲/▼** to select a setting and then press **OK**.

Setting items	Description
Wireless	Select to use a wireless LAN to connect to the internet by wireless connection.
Wired	Select to use an Ethernet cable to connect to the internet by wired connection.

- 3 Press **MENU** to exit.

## Connection test

Perform the following steps to test your internet connection after you have connected an Ethernet cable or entered network settings such as IP address, DNS settings, etc. manually.

- 1 Press **MENU** on the remote control and then use **▲/▼/◀/▶** to select **[Setup] > [Installation] > [Network] > [Connection test]**.  
Connection test will start automatically and the test result will appear right after the connection test finishes.
  - **[Testing...]**: The test is in progress.
  - **[Pass]**: Connection test is successfully completed.
  - **[Fail]**: Connection test failed. Check the connection settings.Press **OK** to go to the list of network status confirmation screen.
- 2 Press **MENU** to exit.

### Note

- If the connection test passes, you are ready to use Net TV or network update function using the internet without making any additional settings.
- If the connection test fails, check if the Ethernet cable is connected to this TV properly or if you have entered all the required details for the wireless LAN connection properly.

## Wireless network

This menu is displayed only when you set **[Wireless]** in **[Network selection]**. In order to use a wireless network, you must set up a connection to the Wireless LAN Access Point (AP) (e.g. wireless router).

### Wireless network setting (Auto)

Search for wireless networks automatically and select the wireless network name (SSID) from the list.

- 1 Press **MENU** on the remote control and then use **▲/▼/◀/▶** to select **[Setup] > [Installation] > [Network] > [Manual network settings] > [Wireless network setting] > [Auto]**.
  - This unit will start searching for wireless networks automatically.
- 2 The list of wireless networks will be displayed. Use **▲/▼** to select the appropriate wireless network name (SSID), then press **OK**.
  - If you select the wireless network name (SSID) with **WEP/WPA** Key entry screen will appear.  
Enter the WEP/WPA key of the selected wireless network using **▲/▼/◀/▶**, then press **OK**.  
**[Clear]** : Clear the entered number or word.  
**[All clear]** : Clear all the entered numbers or words.  
**[a/A/@]** : Switch between abc, ABC and @!?  
**[Cancel]** : Shows the cancellation display.  
**[OK]** : Set the entered number or word.
  - If you select the wireless network name (SSID) has Wi-Fi protected Setup (WPS), WPS setting screen will appear. Use **▲/▼/◀/▶** to select a setting and then press **OK**.

Setting items	Description
Easy connect	Select this setting if your router has a Wi-Fi Protected Setup (WPS) button. Start scanning for wireless networks on the TV after pressing the WPS button on your router. If connection test fails, refer to the router's manual for more details.
WPS code	Select this setting if your router has Wi-Fi Protected Setup (WPS) but does not have a WPS button. Enter the 8-digit WPS PIN code shown on your TV in the router settings menu via PC before <b>[Connect]</b> is selected.
Manual	If your wireless network with authentication setting (WEP/WPA-PSK or WPA2-PSK), WEP/WPA Key entry screen will appear. Enter the WEP/WPA key of the selected wireless network using <b>▲/▼/◀/▶</b> , then press <b>OK</b> . <b>[Clear]</b> : Clear the entered number or word. <b>[All clear]</b> : Clear all the entered numbers or words. <b>[a/A/@]</b> : Switch between abc, ABC and @!? <b>[Cancel]</b> : Shows the cancellation display. <b>[OK]</b> : Set the entered number or word.

- Confirmation message will appear. Select **[Yes]** to complete the settings.

### 3 Press **MENU** to exit.

#### Note

- For a wireless network with authentication setting, key icon appears to the right hand of the wireless network name (SSID).
- Signal icon shows the strength of the signal.
- WEP/WPA key appears as asterisks on the confirmation screen.
- The wireless LAN supports following specifications.
  - Wireless standards : IEEE 802.11 b/g/n
  - Frequency spectrum : 2.4GHz
  - Security protocol : WEP/WPA/WPA2

### Wireless network setting (Manually enter your SSID)

Set up the connection to the Wireless LAN Access Point (AP) (e.g. wireless router) manually by entering the wireless network name (SSID).

#### 1 Press **MENU** on the remote control and then use **▲/▼/◀/▶** to select **[Setup]** > **[Installation]** > **[Network]** > **[Manual network settings]** > **[Wireless network setting]** > **[Manually enter your SSID]**.

- Wireless LAN Access Point (AP) (e.g. wireless router) Name (SSID) entry screen will appear. Enter the wireless network name (SSID) using **▲/▼/◀/▶**, then press **OK**.  
**[Clear]** : Clear the entered number or word.  
**[All clear]** : Clear all the entered numbers or words.  
**[a/A/@]** : Switch between abc, ABC and @!?  
**[Cancel]** : Shows the cancellation display.  
**[OK]** : Set the entered number or word.

#### 2 Use **▲/▼** to select the authentication setting of the selected wireless network.

- For a wireless network with authentication setting, select the authentication setting, according to the security type of the wireless network.
- For a wireless network without authentication setting, select **[None]**.

##### **[None]**

Set the authentication setting to **[None]**.

##### **[WEP]**

Set the authentication setting to **[WEP]**.

##### **[WPA-PSK]**

Set the authentication setting to **[WPA-PSK]**.

##### **[WPA2-PSK]**

Set the authentication setting to **[WPA2-PSK]**.

- If you select **[WEP]**, **[WPA-PSK]** or **[WPA2-PSK]**, WEP/WPA Key entry screen will appear. Enter the WEP/WPA key of the selected wireless network using **▲/▼/◀/▶**, then press **OK**.  
**[Clear]** : Clear the entered number or word.  
**[All clear]** : Clear all the entered numbers or words.  
**[a/A/@]** : Switch between abc, ABC and @!?  
**[Cancel]** : Shows the cancellation display.  
**[OK]** : Set the entered number or word.
- Confirmation message will appear. Select **[Yes]** to complete the settings.

### 3 Press **MENU** to exit.

### IP configuration

In following cases, select **[IP configuration]** to set each setting as necessary.

- When connection test failed with the setting of **[Connection test]**.
- When instructed by your internet service provider to make specific settings in accordance with your network environment.

#### 1 Press **MENU** on the remote control and then use **▲/▼/◀/▶** to select **[Setup]** > **[Installation]** > **[Network]** > **[Manual network settings]** > **[IP configuration]**.

#### 2 Use **▲/▼** to select a setting and then press **OK**.

Setting items		Description
IP setting mode	Auto	Sets the IP setting automatically.
	Manual	Sets the IP setting manually.
IP address *1,3		A set of numbers which are assigned to devices participating in a computer network.
Subnet mask *1,3		A mask which is used to determine what subnet an IP address belongs to.
Default gateway *1,3		IP address of the network device (such as router) which provides internet access.
DNS setting mode	Auto	Sets the DNS setting automatically.
	Manual	Sets the DNS setting manually.
Primary DNS *2,3		A server which handles the name and IP address over the internet.
Secondary DNS *2,3		A server which handles the name and IP address over the internet.
MAC address		An address which recognizes the devices connecting to the network. It is also called Hardware Address.

\*1 Items can be selected only when **[IP setting mode]** is set to **[Manual]**.

\*2 Items can be selected only when **[DNS setting mode]** is set to **[Manual]**.

\*3 Use **▲/▼** or the **Number buttons** to input numbers. When you press **▲/▼** to input numbers then press **OK** or input the triple digits by using the **Number buttons**, the cursor moves to the next entry field. When you press **▲/▼** to input numbers then press **OK** or input the triple digits by using the **Number buttons** at the rightmost entry field, numbers will be stored and go back to the previous menu.

#### 3 Press **MENU** to exit.

#### Note

- The range of input numbers is between 0 and 255.
- If you enter a number larger than 255, the number will automatically be 255.
- The manually entered number will be saved even if you change the setting to **[Auto]**.
- When you enter a wrong number, press **Color buttons (red)** to cancel. (the number will be back to **[0]**.)
- If you want to enter 1 or 2 digit number in one cell, press **OK** to move on to the next cell.
- If the entered IP address or the default gateway or primary DNS number is same as the default setting, IP address setting will be set to **[Auto]**. (The manually entered number will be saved).
- When IP address setting is set to **[Manual]**, the setting of DNS setting will automatically be **[Manual]** and when IP address setting is set to **[Auto]**, you can set either **[Auto]** or **[Manual]** for DNS setting.



## Proxy configuration

- 1 Press **MENU** on the remote control and then use **▲/▼/◀/▶** to select **[Setup] > [Installation] > [Network] > [Manual network settings] > [Proxy configuration]**.
- 2 Use **▲/▼** to select a setting and then press **OK**.
  - For default settings, select **[Do Not Use]**.
  - If you need to change the proxy setting as instructed by your internet service provider to set the designated proxy address and port, select **[Use]**.

Setting items	Description	
Proxy setting	Do not Use	Not use the proxy server.
	Use	Uses the proxy server.
Proxy address*	Selects the number or word by using <b>▲/▼/◀/▶</b> , then press <b>OK</b> . <b>[Clear]</b> : Clear the entered number or word. <b>[All clear]</b> : Clear all the entered numbers or words. <b>[a/A/@]</b> : Switch between abc, ABC and @!? <b>[Cancel]</b> : Shows the cancellation display. <b>[OK]</b> : Set the entered number or word.	
Proxy port*	Use <b>▲/▼</b> or the <b>Number</b> buttons to input numbers.	

\* Items can be selected only when **[Proxy port]** is set to **[Use]**.

- 3 Press **MENU** to exit.

### Note

- The range of input numbers for the port number is between 0 and 65535. (If you enter a number larger than 65535, it will be regarded as 65535.)
- For proxy port, the selected ports may be blocked and not be able to use depending on your network environment.
- If the proxy address is entered with blank only, proxy server setting will be set to **[Do Not Use]**.

## Setting status

You can check the status of network settings.

- 1 Press **MENU** on the remote control and then use **▲/▼/◀/▶** to select **[Setup] > [Installation] > [Network] > [Setting status]**.
  - Network setting list will be displayed.
  - MAC address of this unit will be displayed in the list.
- 2 Press **MENU** to exit.

## Reset network settings

You can reset the status of network settings.

- 1 Press **MENU** on the remote control and then use **▲/▼/◀/▶** to select **[Setup] > [Installation] > [Network] > [Reset network settings] > [Start now]**.
- 2 Press **OK** to reset the network settings.
- 3 Press **MENU** to exit.

## Netflix deactivation

Displays the deactivation setting for Netflix.

- 1 Press **MENU** on the remote control and then use **▲/▼/◀/▶** to select **[Setup] > [Software] > [Netflix deactivation]**.
- 2 Use **▲/▼** to select the desired option, then press **OK**.

Setting items	Description
Yes	Deactivate the connection to Netflix.
No	Activate the connection to Netflix.

- 3 Press **MENU** to exit.

## Netflix ESN

Displays the ESN information.

- 1 Press **MENU** on the remote control and then use **▲/▼/◀/▶** to select **[Setup] > [Software] > [Netflix ESN]**.
  - Displays the ESN (Electronic Serial Number) to get any services from Netflix.
- 2 Press **MENU** to exit.

## VUDU deactivation

Displays the deactivation setting for VUDU.

- 1 Press **MENU** on the remote control and then use **▲/▼/◀/▶** to select **[Setup] > [Software] > [VUDU deactivation]**.
- 2 Use **▲/▼** to select the desired option, then press **OK**.

Setting items	Description
Yes	Deactivate the connection to VUDU.
No	Activate the connection to VUDU.

- 3 Press **MENU** to exit.

## YouTube deactivation

Displays the deactivation setting for YouTube.

- 1 Press **MENU** on the remote control and then use **▲/▼/◀/▶** to select **[Setup] > [Software] > [YouTube deactivation]**.
- 2 Use **▲/▼** to select the desired option, then press **OK**.

Setting items	Description
Yes	Deactivate the connection to YouTube.
No	Activate the connection to YouTube.

- 3 Press **MENU** to exit.

## View photos and play music, and watch videos on a USB storage device

### Caution

- This unit accepts USB flash memory only. Other storage devices such as external HDD by USB bus power will not work.
- Philips is not responsible if the USB storage device is not supported nor is it responsible for damage or loss of data from the device.

Your TV is fitted with a USB connection that enables you to view photos or listen to music stored on a USB storage device.

Supported formats	Not-supported formats
MP3	File name exceeding 256 characters
JPEG	Progressive JPEG files
FAT/DOS-formatted memory devices	File names containing a dot character

It is recommended that files to be played back in this unit are recorded under the following specifications:

#### <MP3>

- Sampling frequency : 32kHz or 44.1kHz or 48kHz
- Constant bit rate : 32kbps - 320kbps

#### <JPEG>

- Upper limit : 16Mpixel

#### <MPEG>

- Playable codec : MPEG1, MPEG2
- Maximum size of a video : 1920x1080
- Audio type : AC3, MPEG1 audio layer 3 (MP3), MPEG1 audio layer 2, LPCM

### Note

- A maximum of 1,023 folders or files can be recognized.
- Philips can not be held responsible if your USB storage device is not supported, nor will Philips accept any liability for damage or loss of stored data.
- The USB storage device is not supplied with the TV.
- Do not use an extension cord and USB Hub to connect devices to this unit. Always insert the USB flash memory in to this unit directly.

## Connect a USB storage device

- 1 Turn on the TV.
- 2 Connect the USB storage device to the USB port on the side of your TV.
- 3 Use **▲/▼/◀/▶** to select **[Browse USB]**.
  - Press **OPTIONS** to display the optional menu, then press **OK** to switch between **[List]** and **[Thumbnails]**.



## Disconnect a USB storage device

### Caution

- To avoid damaging the USB storage device always exit the on-screen menu and wait 5 seconds before you remove the USB storage device.

- 1 Press **MENU** to exit the on-screen menu.
- 2 Wait 5 seconds then remove the USB storage device.

## View your picture on a USB storage device

- 1 In the USB content browser, use **▲/▼** to select **[Picture]**.
- 2 Press **▲/▼** to select a file or a folder on the USB storage device.

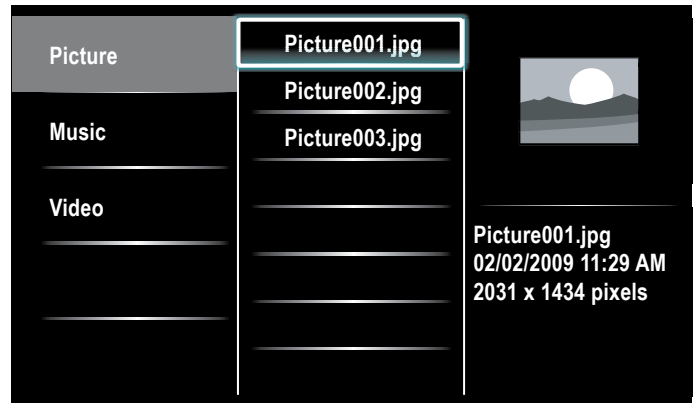

- 3 Press **OK** or **▶||** to start a slideshow of the files.
  - Press **OK** or **▶||** to pause the slide show.
    - ↳ The **||** icon appears.
  - Press **◀◀** or **▶▶** to move between images.
  - Press **BACK** or **■** to stop the slide show.
  - Press **OPTIONS** to display the optional menu, then use **▲/▼** to select the desired item.

Setting items	Description	
Slide time *1	Short	Switches to the next image in 5 seconds.
	Medium	Switches to the next image in 10 seconds.
	Long	Switches to the next image in 15 seconds.
Transitions *1	None	No effect when switching images.
	Dissolve	Overlaps a next image on a current image.
	Wipe right	Pushes a current image out from left.
	Wipe left	Pushes a current image out from right.
	Wipe up	Pushes a current image out from bottom.
	Wipe down	Pushes a current image out from top.
	Box in	A next image comes into the center from out.
	Box out	A next image goes to the out from center.
Rotate *2	0	Displays an image at its original direction.
	90	Rotates an image clockwise by 90 degrees.
	180	Rotates an image clockwise 180 degrees.
	270	Rotates an image clockwise 270 degrees.
Zoom *2	1x	Displays an image at its original size.
	2x	Magnifies a current image as twice.
	4x	Magnifies a current image as fourfold.

\*1 You can set **[Slide time]** and **[Transitions]** when images are in Slide show.

\*2 You can set **[Rotate]** and **[Zoom]** when Slide show is in pause mode.

## Listen to music on a USB storage device

- 1 In the USB content browser, use ▲/▼ to select [Music].
- 2 Press ▲/▼ to select a file or a folder on the USB storage device.

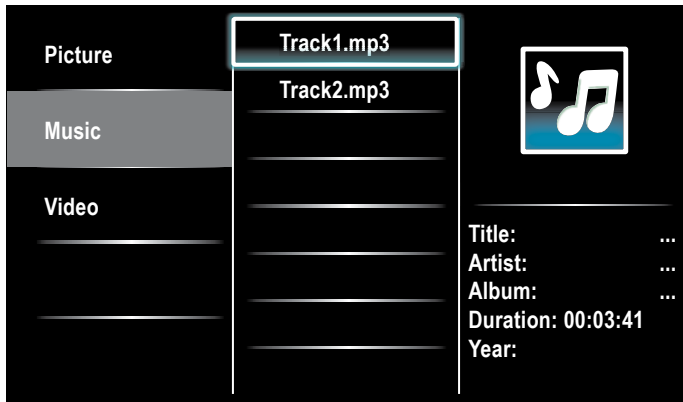

- 3 Press **OK** or **▶||** to play the selected files.
  - Press **OK** or **▶||** to pause, press **OK** or **▶||** again to resume.
  - Press **▶▶** to skip up the next file.
  - Press **◀◀** to skip down the previous file.
  - Press **■** to stop playback.
  - Press **OPTIONS** to display the optional menu, then use ▲/▼ to select the desired item.

Setting items		Description
Repeat	Off	Sets repeat playback to off.
	On	Sets repeat playback for all MP3 files in the current folder.
Shuffle	Off	Sets shuffle playback to off.
	On	Sets shuffle playback for all MP3 files in the current folder.
TV speakers	Off	The sound will not be output from the unit's speakers.
	On	The sound will be output from the unit's speakers.
	Speakers EasyLink	You can control audio output from your connected EasyLink Compliant Devices with VOL +/- by using this unit's remote control.

### Note

- [TV Speakers] will be displayed only when [Master EasyLink] is set to [On]. (See 'EasyLink' on page 29.)

## Watch your Video on a USB storage device

- 1 In the USB content browser, use ▲/▼ to select [Video].
- 2 Press ▲/▼ to select a file or a folder on the USB storage device.

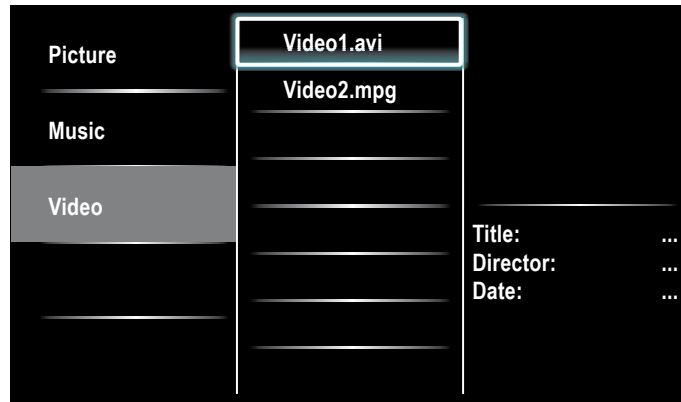

- 3 Press **OK** or **▶||** to play the selected files.
  - Press **OK** or **▶||** to pause, press **OK** or **▶||** again to resume.
  - Press **▶▶** to fast-forward search.
  - Press **◀◀** to fast-backward search.
  - Press **■** to stop playback.
    - ↳ Press **▶||** to resume from the point at which playback was stopped. Press **OK** to play from the beginning of the file at which playback was stopped.
  - Press **OPTIONS** to display the optional menu, then use ▲/▼ to select the desired item.

Setting items		Description
Subtitle	Not available	Displays if no subtitle is available.
	Subtitle Off	Set subtitle to off.
	Subtitle 1-8	Select the desired subtitle if the Video file contains them.
Audio language	Not available	The unit displays if no audio language is available.
	Audio 1-8	Select the desired audio language if the Video file contains them.
TV speakers	Off	The sound will not be output from the unit's speakers.
	On	The sound will be output from the unit's speakers.
	Speakers EasyLink	You can control audio output from your connected EasyLink Compliant Devices with VOL +/- by using this unit's remote control.

### Note

- The resume information will be kept even when the unit is turned off.
- If you play another file while the previously viewed file is being resumed, the resume information of the previously viewed file will be deleted.
- The file or the folder in resume stop mode will be highlighted in gray on [List] or [Thumbnails].

## 7 Install channels

The first time you set up your TV, you are prompted to select a menu language and to install TV and digital radio channels (if available). This chapter provides instructions on how to reinstall and fine-tune channels.

### Selecting your menu language

- 1 Press **MENU** on the remote control and then use **▲/▼/◀/▶** to select **[Setup]** > **[Installation]** > **[Language]**.

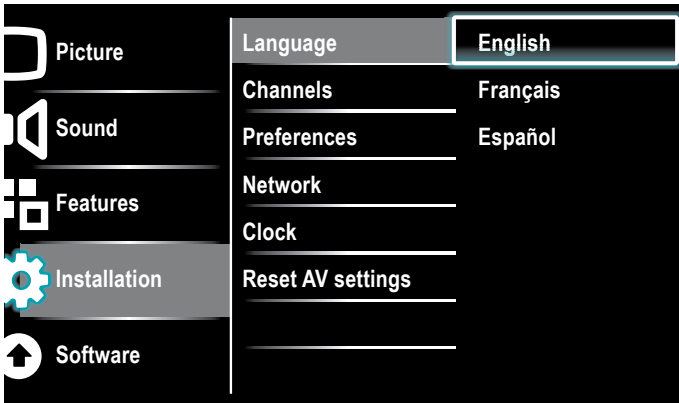

- 2 Select a language and then press **OK** to confirm your choice.
- 3 Press **MENU** to exit.

### Autoprogram

If you switch wires (e.g., between antenna and CATV) or if you move the unit to a different area after the initial setting, you will need to perform autoprogram.

- 1 Press **MENU** on the remote control and then use **▲/▼/◀/▶** to select **[Setup]** > **[Installation]** > **[Channels]** > **[Autoprogram]** > **[Start now]**.

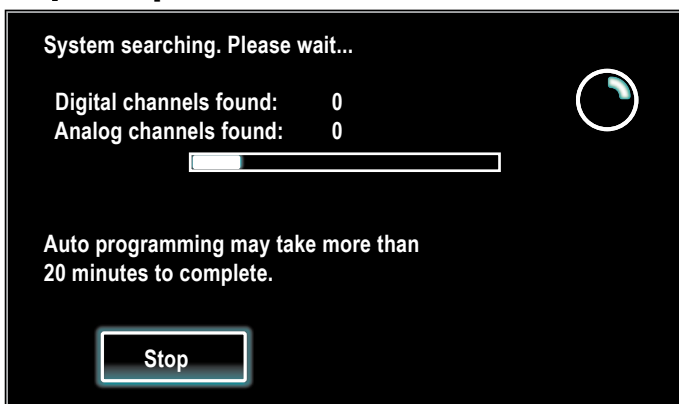

- 2 Press **OK** to start the installation.

If you run **[Autoprogram]** when you have locked channels, a message appears asking to enter your PIN. Enter your PIN in order to complete the installation.

If you have forgotten your PIN, reset it as described in 'Changing your PIN' on page 26.

- When autoprogramming is complete, the lowest memorized channel will be displayed.

- 3 Follow the on-screen instructions to complete the installation.

### Weak channel installation

This function lets you add the channels that were not added by the autoprogram due to the receivable condition at the initial setup.

- 1 Press **MENU** on the remote control and then use **▲/▼/◀/▶** to select **[Setup]** > **[Installation]** > **[Channels]** > **[Weak channel installation]**.
- 2 Use **◀/▶** to select channel input box, then use **▲/▼** to select a channel you want to memorize.
- 3 Use **◀/▶** to select **[Search]**, then press **OK**.
- 4 Display will be changed to **[Store]** from **[Search]** when the channel is found, then press **OK**.
- 5 Press **MENU** to exit.

#### Note

- In most cases, digital channels are not broadcast on the RF channel on which they appear on your TV. To add digital channels you need to know the RF channel on which the digital channel is being broadcast. E.g. If there is a digital channel 9.1 which is being broadcast on RF channel 25, you need to enter 25 while performing a weak channel installation. To find out the RF channel on which a particular digital channel is being broadcast, please contact your local service provider. Installing digital channels using **[Weak channel installation]** might not work for direct cable connections and if the digital signal is too weak for the TV to process.

### Installation mode

- 1 Press **MENU** on the remote control and then use **▲/▼/◀/▶** to select **[Setup]** > **[Installation]** > **[Channels]** > **[Installation mode]**.
- 2 Use **▲/▼** to select, then press **OK**.
- 3 Press **MENU** to exit.

### Uninstall channels

Those channels can still be selected with **the Number buttons**.

- 1 Press **MENU** on the remote control and then use **▲/▼/◀/▶** to select **[Setup]** > **[Installation]** > **[Channels]** > **[Uninstall channels]**.
- 2 Use **▲/▼** to select the channel you want to remove, then press **OK**.
  - You will not be able to select the channel again using **CH +/-**.
  - To reactivate a removed channel, use **▲/▼** and then press **OK**.
- 3 Press **MENU** to exit.

### Return your settings to default values

When you return picture and sound settings to their default values the channel installation settings are not affected.

- 1 Press **MENU** on the remote control and then use **▲/▼/◀/▶** to select **[Setup]** > **[Installation]** > **[Reset AV settings]** > **[Start now]**.
- 2 Press **OK** to reset the picture and sound settings.
- 3 Press **MENU** to exit.

# 8 Update your TV software

Philips continuously tries to improve its products and we strongly recommend that you update the TV software when updates are available. New software can be downloaded from our website at [www.philips.com/support](http://www.philips.com/support) using the model number of your TV (e.g. 55PFL4706) to find information.

## Checking your current software version

- 1 Press **MENU** on the remote control and then use **▲/▼/◀/▶** to select **[Setup] > [Software] > [Software information] > [Select]**.  
↳ The version and a description of the current software is displayed.

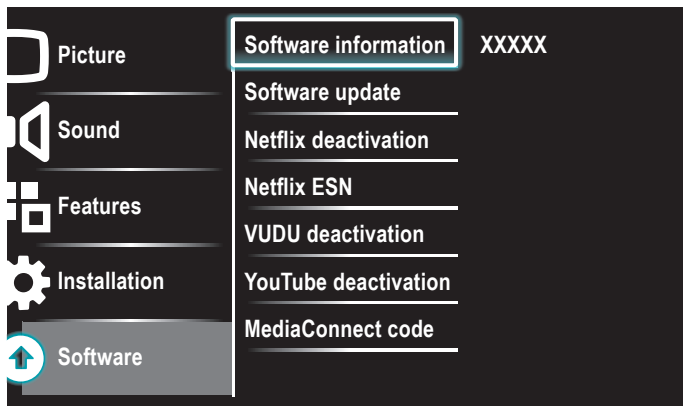

- 2 Press **MENU** to exit.

## Preparing for the software update by USB

You require the following equipment:

- A PC with web browsing capability.
- An archive utility that supports the ZIP-format (e.g. WinZip for Windows or Stuffit for Mac OS).
- An empty clean formatted USB stick.

**Note**

- Only FAT/DOS-formatted portable memory is supported.
- New software can be downloaded from [www.philips.com/support](http://www.philips.com/support)
- Use only software updates that can be found on the Philips web site.

**Warning**

- When the software update is running, don't press any buttons.
- Do not remove the USB storage device during the software update.
- If an error occurs during the update, retry the procedure or contact your dealer.

## Downloading the software

- 1 On your PC, open a web browser and go to [www.philips.com/support](http://www.philips.com/support)
- 2 Find information and software related to your TV and download the latest software update file to your PC.
- 3 Decompress the ZIP-file.
- 4 Copy the update file to the root directory of the USB storage device.

# Updating software

## USB update

You can update the software by using USB storage device.

- 1 If the TV is on, press **⏻ POWER** at the side of the TV.
- 2 Connect your USB storage device with the update file to the USB port on the side of your TV.

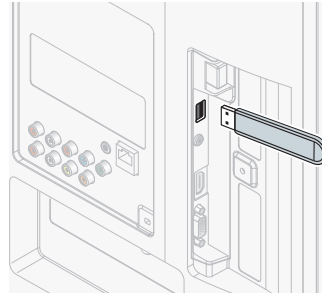

- 3 Switch on the TV.
- 4 Press **MENU** on the remote control and then use **▲/▼/◀/▶** to select **[Setup] > [Software] > [Software update] > [USB]**.
- 5 Use **▲/▼** to select the desired Update file.
- 6 Use **▲/▼** to select **[Yes]**, then press **OK**.
- 7 Read the on-screen instructions and confirm that you want to continue with the installation.



- 8 When the software update is complete, remove the USB storage device.
- 9 Unplug the AC power cord for a few seconds from AC outlet and plug it again.
- 10 Switch on the TV.  
↳ The TV starts up with the new software.

  - The following messages are displayed without starting software update when it doesn't fulfill the update conditions.

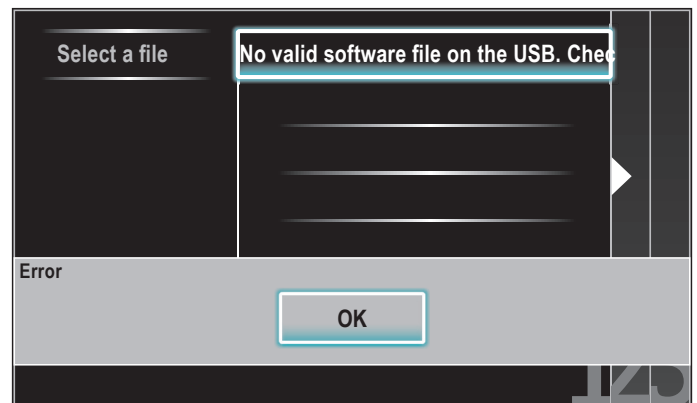

## Network update

You can update the software by connecting the unit to the internet.

- 1 Follow steps 1 to 2 in 'Connection test' on page 30.
- 2 Press **MENU** on the remote control and then use **▲/▼/◀/▶** to select **[Setup] > [Software] > [Software update] > [Network]**.
- 3 Use **◀/▶** to select **[Yes]**, then press **OK**.
  - This unit will then start checking for the latest firmware version.
- 4 Confirmation message will appear. Use **◀/▶** to select **[Yes]**, then press **OK**.
  - The unit will start downloading the latest firmware version.
  - The unit will start updating the firmware version.
  - It may take a while to complete the updating.
- 5 When the software update is complete, press **POWER**  at the side of the TV to make sure the unit goes to standby mode.
- 6 Switch on the TV.
  - ↳ The TV starts up with the new software.

### Note

- In order to update software via the internet, you must connect the unit to the internet and set up necessary settings.
- For the network connection, refer to 'Connecting the TV to the internet using an Ethernet cable' or 'Connecting the TV to the internet using a wireless LAN' on page 41.
- For the network setup, refer to 'Network' on page 30.
- Please do not unplug the AC power cord or Ethernet cable while executing the 'Network update'.
- All settings will remain the same even if you update the software version.
- The version of Netflix will also be updated if newer version of Netflix is available when updating the firmware.

# 9 Connect devices

This section describes how to connect various devices with different connectors and supplements examples provided in the Quick Start Guide.

## Connection overview

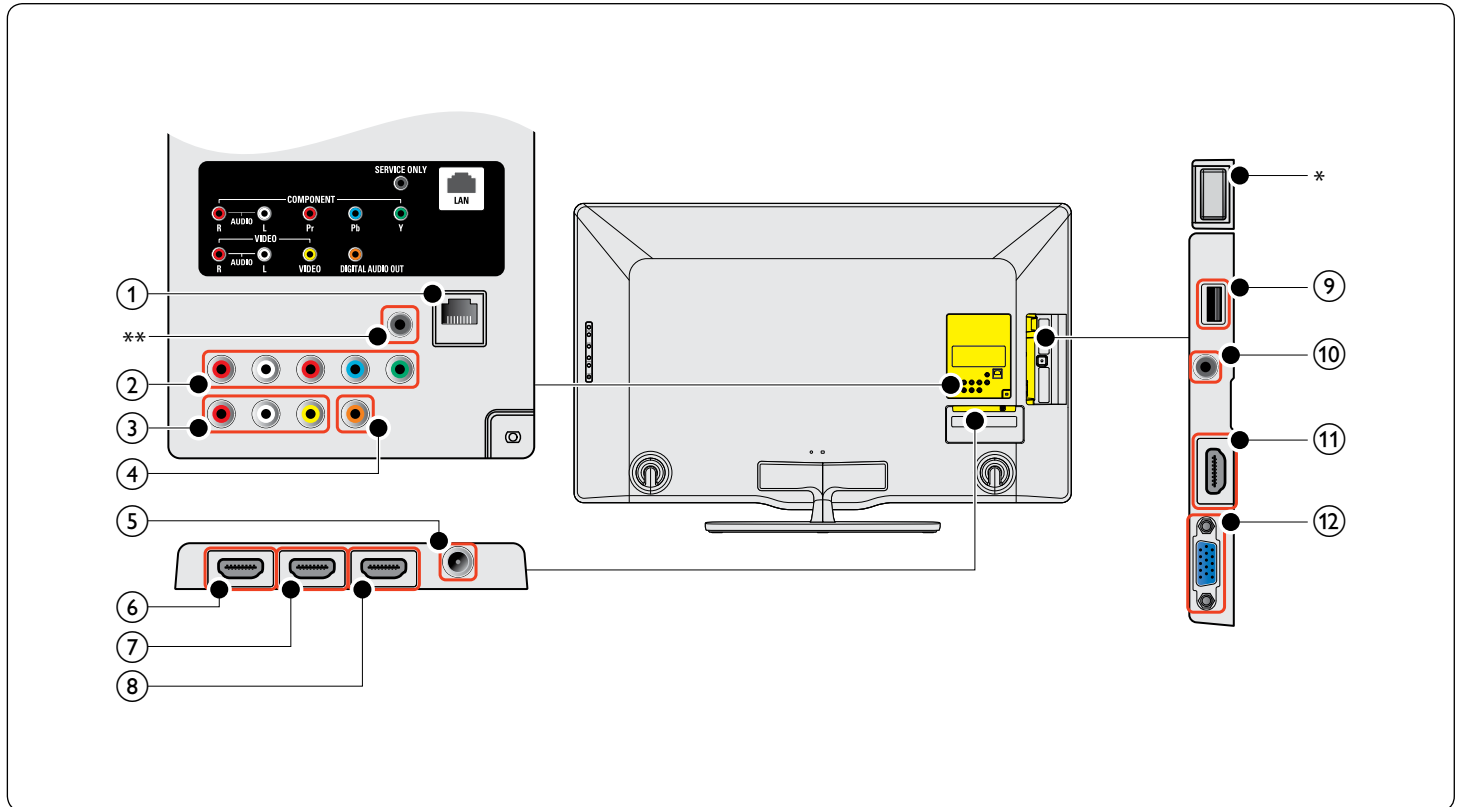

- ① **Ethernet port**  
For internet connection using an Ethernet cable with a RJ-45 connector.
  - ② **Component video and audio input jack**  
Video input from analog devices such as DVD, receiver, game console, etc. This connector is used with audio input.
  - ③ **Composite video and audio input jack**  
Video input for analog devices such as DVD, camcorder, game console, etc. To be used with audio input.
  - ④ **Digital audio output jack**  
Digital audio output to home theaters and other digital audio systems.
  - ⑤ **Antenna input jack**  
Signal input from an antenna, cable or satellite.
  - ⑥ **HDMI 1 input jack**  
First HDMI in connector.  
Digital audio and video input from high definition digital devices such as Blu-ray players.  
In addition to normal HDMI functionality, outputs TV audio to an HDMI ARC-compliant device, such as a home theater system.  
(HDMI 1 only)
  - ⑦ **HDMI 2 input jack**  
Second HDMI in connector.
  - ⑧ **HDMI 3 input jack**  
Third HDMI in connector.
  - ⑨ **USB terminal**  
Data input from USB storage devices only. Do not connect any device to this terminal such as; digital camera, keyboard, mouse, etc.
  - ⑩ **Audio input jack for HDMI 4 and PC**
  - ⑪ **HDMI 4 input jack**  
Fourth HDMI in connector.
  - ⑫ **PC input jack**  
VGA cable connection for PC.
- \* **Wireless LAN (internal)**  
Please make sure that there are no obstacles between the TV and the wireless router. Other devices and wireless routers using the 2.4GHz spectrum might cause interference and dropouts in connection. Refer to the user manual of your wireless router to select the best transmission channel in your usage settings.
- \*\* **service only**  
For use by service personnel only.

**Caution**

- Disconnect the AC power cord before connecting devices.

**Note**

- Do not use an extension cord between the USB flash memory and the unit. Always insert the USB flash memory to this unit directly.
- Different types of connectors may be used to connect a device to your TV, depending on availability and your needs.

## Selecting your connection quality

### HDMI - Highest quality

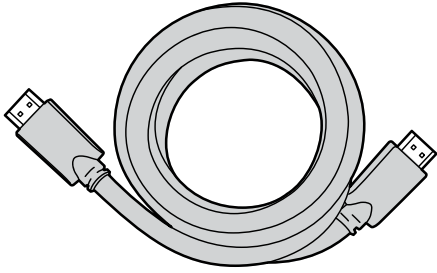

Supports high-definition signals and gives highest picture and sound quality. Video and audio signals are combined in one cable. You must use HDMI for full high-definition video and to enable Philips EasyLink.

#### Note

- Philips HDMI supports HDCP (High-bandwidth Digital Contents Protection). HDCP is a form of Digital Rights Management that protects high definition content in DVD or Blu-ray Discs.
- The HDMI ARC connector on the TV features HDMI ARC functionality. This allows output of TV audio to an HDMI ARC-compliant device.

### Component (Y Pb Pr) - High quality

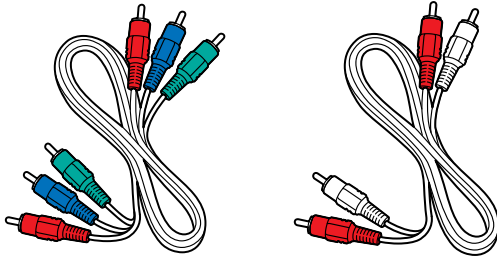

Component video cable (red/green/blue) and audio L/R cable (red/white). Supports high-definition signals but gives lower picture quality than HDMI. Component cables combine a red/green/blue video cable with a red/white audio L/R cable. Match the cable colors when you connect to the TV.

### Composite - Basic quality

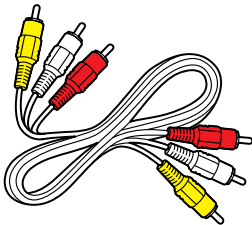

Composite video/audio cable (yellow/red/white)  
For analog connections. Composite cables usually combine a yellow video cable with a red/white audio L/R cable. Match the audio cable colors when you connect to the TV.

## Connecting your devices

This section describes how to connect a selection of devices with different connectors. Different types of connectors can be used to connect a device to your TV. The following sections describe examples only, other configurations are possible.

### Connecting a set-top box, Blu-ray Disc player and HD game console via HDMI

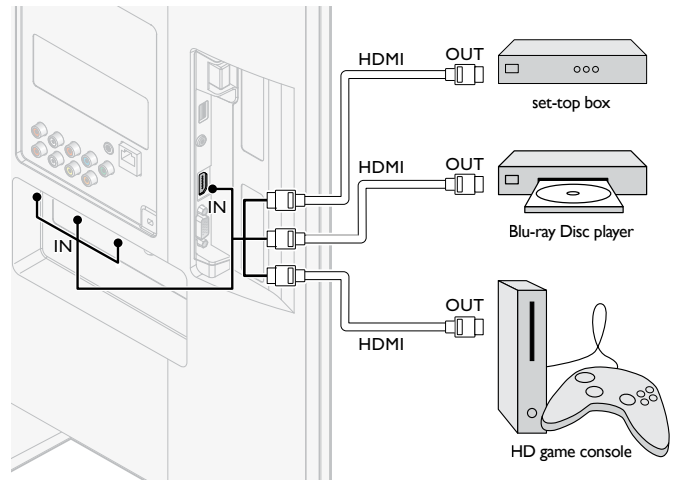

### Connecting a DVD player/recorder via HDMI-DVI and analog audio

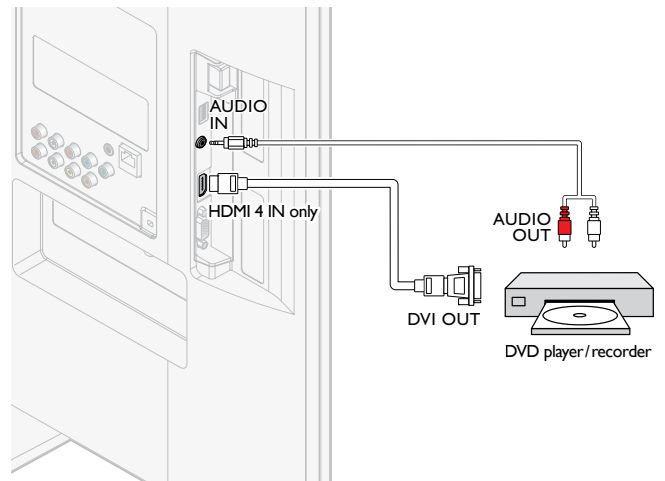



## Connecting a digital home theater amplifier using HDMI ARC

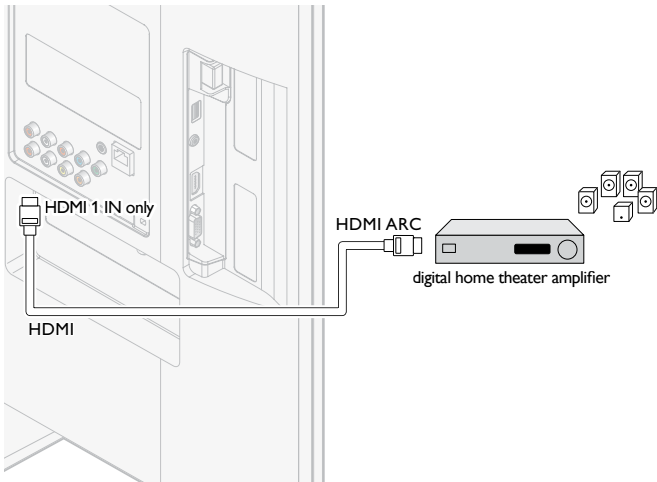

### Note

- The HDMI 1 connector is HDMI Audio Return Channel (ARC) compliant. Use it to output digital audio to an HDMI Home Theater System.

## Connecting a set-top box, DVD player/recorder via component video connectors (YPbPr) and analog audio

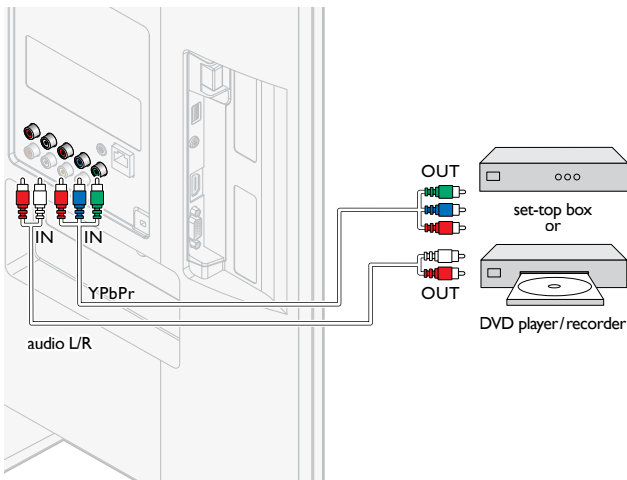

### Note

- When you connect cables, match the cable colors to the connectors on the TV.

## Connecting a set-top box, DVD recorder via composite connectors and analog audio

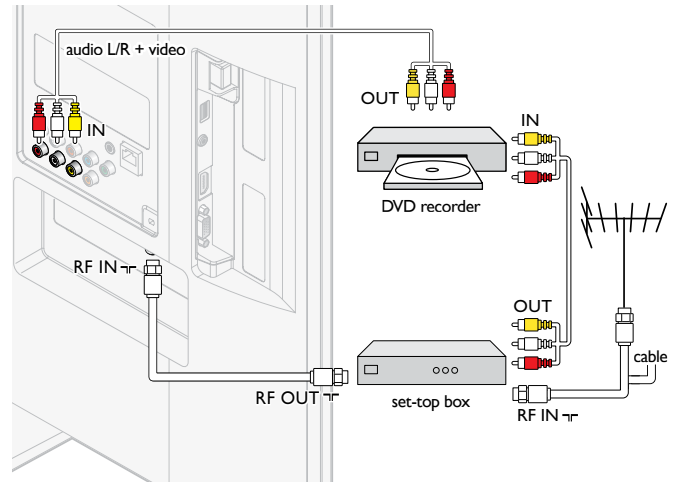

Do not place your recorder too close to the screen because some recorders can be susceptible to signals.

### Note

- Only the left loudspeaker reproduces sound for mono equipment. Use a mono to stereo adapter (not supplied) for sound reproduction via all internal loudspeakers.
- When you connect cables, match the cable colors to the connectors on the TV.

## Connecting a set-top box via a composite connector and analog audio

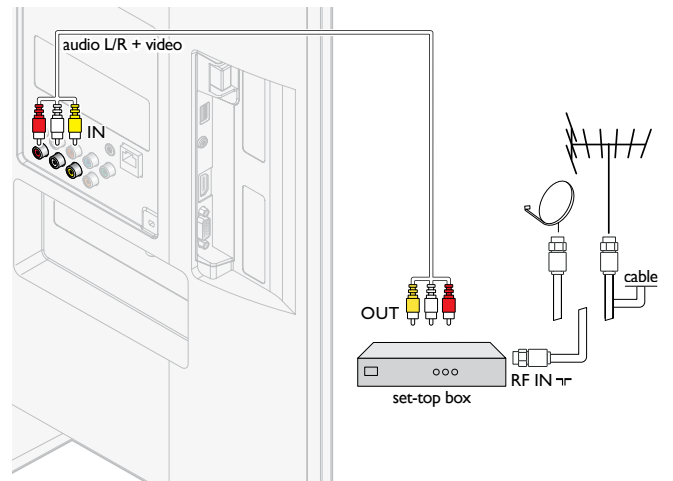

### Note

- Only the left loudspeaker reproduces sound for mono equipment. Use a mono to stereo adapter (not supplied) for sound reproduction via all internal loudspeakers.
- When you connect cables, match the cable colors to the connectors on the TV.

## Connecting the TV to the internet using an Ethernet cable

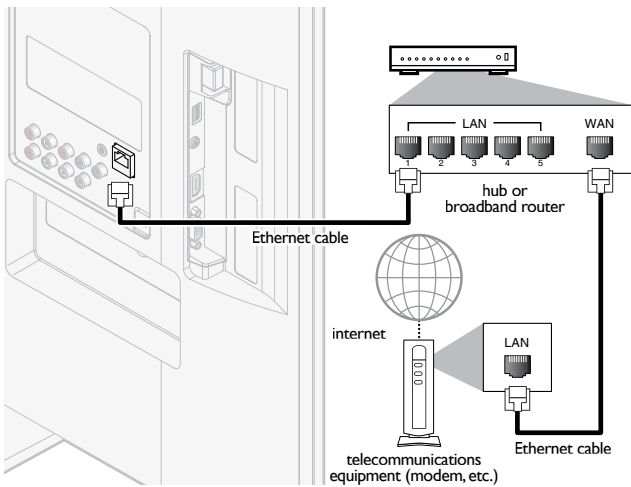

### Note

- Please purchase shielded Ethernet cables at your local store and use them when you connect to network equipment.
- After connecting an Ethernet cable, set up necessary network settings. (For the network setup, refer to 'Network' on page 30.)
- Do not insert any cable other than an Ethernet cable to the Ethernet port to avoid damaging the unit.
- If your telecommunications equipment (modem, etc.) does not have broadband router functions, connect a broadband router.
- If your telecommunications equipment (modem, etc.) has broadband router functions but there is no vacant port, use a hub.
- For a broadband router, use a router which supports 10BASE-T/100BASE-TX.
- Do not connect your PC directly to the Ethernet port of this unit.

## Connecting a digital home theater amplifier using a digital audio coaxial cable

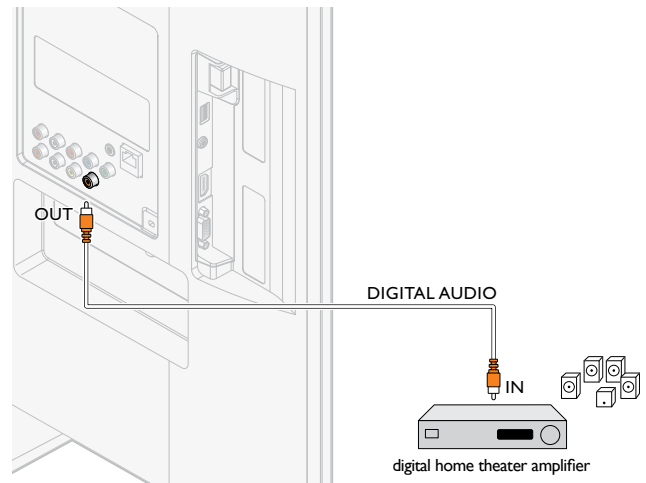

### Note

- Due to Copyright restrictions, the broadcaster may choose to mute PCM audio over Digital Audio Output for certain channels, shows or segments during the broadcast.

## Connecting the TV to the internet using a wireless LAN

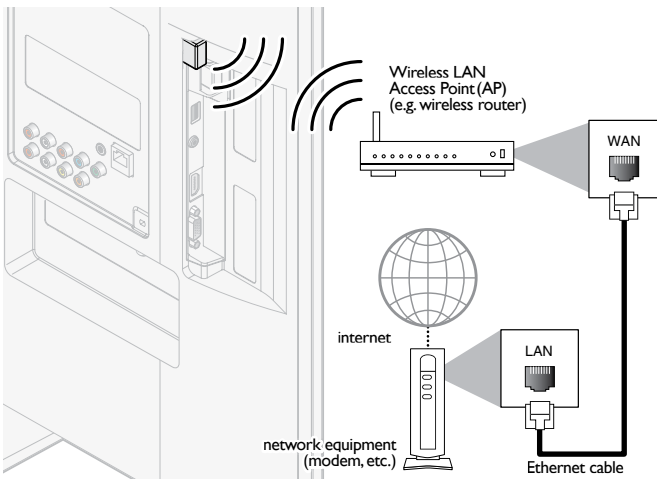

### Note

- After you made the wireless connection, set up necessary network settings. (For the network setup, refer to 'Network' on page 30.)
- Use a Wireless LAN Access Point (AP) (e.g. wireless router) which supports IEEE 802.11 b/g/n. (n is recommended for stable operation of the wireless network.)
- This unit does not support Ad-hoc mode.
- Other radio devices or obstacles may cause interference to the wireless network connection.

## Connecting a PC

If you connect a PC with a VGA connector at the back.

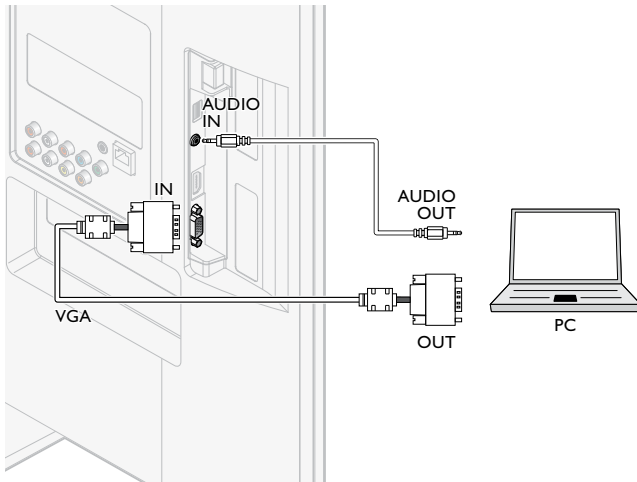

If you connect a PC with a HDMI-DVI connector:

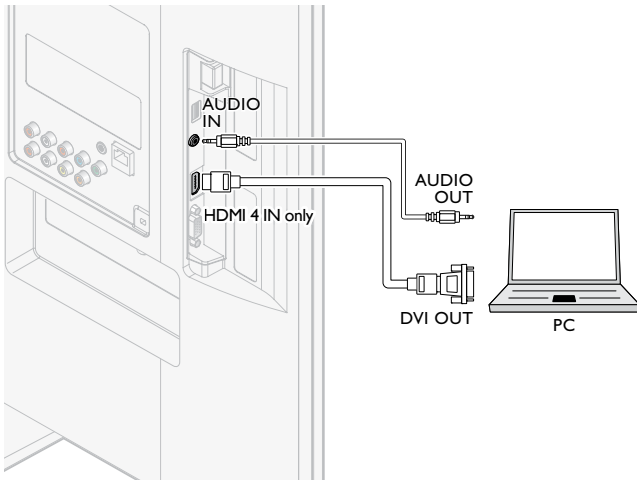

If you connect a PC with an HDMI or Display Port (HDMI-Display Port conversion cable) connector:

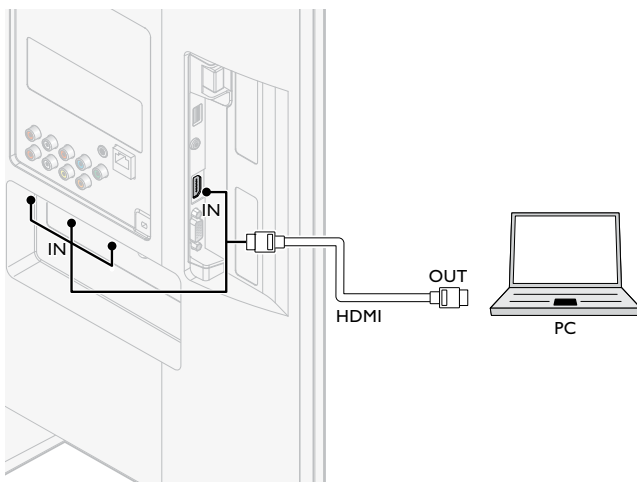

## Add devices

After connecting devices, assign the device attached to each connector. This allows you to easily identify devices connected to your TV.

- 1 Press **MENU** on the remote control and then use **▲/▼/◀/▶** to select **[Add new devices]**.
- 2 Use **◀/▶** to select **[Start]**, then press **OK**.
- 3 Use **▲/▼** to select a device and press **OK**.
- 4 Use **▲/▼** to select the connector your device is connected to and press **OK**.
- 5 If there is video and audio output, press **OK**.

Repeat the procedure until all devices are correctly assigned to connectors.

## Remove devices

If a device is no longer connected to the TV, remove it from the home menu.

- 1 Press **MENU** on the remote control.
- 2 Use **▲/▼/◀/▶** to select a device to remove.
- 3 Press **OPTIONS**.
- 4 Use **▲/▼** to select **[Remove device]**, then press **OK**.
- 5 Use **◀/▶** to select **[OK]**, then press **OK**.

### Note

#### HDMI/DisplayPort Audio Specifics:

- To hear your PC audio from the TV speakers, make sure the default playback device is the HDMI Audio Device and not your computer speakers/soundcard.
- The HDMI Audio device is a child device on your graphics card, which means your graphics card video & HDMI audio drivers need to be up to date and bug free (we have seen many cases where having a bad video driver resulted in no HDMI audio).
- Make the TV the only output device. Sometimes if you extend your desktop to the TV or duplicate the desktop with another monitor or your laptop screen, Windows does not make the HDMI audio devices as the default audio playback device.

# 10 Troubleshooting

Problem	Possible cause and solution
No power or indicator light.	The TV is not connected to the power. Press <b>POWER</b> at the side of the TV or on the remote control. Ensure that the AC power cord is connected tightly to the TV power connector and to the power socket outlet. Remove the AC power cord from the power socket outlet, wait 60 seconds and reconnect the AC power cord. Connect the TV to a different power socket outlet.
No picture or sound is detected from the device using HDMI 1-4 input jack.	HDCP authentication fail. Ensure that your HDMI cable is certified. Press <b>SOURCE</b> on the remote control to switch to another source and then switch back to the HDMI source. Reset the accessory device and the TV. Turn on the TV. Select the HDMI channel. Turn on the accessory device. While the TV and the accessory device are powered on, unplug either end of the HDMI cable and then reinsert the cable.
No sound is detected from the PC using PC input jack.	An audio cable is not connected. Connect an audio cable to the PC/HDMI 4 AUDIO IN on the TV. Press <b>SOURCE</b> on the remote control, and select the PC source.
No picture or sound is detected from the PC using HDMI 4 input jack.	An incorrect HDMI input jack is connected or an audio cable is not connected. Connect a HDMI-DVI cable to the HDMI 4 input jack on the TV. Connect an audio cable to the PC/HDMI 4 AUDIO IN on the TV. Press <b>SOURCE</b> on the remote control, and select the HDMI 4 source.
TV does not respond to the remote control.	Batteries are installed incorrectly, or low battery power. Ensure that you are using the TV remote control. Ensure that the batteries are inserted correctly and do not need to be replaced. Remove the AC power cord from the power socket outlet, wait 60 seconds and reconnect the AC power cord.
The picture is distorted, stretched out, or has black bars on the side or top.	Broadcast video format. Press <b>FORMAT</b> on the remote control to select the best picture format. For some accessory devices, the picture format must be set in the accessory device.
The picture is mostly red and green, or the picture misses red when connected to an accessory device via component cables.	Insecure/incorrect connection. Ensure all the connections are made according to the color code. Push the component cables all the way into the YPbPr sockets on the TV.
No picture or sound.	No picture or sound - ensure you have selected the correct channel. Incomplete channel installation. If the TV receives channels via an AV connection, set the TV to the correct source input. If the TV is connected directly to the wall via a coaxial connection, perform the autoprogram again.
No sound on the TV loudspeaker.	Volume level is set to zero - increase the volume. Sound is muted - press <b>MUTE</b> on the remote control. Audio cable is not connected - for AV connection, ensure that the Audio L/R cable is connected as described in Connecting your devices. (See 'Connecting your devices' on page 39.) If you use a component cable, ensure that you have not crossed the red audio cable with the red video cable. Audio output setting for the accessory device is incorrect. For HDMI connections, some accessory devices have an HDMI audio output setting that must be turned on for HDMI to HDMI connections. Check if <b>[Sound] &gt; [TV Speakers] &gt; [Off]</b> is set to <b>[On]</b> . No sound will be output when <b>[TV Speakers]</b> is set to <b>[Off]</b> .
Bad picture quality with a coaxial connection.	Standard definition channels are not as clear as high definition channels - connect the devices via component or HDMI cables.
Cannot control your TV and connected devices with one remote control.	Confirm that the connected devices are EasyLink compliant and are connected to your TV via an HDMI cable. Not all brands of devices such as Blu-ray Disc players use the same system as Philips EasyLink. Other brands might not work with Philips EasyLink.
Folder or files stored on DLNA home media server are not displayed in the file list or cannot be played back.	Check the setting on your home media server. (Refer to the user manual of the home media server.) Check the network connection and settings.
Cannot use Netflix feature.	Netflix is available only in the United States. Check if the network connection is properly made. Visit <a href="http://www.netflix.com/Philips">www.netflix.com/Philips</a> on your PC and become a Netflix member.
Cannot add movies or TV episodes to the Instant Queue.	Visit <a href="http://www.netflix.com">www.netflix.com</a> on your PC.
Cannot use VUDU feature.	VUDU is available only in the United States. Check if the network connection is properly made.
Cannot rent or buy movies/TV episodes on VUDU.	You need to activate the VUDU account. (Refer to page 17.) Log into your account at <a href="http://my.vudu.com">http://my.vudu.com</a> and check your payment information.
The picture quality of streaming movie (Netflix, Film Fresh, Blockbuster or VUDU) is poor.	Check the speed of your internet connection. You need speeds of at least 8 Mbps to this player for high quality uninterrupted playback.

Streaming movie (Netflix, Film Fresh, Blockbuster or VUDU) often stops or starts buffering during playback.	Contact your internet service provider to troubleshoot your internet connection for speed and line quality. Consistent line quality and speed are very important for internet video playback.
Even though the speed of the internet connection improves during playback, the picture quality of Netflix streaming movie does not improve.	The picture quality does not change during playback. The picture quality differs depending on the speed of internet connection at the time of loading.
Cannot use Film Fresh/Blockbuster feature.	Film Fresh/Blockbuster is available only in the United States. Check if the network connection is properly made. Visit <a href="http://filmfresh.roxionow.com/">http://filmfresh.roxionow.com/</a> (Film Fresh) or <a href="http://www.blockbuster.com">http://www.blockbuster.com</a> (Blockbuster) on your PC and create an account.
Cannot use Pandora feature.	Check if the network connection is properly made. Pandora is available only in the United States. You must create a Pandora account and activate this unit. (Refer to 'Activating Pandora' on page 19.)
The audio of internet radio station interrupted.	vTuner server, station or the internet connection is busy. The bit rate of the station is high.
Cannot connect to the network.	Check if the Ethernet cable connection is properly made. Turn on the modem or broadband router. Check the network settings. Check if the broadband router and/or modem is correctly connected.
Cannot connect to the network while my PC is connected to the network.	Check the content of your internet service contract to see if your internet Service Provider prevents multiple terminals connecting at the same time.
Cannot play back internet radio.	Check if the network connection is properly made. Check the firewall setting of the modem or router. For some stations, playback is not available on this unit.
The quality of the internet radio audio is poor or noise occurs during playback of internet station.	The bit rate of the station is low.
Cannot use the wireless connection.	Check if the Wireless LAN Access Point (AP) (e.g. wireless router) is oriented properly or not placed too close between them. Once you have activated the wireless connection please wait 30 seconds for the connection to be established after turning on the unit, before trying to access network features such as Net.TV.
Cannot get into the PC's screen even the Philips Wireless MediaConnect is launched.	The start up screen (PHILIPS logo with spinning circle) keep displaying until the unit found the PC that is running Philips Wireless MediaConnect. Make sure if the network connection is connected properly. Check if your PC runs Philips Wireless MediaConnect. Make sure your TV and PC are connected on the same network.
I have a 1.8GHz CPU but MediaConnect does not work on my PC.	For smooth operation of your PC while Philips MediaConnect is running you need a mainstream dual core processor from Intel or AMD. Intel: Core2Duo or Core i3/5/7 @ 1.8GHz or higher. AMD: Athlon II X2, Turion II Dual-Core or Phenom X2 @ 2GHz or higher.

## Downloading an electronic copy

To obtain an electronic copy of this manual:

- 1 Point your browser to [www.philips.com/support](http://www.philips.com/support)
- 2 Choose your country of location.
- 3 Enter the model number or a keyword in the "Find your product" field. Alternatively, you can browse the catalog.
- 4 Click the description or model.
- 5 Under Product support, click "User manuals".

## Contact us

If you cannot resolve your problem, refer to the FAQ for this TV at [www.philips.com/support](http://www.philips.com/support)

If the problem remains unresolved, contact the Customer Support Center in your country.



### Warning

- Do not attempt to repair the TV yourself. This may cause severe injury, irreparable damage to your TV or void your warranty.



### Note

- Please have available your TV model and serial number before contacting us. These numbers are available on the back and side of your TV, as well as on the packaging.

# 11 Specifications

## Note

- Specifications are subject to change without prior notice.

### Picture enhancement

Type:	55PFL4706:1080p 120Hz 46PFL4706, 40PFL4706:1080p 60Hz
Aspect ratio:	16:9
Viewing angles:	178° (V) by 178° (H)
Built-in digital tuner:	ATSC

### Sound enhancement

Mono/Stereo:	Mono, Stereo, SRS TruSurround HD
Power output (RMS watts):	20 W
Equalizer:	5 band

### Ease of use

Video modes:	Automatic, 4:3, Movie Expand 14:9, Movie Expand 16:9, Super Zoom, Wide Screen, Unscaled
PC input:	via VGA, HDMI
Photo slide show:	Yes (jpeg files only)
MP3 playback:	Yes (mp3 files only)
Video playback:	Yes (MPEG1/2)

### Connections

Component video input with audio L/R:	1 Supporting video signals: 480i/p, 720p, 1080i 60Hz, 1080p 24/30/60Hz
Composite video input with audio L/R:	1
HDMI:	4 Supporting video signals: 480i/p, 720p, 1080i 60Hz, 1080p 24/30/60Hz PC input: up to 1920×1080 60Hz HDMI ARC (HDMI 1 only)
3.5mm stereo miniplug shared use for HDMI 4 and PC input:	1
PC input:	1 up to 1920×1080 60Hz
Digital audio output:	1 Supporting Dolby Digital and PCM
USB:	1
Wireless LAN:	Supporting wireless standards: IEEE 802.11 b/g/n (2.4GHz)
Ethernet port:	1

### Power

Power requirements:	120V~ AC +/- 10%, 60Hz +/- 0.5%
---------------------	---------------------------------

## LIMITED WARRANTY ONE (1) YEAR

### WARRANTY COVERAGE:

This warranty obligation is limited to the terms as set forth below.

### WHO IS COVERED:

This product warranty is issued to the original purchaser or the person receiving the product as a gift against defects in materials and workmanship as based on the date of original purchase ("Warranty Period") from an Authorized Dealer. The original sales receipt showing the product name and the purchase date from an authorized retailer is considered such proof.

### WHAT IS COVERED:

This warranty covers new products if a defect in material or workmanship occurs and a valid claim is received within the Warranty Period. At its option, the company will either (1) repair the product at no charge, using new or refurbished replacement parts, or (2) exchange the product with a product that is new or which has been manufactured from new, or serviceable used parts and is at least functionally equivalent or most comparable to the original product in current inventory, or (3) refund the original purchase price of the product.

Replacement products or parts provided under this warranty are covered against defects in materials and workmanship from the date of the replacement or repair for ninety (90) days or for the remaining portion of the original product's warranty, whichever provides longer coverage for you. When a product or part is exchanged, any replacement item becomes your property and the replaced item becomes company property. When a refund is given, your product becomes company property.

Note: Any product sold and identified as refurbished or renewed carries a ninety (90) day limited warranty.

Replacement product can only be sent if all warranty requirements are met. Failure to follow all requirements can result in delay.

### WHAT IS NOT COVERED - EXCLUSIONS AND LIMITATIONS:

This Limited Warranty applies only to new company manufactured products that can be identified by the trademark, trade name, or logo affixed to it. This Limited Warranty does not apply to any hardware product or any software, even if packaged or sold with the product, as manufacturers, suppliers, or publishers may provide a separate warranty for their own products packaged with the bundled product.

The company is not liable for any damage to or loss of any programs, data, or other information stored on any media contained within the product, or other additional product or part not covered by this warranty. Recovery or reinstallation of programs, data or other information is not covered under this Limited Warranty.

This warranty does not apply (a) to damage caused by accident, abuse, misuse, neglect, misapplication, or non-supplied product, (b) to damage caused by service performed by anyone other than company approved Authorized Service Location, (c) to a product

or a part that has been modified without written company permission, or (d) if any serial number has been removed or defaced, or (e) product, accessories or consumables sold "AS IS" without warranty of any kind by including refurbished product sold "AS IS" by some retailers.

This Limited Warranty does not cover:

- Shipping charges to return defective product.
- Labor charges for installation or setup of the product, adjustment of customer controls on the product, and installation or repair of antenna/signal source systems outside of the product.
- Product repair and/or part replacement because of improper installation or maintenance, connections to improper voltage supply, power line surge, lightning damage, retained images or screen markings resulting from viewing fixed stationary content for extended periods, product cosmetic appearance items due to normal wear and tear, unauthorized repair or other cause not within the control of the company.
- Damage or claims for products not being available for use, or for lost data or lost software.
- Damage from mishandled shipments or transit accidents when returning product.
- A product that requires modification or adaptation to enable it to operate in any country other than the country for which it was designed, manufactured, approved and/or authorized, or repair of products damaged by these modifications.
- A product used for commercial or institutional purposes (including but not limited to rental purposes).
- Product lost in shipment and no signature verification receipt can be provided.
- Failure to operate per Owner's Manual.

### TO OBTAIN ASSISTANCE...

Contact the Customer Care Center at:  
1-866-309-0841

REPAIR OR REPLACEMENT AS PROVIDED UNDER THIS WARRANTY IS THE EXCLUSIVE REMEDY FOR THE CONSUMER, WITH THE ISSUING COMPANY NOT LIABLE FOR ANY INCIDENTAL OR CONSEQUENTIAL DAMAGES FOR BREACH OF ANY EXPRESS OR IMPLIED WARRANTY ON THIS PRODUCT. EXCEPT TO THE EXTENT PROHIBITED BY APPLICABLE LAW, ANY IMPLIED WARRANTY OF MERCHANTABILITY OR FITNESS FOR A PARTICULAR PURPOSE ON THIS PRODUCT IS LIMITED IN DURATION TO THE DURATION OF THIS WARRANTY.

Some states do not allow the exclusions or limitation of incidental or consequential damages, or allow limitations on how long an implied warranty lasts, so the above limitations or exclusions may not apply to you.

*This warranty gives you specific legal rights. You may have other rights which vary from state/province to state/province.*

# 13 Index

## A

Antenna, connect	9
Audio	24
Audio setting	24
Auto mode	24
Auto TV on	29
Auto volume leveling	24

## B

Blockbuster	17
-------------	----

## C

<b>Cables</b>	
component	39
composite	39
connection quality	39
HDMI	39
manage cables	10
YPbPr	39
<b>Channels</b>	
install	35
lock	27
<b>Child lock</b>	
channel lock	27
PIN	26
ratings lock	26, 27, 28
<b>Clock</b>	25
<b>Closed caption</b>	25, 26
<b>Cloud TV</b>	17
<b>Connections</b>	9, 38, 39
<b>Controls</b>	6
<b>Customer support service</b>	5

## D

Device List	29
Device lock	14

## E

EasyLink	29
ENERGY STAR®	4, 11
Environmental care	5
Equalizer	24

## F

FAV	24, 25
Film Fresh	17

## H

Home mode	11, 30
-----------	--------

## I

Initial setup	11
---------------	----

## L

Location (Retail store or Home)	11, 30
---------------------------------	--------

## M

Master EasyLink	29
Mounting stand onto TV	8

## N

Netflix	17
Network	30

## P

Pandora	19, 20
PC	22
Philips Wireless MediaConnect	15
Picture format	23
Picture settings	22

## R

Ratings	26, 27, 28
RC key forwarding	14, 29
<b>Remote control</b>	
insert batteries	8
overview	6, 7
<b>Retail store mode</b>	11, 30

## S

Settings assistant	11, 22
Signal quality	39
Sleeptimer	26
<b>Software</b>	
update	36
version	36
<b>Speakers EasyLink</b>	24, 34
<b>Specifications</b>	44
<b>Standby</b>	6, 12

## T

<b>Troubleshooting</b>	43
<b>TV</b>	
as PC monitor	23, 24, 42
connections	9, 38, 39
controls	6
menu	14
position	8
remote control	6, 7, 8
screen care	5
software	36
switch channels	12
switch on	11, 12
TV Speakers	24
<b>Twitter</b>	20

## U

USB	33, 34
-----	--------

## V

<b>Volume</b>	
adjust	13
auto volume leveling	24
mute	13
<b>vTuner</b>	17
<b>VUDU</b>	17

## W

Warranty	45
Wireless LAN	30, 41

## Y

YPbPr	39
-------	----

# License

This section describes software license used for this product.

This product uses some open source software:

GPL software: linux, gcc, binutils, busybox, dhcpcd

LGPL software: directfb, glibc, Qt, LITE

BSD: WPA Supplicant

MIT: expat, lua, lua-xmlreader, lua-slnrcrypto, libxml2, c-ares

Free Type, LibJPEG, Open SSL, JSON\_Parser, gSOAP, libcurl, Open GL

---

## GPL

The GNU General Public License (GPL)

Version 2, June 1991

Copyright (C) 1989, 1991 Free Software Foundation, Inc. 59 Temple Place, Suite 330, Boston, MA 02111-1307 USA

Everyone is permitted to copy and distribute verbatim copies of this license document, but changing it is not allowed.

### Preamble

The licenses for most software are designed to take away your freedom to share and change it. By contrast, the GNU General Public License is intended to guarantee your freedom to share and change free software—to make sure the software is free for all its users. This General Public License applies to most of the Free Software Foundation's software and to any other program whose authors commit to using it. (Some other Free Software Foundation software is covered by the GNU Library General Public License instead.) You can apply it to your programs, too.

When we speak of free software, we are referring to freedom, not price. Our General Public Licenses are designed to make sure that you have the freedom to distribute copies of free software (and charge for this service if you wish), that you receive source code or can get it if you want it, that you can change the software or use pieces of it in new free programs; and that you know you can do these things.

To protect your rights, we need to make restrictions that forbid anyone to deny you these rights or to ask you to surrender the rights. These restrictions translate to certain responsibilities for you if you distribute copies of the software, or if you modify it.

For example, if you distribute copies of such a program, whether gratis or for a fee, you must give the recipients all the rights that you have. You must make sure that they, too, receive or can get the source code. And you must show them these terms so they know their rights.

We protect your rights with two steps: (1) copyright the software, and (2) offer you this license which gives you legal permission to copy, distribute and/or modify the software.

Also, for each author's protection and ours, we want to make certain that everyone understands that there is no warranty for this free software. If the software is modified by someone else and passed on, we want its recipients to know that what they have is not the original, so that any problems introduced by others will not reflect on the original authors' reputations.

Finally, any free program is threatened constantly by software patents. We wish to avoid the danger that redistributors of a free program will individually obtain patent licenses, in effect making the program proprietary. To prevent this, we have made it clear that any patent must be licensed for everyone's free use or not licensed at all.

The precise terms and conditions for copying, distribution and modification follow.

### TERMS AND CONDITIONS FOR COPYING, DISTRIBUTION AND MODIFICATION

0. This License applies to any program or other work which contains a notice placed by the copyright holder saying it may be distributed under the terms of this General Public License. The "Program", below, refers to any such program or work, and a "work based on the Program" means either the Program or any derivative work under copyright law; that is to say, a work containing the Program or a portion of it, either verbatim or with modifications and/or translated into another language. (Hereinafter, translation is included without limitation in the term "modification".) Each licensee is addressed as "you".

Activities other than copying, distribution and modification are not covered by this License; they are outside its scope. The act of running the Program is not restricted, and the output from the Program is covered only if its contents constitute a work based on the Program (independent of having been made by running the Program). Whether that is true depends on what the Program does.

1. You may copy and distribute verbatim copies of the Program's source code as you receive it, in any medium, provided that you conspicuously and appropriately publish on each copy an appropriate copyright notice and disclaimer of warranty; keep intact all the notices that refer to this License and to the absence of any warranty; and give any other recipients of the Program a copy of this License along with the Program.

You may charge a fee for the physical act of transferring a copy, and you may at your option offer warranty protection in exchange for a fee.

2. You may modify your copy or copies of the Program or any portion of it, thus forming a work based on the Program, and copy and distribute such modifications or work under the terms of Section 1 above, provided that you also meet all of these conditions:

a) You must cause the modified files to carry prominent notices stating that you changed the files and the date of any change.

b) You must cause any work that you distribute or publish, that in whole or in part contains or is derived from the Program or any part thereof, to be licensed as a whole at no charge to all third parties under the terms of this License.

c) If the modified program normally reads commands interactively when run, you must cause it, when started running for such interactive use in the most ordinary way, to print or display an announcement including an appropriate copyright notice and a notice that there is no warranty (or else, saying that you provide a warranty) and that users may redistribute the program under these conditions, and telling the user how to view a copy of this License. (Exception: if the Program itself is interactive but does not normally print such an announcement, your work based on the Program is not required to print an announcement.)

These requirements apply to the modified work as a whole. If identifiable sections of that work are not derived from the Program, and can be reasonably considered independent and separate works in themselves, then this License, and its terms, do not apply to those sections when you distribute them as separate works. But when you distribute the same sections as part of a whole which is a work based on the Program, the distribution of the whole must be on the terms of this License, whose permissions for other licensees extend to the entire whole, and thus to each and every part regardless of who wrote it.

Thus, it is not the intent of this section to claim rights or contest your rights to work written entirely by you; rather, the intent is to exercise the right to control the distribution of derivative or collective works based on the Program.

In addition, mere aggregation of another work not based on the Program with the Program (or with a work based on the Program) on a volume of a storage or distribution medium does not bring the other work under the scope of this License.

3. You may copy and distribute the Program (or a work based on it, under Section 2) in object code or executable form under the terms of Sections 1 and 2 above provided that you also do one of the following:

a) Accompany it with the complete corresponding machine-readable source code, which must be distributed under the terms of Sections 1 and 2 above on a medium customarily used for software interchange; or,

b) Accompany it with a written offer, valid for at least three years, to give any third party, for a charge no more than your cost of physically performing source distribution, a complete machine-readable copy of the corresponding source code, to be distributed under the terms of Sections 1 and 2 above on a medium customarily used for software interchange; or,

c) Accompany it with the information you received as to the offer to distribute corresponding source code. (This alternative is allowed only for noncommercial distribution and only if you received the program in object code or executable form with such an offer, in accord with Subsection b above.)

The source code for a work means the preferred form of the work for making modifications to it. For an executable work, complete source code means all the source code for all modules it contains, plus any associated interface definition files, plus the scripts used to control compilation and installation of the executable. However, as a special exception, the source code distributed need not include anything that is normally distributed (in either source or binary form) with the major components (compiler, kernel, and so on) of the operating system on which the executable runs, unless that component itself accompanies the executable.

If distribution of executable or object code is made by offering access to copy from a designated place, then offering equivalent access to copy the source code from the same place counts as distribution of the source code, even though third parties are not compelled to copy the source along with the object code.

4. You may not copy, modify, sublicense, or distribute the Program except as expressly provided under this License. Any attempt otherwise to copy, modify, sublicense or distribute the Program is void, and will automatically terminate your rights under this License. However, parties who have received copies, or rights, from you under this License will not have their licenses terminated so long as such parties remain in full compliance.

5. You are not required to accept this License, since you have not signed it. However, nothing else grants you permission to modify or distribute the Program or its derivative works. These actions are prohibited by law if you do not accept this License. Therefore, by modifying or distributing the Program (or any work based on the Program), you indicate your acceptance of this License to do so, and all its terms and conditions for copying, distributing or modifying the Program or works based on it.

6. Each time you redistribute the Program (or any work based on the Program), the recipient automatically receives a license from the original licensor to copy, distribute or modify the Program subject to these terms and conditions. You may not impose any further restrictions on the recipients' exercise of the rights granted herein. You are not responsible for enforcing compliance by third parties to this License.

7. If, as a consequence of a court judgment or allegation of patent infringement or for any other reason (not limited to patent issues), conditions are imposed on you (whether by court order, agreement or otherwise) that contradict the conditions of this License, they do not excuse you from the conditions of this License. If you cannot distribute so as to satisfy simultaneously your obligations under this License and any other pertinent obligations, then as a consequence you may not distribute the Program at all. For example, if a patent license would not permit royalty-free redistribution of the Program by all those who receive copies directly or indirectly through you, then the only way you could satisfy both it and this License would be to refrain entirely from distribution of the Program.

If any portion of this section is held invalid or unenforceable under any particular circumstance, the balance of the section is intended to apply and the section as a whole is intended to apply in other circumstances.

It is not the purpose of this section to induce you to infringe any patents or other property right claims or to contest validity of any such claims; this section has the sole purpose of protecting the integrity of the free software distribution system, which is implemented by public license practices. Many people have made generous contributions to the wide range of software distributed through that system in reliance on consistent application of that system; it is up to the author/donor to decide if he or she is willing to distribute software through any other system and a licensee cannot impose that choice.

This section is intended to make thoroughly clear what is believed to be a consequence of the rest of this License.

8. If the distribution and/or use of the Program is restricted in certain countries either by patents or by copyrighted interfaces, the original copyright holder who places the Program under this License may add an explicit geographical distribution limitation excluding those countries, so that distribution is permitted only in or among countries not thus excluded. In such case, this License incorporates the limitation as if written in the body of this License.

9. The Free Software Foundation may publish revised and/or new versions of the General Public License from time to time. Such new versions will be similar in spirit to the present version, but may differ in detail to address new problems or concerns.

Each version is given a distinguishing version number. If the Program specifies a version number of this License which applies to it and "any later version", you have the option of following the terms and conditions either of that version or of any later version published by the Free Software Foundation. If the Program does not specify a version number of this License, you may choose any version ever published by the Free Software Foundation.

10. If you wish to incorporate parts of the Program into other free programs whose distribution conditions are different, write to the author to ask for permission. For software which is copyrighted by the Free Software Foundation, write to the Free Software Foundation; we sometimes make exceptions for this. Our decision will be guided by the two goals of preserving the free status of all derivatives of our free software and of promoting the sharing and reuse of software generally.

### NO WARRANTY

11. BECAUSE THE PROGRAM IS LICENSED FREE OF CHARGE, THERE IS NO WARRANTY FOR THE PROGRAM, TO THE EXTENT PERMITTED BY APPLICABLE LAW. EXCEPT WHEN OTHERWISE STATED IN WRITING THE COPYRIGHT HOLDERS AND/OR OTHER PARTIES PROVIDE THE PROGRAM "AS IS" WITHOUT WARRANTY OF ANY KIND, EITHER EXPRESSED OR IMPLIED, INCLUDING, BUT NOT LIMITED TO, THE IMPLIED WARRANTIES OF MERCHANTABILITY AND FITNESS FOR A PARTICULAR



PURPOSE. THE ENTIRE RISK AS TO THE QUALITY AND PERFORMANCE OF THE PROGRAM IS WITH YOU. SHOULD THE PROGRAM PROVE DEFECTIVE, YOU ASSUME THE COST OF ALL NECESSARY SERVICING, REPAIR OR CORRECTION.

12. IN NO EVENT UNLESS REQUIRED BY APPLICABLE LAW OR AGREED TO IN WRITING WILL ANY COPYRIGHT HOLDER, OR ANY OTHER PARTY WHO MAY MODIFY AND/OR REDISTRIBUTE THE PROGRAM AS PERMITTED ABOVE, BE LIABLE TO YOU FOR DAMAGES, INCLUDING ANY GENERAL, SPECIAL, INCIDENTAL OR CONSEQUENTIAL DAMAGES ARISING OUT OF THE USE OR INABILITY TO USE THE PROGRAM (INCLUDING BUT NOT LIMITED TO LOSS OF DATA OR DATA BEING RENDERED INACCURATE OR LOSSES SUSTAINED BY YOU OR THIRD PARTIES OR A FAILURE OF THE PROGRAM TO OPERATE WITH ANY OTHER PROGRAMS), EVEN IF SUCH HOLDER OR OTHER PARTY HAS BEEN ADVISED OF THE POSSIBILITY OF SUCH DAMAGES.

#### END OF TERMS AND CONDITIONS

How to Apply These Terms to Your New Programs

If you develop a new program, and you want it to be of the greatest possible use to the public, the best way to achieve this is to make it free software which everyone can redistribute and change under these terms.

To do so, attach the following notices to the program. It is safest to attach them to the start of each source file to most effectively convey the exclusion of warranty; and each file should have at least the "copyright" line and a pointer to where the full notice is found.

one line to give the program's name and an idea of what it does.

Copyright (C) yyyy name of author

This program is free software; you can redistribute it and/or modify it under the terms of the GNU General Public License as published by the Free Software Foundation; either version 2 of the License, or (at your option) any later version.

This program is distributed in the hope that it will be useful, but WITHOUT ANY WARRANTY; without even the implied warranty of MERCHANTABILITY or FITNESS FOR A PARTICULAR PURPOSE. See the GNU General Public License for more details.

You should have received a copy of the GNU General Public License along with this program; if not, write to the Free Software Foundation, Inc., 51 Franklin Street, Fifth Floor, Boston, MA 02110-1301, USA. Also add information on how to contact you by electronic and paper mail.

If the program is interactive, make it output a short notice like this when it starts in an interactive mode:

Gnomovision version 69, Copyright (C) year name of author Gnomovision comes with ABSOLUTELY NO WARRANTY; for details type `show w'. This is free software, and you are welcome to redistribute it under certain conditions; type `show c' for details.

The hypothetical commands `show w' and `show c' should show the appropriate parts of the General Public License. Of course, the commands you use may be called something other than `show w' and `show c'; they could even be mouse-clicks or menu items--whatever suits your program.

You should also get your employer (if you work as a programmer) or your school, if any, to sign a "copyright disclaimer" for the program, if necessary. Here is a sample; alter the names:

Yooyodyne, Inc., hereby disclaims all copyright interest in the program `Gnomovision' (which makes passes at compilers) written by James Hacker.

signature of Ty Coon, 1 April 1989

Ty Coon, President of Vice

This General Public License does not permit incorporating your program into proprietary programs. If your program is a subroutine library, you may consider it more useful to permit linking proprietary applications with the library. If this is what you want to do, use the GNU Lesser General Public License instead of this License.

If you are interested in obtaining GPL source code used in this product, please contact P&F USA, Inc., PO Box 430 Daleville, IN 47334-0430 U.S.A.

#### LGPL

#### GNU LESSER GENERAL PUBLIC LICENSE

Version 2.1, February 1999

Copyright (C) 1991, 1999 Free Software Foundation, Inc.  
51 Franklin Street, Fifth Floor, Boston, MA 02110-1301 USA

Everyone is permitted to copy and distribute verbatim copies of this license document, but changing it is not allowed.

[This is the first released version of the Lesser GPL. It also counts as the successor of the GNU Library Public License, version 2, hence the version number 2.1.]

#### Preamble

The licenses for most software are designed to take away your freedom to share and change it. By contrast, the GNU General Public Licenses are intended to guarantee your freedom to share and change free software--to make sure the software is free for all its users.

This license, the Lesser General Public License, applies to some specially designated software packages--typically libraries--of the Free Software Foundation and other authors who decide to use it. You can use it too, but we suggest you first think carefully about whether this license or the ordinary General Public License is the better strategy to use in any particular case, based on the explanations below.

When we speak of free software, we are referring to freedom of use, not price. Our General Public Licenses are designed to make sure that you have the freedom to distribute copies of free software (and charge for this service if you wish); that you receive source code or can get it if you want it; that you can change the software and use pieces of it in new free programs; and that you are informed that you can do these things.

To protect your rights, we need to make restrictions that forbid distributors to deny you these rights or to ask you to surrender these rights. These restrictions translate to certain responsibilities for you if you distribute copies of the library or if you modify it.

For example, if you distribute copies of the library, whether gratis or for a fee, you must give the recipients all the rights that we gave you. You must make sure that they, too, receive or can get the source code. If you link other code with the library, you must provide complete object files to the recipients, so that they can relink them with the library after making changes to the library and recompiling it. And you must show them these terms so they know their rights.

We protect your rights with a two-step method: (1) we copyright the library; and (2) we offer you this license, which gives you legal permission to copy, distribute and/or modify the library.

To protect each distributor, we want to make it very clear that there is no warranty for the free library. Also, if the library is modified by someone else and passed on, the recipients should know

that what they have is not the original version, so that the original author's reputation will not be affected by problems that might be introduced by others.

Finally, software patents pose a constant threat to the existence of any free program. We wish to make sure that a company cannot effectively restrict the users of a free program by obtaining a restrictive license from a patent holder. Therefore, we insist that any patent license obtained for a version of the library must be consistent with the full freedom of use specified in this license.

Most GNU software, including some libraries, is covered by the ordinary GNU General Public License. This license, the GNU Lesser General Public License, applies to certain designated libraries, and is quite different from the ordinary General Public License. We use this license for certain libraries in order to permit linking those libraries into non-free programs.

When a program is linked with a library, whether statically or using a shared library, the combination of the two is legally speaking a combined work, a derivative of the original library. The ordinary General Public License therefore permits such linking only if the entire combination fits its criteria of freedom. The Lesser General Public License permits more lax criteria for linking other code with the library.

We call this license the "Lesser" General Public License because it does Less to protect the user's freedom than the ordinary General Public License. It also provides other free software developers Less of an advantage over competing non-free programs. These disadvantages are the reason we use the ordinary General Public License for many libraries. However, the Lesser license provides advantages in certain special circumstances.

For example, on rare occasions, there may be a special need to encourage the widest possible use of a certain library, so that it becomes a de-facto standard. To achieve this, non-free programs must be allowed to use the library. A more frequent case is that a free library does the same job as widely used non-free libraries. In this case, there is little to gain by limiting the free library to free software only, so we use the Lesser General Public License.

In other cases, permission to use a particular library in non-free programs enables a greater number of people to use a large body of free software. For example, permission to use the GNU C Library in non-free programs enables many more people to use the whole GNU operating system, as well as its variant, the GNU/Linux operating system.

Although the Lesser General Public License is Less protective of the users' freedom, it does ensure that the user of a program that is linked with the Library has the freedom and the wherewithal to run that program using a modified version of the Library.

The precise terms and conditions for copying, distribution and modification follow. Pay close attention to the difference between a "work based on the library" and a "work that uses the library". The former contains code derived from the library, whereas the latter must be combined with the library in order to run.

#### GNU LESSER GENERAL PUBLIC LICENSE

#### TERMS AND CONDITIONS FOR COPYING, DISTRIBUTION AND MODIFICATION

0. This License Agreement applies to any software library or other program which contains a notice placed by the copyright holder or other authorized party saying it may be distributed under the terms of this Lesser General Public License (also called "this License"). Each licensee is addressed as "you".

A "library" means a collection of software functions and/or data prepared so as to be conveniently linked with application programs (which use some of those functions and data) to form executables.

The "Library", below, refers to any such software library or work which has been distributed under these terms. A "work based on the Library" means either the Library or any derivative work under copyright law; that is to say, a work containing the Library or a portion of it, either verbatim or with modifications and/or translated straightforwardly into another language. (Hereinafter, translation is included without limitation in the term "modification".)

"Source code" for a work means the preferred form of the work for making modifications to it. For a library, complete source code means all the source code for all modules it contains, plus any associated interface definition files, plus the scripts used to control compilation and installation of the library.

Activities other than copying, distribution and modification are not covered by this License; they are outside its scope. The act of running a program using the Library is not restricted, and output from such a program is covered only if its contents constitute a work based on the Library (independent of the use of the Library in a tool for writing it). Whether that is true depends on what the Library does and what the program that uses the Library does.

1. You may copy and distribute verbatim copies of the Library's complete source code as you receive it, in any medium, provided that you conspicuously and appropriately publish on each copy an appropriate copyright notice and disclaimer of warranty; keep intact all the notices that refer to this License and to the absence of any warranty; and distribute a copy of this License along with the Library.

You may charge a fee for the physical act of transferring a copy, and you may at your option offer warranty protection in exchange for a fee.

2. You may modify your copy or copies of the Library or any portion of it, thus forming a work based on the Library, and copy and distribute such modifications or work under the terms of Section 1 above, provided that you also meet all these conditions:

a) The modified work must itself be a software library.

b) You must cause the files modified to carry prominent notices stating that you changed the files and the date of any change.

c) You must cause the whole of the work to be licensed at no charge to all third parties under the terms of this License.

d) If a facility in the modified Library refers to a function or a table of data to be supplied by an application program that uses the facility, other than as an argument passed when the facility is invoked, then you must make a good faith effort to ensure that, in the event an application does not supply such function or table, the facility still operates, and performs whatever part of its purpose remains meaningful.

(For example, a function in a library to compute square roots has a purpose that is entirely well-defined independent of the application. Therefore, Subsection 2d requires that any application-supplied function or table used by this function must be optional: if the application does not supply it, the square root function must still compute square roots.)

These requirements apply to the modified work as a whole. If identifiable sections of that work are not derived from the Library, and can be reasonably considered independent and separate works in themselves, then this License, and its terms, do not apply to those sections when you distribute them as separate works. But when you distribute the same sections as part of a whole which is a work based on the Library, the distribution of the whole must be on the terms of this License, whose permissions for other licensees extend to the entire whole, and thus to each and every part regardless of who wrote it.

Thus, it is not the intent of this section to claim rights or contest your rights to work written entirely by you; rather, the intent is to exercise the right to control the distribution of derivative or collective works based on the Library.

In addition, mere aggregation of another work not based on the Library with the Library (or with a work based on the Library) on a volume of a storage or distribution medium does not bring the other work under the scope of this License.

3. You may opt to apply the terms of the ordinary GNU General Public License instead of this License to a given copy of the Library. To do this, you must alter all the notices that refer to this License, so that they refer to the ordinary GNU General Public License, version 2, instead of to this License. (If a newer version than version 2 of the ordinary GNU General Public License has appeared, then you can specify that version instead if you wish.) Do not make any other change in these notices.

Once this change is made in a given copy, it is irreversible for that copy, so the ordinary GNU General Public License applies to all subsequent copies and derivative works made from that copy.

This option is useful when you wish to copy part of the code of the Library into a program that is not a library.

4. You may copy and distribute the Library (or a portion or derivative of it, under Section 2) in object code or executable form under the terms of Sections 1 and 2 above provided that you accompany it with the complete corresponding machine-readable source code, which must be distributed under the terms of Sections 1 and 2 above on a medium customarily used for software interchange.

If distribution of object code is made by offering access to copy from a designated place, then offering equivalent access to copy the source code from the same place satisfies the requirement to distribute the source code, even though third parties are not compelled to copy the source along with the object code.

5. A program that contains no derivative of any portion of the Library, but is designed to work with the Library by being compiled or linked with it, is called a "work that uses the Library". Such a work, in isolation, is not a derivative work of the Library, and therefore falls outside the scope of this License.

However, linking a "work that uses the Library" with the Library creates an executable that is a derivative of the Library (because it contains portions of the Library), rather than a "work that uses the library". The executable is therefore covered by this License. Section 6 states terms for distribution of such executables.

When a "work that uses the Library" uses material from a header file that is part of the Library, the object code for the work may be a derivative work of the Library even though the source code is not. Whether this is true is especially significant if the work can be linked without the Library, or if the work is itself a library. The threshold for this to be true is not precisely defined by law.

If such an object file uses only numerical parameters, data structure layouts and accessors, and small macros and small inline functions (ten lines or less in length), then the use of the object file is unrestricted, regardless of whether it is legally a derivative work. (Executables containing this object code plus portions of the Library will still fall under Section 6.)

Otherwise, if the work is a derivative of the Library, you may distribute the object code for the work under the terms of Section 6. Any executables containing that work also fall under Section 6, whether or not they are linked directly with the Library itself.

6. As an exception to the Sections above, you may also combine or link a "work that uses the Library" with the Library to produce a work containing portions of the Library, and distribute that work under terms of your choice, provided that the terms permit modification of the work for the customer's own use and reverse engineering for debugging such modifications.

You must give prominent notice with each copy of the work that the Library is used in it and that the Library and its use are covered by this License. You must supply a copy of this License. If the work during execution displays copyright notices, you must include the copyright notice for the Library among them, as well as a reference directing the user to the copy of this License. Also, you must do one of these things:

- a) Accompany the work with the complete corresponding machine-readable source code for the Library including whatever changes were used in the work (which must be distributed under Sections 1 and 2 above), and, if the work is an executable linked with the Library, with the complete machine-readable "work that uses the Library", as object code and/or source code, so that the user can modify the Library and then relink to produce a modified executable containing the modified Library. (It is understood that the user who changes the contents of definitions files in the Library will not necessarily be able to recompile the application to use the modified definitions.)

- b) Use a suitable shared library mechanism for linking with the Library. A suitable mechanism is one that (1) uses at run time a copy of the library already present on the user's computer system, rather than copying library functions into the executable, and (2) will operate properly with a modified version of the library, if the user installs one, as long as the modified version is interface-compatible with the version that the work was made with.

- c) Accompany the work with a written offer, valid for at least three years, to give the same user the materials specified in Subsection 6a, above, for a charge no more than the cost of performing this distribution.

- d) If distribution of the work is made by offering access to copy from a designated place, offer equivalent access to copy the above specified materials from the same place.

- e) Verify that the user has already received a copy of these materials or that you have already sent this user a copy.

For an executable, the required form of the "work that uses the Library" must include any data and utility programs needed for reproducing the executable from it. However, as a special exception, the materials to be distributed need not include anything that is normally distributed (in either source or binary form) with the major components (compiler, kernel, and so on) of the operating system on which the executable runs, unless that component itself accompanies the executable.

It may happen that this requirement contradicts the license restrictions of other proprietary libraries that do not normally accompany the operating system. Such a contradiction means you cannot use both them and the Library together in an executable that you distribute.

7. You may place library facilities that are a work based on the Library side-by-side in a single library together with other library facilities not covered by this License, and distribute such a combined library, provided that the separate distribution of the work based on the Library and of the other library facilities is otherwise permitted, and provided that you do these two things:

- a) Accompany the combined library with a copy of the same work based on the Library, uncombined with any other library facilities. This must be distributed under the terms of the Sections above.

- b) Give prominent notice with the combined library of the fact that part of it is a work based on the Library, and explaining where to find the accompanying uncombined form of the same work.

8. You may not copy, modify, sublicense, link with, or distribute the Library except as expressly provided under this License. Any attempt otherwise to copy, modify, sublicense, link with, or

distribute the Library is void, and will automatically terminate your rights under this License. However, parties who have received copies, or rights, from you under this License will not have their licenses terminated so long as such parties remain in full compliance.

9. You are not required to accept this License, since you have not signed it. However, nothing else grants you permission to modify or distribute the Library or its derivative works. These actions are prohibited by law if you do not accept this License. Therefore, by modifying or distributing the Library (or any work based on the Library), you indicate your acceptance of this License to do so, and all its terms and conditions for copying, distributing or modifying the Library or works based on it.

10. Each time you redistribute the Library (or any work based on the Library), the recipient automatically receives a license from the original licensor to copy, distribute, link with or modify the Library subject to these terms and conditions. You may not impose any further restrictions on the recipients' exercise of the rights granted herein. You are not responsible for enforcing compliance by third parties with this License.

11. If, as a consequence of a court judgment or allegation of patent infringement or for any other reason (not limited to patent issues), conditions are imposed on you (whether by court order, agreement or otherwise) that contradict the conditions of this License, they do not excuse you from the conditions of this License. If you cannot distribute so as to satisfy simultaneously your obligations under this License and any other pertinent obligations, then as a consequence you may not distribute the Library at all. For example, if a patent license would not permit royalty-free redistribution of the Library by all those who receive copies directly or indirectly through you, then the only way you could satisfy both it and this License would be to refrain entirely from distribution of the Library.

If any portion of this section is held invalid or unenforceable under any particular circumstance, the balance of the section is intended to apply, and the section as a whole is intended to apply in other circumstances.

It is not the purpose of this section to induce you to infringe any patents or other property right claims or to contest validity of any such claims; this section has the sole purpose of protecting the integrity of the free software distribution system which is implemented by public license practices. Many people have made generous contributions to the wide range of software distributed through that system in reliance on consistent application of that system; it is up to the author/donor to decide if he or she is willing to distribute software through any other system and a licensee cannot impose that choice.

This section is intended to make thoroughly clear what is believed to be a consequence of the rest of this License.

12. If the distribution and/or use of the Library is restricted in certain countries either by patents or by copyrighted interfaces, the original copyright holder who places the Library under this License may add an explicit geographical distribution limitation excluding those countries, so that distribution is permitted only in or among countries not thus excluded. In such case, this License incorporates the limitation as if written in the body of this License.

13. The Free Software Foundation may publish revised and/or new versions of the Lesser General Public License from time to time. Such new versions will be similar in spirit to the present version, but may differ in detail to address new problems or concerns.

Each version is given a distinguishing version number. If the Library specifies a version number of this License which applies to it and "any later version", you have the option of following the terms and conditions either of that version or of any later version published by the Free Software Foundation. If the Library does not specify a license version number, you may choose any version ever published by the Free Software Foundation.

14. If you wish to incorporate parts of the Library into other free programs whose distribution conditions are incompatible with these, write to the author to ask for permission. For software which is copyrighted by the Free Software Foundation, write to the Free Software Foundation; we sometimes make exceptions for this. Our decision will be guided by the two goals of preserving the free status of all derivatives of our free software and of promoting the sharing and reuse of software generally.

#### NO WARRANTY

15. BECAUSE THE LIBRARY IS LICENSED FREE OF CHARGE, THERE IS NO WARRANTY FOR THE LIBRARY, TO THE EXTENT PERMITTED BY APPLICABLE LAW, EXCEPT WHEN OTHERWISE STATED IN WRITING THE COPYRIGHT HOLDERS AND/OR OTHER PARTIES PROVIDE THE LIBRARY "AS IS" WITHOUT WARRANTY OF ANY KIND, EITHER EXPRESSED OR IMPLIED, INCLUDING, BUT NOT LIMITED TO, THE IMPLIED WARRANTIES OF MERCHANTABILITY AND FITNESS FOR A PARTICULAR PURPOSE. THE ENTIRE RISK AS TO THE QUALITY AND PERFORMANCE OF THE LIBRARY IS WITH YOU. SHOULD THE LIBRARY PROVE DEFECTIVE, YOU ASSUME THE COST OF ALL NECESSARY SERVICING, REPAIR OR CORRECTION.

16. IN NO EVENT UNLESS REQUIRED BY APPLICABLE LAW OR AGREED TO IN WRITING WILL ANY COPYRIGHT HOLDER, OR ANY OTHER PARTY WHO MAY MODIFY AND/OR REDISTRIBUTE THE LIBRARY AS PERMITTED ABOVE, BE LIABLE TO YOU FOR DAMAGES, INCLUDING ANY GENERAL, SPECIAL, INCIDENTAL OR CONSEQUENTIAL DAMAGES ARISING OUT OF THE USE OR INABILITY TO USE THE LIBRARY (INCLUDING BUT NOT LIMITED TO LOSS OF DATA OR DATA BEING RENDERED INACCURATE OR LOSSES SUSTAINED BY YOU OR THIRD PARTIES OR A FAILURE OF THE LIBRARY TO OPERATE WITH ANY OTHER SOFTWARE), EVEN IF SUCH HOLDER OR OTHER PARTY HAS BEEN ADVISED OF THE POSSIBILITY OF SUCH DAMAGES.

#### END OF TERMS AND CONDITIONS

##### How to Apply These Terms to Your New Libraries

If you develop a new library, and you want it to be of the greatest possible use to the public, we recommend making it free software that everyone can redistribute and change. You can do so by permitting redistribution under these terms (or, alternatively, under the terms of the ordinary General Public License).

To apply these terms, attach the following notices to the library. It is safest to attach them to the start of each source file to most effectively convey the exclusion of warranty; and each file should have at least the "copyright" line and a pointer to where the full notice is found.

<one line to give the library's name and a brief idea of what it does.>Copyright (C) <year>  
<name of author>

This library is free software; you can redistribute it and/or modify it under the terms of the GNU Lesser General Public License as published by the Free Software Foundation; either version 2.1 of the License, or (at your option) any later version.

This library is distributed in the hope that it will be useful, but WITHOUT ANY WARRANTY; without even the implied warranty of MERCHANTABILITY or FITNESS FOR A PARTICULAR PURPOSE. See the GNU Lesser General Public License for more details.

You should have received a copy of the GNU Lesser General Public License along with this library; if not, write to the Free Software Foundation, Inc., 51 Franklin Street, Fifth Floor, Boston, MA 02110-1301 USA

Also add information on how to contact you by electronic and paper mail.

You should also get your employer (if you work as a programmer) or your school, if any, to sign a "copyright disclaimer" for the library, if necessary. Here is a sample; alter the names:

```
Yoyodyne, Inc., hereby disclaims all copyright interest in the library 'Frob' (a library for tweaking knobs) written by James Random Hacker.
<signature of Ty Coon>, 1 April 1990
Ty Coon, President of Vice
That's all there is to it!
```

If you are interested in obtaining LGPL source code used in this product, please contact P&F USA, Inc., PO Box 430 Daleville, IN 47334-0430 U.S.A.

---

## BSD

"Copyright (c) 2003-2010, Jouni Malinen <j@w1.fi> and contributors All Rights Reserved.

Redistribution and use in source and binary forms, with or without modification, are permitted provided that the following conditions are met:

1. Redistributions of source code must retain the above copyright notice, this list of conditions and the following disclaimer.
2. Redistributions in binary form must reproduce the above copyright notice, this list of conditions and the following disclaimer in the documentation and/or other materials provided with the distribution.
3. Neither the name(s) of the above-listed copyright holder(s) nor the names of its contributors may be used to endorse or promote products derived from this software without specific prior written permission.

THIS SOFTWARE IS PROVIDED BY THE COPYRIGHT HOLDERS AND CONTRIBUTORS "AS IS" AND ANY EXPRESS OR IMPLIED WARRANTIES, INCLUDING, BUT NOT LIMITED TO, THE IMPLIED WARRANTIES OF MERCHANTABILITY AND FITNESS FOR A PARTICULAR PURPOSE ARE DISCLAIMED. IN NO EVENT SHALL THE COPYRIGHT OWNER OR CONTRIBUTORS BE LIABLE FOR ANY DIRECT, INDIRECT, INCIDENTAL, SPECIAL, EXEMPLARY, OR CONSEQUENTIAL DAMAGES (INCLUDING, BUT NOT LIMITED TO, PROCUREMENT OF SUBSTITUTE GOODS OR SERVICES; LOSS OF USE, DATA, OR PROFITS; OR BUSINESS INTERRUPTION) HOWEVER CAUSED AND ON ANY THEORY OF LIABILITY, WHETHER IN CONTRACT, STRICT LIABILITY, OR TORT (INCLUDING NEGLIGENCE OR OTHERWISE) ARISING IN ANY WAY OUT OF THE USE OF THIS SOFTWARE, EVEN IF ADVISED OF THE POSSIBILITY OF SUCH DAMAGE."

---

## MIT

• expat  
Copyright © 1998, 1999, 2000 Thai Open Source Software Center Ltd and Clark Cooper  
Copyright © 2001, 2002, 2003, 2004, 2005, 2006 Expat maintainers.

• lua  
Copyright © 1994 -2010 Lua.org, PUC-Rio.

• lua-xmlreader  
Copyright © 2008 A.S. Bradbury

• lua-sncrypto  
Copyright © 2005 Malet Partner, Berlin, partner@malet.org

• libxml2  
Copyright © 1998-2003 Daniel Veillard. All Rights Reserved.

• c-ares  
Copyright 1998 by the Massachusetts Institute of Technology.

Permission is hereby granted, free of charge, to any person obtaining a copy of this software and associated documentation files (the "Software"), to deal in the Software without restriction, including without limitation the rights to use, copy, modify, merge, publish, distribute, sublicense, and/or sell copies of the Software, and to permit persons to whom the Software is furnished to do so, subject to the following conditions:

The above copyright notice and this permission notice shall be included in all copies or substantial portions of the Software.

THE SOFTWARE IS PROVIDED "AS IS", WITHOUT WARRANTY OF ANY KIND, EXPRESS OR IMPLIED, INCLUDING BUT NOT LIMITED TO THE WARRANTIES OF MERCHANTABILITY, FITNESS FOR A PARTICULAR PURPOSE AND NONINFRINGEMENT. IN NO EVENT SHALL THE AUTHORS OR COPYRIGHT HOLDERS BE LIABLE FOR ANY CLAIM, DAMAGES OR OTHER LIABILITY, WHETHER IN AN ACTION OF CONTRACT, TORT OR OTHERWISE, ARISING FROM, OUT OF OR IN CONNECTION WITH THE SOFTWARE OR THE USE OR OTHER DEALINGS IN THE SOFTWARE.

---

## Free Type

Portions of this software are copyright (c) 2006, 2007, 2008, 2009 The FreeType Project (www.freetype.org). All rights reserved.

---

## LibJPEG

This software is based in part on the work of the Independent JPEG Group.

---

## Open SSL

### LICENSE ISSUES

=====

The OpenSSL toolkit stays under a dual license, i.e. both the conditions of the OpenSSL License and the original SSLeay license apply to the toolkit. See below for the actual license texts. Actually both licenses are BSD-style Open Source licenses. In case of any license issues related to OpenSSL please contact openssl-core@openssl.org.

OpenSSL License

/\* =====

Copyright (c) 1998-2008 The OpenSSL Project. All rights reserved.

## IV

Redistribution and use in source and binary forms, with or without modification, are permitted provided that the following conditions are met:

1. Redistributions of source code must retain the above copyright notice, this list of conditions and the following disclaimer.
2. Redistributions in binary form must reproduce the above copyright notice, this list of conditions and the following disclaimer in the documentation and/or other materials provided with the distribution.
3. All advertising materials mentioning features or use of this software must display the following acknowledgment: "This product includes software developed by the OpenSSL Project for use in the OpenSSL Toolkit. (http://www.openssl.org/)"
4. The names "OpenSSL Toolkit" and "OpenSSL Project" must not be used to endorse or promote products derived from this software without prior written permission. For written permission, please contact openssl-core@openssl.org.
5. Products derived from this software may not be called "OpenSSL" nor may "OpenSSL" appear in their names without prior written permission of the OpenSSL Project.
6. Redistributions of any form whatsoever must retain the following acknowledgment: "This product includes software developed by the OpenSSL Project for use in the OpenSSL Toolkit (http://www.openssl.org/)"

THIS SOFTWARE IS PROVIDED BY THE OpenSSL PROJECT "AS IS" AND ANY EXPRESS OR IMPLIED WARRANTIES, INCLUDING, BUT NOT LIMITED TO, THE IMPLIED WARRANTIES OF MERCHANTABILITY AND FITNESS FOR A PARTICULAR PURPOSE ARE DISCLAIMED. IN NO EVENT SHALL THE OpenSSL PROJECT OR ITS CONTRIBUTORS BE LIABLE FOR ANY DIRECT, INDIRECT, INCIDENTAL, SPECIAL, EXEMPLARY, OR CONSEQUENTIAL DAMAGES (INCLUDING, BUT NOT LIMITED TO, PROCUREMENT OF SUBSTITUTE GOODS OR SERVICES; LOSS OF USE, DATA, OR PROFITS; OR BUSINESS INTERRUPTION) HOWEVER CAUSED AND ON ANY THEORY OF LIABILITY, WHETHER IN CONTRACT, STRICT LIABILITY, OR TORT (INCLUDING NEGLIGENCE OR OTHERWISE) ARISING IN ANY WAY OUT OF THE USE OF THIS SOFTWARE, EVEN IF ADVISED OF THE POSSIBILITY OF SUCH DAMAGE.

=====

This product includes cryptographic software written by Eric Young (eay@cryptsoft.com). This product includes software written by Tim Hudson (tjh@cryptsoft.com).

---

## Original SSLeay License

/\* Copyright (C) 1995-1998 Eric Young (eay@cryptsoft.com) All rights reserved.  
\* This package is an SSL implementation written by Eric Young (eay@cryptsoft.com).  
\* The implementation was written so as to conform with Netscapes SSL.  
\* This library is free for commercial and non-commercial use as long as the following conditions  
\* are aared to. The following conditions apply to all code found in this distribution, be it the  
\* RC4, RSA, lhash, DES, etc., code; not just the SSL code. The SSL documentation included with  
\* this distribution is covered by the same copyright terms except that the holder is Tim Hudson  
\* (tjh@cryptsoft.com).  
\* Copyright remains Eric Young's, and as such any Copyright notices in the code are not to be  
\* removed.  
\* If this package is used in a product, Eric Young should be given attribution as the author of the  
\* parts of the library used.  
\* This can be in the form of a textual message at program startup or in documentation (online  
\* or textual) provided with the package.  
\* Redistribution and use in source and binary forms, with or without modification, are permitted  
\* provided that the following conditions are met:  
\* 1. Redistributions of source code must retain the copyright notice, this list of conditions and  
\* the following disclaimer:  
\* 2. Redistributions in binary form must reproduce the above copyright notice, this list of condi-  
\* tions and the following disclaimer in the documentation and/or other materials provided  
\* with the distribution.  
\* 3. All advertising materials mentioning features or use of this software must display the fol-  
\* lowing acknowledgement: "This product includes cryptographic software written by Eric  
\* Young (eay@cryptsoft.com)" The word 'cryptographic' can be left out if the rouines from  
\* the library being used are not cryptographic related :-).  
\* 4. If you include any Windows specific code (or a derivative thereof) from the apps directory  
\* (application code) you must include an acknowledgement: "This product includes software  
\* written by Tim Hudson (tjh@cryptsoft.com)"

\*/ THIS SOFTWARE IS PROVIDED BY ERIC YOUNG "AS IS" AND ANY EXPRESS OR IMPLIED WARRANTIES, INCLUDING, BUT NOT LIMITED TO, THE IMPLIED WARRANTIES OF MERCHANTABILITY AND FITNESS FOR A PARTICULAR PURPOSE ARE DISCLAIMED. IN NO EVENT SHALL THE AUTHOR OR CONTRIBUTORS BE LIABLE FOR ANY DIRECT, INDIRECT, INCIDENTAL, SPECIAL, EXEMPLARY, OR CONSEQUENTIAL DAMAGES (INCLUDING, BUT NOT LIMITED TO, PROCUREMENT OF SUBSTITUTE GOODS OR SERVICES; LOSS OF USE, DATA, OR PROFITS; OR BUSINESS INTERRUPTION) HOWEVER CAUSED AND ON ANY THEORY OF LIABILITY, WHETHER IN CONTRACT, STRICT LIABILITY, OR TORT (INCLUDING NEGLIGENCE OR OTHERWISE) ARISING IN ANY WAY OUT OF THE USE OF THIS SOFTWARE, EVEN IF ADVISED OF THE POSSIBILITY OF SUCH DAMAGE.

The licence and distribution terms for any publically available version or derivative of this code cannot be changed. i.e. this code cannot simply be copied and put under another distribution licence [including the GNU Public Licence.]

---

## JSON\_Parser

Copyright (c) 2005 JSON.org

Permission is hereby granted, free of charge, to any person obtaining a copy of this software and associated documentation files (the "Software"), to deal in the Software without restriction, including without limitation the rights to use, copy, modify, merge, publish, distribute, sublicense, and/or sell copies of the Software, and to permit persons to whom the Software is furnished to do so, subject to the following conditions:

The above copyright notice and this permission notice shall be included in all copies or substantial portions of the Software.

The Software shall be used for Good, not Evil.

THE SOFTWARE IS PROVIDED "AS IS", WITHOUT WARRANTY OF ANY KIND, EXPRESS OR IMPLIED, INCLUDING BUT NOT LIMITED TO THE WARRANTIES OF MERCHANTABILITY, FITNESS FOR A PARTICULAR PURPOSE AND NONINFRINGEMENT. IN NO EVENT SHALL THE AUTHORS OR COPYRIGHT HOLDERS BE LIABLE FOR ANY CLAIM, DAMAGES OR OTHER LIABILITY, WHETHER IN AN ACTION OF CONTRACT, TORT OR OTHERWISE, ARISING FROM, OUT OF OR IN CONNECTION WITH THE SOFTWARE OR THE USE OR OTHER DEALINGS IN THE SOFTWARE.

## gSOAP

### gSOAP Public License

Part of the software embedded in this product is gSOAP software.

Portions created by gSOAP are Copyright (C) 2001-2009 Robert A. van Engelen, Genivia inc. All Rights Reserved.

THE SOFTWARE IN THIS PRODUCT WAS IN PART PROVIDED BY GENIVIA INC AND ANY EXPRESS OR IMPLIED WARRANTIES, INCLUDING, BUT NOT LIMITED TO, THE IMPLIED WARRANTIES OF MERCHANTABILITY AND FITNESS FOR A PARTICULAR PURPOSE ARE DISCLAIMED. IN NO EVENT SHALL THE AUTHOR BE LIABLE FOR ANY DIRECT, INDIRECT, INCIDENTAL, SPECIAL, EXEMPLARY, OR CONSEQUENTIAL DAMAGES (INCLUDING, BUT NOT LIMITED TO, PROCUREMENT OF SUBSTITUTE GOODS OR SERVICES; LOSS OF USE, DATA, OR PROFITS; OR BUSINESS INTERRUPTION) HOWEVER CAUSED AND ON ANY THEORY OF LIABILITY, WHETHER IN CONTRACT, STRICT LIABILITY, OR TORT (INCLUDING NEGLIGENCE OR OTHERWISE) ARISING IN ANY WAY OUT OF THE USE OF THIS SOFTWARE, EVEN IF ADVISED OF THE POSSIBILITY OF SUCH DAMAGE."

## libcurl

### COPYRIGHT AND PERMISSION NOTICE

Copyright (c) 1996 - 2009, Daniel Stenberg, <daniel@haxxx.se>. All rights reserved.

Permission to use, copy, modify, and distribute this software for any purpose with or without fee is hereby granted, provided that the above copyright notice and this permission notice appear in all copies.

THE SOFTWARE IS PROVIDED "AS IS", WITHOUT WARRANTY OF ANY KIND, EXPRESS OR IMPLIED, INCLUDING BUT NOT LIMITED TO THE WARRANTIES OF MERCHANTABILITY, FITNESS FOR A PARTICULAR PURPOSE AND NONINFRINGEMENT OF THIRD PARTY RIGHTS. IN NO EVENT SHALL THE AUTHORS OR COPYRIGHT HOLDERS BE LIABLE FOR ANY CLAIM, DAMAGES OR OTHER LIABILITY, WHETHER IN AN ACTION OF CONTRACT, TORT OR OTHERWISE, ARISING FROM, OUT OF OR IN CONNECTION WITH THE SOFTWARE OR THE USE OR OTHER DEALINGS IN THE SOFTWARE.

Except as contained in this notice, the name of a copyright holder shall not be used in advertising or otherwise to promote the sale, use or other dealings in this Software without prior written authorization of the copyright holder.

## Open GL

### Notice

License Applicability. Except to the extent portions of this file are made subject to an alternative license as permitted in the SGI Free Software License B, Version 1.0 (the "License"), the contents of this file are subject only to the provisions of the License. You may not use this file except in compliance with the License. You may obtain a copy of the License at Silicon Graphics, Inc., attn: Legal Services, 1600 Amphitheatre Parkway, Mountain View, CA 94043-1351, or at:

<http://oss.sgi.com/projects/FreeB>

Note that, as provided in the License, the Software is distributed on an "AS IS" basis, with ALL EXPRESS AND IMPLIED WARRANTIES AND CONDITIONS DISCLAIMED, INCLUDING, WITHOUT LIMITATION, ANY IMPLIED WARRANTIES AND CONDITIONS OF MERCHANTABILITY, SATISFACTORY QUALITY, FITNESS FOR A PARTICULAR PURPOSE, AND NON-INFRINGEMENT.

Original Code. The Original Code is: OpenGL Sample Implementation, Version 1.2.1, released January 26, 2000, developed by Silicon Graphics, Inc. The Original Code is Copyright (c) 1991-2000 Silicon Graphics, Inc. Copyright in any portions created by third parties is as indicated elsewhere herein. All Rights Reserved.

Additional Notice Provisions: The application programming interfaces established by SGI in conjunction with the Original Code are The OpenGL(R) Graphics System: A Specification (Version 1.2.1), released April 1, 1999; The OpenGL(R) Graphics System Utility Library (Version 1.3), released November 4, 1998; and OpenGL(R) Graphics with the XWindow System(R) (Version 1.3), released October 19, 1998. This software was created using the OpenGL(R) version 1.2.1 Sample Implementation published by SGI, but has not been independently verified as being compliant with the OpenGL(R) version 1.2.1 Specification.

### SGI FREE SOFTWARE LICENSE B (Version 1.1 [02/22/2000])

#### 1. Definitions.

- 1.1. "Additional Notice Provisions" means such additional provisions as appear in the Notice in Original Code under the heading "Additional Notice Provisions."
- 1.2. "Covered Code" means the Original Code or Modifications, or any combination thereof.
- 1.3. "Hardware" means any physical device that accepts input, processes input, stores the results of processing, and/or provides output.
- 1.4. "Larger Work" means a work that combines Covered Code or portions thereof with code not governed by the terms of this License.
- 1.5. "Licensable" means having the right to grant, to the maximum extent possible, whether at the time of the initial grant or subsequently acquired, any and all of the rights conveyed herein.
- 1.6. "License" means this document.
- 1.7. "Licensed Patents" means patent claims Licensable by SGI that are infringed by the use or sale of Original Code or any Modifications provided by SGI, or any combination thereof.
- 1.8. "Modifications" means any addition to or deletion from the substance or structure of the Original Code or any previous Modifications. When Covered Code is released as a series of files, a Modification is:
  - A. Any addition to the contents of a file containing Original Code and/or addition to or deletion from the contents of a file containing previous Modifications.
  - B. Any new file that contains any part of the Original Code or previous Modifications.
- 1.9. "Notice" means any notice in Original Code or Covered Code, as required by and in compliance with this License.
- 1.10. "Original Code" means source code of computer software code that is described in the source code Notice required by Exhibit A as Original Code, and updates and error corrections specifically thereto.
- 1.11. "Recipient" means an individual or a legal entity exercising rights under, and complying with all of the terms of, this License or a future version of this License issued under Section 8. For

legal entities, "Recipient" includes any entity that controls, is controlled by, or is under common control with Recipient. For purposes of this definition, "control" of an entity means (a) the power, direct or indirect, to direct or manage such entity, or (b) ownership of fifty percent (50%) or more of the outstanding shares or beneficial ownership of such entity.

- 1.12. "Recipient Patents" means patent claims Licensable by a Recipient that are infringed by the use or sale of Original Code or any Modifications provided by SGI, or any combination thereof.
- 1.13. "SGI" means Silicon Graphics, Inc.
- 1.14. "SGI Patents" means patent claims Licensable by SGI other than the Licensed Patents.
2. License Grant and Restrictions.
  - 2.1. SGI License Grant. Subject to the terms of this License and any third party intellectual property claims, for the duration of intellectual property protections inherent in the Original Code, SGI hereby grants Recipient a worldwide, royalty-free, non-exclusive license, to do the following: (i) under copyrights Licensable by SGI, to reproduce, distribute, create derivative works from, and, to the extent applicable, display and perform the Original Code and/or any Modifications provided by SGI alone and/or as part of a Larger Work; and (ii) under any Licensable Patents, to make, have made, use, sell, offer for sale, import and/or otherwise transfer the Original Code and/or any Modifications provided by SGI. Recipient accepts the terms and conditions of this License by undertaking any of the aforementioned actions. The patent license shall apply to the Covered Code if, at the time any related Modification is added, such addition of the Modification causes such combination to be covered by the Licensed Patents. The patent license in Section 2.1(ii) shall not apply to any other combinations that include the Modification. No patent license is provided under SGI Patents for infringements of SGI Patents by Modifications not provided by SGI or combinations of Original Code and Modifications not provided by SGI.
  - 2.2. Recipient License Grant. Subject to the terms of this License and any third party intellectual property claims, Recipient hereby grants SGI and any other Recipients a worldwide, royalty-free, non-exclusive license, under any Recipient Patents, to make, have made, use, sell, offer for sale, import and/or otherwise transfer the Original Code and/or any Modifications provided by SGI.
  - 2.3. No License For Hardware Implementations. The licenses granted in Section 2.1 and 2.2 are not applicable to implementation in Hardware of the algorithms embodied in the Original Code or any Modifications provided by SGI.
3. Redistributions.
  - 3.1. Retention of Notice/Copy of License. The Notice set forth in Exhibit A, below, must be conspicuously retained or included in any and all redistributions of Covered Code. For distributions of the Covered Code in source code form, the Notice must appear in every file that can include a text comments field; in executable form, the Notice and a copy of this License must appear in related documentation or collateral where the Recipient's rights relating to Covered Code are described. Any Additional Notice Provisions which actually appears in the Original Code must also be retained or included in any and all redistributions of Covered Code.
  - 3.2. Alternative License. Provided that Recipient is in compliance with the terms of this License, Recipient may, so long as without derogation of any of SGI's rights in and to the Original Code, distribute the source code and/or executable version(s) of Covered Code under (1) this License; (2) a license identical to this License but for only such changes as are necessary in order to clarify Recipient's role as licensor of Modifications; and/or (3) a license of Recipient's choosing, containing terms different from this License, provided that the license terms include this Section 3 and Sections 4, 6, 7, 10, 12, and 13, which terms may not be modified or superseded by any other terms of such license. If Recipient elects to use any license other than this License, Recipient must make it absolutely clear that any of its terms which differ from this License are offered by Recipient alone, and not by SGI. It is emphasized that this License is a limited license, and, regardless of the license form employed by Recipient in accordance with this Section 3.2, Recipient may relicense only such rights, in Original Code and Modifications by SGI, as it has actually been granted by SGI in this License.
  - 3.3. Indemnity. Recipient hereby agrees to indemnify SGI for any liability incurred by SGI as a result of any such alternative license terms Recipient offers.
4. Termination. This License and the rights granted hereunder will terminate automatically if Recipient breaches any term herein and fails to cure such breach within 30 days thereof. Any sublicense to the Covered Code that is properly granted shall survive any termination of this License, absent termination by the terms of such sublicense. Provisions that, by their nature, must remain in effect beyond the termination of this License, shall survive.
5. No Trademark Or Other Rights. This License does not grant any rights to: (i) any software apart from the Covered Code, nor shall any other rights or licenses not expressly granted hereunder arise by implication, estoppel or otherwise with respect to the Covered Code; (ii) any trade name, trademark or service mark whatsoever, including without limitation any related right for purposes of endorsement or promotion of products derived from the Covered Code, without prior written permission of SGI; or (iii) any title to or ownership of the Original Code, which shall at all times remain with SGI. All rights in the Original Code not expressly granted under this License are reserved.
6. Compliance with Laws; Non-Infringement. There are various worldwide laws, regulations, and executive orders applicable to dispositions of Covered Code, including without limitation export, re-export, and import control laws, regulations, and executive orders, of the U.S. government and other countries, and Recipient is reminded it is obliged to obey such laws, regulations, and executive orders. Recipient may not distribute Covered Code that (i) in any way infringes (directly or contributorily) any intellectual property rights of any kind of any other person or entity or (ii) breaches any representation or warranty, express, implied or statutory, to which, under any applicable law, it might be deemed to have been subject.
7. Claims of Infringement. If Recipient learns of any third party claim that any disposition of Covered Code and/or functionality wholly or partially infringes the third party's intellectual property rights, Recipient will promptly notify SGI of such claim.
8. Versions of the License. SGI may publish revised and/or new versions of the License from time to time, each with a distinguishing version number. Once Covered Code has been published under a particular version of the License, Recipient may, for the duration of the license, continue to use it under the terms of that version, or choose to use such Covered Code under the terms of any subsequent version published by SGI. Subject to the provisions of Sections 3 and 4 of this License, only SGI may modify the terms applicable to Covered Code created under this License.
9. DISCLAIMER OF WARRANTY. COVERED CODE IS PROVIDED "AS IS." ALL EXPRESS AND IMPLIED WARRANTIES AND CONDITIONS ARE DISCLAIMED, INCLUDING, WITHOUT LIMITATION, ANY IMPLIED WARRANTIES AND CONDITIONS OF MERCHANTABILITY, SATISFACTORY QUALITY, FITNESS FOR A PARTICULAR PURPOSE, AND NON-INFRINGEMENT. SGI ASSUMES NO RISK AS TO THE QUALITY AND PERFORMANCE OF THE SOFTWARE. SHOULD THE SOFTWARE PROVE DEFECTIVE IN ANY RESPECT, SGI ASSUMES NO COST OR LIABILITY FOR SERVICING, REPAIR OR CORRECTION. THIS DISCLAIMER OF WARRANTY IS AN ESSENTIAL PART OF THIS LICENSE. NO USE OF ANY COVERED CODE IS AUTHORIZED HEREUNDER EXCEPT SUBJECT TO THIS DISCLAIMER.

10. LIMITATION OF LIABILITY. UNDER NO CIRCUMSTANCES NOR LEGAL THEORY, WHETHER TORT (INCLUDING, WITHOUT LIMITATION, NEGLIGENCE OR STRICT LIABILITY), CONTRACT, OR OTHERWISE, SHALL SGI OR ANY SGI LICENSOR BE LIABLE FOR ANY DIRECT, INDIRECT, SPECIAL, INCIDENTAL, OR CONSEQUENTIAL DAMAGES OF ANY CHARACTER INCLUDING, WITHOUT LIMITATION, DAMAGES FOR LOSS OF GOODWILL, WORK STOPPAGE, LOSS OF DATA, COMPUTER FAILURE OR MALFUNCTION, OR ANY AND ALL OTHER COMMERCIAL DAMAGES OR LOSSES, EVEN IF SUCH PARTY SHALL HAVE BEEN INFORMED OF THE POSSIBILITY OF SUCH DAMAGES. THIS LIMITATION OF LIABILITY SHALL NOT APPLY TO LIABILITY FOR DEATH OR PERSONAL INJURY RESULTING FROM SGI'S NEGLIGENCE TO THE EXTENT APPLICABLE LAW PROHIBITS SUCH LIMITATION. SOME JURISDICTIONS DO NOT ALLOW THE EXCLUSION OR LIMITATION OF INCIDENTAL OR CONSEQUENTIAL DAMAGES, SO THAT EXCLUSION AND LIMITATION MAY NOT APPLY TO RECIPIENT.
11. Indemnity. Recipient shall be solely responsible for damages arising, directly or indirectly, out of its utilization of rights under this License. Recipient will defend, indemnify and hold harmless Silicon Graphics, Inc. from and against any loss, liability, damages, costs or expenses (including the payment of reasonable attorneys fees) arising out of Recipient's use, modification, reproduction and distribution of the Covered Code or out of any representation or warranty made by Recipient.
12. U.S. Government End Users. The Covered Code is a "commercial item" consisting of "commercial computer software" as such terms are defined in title 48 of the Code of Federal Regulations and all U.S. Government End Users acquire only the rights set forth in this License and are subject to the terms of this License.
13. Miscellaneous. This License represents the complete agreement concerning the its subject matter. If any provision of this License is held to be unenforceable, such provision shall be reformed so as to achieve as nearly as possible the same legal and economic effect as the original provision and the remainder of this License will remain in effect. This License shall be governed by and construed in accordance with the laws of the United States and the State of California as applied to agreements entered into and to be performed entirely within California between California residents. Any litigation relating to this License shall be subject to the exclusive jurisdiction of the Federal Courts of the Northern District of California (or, absent subject matter jurisdiction in such courts, the courts of the State of California), with venue lying exclusively in Santa Clara County, California, with the losing party responsible for costs, including without limitation, court costs and reasonable attorneys fees and expenses. The application of the United Nations Convention on Contracts for the International Sale of Goods is expressly excluded. Any law or regulation that provides that the language of a contract shall be construed against the drafter shall not apply to this License.

Exhibit A

License Applicability. Except to the extent portions of this file are made subject to an alternative license as permitted in the SGI Free Software License B, Version 1.1 (the "License"), the contents of this file are subject only to the provisions of the License. You may not use this file except in compliance with the License. You may obtain a copy of the License at Silicon Graphics, Inc., attn: Legal Services, 1600 Amphitheatre Parkway, Mountain View, CA 94043-1351, or at:

<http://oss.sgi.com/projects/FreeB>

Note that, as provided in the License, the Software is distributed on an "AS IS" basis, with ALL EXPRESS AND IMPLIED WARRANTIES AND CONDITIONS DISCLAIMED, INCLUDING, WITHOUT LIMITATION, ANY IMPLIED WARRANTIES AND CONDITIONS OF MERCHANTABILITY, SATISFACTORY QUALITY, FITNESS FOR A PARTICULAR PURPOSE, AND NON-INFRINGEMENT.

Original Code. The Original Code is: [name of software, version number, and release date], developed by Silicon Graphics, Inc. The Original Code is Copyright (c) [dates of first publication, as appearing in the Notice in the Original Code] Silicon Graphics, Inc. Copyright in any portions created by third parties is as indicated elsewhere herein. All Rights Reserved.

Additional Notice Provisions: [such additional provisions, if any, as appear in the Notice in the Original Code under the heading "Additional Notice Provisions"]



**P&F USA, Inc.**  
**PO Box 430 Daleville, IN 47334-0430**

**P&F Mexicana, S.A. de C.V.**  
**Av. La Palma No. 6, Col. San Fernando La Herradura,**  
**Huixquilucan Edo. de México C.P. 52787**

**TELEVISOR A COLOR DE CRISTAL LIQUIDO (LCD)**

MODELO	LCD	IMAGEN VISIBLE	ENERGIA
55PFL4706/F7	55"(139,70cm)	138,78cm	120V ~ 60Hz 195W
46PFL4706/F7	46"(116,84cm)	116,81cm	120V ~ 60Hz 150W

Comercializado por : **P&F MEXICANA, S.A. DE C.V.**

IMPORTADOR : **SOJITZ MEXICANA, S.A. DE C.V.**  
Av. Paseo de las Palmas No. 239-302  
Col. Lomas de Chapultepec, C.P. 11000  
México, D.F. Tel. 52 (55) 5202 - 7222

EXPORTADOR : **FUNAI ELECTRIC CO. LTD.**

ENSAMBLADO EN : **MEXICO**

GARANTIA INCLUIDA EN EL INSTRUCTIVO DE USO



**LEA CUIDADOSAMENTE ESTE INSTRUCTIVO  
ANTES DE USAR SU APARATO.**

**TELEVISOR A COLOR DE CRISTAL LIQUIDO (LCD)**

MODELO	LCD	IMAGEN VISIBLE	ENERGIA
40PFL4706/F7	40"(101,60cm)	101,60cm	120V ~ 60Hz 145W

Comercializado por : **P&F MEXICANA, S.A. DE C.V.**

IMPORTADOR : **SOJITZ MEXICANA, S.A. DE C.V.**  
Av. Paseo de las Palmas No. 239-302  
Col. Lomas de Chapultepec, C.P. 11000  
México, D.F. Tel. 52 (55) 5202 - 7222

EXPORTADOR : **FUNAI ELECTRIC CO. LTD.**

PAIS DE ORIGEN : **CHINA**

GARANTIA INCLUIDA EN EL INSTRUCTIVO DE USO



**LEA CUIDADOSAMENTE ESTE INSTRUCTIVO  
ANTES DE USAR SU APARATO.**