

SHARP®

LC-46SV50U

LC-42SV50U

LC-32SV40U

LIQUID CRYSTAL TELEVISION

TÉLÉVISEUR ACL

TELEVISOR CON PANTALLA
DE CRISTAL LÍQUIDO

OPERATION MANUAL

MODE D'EMPLOI

MANUAL DE OPERACIÓN



ENGLISH

FRANÇAIS

ESPAÑOL



IMPORTANT : Please read this operation manual before starting operating the equipment.
IMPORTANT : Veuillez lire ce mode d'emploi avant de commencer à utiliser l'appareil.
IMPORTANTE: Lea este manual de operación antes de comenzar a operar el equipo.

LC-46SV50U

LC-42SV50U

LC-32SV40U

LIQUID CRYSTAL TELEVISION

ENGLISH

OPERATION MANUAL

IMPORTANT:

To aid reporting in case of loss or theft, please record the TV's model and serial numbers in the space provided. The numbers are located at the rear of the TV.

Model No.:

Serial No.:

IMPORTANT INFORMATION

WARNING: TO REDUCE THE RISK OF FIRE OR ELECTRIC SHOCK, DO NOT EXPOSE THIS PRODUCT TO RAIN OR MOISTURE.



CAUTION

RISK OF ELECTRIC SHOCK
DO NOT OPEN



CAUTION: TO REDUCE THE RISK OF ELECTRIC SHOCK,
DO NOT REMOVE COVER (OR BACK).
NO USER-SERVICEABLE PARTS INSIDE.
REFER SERVICING TO QUALIFIED SERVICE
PERSONNEL.



The lightning flash with arrow-head symbol, within an equilateral triangle, is intended to alert the user to the presence of uninsulated "dangerous voltage" within the product's enclosure that may be of sufficient magnitude to constitute a risk of electric shock to persons.



The exclamation point within a triangle presence of important operating and maintenance (servicing) instruction in the literature accompanying the product.

IMPORTANT INFORMATION

CAUTION: TO PREVENT ELECTRIC SHOCK, MATCH WIDE BLADE OF PLUG TO WIDE SLOT, FULLY INSERT.

WARNING: FCC Regulations state that any unauthorized changes or modifications to this equipment not expressly approved by the manufacturer could void the user's authority to operate this equipment.

CAUTION:

This product satisfies FCC regulations when shielded cables and connectors are used to connect the unit to other equipment. To prevent electromagnetic interference with electric appliances such as radios and televisions, use shielded cables and connectors for connections.

This product utilizes fluorescent lamp containing a small amount of mercury. Disposal of these materials may be regulated due to environmental considerations.

For disposal or recycling information, please contact your local authorities, the Electronic Industries Alliance: www.eiae.org, the lamp recycling organization: www.lamprecycle.org or Sharp at 1-800-BE-SHARP (For U.S.A. only)

DECLARATION OF CONFORMITY:

SHARP LIQUID CRYSTAL TELEVISION, MODEL LC-46SV50U / LC-42SV50U / LC-32SV40U
This device complies with Part 15 of the FCC Rules. Operation is subject to the following two conditions: (1) This device may not cause harmful interference, and (2) this device must accept any interference received, including interference that may cause undesired operation.
RESPONSIBLE PARTY:

SHARP ELECTRONICS CORPORATION
Sharp Plaza, Mahwah, New Jersey 07495-1163
TEL: 1-800-BE-SHARP

For Business Customers: URL <http://www.sharppusa.com>

INFORMATION:

This equipment has been tested and found to comply with the limits for a Class B digital device, pursuant to Part 15 of the FCC Rules. These limits are designed to provide reasonable protection against harmful interference in a residential installation. This equipment generates, uses and can radiate radio frequency energy and, if not installed and used in accordance with the instructions, may cause harmful interference to radio communications. However, there is no guarantee that interference will not occur in a particular installation. If this equipment does cause harmful interference to radio or television reception, which can be determined by turning the equipment off and on, the user is encouraged to try to correct the interference by one or more of the following measures:

- Reorient or relocate the receiving antenna.
- Increase the separation between the equipment and receiver.
- Connect the equipment into an outlet on a circuit different from that to which the receiver is connected.
- Consult the dealer or an experienced radio/TV technician for help.

Note to CATV system installer: This reminder is provided to call the CATV system installer's attention to Article 820 of the National Electrical Code that provides guidelines for proper grounding and, in particular, specifies that the cable ground shall be connected to the grounding system of the building, as close to the point of cable entry as practical.

TRADEMARKS

- HDMI, the HDMI logo, and High-Definition Multimedia Interface are trademarks or registered trademarks of HDMI Licensing LLC in the United States and other countries.
- Manufactured under license from Dolby Laboratories. Dolby and the double-D symbol are trademarks of Dolby Laboratories.

DEAR SHARP CUSTOMER

Thank you for your purchase of the Sharp Liquid Crystal Television. To ensure safety and many years of trouble-free operation of your product, please read the Important Safety Instructions carefully before using this product.

IMPORTANT SAFETY INSTRUCTIONS

- 1) Read these instructions.
- 2) Keep these instructions.
- 3) Heed all warnings.
- 4) Follow all instructions.
- 5) Do not use this apparatus near water.
- 6) Clean only with dry cloth.
- 7) Do not block any ventilation openings. Install in accordance with the manufacturer's instructions.
- 8) Do not install near any heat sources such as radiators, heat registers, stoves, or other apparatus (including amplifiers) that produce heat.
- 9) Protect the power cord from being walked on or pinched particularly at plugs, convenience receptacles, and the point where they exit from the apparatus.
- 10) Only use attachments/accessories specified by the manufacturer.
- 11) Use only with the cart, stand, tripod, bracket, or table specified by the manufacturer, or sold with the apparatus. When a cart is used, use caution when moving the cart/apparatus combination to avoid injury from tip-over.
- 12) Unplug this apparatus during lightning storms or when unused for long periods of time.
- 13) Refer all servicing to qualified service personnel. Servicing is required when the apparatus has been damaged in any way, such as power-supply cord or plug is damaged, liquid has been spilled or objects have fallen into the apparatus, the apparatus has been exposed to rain or moisture, does not operate normally, or has been dropped.
- 14) **WARNING:** To reduce the risk of fire or electric shock, do not expose this apparatus to rain or moisture.
- 15) Where the MAINS plug or an appliance coupler is used as the disconnect device, the disconnect device shall remain readily operable.
- 16) The apparatus shall not be exposed to dripping or splashing and that no objects filled with liquids, such as vases, shall be placed on the apparatus.



Additional Safety Information

- 17) **Power Sources**—This product should be operated only from the type of power source indicated on the marking label. If you are not sure of the type of power supply to your home, consult your product dealer or local power company. For products intended to operate from battery power, or other sources, refer to the operating instructions.
- 18) **Overloading**—Do not overload wall outlets, extension cords, or integral convenience receptacles as this can result in a risk of fire or electric shock.
- 19) **Object and Liquid Entry**—Never push objects of any kind into this product through openings as they may touch dangerous voltage points or short-out parts that could result in a fire or electric shock. Never spill liquid of any kind on the product.
- 20) **Damage Requiring Service**—Unplug this product from the wall outlet and refer servicing to qualified service personnel under the following conditions:
 - a) When the AC cord or plug is damaged,
 - b) If liquid has been spilled, or objects have fallen into the product,
 - c) If the product has been exposed to rain or water,
 - d) If the product does not operate normally by following the operating instructions. Adjust only those controls that are covered by the operating instructions as an improper adjustment of other controls may result in damage and will often require extensive work by a qualified technician to restore the product to its normal operation,
 - e) If the product has been dropped or damaged in any way, and
 - f) When the product exhibits a distinct change in performance - this indicates a need for service.

IMPORTANT SAFETY INSTRUCTIONS

- 21) Replacement Parts—When replacement parts are required, be sure the service technician has used replacement parts specified by the manufacturer or have the same characteristics as the original part. Unauthorized substitutions may result in fire, electric shock, or other hazards.
- 22) Safety Check—Upon completion of any service or repairs to this product, ask the service technician to perform safety checks to determine that the product is in proper operating condition.
- 23) Wall or ceiling mounting—Use a wall mount bracket that has been listed by an independent laboratory (such as UL, CSA, ETL).

CAUTION

- These servicing instructions are for use by qualified service personnel only. To reduce the risk of electric shock do not perform any servicing other than that contained in the operating instructions unless you are qualified to do so.

- Outdoor Antenna Grounding — If an outside antenna is connected to the television equipment, be sure the antenna system is grounded so as to provide some protection against voltage surges and built-up static charges.

Article 810 of the National Electrical Code, ANSI/NFPA 70, provides information with regard to proper grounding of the mast and supporting structure, grounding of the lead-in wire to an antenna discharge unit, size of grounding conductors, location of antenna-discharge unit, connection to grounding electrodes, and requirements for the grounding electrode.

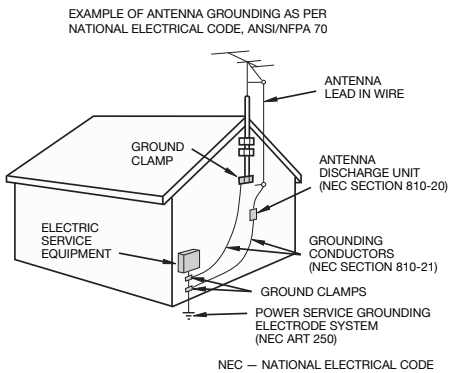

- Warning statement indicating that Class I apparatus shall be connected to a mains socket outlet with a protective earthing connection.
- Statement indicating that when the mains plug or appliance coupler shall remain readily operable.
- Where the MAINS plug or an appliance coupler is used as the disconnect device, the disconnect device shall remain readily operable.
- Where an all-pole MAINS SWITCH is used as the disconnect device, the location on the apparatus and the function of the switch shall be described, and the switch shall remain readily operable.
- Water and Moisture — Do not use this product near water - for example, near a bath tub, wash bowl, kitchen sink, or laundry tub; in a wet basement; or near a swimming pool; and the like.
- Stand — Do not place the product on an unstable cart, stand, tripod or table. Placing the product on an unstable base can cause the product to fall, resulting in serious personal injuries as well as damage to the product. Use only a cart, stand, tripod, bracket or table recommended by the manufacturer or sold with the product. When mounting the product on a wall, be sure to follow the manufacturer's instructions. Use only the mounting hardware recommended by the manufacturer.
- Selecting the location — Select a place with no direct sunlight and good ventilation.
- Ventilation — The vents and other openings in the cabinet are designed for ventilation. Do not cover or block these vents and openings since insufficient ventilation can cause overheating and/or shorten the life of the product. Do not place the product on a bed, sofa, rug or other similar surface, since they can block ventilation openings. This product is not designed for built-in installation; do not place the product in an enclosed place such as a bookcase or rack, unless proper ventilation is provided or the manufacturer's instructions are followed.
- The Liquid Crystal panel used in this product is made of glass. Therefore, it can break when the product is dropped or applied with impact. Be careful not to be injured by broken glass pieces in case the panel breaks.

IMPORTANT SAFETY INSTRUCTIONS

- Heat — The product should be situated away from heat sources such as radiators, heat registers, stoves, or other products (including amplifiers) that produce heat.
- The Liquid Crystal panel is a very high technology product with 2,073,600 pixels (LC-46SV50U / LC-42SV50U) / 1,049,088 pixels (LC-32SV40U) , giving you fine picture details. Occasionally, a few non-active pixels may appear on the screen as a fixed point of blue, green or red. Please note that this does not affect the performance of your product.
- Lightning — For added protection for this television equipment during a lightning storm, or when it is left unattended and unused for long periods of time, unplug it from the wall outlet and disconnect the antenna. This will prevent damage to the equipment due to lightning and power-line surges.
- Power Lines — An outside antenna system should not be located in the vicinity of overhead power lines or other electric light or power circuits, or where it can fall into such power lines or circuits. When installing an outside antenna system, extreme care should be taken to keep from touching such power lines or circuits as contact with them might be fatal.
- To prevent fire, never place any type of candle or flames on the top or near the TV set.
- To prevent fire or shock hazard, do not place the AC cord under the TV set or other heavy items.
- Do not display a still picture for a long time, as this could cause an afterimage to remain.
- To prevent fire or shock hazard, do not expose this product to dripping or splashing.
No objects filled with liquids, such as vases, should be placed on the product.
- Do not insert foreign objects into the product. Inserting objects in the air vents or other openings may result in fire or electric shock. Exercise special caution when using the product around children.

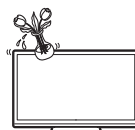

Precautions when transporting the TV

- When transporting the TV, never carry it by holding or otherwise putting pressure onto the display. Be sure to always carry the TV by two people holding it with two hands — one hand on each side of the TV.

Caring for the Cabinet

- Use a soft cloth (cotton, flannel, etc.) and gently wipe the surface of the cabinet.
- Using a chemical cloth (wet/dry sheet type cloth, etc.) may deform the components of the main unit cabinet or cause cracking.
- Wiping with a hard cloth or using strong force may scratch the surface of the cabinet.
- If the cabinet is very dirty, wipe with a soft cloth (cotton, flannel, etc.) soaked in neutral detergent diluted with water and thoroughly wrung out, and then wipe with a soft dry cloth.
- The cabinet is primarily made of plastic. Avoid using benzene, thinner, and other solvents, as these may deform the cabinet and cause the paint to peel off.
- Do not apply insecticides or other volatile liquids.

Also, do not allow the cabinet to remain in contact with rubber or vinyl products for a long period of time. Plasticizers inside the plastic may cause the cabinet to deform and cause the paint to peel off.

Caring for the Liquid Crystal panel

- Turn off the main power and unplug the AC cord from the wall outlet before handling.
- Gently wipe the surface of the display panel with a soft cloth (cotton, flannel, etc.). To protect the display panel, do not use a dirty cloth, liquid cleaners, or a chemical cloth (wet/ dry sheet type cloth, etc.). This may damage the surface of the display panel.
- Wiping with a hard cloth or using strong force may scratch the surface of the display panel.
- Use a soft damp cloth to gently wipe the display panel when it is really dirty. (It may scratch the surface of the display panel when wiped strongly.)
- If the display panel is dusty, use an anti-static brush, which is commercially available, to clean it.
- To avoid scratching the frame or screen, please use a soft, lint free cloth for cleaning. Approved cleaning cloths are available directly from Sharp in single (00Z-LCD-CLOTH) or triple (00Z-LCD-CLOTH-3) packs.

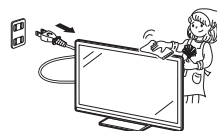

Call 1-800-BE-SHARP for ordering, or VISIT <http://www.sharppusa.com/SharpDirect>.

IMPORTANT SAFETY INSTRUCTIONS

CHILD SAFETY

It Makes A Difference How and Where You Use Your Flat Panel Display

Congratulations on your purchase! As you enjoy your new product, please keep these safety tips in mind:



THE ISSUE

- The home theater entertainment experience is a growing trend and larger flat panel displays are popular purchases. However, flat panel displays are not always supported on the proper stands or installed according to the manufacturer's recommendations.
- Flat panel displays that are inappropriately situated on dressers, bookcases, shelves, desks, speakers, chests or carts may fall over and cause injury.

THIS MANUFACTURER CARES!

- The consumer electronics industry is committed to making home entertainment enjoyable and safe.

TUNE INTO SAFETY

- One size does NOT fit all. Follow the manufacturer's recommendations for the safe installation and use of your flat panel display.
- Carefully read and understand all enclosed instructions for proper use of this product.
- Don't allow children to climb on or play with furniture and television sets.
- Don't place flat panel displays on furniture that can easily be used as steps, such as a chest of drawers.
- Remember that children can become excited while watching a program, especially on a "larger than life" flat panel display. Care should be taken to place or install the display where it cannot be pushed, pulled over, or knocked down.
- Care should be taken to route all cords and cables connected to the flat panel display so that they cannot be pulled or grabbed by curious children.



WALL MOUNTING: IF YOU DECIDE TO WALL MOUNT YOUR FLAT PANEL DISPLAY, ALWAYS:

- Follow all instructions supplied by the display and wall mount manufacturers.
- If you have any doubts about your ability to safely install your flat panel display, contact your retailer about professional installation.
- Make sure that the wall where you are mounting the display is appropriate. Some wall mounts are not designed to be mounted to walls with steel studs or old cinder block construction. If you are unsure, contact a professional installer.
- A minimum of two people are required for installation. Flat panel displays can be heavy.



Note: CEA is the preeminent trade association promoting growth in the \$161 billion U.S. consumer electronics industry. More than 2,200 companies enjoy the benefits of CEA membership, including legislative advocacy, market research, technical training and education, industry promotion and the fostering of business and strategic relationships.

QUICK REFERENCE

Supplied Accessories

Make sure the following accessories are provided with the product.



Remote control unit
(x 1)
Page 10



"AAA" size battery
(x 2)
Page 12



Stand (x 1)
with Screws
Page 7



Operation manual
(x 1)

NOTE

- Always use the AC cord supplied with the TV.
- The illustrations above are for explanation purposes and may vary slightly from the actual accessories.

Attaching/Detaching the Stand

- Before attaching (or detaching) the stand, unplug the AC cord from the AC INPUT terminal.
- Before performing work spread cushioning over the base area to lay the TV on. This will prevent it from being damaged.

CAUTION

- **Attach the stand in the correct direction.**
- **Be sure to follow the instructions. Incorrect installation of the stand may result in the TV falling over.**

1. Put the TV face down on a safe surface that is covered by a soft and smooth cloth.
2. Adjust the TV stand to the bottom of the TV.
3. Fasten the screws by using a cross-head screwdriver (Not supplied).

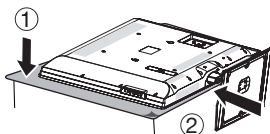

LC-46SV50

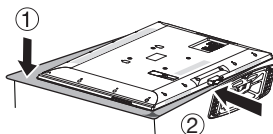

LC-42SV50

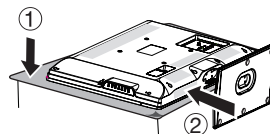

LC-32SV40U

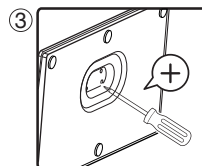
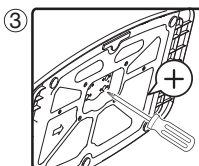
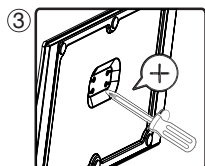

CAUTION

- **Do not push too hard or put excessive pressure to the stand neck to avoid the damages when you turn the TV for the most comfortable viewing angle.**

NOTE

- To detach the stand, perform the steps in reverse order.

QUICK REFERENCE

Detaching the stand neck for wall mounting

CAUTION

- Please use care when disassembling cabinet, stand, and pillar for wall mounting.
 - Detach the stand neck in the correct direction.
 - Do not remove the stand neck from the TV unless using an optional wall mount bracket to mount it.
1. Loosen the 4 screws that secure the stand neck by using a cross-head screwdriver.
Remove stand cover from the TV set.

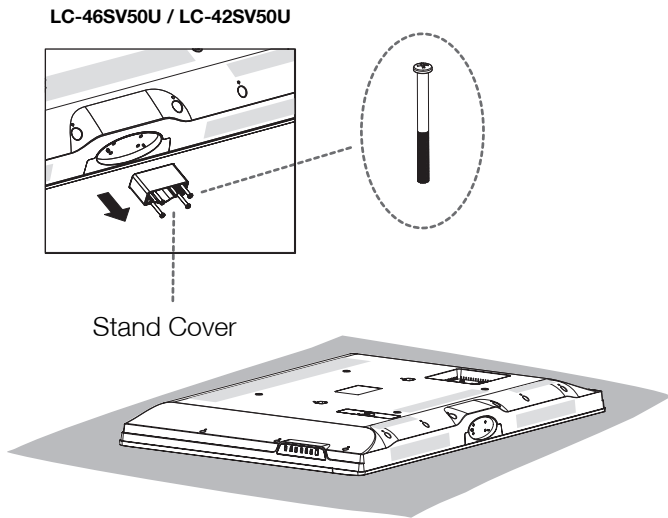

NOTE

- To attach the stand neck, perform the steps in reverse order.
- Do not force or overtighten and do not install without stand covers.

QUICK REFERENCE

Quick Installation Tips

1. Attach your antenna to the back of the television. (See page 11.)
2. Connect the AC plug for the television into the AC outlet.

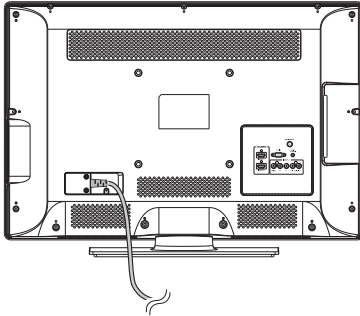

- Place the TV close to the AC outlet, and keep the power plug within reach.
- This product must only be connected to a 120V, 60Hz AC outlet. Connecting it to any other kind of outlet will damage the product and invalidate the warranty.

NOTE

- **TO PREVENT RISK OF ELECTRIC SHOCK, DO NOT TOUCH UN-INSULATED PARTS OF ANY CABLES WITH THE AC CORD CONNECTED.**

3. How to turn on the television for the first time.
 - A) Press **POWER** on the television.
 - B) The POWER indicator on the front of the television lights Green.

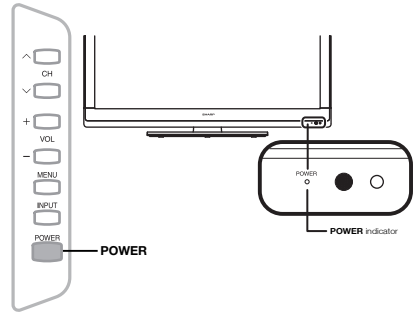

NOTE

- Speakers cannot be detached from the TV.
4. Insert the batteries into the remote control unit. (See page 12.)

QUICK REFERENCE

Using the Remote Control Unit

Use the remote control unit by pointing it towards the remote control sensor on the TV. Objects between the remote control unit and the remote control sensor may prevent proper operation.

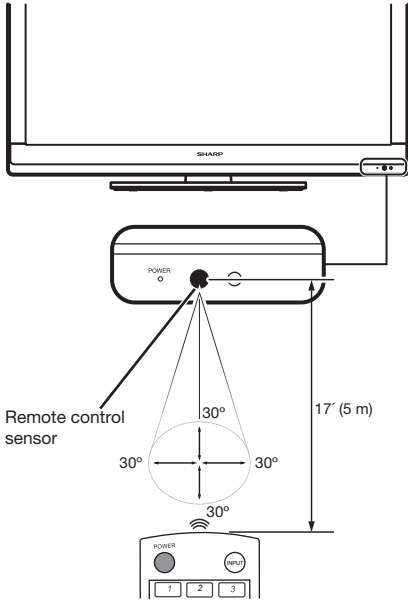

■ Cautions regarding the remote control unit

- Do not expose the remote control unit to shock. In addition, do not expose the remote control unit to liquids, and do not place in an area with high humidity.
- Do not install or place the remote control unit under direct sunlight. The heat may cause deformation of the remote control unit.
- The remote control unit may not work properly if the remote control sensor on the TV is under direct sunlight or strong lighting. In such cases, change the angle of the lighting or the TV, or operate the remote control unit closer to the remote control sensor.



IMPORTANT:

IF THE UNIT DOES NOT POWER ON - UNPLUG THE TELEVISION FROM THE OUTLET AND REPEAT THE INSTALLATION STEPS.

IF YOU STILL ENCOUNTER NO POWER, PLEASE CONTACT US AT 1-800-BE-SHARP.

Preparation

Antennas

To enjoy a clearer picture, use an outdoor antenna. The following is a brief explanation of the types of connections that are used for a coaxial cable. If your outdoor antenna uses a 75-ohm coaxial cable with an F-type connector, plug it into the antenna terminal at the rear of the TV set.

1. A 75-ohm system is generally a round cable with F-type connector that can easily be attached to a terminal without tools (Commercially available).
2. A 300-ohm system is a flat "twin-lead" cable that can be attached to a 75-ohm terminal through a 300/75-ohm adapter (Commercially available).

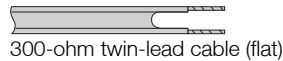
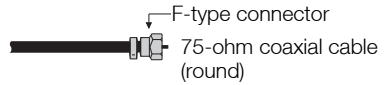

NOTE

When connecting the RF cable to the TV set, do not tighten F-type connector with tools. If tools are used, it may cause damage to your TV set. (The breaking of internal circuit, etc.)

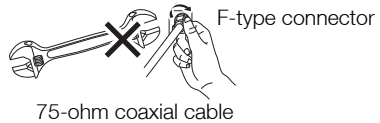

Connecting Antenna Cable

- Connect the antenna cable to the TV using one of the methods in the illustration as shown (①, ②, ③ or ④).

- ① Cable without a CATV converter



- ② VHF/UHF antenna



- ③ Combination VHF/UHF antenna

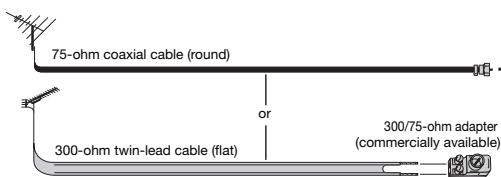

- ④ Separate VHF/UHF antenna

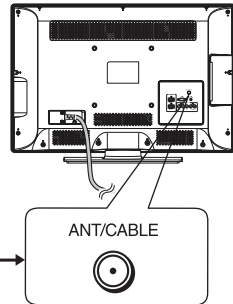
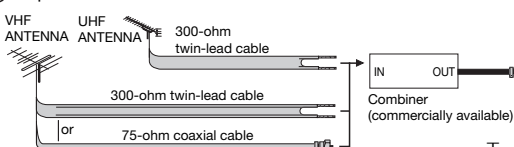

To TV antenna terminal

Preparation

Installing Batteries in the Remote Control Unit

If the remote control fails to operate TV functions, replace the batteries in the remote control unit.

1 Open the battery cover.

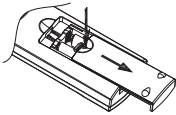

3 Close the battery cover.

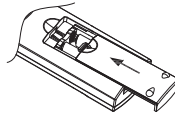

2 Insert two “AAA” size batteries (supplied with the product).

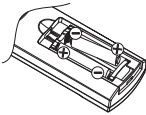

- Place the batteries with their terminals corresponding to the (+) and (-) indications in the battery compartment.

CAUTION

Improper use of batteries can result in chemical leakage or explosion. Be sure to follow the instructions below.

- Do not mix batteries of different types. Different types of batteries have different characteristics.
- Do not mix old and new batteries. Mixing old and new batteries can shorten the life of new batteries or cause chemical leakage in old batteries.
- Remove batteries as soon as they are worn out. Chemicals that leak from batteries come in contact with skin can cause a rash. If you find any chemical leakage, wipe thoroughly with a cloth.
- The batteries supplied with this product may have a shorter life expectancy due to storage conditions.
- If you will not be using the remote control unit for an extended period of time, remove batteries from it.
- The batteries (batteries installed) shall not be exposed to excessive heat such as sunshine, fire or the like.

Contents

IMPORTANT INFORMATION	1
TRADEMARKS	2
IMPORTANT SAFETY INSTRUCTIONS	3
QUICK REFERENCE	7
Supplied Accessories	7
Attaching/Detaching the Stand	7
Detaching the stand neck for wall mounting	8
Quick Installation Tips	9
Using the Remote Control Unit	10
Antennas	11
Connecting Antenna Cable	11
Installing Batteries in the Remote Control Unit	12
Contents	13
Part Names	14
TV (Front)	14
TV (Side/Rear)	14
Remote Control Unit	15
Introduction to Connections	16
Experiencing HD Images	16
Types of Connection	16
Connecting to External Equipment	17
Connecting a Blu-ray Disc/DVD Player or HD Cable/Satellite Set-top Box	17
Connecting a Game Console, VCR, Camcorder or Cable/Satellite Set-top Box	18
Connecting an Audio Amplifier	19
Connecting an AV Amplifier	19
Connecting a PC	20
Watching TV	21
Turning On/Off the Power	21
EZ Setup	21
Direct Button Operation	23
On-Screen Display Menu	26
Menu Items	26
On-Screen Display Menu Operation	27
Menu Operation Button	28
Picture Settings	28
Audio Settings	30
Power Control	30
System Options	31
Initial Setup	33
Information	36
Enjoying Photo/Music/Video Playback	37
Appendix	40
Troubleshooting	40
Specifications	41
PC Compatibility Chart	43
RS232 Port Specifications	44
Information on the Software License for This Product	45
Legal notices	46
Calling for Service	47
LIMITED WARRANTY	47

Dimensional Drawings

- The dimensional drawings for the LCD TV set are shown on the inside back cover.

Part Names

TV (Front)

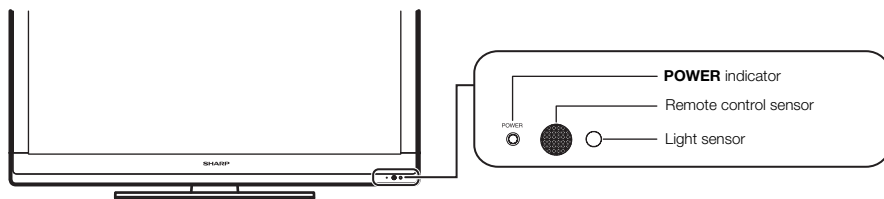

TV (Side/Rear)

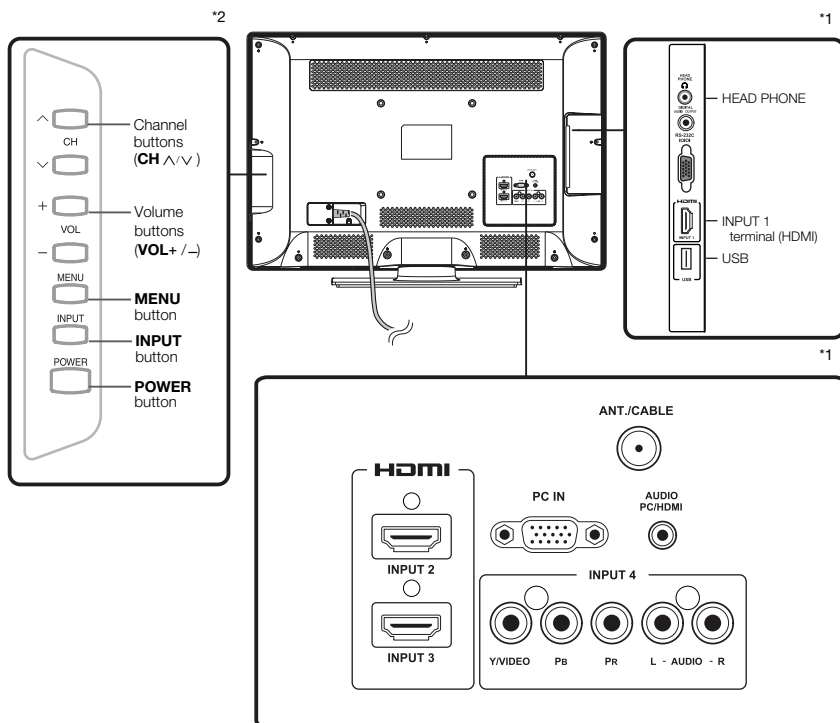

*1: See pages 17, 18, 19 and 20 for external equipment connection.

*2: See page 16, 21, 23 and 28 for button operations.

NOTE

- The illustrations in this operation manual are for explanation purposes and may vary slightly from the actual operations.

Part Names

Remote Control Unit

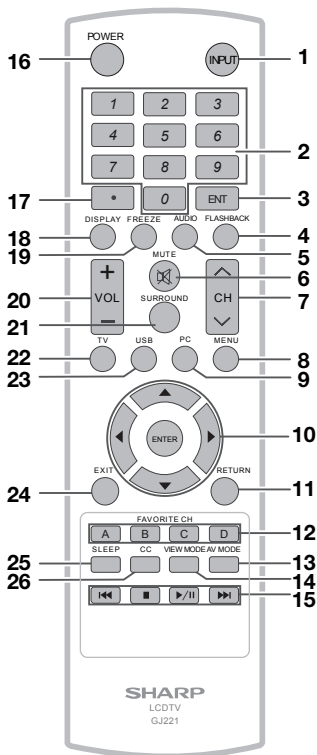

NOTE

- When using the remote control unit, point it at the TV.

- INPUT:** Select a TV input source. (See page 23.)
- 0-9:** Set the channel.
- ENT:** Jumps to a channel after selecting with the 0-9 buttons.
- FLASHBACK:** Press to switch to the previously tuned channel or external input mode. Press again to switch back to the currently tuned channel or external input mode.
- AUDIO:** Display the MTS/SAP setting menu. (See page 24.)
- MUTE:** Mute the sound. (See page 23.)
- CH \wedge/\vee :** Select the channel. (See page 23.)
- MENU:** Display the menu screen.
- PC:** Direct switch PC source.
- $\blacktriangle/\blacktriangledown/\blacktriangleleft/\blacktriangleright$, ENTER:** Select a desired item on the screen. (See page 28.)
- RETURN:** Return to the previous menu screen.
- FAVORITE CH:**
 - A,B,C,D:** Selects preset favorite channels in four different categories. While watching, you can toggle the selected channels by pressing **A, B, C** and **D**. The every key of the favorite can select the many channels.
- AV MODE:** Select an adjusted picture settings. User, Standard, Movie, Game, PC, Dynamic, Dynamic(Fixed). (See page 24.)
- VIEW MODE:** Select the Picture Mode. (See page 25.)
- \lll \square \ggg \square :** Only for USB.
- POWER:** Switch the power on or enters standby mode. (See page 21.)
- (DOT):** (See page 23.)
- DISPLAY:** Display the current channel (or input source) information on the screen.
- FREEZE:** Set the still image. Press again to return to normal screen.
- VOL +/- :** Set the volume. (See page 23.)
- SURROUND:** Display the surround setting menu. (See page 23.)
- TV:** Direct switch TV source.
- USB:** Direct switch USB source.
- EXIT:** Turn off the menu screen.
- SLEEP:** Allows you to set a time when the TV automatically switches to standby. This display will disappear after a few seconds, and the sleep timer automatically starts counting down. (See page 23.)
- CC:** Display captions during closed-caption source. (See page 24.)

Introduction to Connections

Experiencing HD Images

An HDTV without an HD source is just an ordinary TV.

To enjoy HD images on the TV, you should get HD programming from the following:

- Over-the-air broadcasting via HD quality antenna
- HD cable/satellite subscription
- HD compatible external equipment

NOTE

- For information on updating to HD programming, ask your cable/satellite service provider.

Types of Connection

Image quality differs depending on the terminal used. To enjoy clearer images, check the output terminals of your external equipment and use its appropriate terminals for higher quality images. For connecting the TV to external equipment, use commercially available cables.

- The illustrations of the terminals are for explanation purposes and may vary slightly from the actual products.

Image Quality	Terminal on external equipment	Cable	Terminal on the TV	
	 HDMI	 HDMI-certified cable	INPUT 1, 2, 3 HDMI	→ Page 17
	 AUDIO DVI OUT	 Ø 3.5 mm stereo minijack cable DVI-HDMI conversion cable	AUDIO PC/VIDEO INPUT 1, 2, 3 HDMI	→ Page 17
	 Y Pb Pr COMPONENT L R AUDIO	Component video cable (commercially available) Audio cable (commercially available) 	INPUT 4 VIDEO Pb Pr L-AUDIO +R	→ Page 18
	 VIDEO AUDIO	AV cable (commercially available) 	INPUT 4 VIDEO Pb Pr L-AUDIO +R	→ Page 18

Displaying an External Equipment Image Display

To view external source images, select the input source by pressing **INPUT** on the remote control or on the TV.

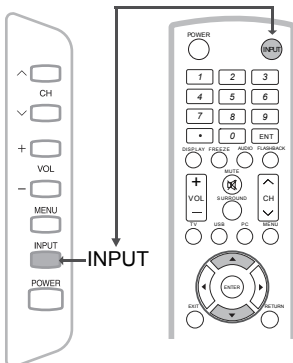

Example

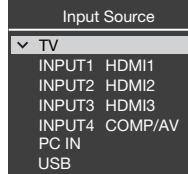

1. Press **INPUT**.
 - The CH list screen displays.
 2. Press **▲/▼** to select the input source.
 - You can also select the input source by pressing **INPUT**. Each time **INPUT** is pressed, the input source toggles.
- INPUT1 → INPUT2 → INPUT3
 ↑
 TV ← ----- INPUT4
- An image from the selected source automatically displays.

Connecting to External Equipment

You can connect many types of external equipment to your TV. To view external source images, select the input source from **INPUT** on the remote control unit or on the TV. (See pages 15 and 23.) For connecting the TV to external equipment, use commercially available cables.

CAUTION

- To protect equipment, always turn off the TV before connecting any external equipment.
- Please read the relevant operation manual (Blu-ray disc player, etc.) carefully before making connections.

Connecting a Blu-ray Disc/DVD Player or HD Cable/Satellite Set-top Box

■ When using HDMI cable (INPUT 1, 2, or 3):

The HDMI (High Definition Multimedia Interface) terminal is an audio-video interface that enables a connection for audio and video signals using a single cable. The HDMI terminal supports high-resolution video input.

- Blu-ray disc player
- DVD player
- HD cable/satellite set-top box

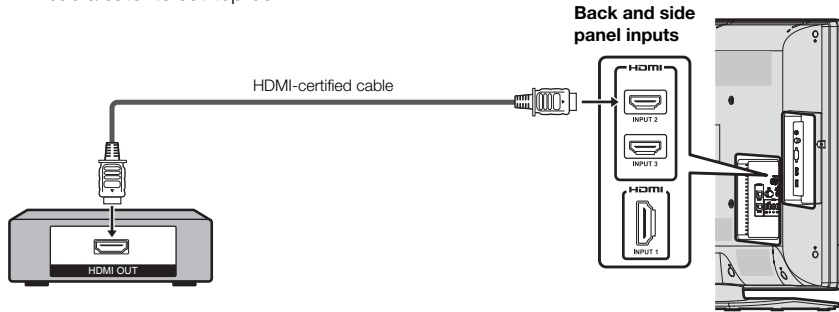

NOTE

- To enjoy 1080p display capability, connect your external equipment using an HDMI-certified cable or a component cable and set the equipment to 1080p output.
- Supported Audio format: Linear PCM, sampling rate 32/44.1/48kHz.

■ When using DVI-HDMI conversion cable (INPUT 1, 2, or 3):

- Blu-ray disc player
- DVD player
- HD cable/satellite set-top box

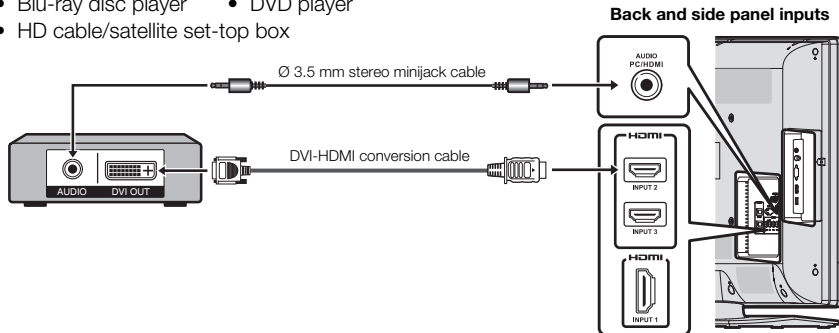

NOTE

- When using a DVI-HDMI conversion cable, you should make an analog audio connection. In this case, in addition to connecting a DVI-HDMI conversion cable to the INPUT 1,2,3 (HDMI) terminal, connect a Ø 3.5 mm stereo minijack cable to the AUDIO PC/HDMI terminal.

Connecting to External Equipment

■ When using Component cable (INPUT 4):

- Blu-ray disc player • DVD player
- HD cable/satellite set-top box

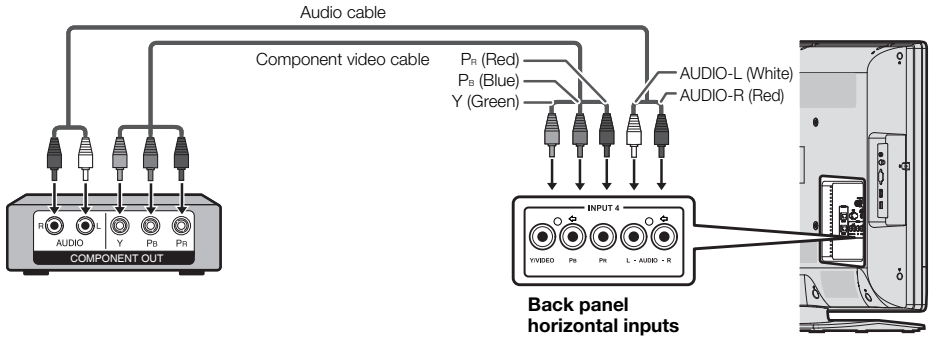

NOTE

- To enjoy 1080p display capability, connect your external equipment using an HDMI-certified cable or a component cable and set the equipment to 1080p output.
- See page 17 for connecting a Blu-ray disc player, DVD player or an HD cable/satellite set-top box to the HDMI terminal.

Connecting a Game Console, VCR, Camcorder or Cable/Satellite Set-top Box

■ When using Composite cable (INPUT 4):

- Game console • VCR
- Camcorder • Cable/Satellite set-top box

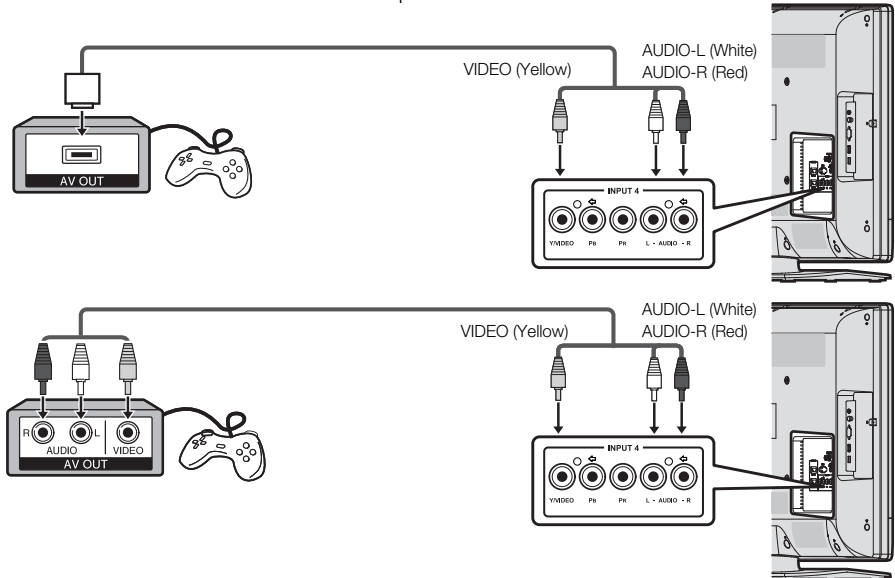

Connecting to External Equipment

Connecting an Audio Amplifier

■ When using coaxial cable:

It is possible to output audio through the DIGITAL AUDIO terminal. PCM audio outputs from the terminal.

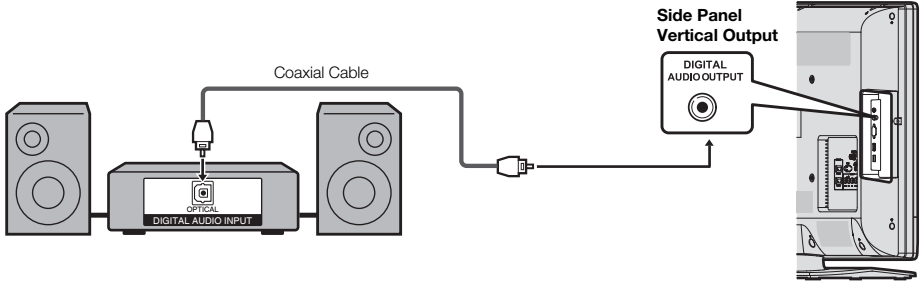

NOTE

- Digital Audio output is not available when using an HDMI input.

Connecting an AV Amplifier

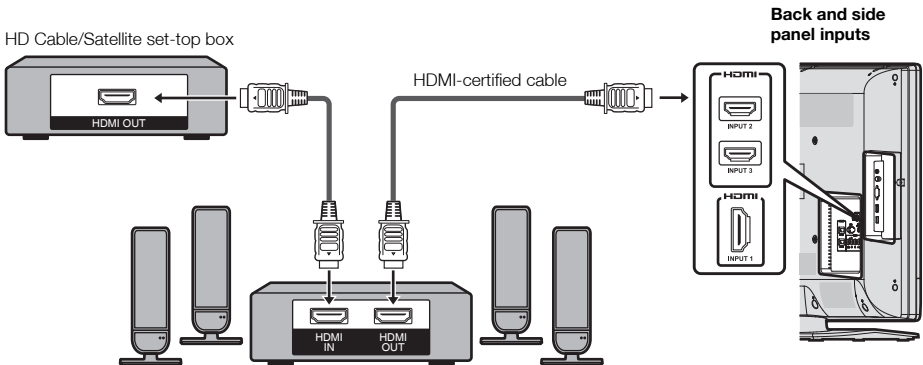

NOTE

- If the image is not in sync with the audio, check the settings of the connected surround system.
- Letting the TV output the audio to an AV amplifier.

Connecting to External Equipment

Connecting a PC

Refer to page 43 for a list of PC signals compatible with the TV.

■ When using HDMI cable (INPUT 1, 2 or 3):

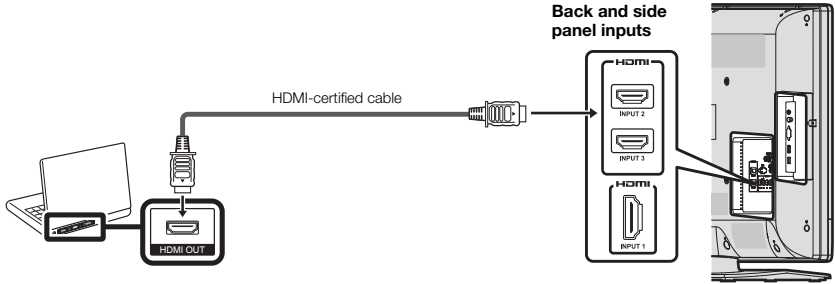

NOTE

- The HDMI terminals only support digital signal.

■ When using DVI-HDMI conversion cable (INPUT 1,2,3):

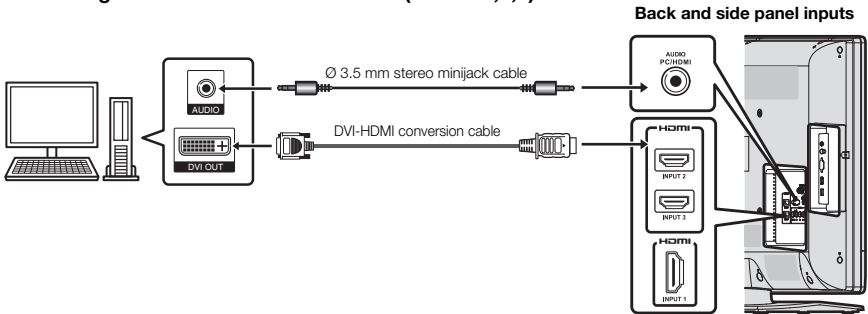

NOTE

- When using a DVI-HDMI conversion cable, you should make an analog audio connection. In this case, in addition to connecting a DVI-HDMI conversion cable to the INPUT 1,2,3 (HDMI) terminal, connect a \varnothing 3.5 mm stereo minijack cable to the AUDIO PC/HDMI terminal.

■ When using analog RGB cable (PC IN):

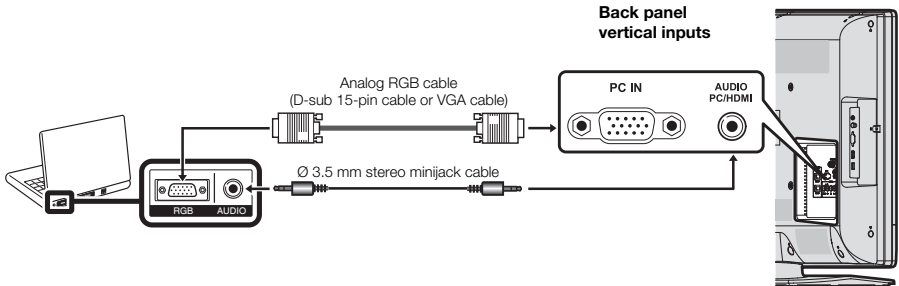

NOTE

- When using an analog RGB cable, input the audio signal to the AUDIO PC/HDMI terminal of PC IN.

Watching TV

Turning On/Off the Power

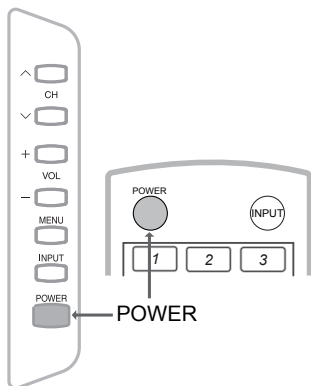

Press **POWER** on the TV, or **POWER** on the remote control unit to turn the power on.

- POWER indicator: Power on, Green; Power off, red.

Press **POWER** on the TV, or **POWER** on the remote control unit again to turn the power off.

- The TV enters standby and the image on the screen disappears.

NOTE

- If you are not going to use this TV for a long period of time, be sure to remove the AC cord from the AC outlet.
- Small amount of electric power is still consumed even when the TV is turned off.
- If there is no signal input for 15 minutes, the power will turn to standby mode automatically.

EZ Setup

When you turn on the TV for the first time, the Initial Setup will guide you through the setup process. Perform the following steps before you press **POWER** on the remote control unit.

1. Insert the batteries into the remote control unit. (See page 12.)
2. Connect the antenna cable to the TV. (See page 11.)
3. Plug in the AC cord to the AC outlet. (See page 9.)

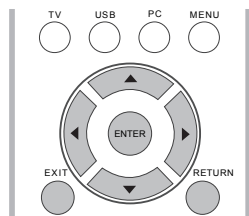

1. Initial Setup

- The Initial Setup screen display at the first use. Press **ENTER** to start the EZ setup.

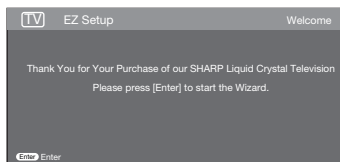

2. Language setting

- Select the OSD menu language from English, Spanish, or French.
- Press **▲/▼** to select the desired language listed on the screen, and then press the **▶** to the next step.

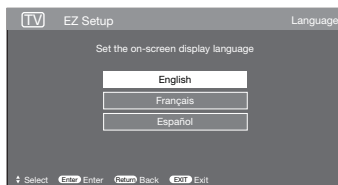

TV Location

Select "Home" or "Store" for the location where you plan to install the TV.

3. Location setting

- Press **▲/▼** to select "Home" or "Store" and press **▶** to the next step.

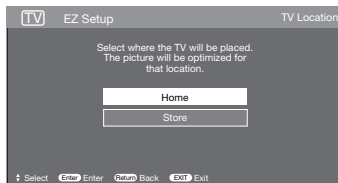

Watching TV

Home: "Power Saving" is set to "On", and AV MODE is set to "STANDARD".

Store: "Power Saving" is set to "Off" and AV MODE is set to "DYNAMIC (Fixed)". Picture Reset and Feature Demo can be set.

4. Air/Cable(Antenna setting)

- Make sure what kind of connection is made with your TV when selecting "Air" or "Cable".
- Press ▲/▼ to select "Air" or "Cable" and press ► to the next step.

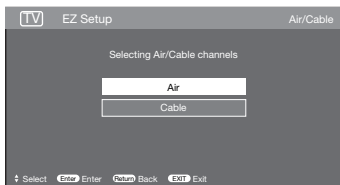

CH Search (Channel search)

Channel auto search makes the TV look for all channels viewable in the set area.

5. When "Air" or "Cable" is selected in Antenna setting:

Press ▲/▼ to select "Start", and then press **ENTER**.

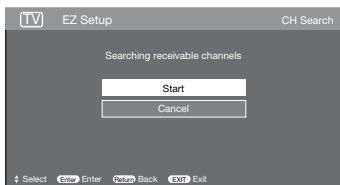

6. Start channel searching

- Wait until the channel scan to complete.
- If you press **EXIT**, the process will return to the previous step.
- If you skip this step, the channel search can be performed in the TV Menu. (See page 34.)

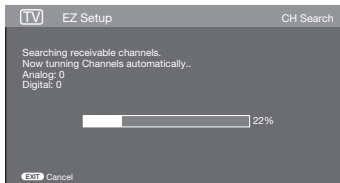

7. Completed

After setting complete, the screen will show "EZ Setup Completed", press **ENTER** to finish the EZ Setup. The TV will then switch to the first channel found.

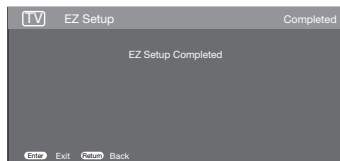

NOTE

- Auto programming may take 20+ minutes to complete. Please wait until you see the Auto programming complete message.

Direct Button Operation

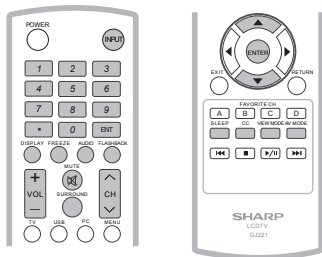

Changing Channels

You can change channels by pressing **CH** \wedge / \vee or **0-9**, or **• (DOT)**.

Examples:

To select a 1 or 2-digit channel number

(e. g., Channel 5):

Press **5** \rightarrow **ENT**.

To select a 3-digit channel number

(e. g., Channel 115):

Press **1** \rightarrow **1** \rightarrow **5** \rightarrow **ENT**.

To select a 4-digit channel number

(e. g., Channel 22.1):

Press **2** \rightarrow **2** \rightarrow **• (DOT)** \rightarrow **1** \rightarrow **ENT**.

NOTE

- When selecting a 1-digit channel number, it is not necessary to press **0** before the number.

Changing Volume

You can change the volume by pressing **VOL** $+$ / $-$ on the TV or on the remote control unit.

- To increase the volume, press **VOL** $+$.
- To decrease the volume, press **VOL** $-$.

INPUT

To view external source images, select the input source using **INPUT** on the remote control unit or **INPUT** on the TV.

1. Press **INPUT**.

- A list of selectable sources appears.

2. Press **INPUT** again to select the input source.

- An image from the selected source automatically displays.
- Each time **INPUT** is pressed, the input source toggles.
- If you press \blacktriangle / \blacktriangledown to select the input source, press **ENTER** to confirm your selection.

NOTE

- See page 17-20 for external equipment connection.

MUTE

Mutes the current sound output.

Press **MUTE**.

NOTE

- Mute can be canceled by using the method below.
 - Mute will be canceled if you press **VOL** $+$ / $-$ or **MUTE**.

SLEEP

Allows you to set a time when the TV automatically switches to standby.

Press **SLEEP**.

- The remaining time displays when the sleep timer has been set.
- Each time you press **SLEEP**, the remaining time switches as shown below.
Off \rightarrow 30 \rightarrow 60 \rightarrow 90 \rightarrow 120
- When set, the time automatically starts counting down.
- If you want to adjust the sleep timer, you can press **SLEEP** twice then change the time setting.

NOTE

- Select "Off" by pressing **SLEEP** to cancel the sleep timer.
- The TV will enter standby mode (power indicator lights red) when the remaining time reaches zero.

FLASHBACK

Press **FLASHBACK** to switch to the previously tuned channel or input.

- Press **FLASHBACK** again to switch back to the currently tuned channel or input.

SURROUND

The surround function produces Surround effect from the speakers. Each time you press **SURROUND**, the mode changes between On and Off.

- On:** Makes it possible to enjoy natural, realistic surround sound.
- Off:** Outputs the normal sound.

NOTE

- You can have the same settings by choosing "Surround" on the menu items. (See page 30.)

FREEZE

Allows you to capture and freeze a moving image that you are watching.

Press **FREEZE**.

- A moving image is captured.
- Press **FREEZE** again to cancel the function.

Direct Button Operation

AV MODE

AV MODE gives you several viewing options to choose from to best match the surrounding environment of the TV, which can vary due to factors like room brightness, type of program watched or the type of image input from external equipment.

Press **AV MODE**. Current AV MODE displays.

- Press **AV MODE** again before the mode displayed on the screen disappears.

AUDIO

■ MTS/SAP stereo mode

The TV has a feature that allows reception of sound other than the main audio for the program. This feature is called Multi-channel Television Sound (MTS). The TV with MTS can receive mono sound, stereo sound and Secondary Audio Programs (SAP). The SAP feature allows a TV station to broadcast other information, which could be audio in another language or something completely different like weather information.

You can enjoy Hi-Fi stereo sound or SAP broadcasts when available.

- **Stereo broadcasts:** View programs like live sporting events, shows and concerts in dynamic stereo sound.
- **SAP broadcasts:** Receive TV broadcasts in either MAIN or SAP sound.

MAIN sound: The normal program soundtrack (either in mono or stereo).

SAP sound: Listen to a second language, supplementary commentary or other information. (SAP is mono sound.)

If stereo sound is difficult to hear.

- Obtain a clearer sound by manually switching to fixed mono-sound mode.

You can change MTS as shown below to match the television broadcast signal.

Press **AUDIO** to toggle between audio modes.

Examples: when receiving MTS and SAP

MAIN + SAP mode: MAIN \longleftrightarrow SAP

MONO mode: MONO

■ Digital broadcasting audio mode

The types of audio transmitted in a digital broadcast include SURROUND as well as MONO and STEREO. In addition, it is possible for multiple audio tracks to accompany a single video track.

Press **MTS/SAP** to toggle between audio modes.

Example: when receiving Digital broadcasting

STEREO (Audio1) \rightarrow STEREO (Audio2)

\leftarrow SURROUND (Audio3) \leftarrow

NOTE

- MTS only operates while in TV mode.

Closed Captions (CC)

Your TV is equipped with an internal Closed Caption decoder. It allows you to view conversations, narration and sound effects as subtitles on your TV. Closed Captions are available on some TV programs and on some VHS home video tapes at the discretion of the program provider.

Digital Closed Caption service is a new caption service available only on digital TV programs (also at the discretion of the service provider). It is a more flexible system than the original Closed Caption system, because it allows for a variety of caption sizes and font styles. When the Digital Closed Caption service is in use, it will be indicated by the appearance of a 3-letter abbreviation that also indicates the language of the Digital Closed Captions: ENG (English), SPA (Spanish), FRA (French) or other language codes.

Not all programs and VHS videotapes offer closed captions.

In the Closed Caption system, there can be more than one caption service provided. Each is identified by its own number. The "CC1" to "CC4" services display subtitles of TV programs superimposed over the program's picture. In the Closed Caption system, the "TEXT1" to "TEXT4" services display text that is unrelated to the program being viewed (e.g., weather or news). These services are also superimposed over the program currently being viewed.

1. Press **CC**.

- This will display the current Closed Caption information. Press **CC** to turn the Closed Caption on or off.

Example:

Analogue:

CC1 \rightarrow CC2 \rightarrow CC3 \rightarrow CC4 \rightarrow TT1
 \uparrow \leftarrow TT4 \leftarrow TT3 \leftarrow TT2 \downarrow

Digital:

CC1 \rightarrow CC2 \rightarrow CC3 \rightarrow CC4 \rightarrow TT1 \rightarrow TT2 \rightarrow TT3 \rightarrow TT4
 \uparrow \leftarrow CS6 \leftarrow CS5 \leftarrow CS4 \leftarrow CS3 \leftarrow CS2 \leftarrow CS1 \downarrow

NOTE

- Caption Display will not work when viewing a 480i, 480p, 720p, 1080i or 1080p input via the COMPONENT: Y-PbPr or HDMI inputs.
- Closed Captions availability and content depends on the broadcaster. Closed Caption are available when the Closed Caption icon is displayed on screen.
- Closed Captions and Digital Captions availability and content depends on the broadcaster. Closed Caption are available when the Closed Caption icon is displayed on screen.

Direct Button Operation

VIEW MODE

You can select the screen size.

1 Press **VIEW MODE**.



- The View Mode menu displays.
- The menu lists the View Mode options selectable for the type of video signal currently being received.

2 Press **VIEW MODE** or **▲/▼** while the View Mode menu is displayed to select a desired item on the menu.

- You can sequentially select a View Mode that has its own aspect ratio.

■ For 4:3 programs

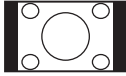
Example: Screen size images

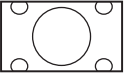
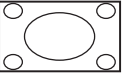
Normal	S.Stretch (Smart stretch)	Zoom	Stretch
 <p>Suitable for viewing conventional 4:3 programs in their normal format.</p>	 <p>Suitable for stretching 4:3 programs to fill the screen.</p>	 <p>Suitable for viewing wide-screen 2.35:1 anamorphic DVDs in full screen.</p>	 <p>This mode is useful for 1.78:1 DVDs. When viewing 1.85:1 DVDs, stretch mode will still show very thin black bands at the top and bottom of the screen.</p>

■ For HD programs

Stretch: Suitable for viewing wide-screen 1.78:1 aspect ratio program, stretch mode will still show very thin black bands at the top and bottom of the screen.

Dot by Dot (1080i/p only): Detects the resolution of the signal and displays an image with the same number of pixels on the screen.

Full Screen(720p only): You can select "Full Screen" only when receiving a 720p signal.

S.Stretch (Smart stretch): Suitable for stretching 4:3 programs to fill the screen.

Zoom: Suitable for viewing wide-screen 2.35:1 aspect-ratio programs in full screen.

NOTE



- When using Dot by Dot or Full Screen, it is possible to see noise or bars around different outer portions of the screen, Please change view mode to correct this.

■ For PC input mode

NOTE

- Connect the PC before making adjustments.
- Selectable screen size may vary with input signal type.

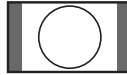
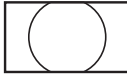
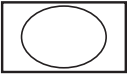
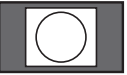
Example: Screen size images

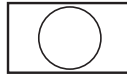
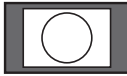
<p>Input signal</p>  <p>4:3</p>	<p>Normal</p>  <p>Keeps the original aspect ratio in a full screen display.</p>	<p>Cinema</p>  <p>For viewing widescreen programs. The top and bottom of the image is cropped.</p>	<p>Full Screen</p>  <p>An image fully fills the screen.</p>	<p>Dot by Dot</p>  <p>Detects the resolution of the signal and displays an image with the same number of pixels on the screen.</p>
<p>Input signal</p>  <p>16:9</p>	<p>Normal</p>  <p>An image fully fills the screen.</p>	<p>Dot by Dot</p>  <p>Detects the resolution of the signal and displays an image with the same number of pixels on the screen.</p>		

On-Screen Display Menu

Menu Items

For TV Mode

Picture Settings	28	Initial Setup	33
AV MODE (Changing Pic.Quality)	29	EZ Setup	33
OPC	29	Broadcasting Setup	34
Backlight	28	CH Setup	34
Contrast	28	Favorite CH (Favorite Channel Setting)	34
Brightness	28	Language	34
Color	28	Individual Setup	34
Tint	28	Secret No.	34
Sharpness	28	Parental CTRL (Parental Control Setting)	34
Advanced	29	V-Chip	35
Color Temp. (Color Temperature)	29	V-Chip(DTV Only)	34
Active Contrast	29	Status	34
DI Film Mode	29	Reset	34
Digital Noise Reduction	29	Information	36
Audio Settings	30	Identification	36
Treble	30	Connecting a USB Memory Device/ USB Hard Drive	37
Bass	30	Select the Files to Play Back	37
Balance	30	Playing Back Files on a USB Memory Device ...	37
Surround	30	Photo Mode	37
Power Control	30	Viewing Thumbnails	37
No Signal Off	30	Viewing Individual Photos	38
Power Saving	30	Slide Show	38
System Options	31	Music Mode	38
View Option	31	Video Mode	39
View Mode	31	USB Device Compatibility	39
Freeze	31		
Change Audio	31		
MTS	31		
Audio Language	31		
Change CC	31		
Analog Closed Caption	32		
Digital Closed Caption	32		
Input Terminal Setting	32		
Audio Setup	32		
PC Input	32		
Auto Sync. (for Analog PC Input Mode Only)	32		
Fine Sync.	32		
Audio Select	32		
HDMI Setup	33		
Speaker	33		
Caption Setup	33		

NOTE

- Some menu items may not be displayed depending on the selected input source.

On-Screen Display Menu

Menu Operation Button

Using the remote control

Use the following buttons on the remote control to operate the menu.

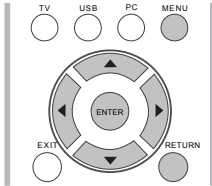

MENU : Press to open or close the menu screen.

▼/▲/◀/▶: Press to select a desired item on the screen or adjust a selected item.

ENTER: Press to go to the next step or complete the setting.

RETURN: Press to return to the previous step.

Using the control panel of the main unit

You can also operate the menu with the control panel of the main unit.

Button operations on the control panel correspond to the ones on the remote control as shown below.



CH ▲/▼: Cursor ▲/▼ on the remote control.

VOL +/−: Cursor ◀/▶ on the remote control.

MENU: **MENU** on the remote control or **EXIT** on the remote control while OSD menu is on.

INPUT: **ENTER** on the remote control.

Picture Settings

Adjusts the picture to your preference with the following picture settings.

Example

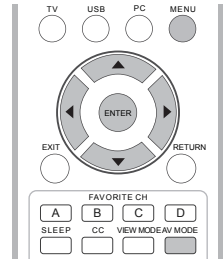
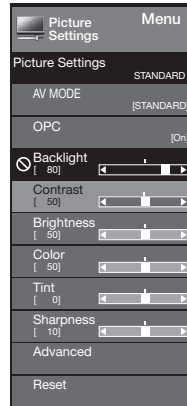

1. Press **MENU** to display the MENU screen, and then press ◀/▶ to select "Picture Settings" and press **ENTER** or ▼ to enter it.
2. Press ▲/▼ to select a specific adjustment item and press **ENTER** or ▶ to enter the setting.
3. Press ◀/▶ to adjust the setting.
4. Press **MENU** to exit.

Selected item	◀ button	▶ button
Backlight	The screen dims	The screen brightens
Contrast	For less contrast	For more contrast
Brightness	For less brightness	For more brightness
Color	For less color intensity	For more color intensity
Tint	Skin tones become reddish	Skin tones become greenish
Sharpness	For less sharpness	For more sharpness

NOTE

- Backlight control is disabled when OPC is "On".

On-Screen Display Menu

AV MODE (Changing Pic.Quality)

The audio and video settings can be changed to suit the program or input content being watched.

Select from the following AV modes.
USER/STANDARD/MOVIE/GAME/PC/
DYNAMIC/DYNAMIC (Fixed)

NOTE

- You can select AV MODE by pressing **AV MODE** on the remote control unit. See page 24 for details of AV MODE settings.

OPC

Automatically adjusts the brightness of the screen.

Off: The brightness is fixed at the value set in "Backlight".

On: Automatically adjusts.

NOTE

- When set to "On", the Optical Picture Control (OPC) senses the surrounding light and automatically adjusts the backlight brightness. Make sure nothing obstructs the OPC sensor, which could affect its ability to sense surrounding light.

Advanced

This TV provides various advanced functions for optimizing the picture quality.

NOTE

- For resetting all adjustment items to the factory preset values, press ▲/▼ to select "Reset", and then press **ENTER**.

Color Temp. (Color Temperature)

For a better white balance, use color temperature correction.

Warm: White with reddish tone

Standard: 

Cool: White with bluish tone

User:

White balance can be adjusted manually through the R/G/B Gain between a maximum of 255 and a minimum of 0 for each color temperature.

NOTE

- For resetting all adjustment items to the factory preset values, press ▲/▼ to select "Reset", and then press **ENTER**.

Active Contrast

Automatically adjusts the image contrast according to the scene.

On: Automatically adjusts the image contrast.

Off: No adjustment.

DI Film Mode

Automatically detects a film-based source (originally encoded at 24 frames/second), analyzes it then recreates each still film frame for high-definition picture quality.

Auto: Detects, analyzes, converts film source.

Off: Normal viewing mode.

NOTE

- "DI Film Mode" does not function depending on input signal type.
- "Auto" does not function when channel display shows an input signal resolution of 480p, 720p, or 1080p.
- "DI Film Mode" is not available during PC format input.

Digital Noise Reduction

Produces a clearer video image.

Auto: Automatically adjusts the level of noise reduction.

High/Middle/Low: Select a desired level for viewing a clearer video image.

Off: No adjustment.

NOTE

- "Digital Noise Reduction" is not available when you set PC format is being input.

On-Screen Display Menu

Audio Settings

You can adjust the sound quality to your preference with the following settings.

Example

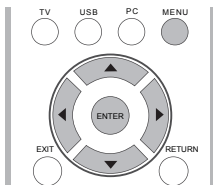
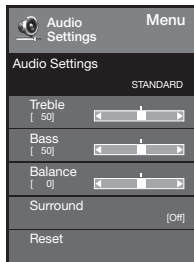

1. Press **MENU** to display the MENU screen, and then press ◀/▶ to select "Audio Settings".
2. Press ▲/▼ to select a specific adjustment item.
 - Select "Surround" and then press ◀/▶ to set.
3. Press ▲/▼ (or ◀/▶) to select the desired setting, and then press **ENTER**.
4. Press **MENU** to exit.

Selected item	◀ button	▶ button
Treble	For weaker treble	For stronger treble
Bass	For weaker bass	For stronger bass
Balance	Decrease audio from the right speaker	Decrease audio from the left speaker

NOTE

- For resetting Audio adjustment items to the factory preset values, press ▲/▼ to select "Reset", press **ENTER**, press ▲/▼ to select "Yes", and then press **ENTER**.

Surround

The surround function produces Surround effect from the speakers.

On: Makes it possible to enjoy natural, realistic surround sound.

Off: Outputs the normal sound.

NOTE

- For some discs, setup may be required on your DVD/BD player. In this case, please refer to the operation manual of your DVD/BD player.

Power Control

Power control setting allows you to save energy.

Example

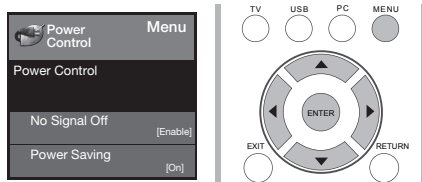

1. Press **MENU** to display the MENU screen, and then press ◀/▶ to select "Power Control".
2. Press ▲/▼ to select a specific adjustment item, and then press **ENTER**.
3. Press ▲/▼ (or ◀/▶) to select the desired setting, and then press **ENTER**.
4. Press **MENU** to exit.

No Signal Off

This function allows the TV to automatically shut the power down when there is no signal received.

Enable: The power will automatically shut down if there is no signal for 15 minutes.

Disable: This function does not work.

Power Saving

This function allows you to set the Power Saving level in order to decrease the power consumption and increase the backlight lifespan.

On: Optimizes power reduction based upon video content.

Off: This function does not work.

NOTE

- "Power Saving" does not function when you set AV MODE to DYNAMIC (Fixed)".
- You cannot select a different Power Saving item for each AV MODE.

On-Screen Display Menu

System Options

Example

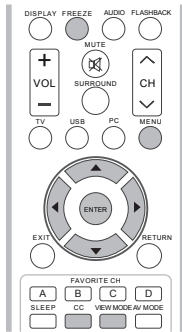
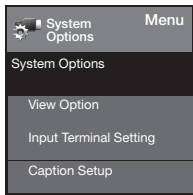

1. Press **MENU** to display the MENU screen, and then press **◀/▶** to select "System Options".
2. Press **▲/▼** to select a specific adjustment item and then press **ENTER**.
3. Press **▲/▼** (or **◀/▶**) to select the desired setting, and then press **ENTER**.
4. Press **MENU** to exit.

View Option

These functions are useful for adjusting the audio and video settings. The View Option functions can be operated with the remote control unit.

View Mode

This function changes the screen size. Select "View Option" on the menu to display the View Mode menu screen. The View Mode menu varies depending on the input source.

NOTE

- You can select View Mode by pressing **VIEW MODE** on the remote control unit.
— See page 25 for adjusting the video being input from a TV, PC, other audiovisual equipment, USB-Video.

Freeze

Allows you to capture and freeze a moving image that you are watching.

NOTE

- You can select Freeze by pressing **FREEZE** on the remote control unit. See page 23 for details of Freeze function.

Change Audio

MTS

The TV has a feature that allows reception of sound other than the main audio for the program. This feature is called Multi-channel Television Sound (MTS). The TV with MTS can receive mono sound, stereo sound and Secondary Audio Programs (SAP). The SAP feature allows a TV station to broadcast other information, which could be audio in another language or something completely different like weather information.

You can enjoy Hi-Fi stereo sound or SAP broadcasts where available.

- **Stereo broadcasts:** View programs like live sporting events, shows and concerts in dynamic stereo sound.
- **SAP broadcasts:** Receive TV broadcasts in either MAIN or SAP sound.
MAIN sound: The normal program soundtrack (either in mono or stereo).
SAP sound: Listen to a second language, supplementary commentary or other information. (SAP is mono sound.)

If stereo sound is difficult to hear.

- Obtain a clearer sound by manually switching to fixed mono-sound mode.

You can change MTS as shown below to match the television broadcast signal.

Press **ENTER** to toggle between audio modes.

Examples: when receiving MTS and SAP

STEREO mode: STEREO ↔ MONO
STEREO + SAP mode: ST(SAP) → SAP(ST) → MONO

MAIN + SAP mode: MAIN ↔ SAP

MONO mode: MONO

Digital broadcasting audio mode

The types of audio transmitted in a digital broadcast include SURROUND as well as MONO and STEREO. In addition, it is possible for multiple audio tracks to accompany a single video track.

Press **ENTER** to toggle between audio modes.

Example: when receiving Digital broadcasting

STEREO (Audio 1) → STEREO (Audio 2)
SURROUND (Audio 3)

NOTE

- MTS only operates while in TV mode.

Audio Language

Gives you the possibility to swap between main and alternative language, when it is available in digital channel.

Change CC

Allows you to change the Closed Caption display. Select "Change CC" on the menu to display the Closed Caption information.

NOTE

- You can change Closed Caption by pressing **CC** on the remote control unit. See page 24 for details of Closed Caption function.

On-Screen Display Menu

Analog Closed Caption

This allows you to select the Closed Captions service levels of analog broadcasting to be displayed. Closed captioning allows you to read the voice content of television programs on the TV screen. Designed to help the hearing impaired, this feature uses on-screen "text boxes" to show dialogues and conversations while the TV program is in progress. Captions will appear on the screen during captioned broadcasts.

- **CC1, 2, 3, or 4**

Dialogues (and descriptions) for the action on the captioned TV program shows on screen. Usually CC1 is the most used. CC2 can be used for alternate languages if they are being transmitted.

- **TEXT1, 2, 3, or 4**

Often used for channel guide, schedules, bulletin board information for Closed captions programs, news, weather information, or stock market reports. Not all Caption services are necessarily being used by a TV channel during the transmission of a Closed Caption program.

Digital Closed Caption

This allows you to configure the way you choose to view digital captioning. Select one of the digital service channels made available by the caption provider. There are six standard services. Service 1 is designated as the Primary Caption Service. This service contains the verbatim, or near-verbatim captions for the primary language being spoken in the accompanying program audio. Service 2 is designated as the Secondary Language Service. This service contains captions in a secondary language, which is a translation of the captions in the primary Caption Service. The other service sub channels are not pre-assigned. It is up to the discretion of the individual caption provider to utilize the remaining service channels.

Input Terminal Setting

Audio Setup

You can output digital audio to an AV amplifier or similar device whose DIGITAL AUDIO INPUT terminal is connected to the DIGITAL AUDIO OUTPUT terminal on the TV. Please select an audio output format compatible with the audio format of the program you are watching and the equipment connected.

PCM: The optical output terminal outputs audio signal in PCM form. If your digital audio system does not support Dolby Digital, select "PCM".

Dolby Digital: The optical output terminal outputs audio signal in Dolby Digital form. It reproduces sound from surround program of digital.

Off: Disables digital audio output.

PC Input

Auto Sync. (for Analog PC Input Mode Only)

For automatically adjusting the PC image. The Auto Sync is only available when the input source is PC and your TV is receiving a computer signal. Select **Auto Sync.** for adjusting the settings automatically.

NOTE

- Be sure to connect the PC to the TV and switch it on before starting "Auto Sync."

Fine Sync.

Ordinarily you can easily adjust the picture as necessary to change image position using "Auto Sync.". In some cases, however, manual adjustment is needed to optimize the image.

H-Pos.: Centers the image by moving it to the left or right.

V-Pos.: Centers the image by moving it up or down.

Clock: Adjust when the image flickers with vertical stripes.

Phase: Adjust when characters have low contrast or when the image flickers.

NOTE

- The default cursor position may not be in the center, because the screen position variable ranges may be asymmetrical.
- The screen position variable ranges depend on the View Mode or the signal type. The ranges can be seen on the position-setting screen.

Audio Select

This function sets the terminal to output the computer audio.

The adjustment items vary depending on the input source. Select the input source corresponding to the terminal connected to the PC and then adjust the desired item.

On-Screen Display Menu

■ PC IN

Video: Select this when the TV and PC are connected using an analog RGB cable and the audio is not input.

Video+Audio: Select this when the TV and PC are connected using an analog RGB cable and the audio is input via a Ø 3.5 mm stereo minijack.

■ HDMI IN

Auto: Audio path is set to HDMI or PC line in automatically.

HDMI(Digital): Select this when the TV and PC are connected using an HDMI-certified cable and audio is input via the same cable.

HDMI+Analog: Select this when the TV and PC are connected using a DVI-HDMI conversion cable and the audio is input via a Ø 3.5 mm stereo minijack.

NOTE

- When "Audio Select" is set to "HDMI(Digital)", sound will not be produced if you use only an HDMI-certified cable to connect HDMI-compatible equipment. To produce sound, you should make an analog audio connection.
- If you want to connect HDMI-compatible equipment using only an HDMI-certified cable, set "Audio Select" to "HDMI(Digital)".

HDMI Setup

HDMI Mode only shows and is available when HDMI device is connected. Select from **Auto**, **Graphic** or **Video**.

Auto: The HDMI input timing is set to Video mode or Graphic mode automatically.

Graphic: HDMI input timing set to Graphic mode (PC). The image is full scan.

Video: HDMI input timing set to Video mode. The image is over scan.

NOTE

- HDMI Mode is only workable for HDMI Video & Progressive timing as followed: 1920x1080p, 1280x720p, 720x480p, 720x576p.

Speaker

Choose to turn on or off the TV internal speaker. The audio output signals will not be turned off even though the TV speaker is off. The default setting is On.

Caption Setup

This function allows you to adjust the closed caption screen appearance to suit your preference. You can adjust 8 items:

- Caption Style:** Set to As Default or Custom mode. If Custom mode is selected, user can modify the detail styles described below. The setting result will be shown immediately on the bottom of the submenu OSD.
Note: This feature is only available in Digital TV (ATSC) mode.
- Caption Size:** Selects this option to choose a caption display size according to your own preference. Select "Small", "standard", or "Large".
- Foreground Color:** Choose the caption display text color.
- Foreground Opacity:** Select the text opacity.
- Background Color:** Choose one of the background color.
- Background Opacity:** Choose one of the background opacity options.
- Window Color:** Choose one of the display windows color.
- Window Opacity:** Select one of the display window opacity options.

Initial Setup

Example

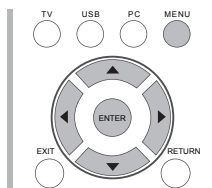
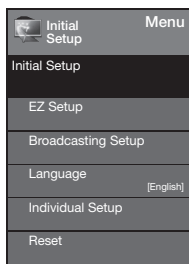

- Press **MENU** to display the MENU screen, and then press **◀/▶** to select "Initial Setup".
- Press **▲/▼** to select a specific adjustment item, and then press **ENTER**.
 - When you select Individual Setup, you can enter the 4-digit secret number here. See page 34 for setting a secret number.
- Press **▲/▼** (or **◀/▶**) to select the desired setting, and then press **ENTER**.
- Press **MENU** to exit.

EZ Setup

You can run EZ Setup again, even after setting up the preset channels.

Language: Select from among 3 languages (English, French and Spanish).

TV Location: Select "Home" or "Store" for the location where you plan to install the TV.

Home: "Power Saving" is set to "On", and AV MODE is set to "STANDARD".

Store: "Power Saving" is set to "Off" and AV MODE is set to "DYNAMIC (Fixed)". Picture Reset and Feature Demo can be set.

On-Screen Display Menu

Air/Cable: Make sure what kind of connection is made with your TV when selecting "Air" or "Cable".

CH Search: Channel auto search makes the TV look for all channels viewable in the set area.

- If "Cable" is selected for Antenna setting, scrambled channels are removed after the Channel search has been completed.

Completed: The settings confirmation screen is displayed. Confirm the information displayed on the screen.

NOTE

- See EZ Setup on pages 21 to 22 for setting each item.
- If no channel is found, confirm the type of connection made with your TV and try "EZ Setup" again.

Broadcasting Setup

CH Setup

If Initial Installation does not memorize all the channels in your region, follow the instructions below to manually memorize the channels.

Air/Cable: Make sure what kind of connection is made with your TV when selecting "Air" or "Cable".

CH Search: Channel auto search makes the TV look for all channels viewable in the set area.

CH Memory: You can select the channels to skip in each ANALOG (Air), ANALOG (Cable), DIGITAL (Air) and DIGITAL (Cable).

NOTE

- If no channel is found, confirm the type of connection made with your TV and try channel search again.
- If you press **ENTER** after CH search finish, CH search is re-start.

Favorite CH (Favorite Channel Setting)

This function allows you to program 4 favorite channels, in 4 different categories. By setting the favorite channels in advance, you can select your favorite channels easily.

To register your favorite channel:

1. Press **MENU** on the remote control and select "Initial Setup"/"Broadcasting Setup"/"Favorite CH".
2. Press **▲/▼** to select the category that you want to store your favorite channel.
3. Press **▲/▼** to select your desired channel and press **ENTER** button to confirm.

To delete your favorite channel

1. Press **MENU** on the remote control and select "Initial Setup"/"Broadcasting Setup"/"Favorite CH".
2. Press **▲/▼** to select "All data clear" and press **ENTER** to start clearing all favorite channel data.

NOTE

- While watching, you can toggle the selected channels by pressing the **A, B, C,** and **D** button on the remote control.

Language

You can also select a language from the Initial Setup menu. Select from among 3 languages: English, French and Spanish.

Reset

If complex adjustments are made and the settings cannot be restored to normal, you can reset the settings to the factory preset values.

NOTE

- The Channel Setup settings will not be changed.
- The Language settings will not be changed.
- The Secret number settings will not be changed.
- The TV Location settings will not be changed.

Individual Setup

Before entering the Individual Setup, user has to key in the Secret No. first. Enter a 4-digit Secret No. with the number buttons on the remote control. The default Secret No. is 0000.

Secret No.

Allows you to use a secret number to protect certain settings from being accidentally changed.

New Secret No. :

Enter a 4-digit Secret No. with the number buttons on the remote control to change your secret No. .

Confirm Secret No. :

Enter your new 4-digit Secret No. again to confirm.

NOTE

- As a precautionary measure, make a note of your secret number and keep it in a familiar place.

Parental CTRL (Parental Control Setting)

Status

Used to enable or disable the parental control function. This function will not be selectable from the menu if you do not first configure your secret number.

Yes: Enables Parental CTRL.

No: Disables Parental CTRL.

V-Chip(DTV Only)

The "V-Chip (DTV Only)" will only be selectable when a new rating system can be downloaded via digital broadcasting in the U.S.

On-Screen Display Menu

V-Chip

V-CHIP is an electronic filtering device built into your TV. This tool gives parents a great degree of control over broadcasts accessed by their children. It allows parents to select programs judged suitable for child viewing while blocking ones judged not suitable. It does so automatically once you activate the V-CHIP feature in your TV. "V-Chip" and "Status" will not be selectable from the menu if you do not first configure your secret number.

- The U.S. has two rating systems for viewing content: TV Parental Guidelines and movie ratings.
- The TV Parental Guidelines work in conjunction with the V-CHIP to help parents screen out inappropriate television shows from their children.
- Movie ratings are used for original movies rated by the Motion Picture Association of America (MPAA) as watched on cable TV and not edited for television. The V-CHIP can also be set to block MPAA-rated movies.

NOTE

- The setting automatically enters "Block" for any ratings below your selection.
- If Status is not set to "On", the configuration settings will not work.

MPAA (Voluntary movie rating system)

Example

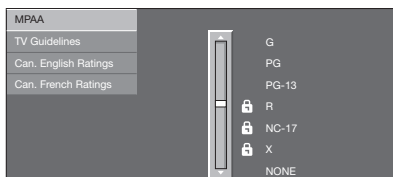

Press ▲/▼ to adjust the item to your desired position. "🔒" indicates the item is blocked.

Press **MENU** to exit.

G: General audiences. All ages admitted.

PG: Parental guidance suggested. Some material may not be suitable for children.

PG-13: Parents strongly cautioned. Some material may be inappropriate for children under 13.

R: Restricted. Under 17 requires accompanying parent or adult guardian (age varies in some jurisdictions).

NC-17: No one 17 and under admitted.

X: X is an older rating that is unified with NC-17 but may be encoded in the data of older movies.

NOTE

- Voluntary movie rating system only uses an age-based rating.

TV Parental Guidelines

Example

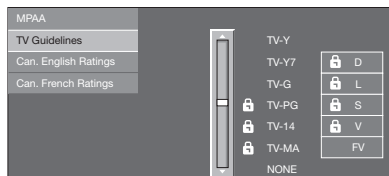

Press ▲/▼ to adjust the item to your desired position. "🔒" indicates the item is blocked.

Press **MENU** to exit.

Suggested age

TV-Y: All children.

TV-Y7: Directed to older children.

TV-G: General audience.

TV-PG: Parental Guidance suggested.

TV-14: Parents strongly cautioned.

TV-MA: Mature audience only.

Example

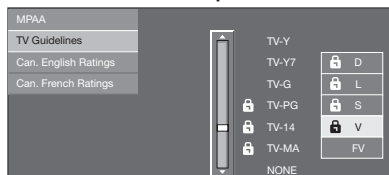

When setting an individual content-based rating item:

1. Press ► or **ENTER** to access blocked content items from the currently selected age-based rating item.
2. Press ▲/▼ to select an individual item, and then press **ENTER** to unblock it ("🔒" is removed). Repeat the same steps for the other items.
3. Press ◀ or **RETURN** to register after all individual content rating items are set.

Content

FV: Fantasy violence.

V: Violence.

S: Sexual situation.

L: Adult language.

D: Sexually suggestive dialog.

Rating	Content					
	FV	V	S	L	D	
Suggested age	TV-Y	☑	☑	☑	☑	☑
	TV-Y7	×	☑	☑	☑	☑
	TV-G		☑	☑	☑	☑
	TV-PG		×	×	×	×
	TV-14		×	×	×	×
	TV-MA		×	×	×	

On-Screen Display Menu

☒: The content rating can be set, but this rating is not normally broadcast by TV stations.

✕: Content rating can be set.

Canadian Rating Systems (Canadian English ratings and Canadian French ratings)

- The TV rating systems in Canada are based on the Canadian Radio-Television and Telecommunications Commission (CRTC) policy on violence in television programming.
- While violence is the most important content element to be rated, the structure developed takes into consideration other program content like language, nudity, sexuality and mature themes.
- When setting the V-CHIP on the Canadian system you can choose either the Canadian English ratings or the Canadian French ratings.

Canadian English Ratings

Example

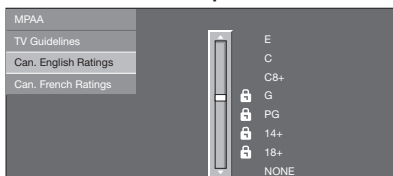

Press ▲/▼ to adjust the item to your desired position. "🔒" indicates the item is blocked.

Press **MENU** to exit.

E: Exempt: Includes news, sports, documentaries and other information programming; talk shows, music videos, and variety programming.

C: Children: Intended for younger children under the age of 8 years. Pays careful attention to themes that could threaten their sense of security and well-being.

C8+: Children over 8 years old: Contains no portrayal of violence as the preferred, acceptable, or only way to resolve conflict; nor encourage children to imitate dangerous acts which they may see on the screen.

G: General: Considered acceptable for all age groups. Appropriate viewing for the entire family, contains very little violence, physical, verbal or emotional.

PG: Parental Guidance: Intended for a general audience, but may not be suitable for younger children (under the age of 8) because it could contain controversial themes or issues.

14+: Over 14 years: Could contain themes where violence is one of the dominant elements of the storyline, but it must be integral to the development of plot or character. Language usage could be profane and nudity present within the context of the theme.

18+: Adults: Intended for viewers 18 years and older and might contain depictions of violence, which while related to the development of plot, character or themes, are intended for adult viewing. Could contain graphic language and portrayals of sex and nudity.

Canadian French Ratings

Example

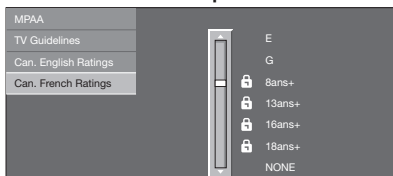

Press ▲/▼ to adjust the item to your desired position. "🔒" indicates the item is blocked. Press **MENU** to exit.

E: Exempt programming.

G: General: All ages and children, contains minimal direct violence, but may be integrated into the plot in a humorous or unrealistic manner.

8ans+: General but inadvisable for young children: May be viewed by a wide public audience, but could contain scenes disturbing to children under 8 who cannot distinguish between imaginary and real situations. Recommended for viewing with parent.

13ans+: Over 13 years: Could contain scenes of frequent violent scenes and therefore recommended for viewing with parent.

16ans+: Over 16 years: Could contain frequent violent scenes and intense violence.

18ans+: Over 18 years: Only for adult viewing. Could contain frequent violent scenes and extreme violence.

How to temporarily release the V-CHIP BLOCK

When the V-CHIP BLOCK is working and censors a broadcast, "V-CHIP HAS BEEN ACTIVATED." displays.

1. Press **ENTER** while the V-CHIP is working, and then the secret number setting menu displays.
2. Input the 4-digit secret number by using **0-9**.
At this time V-CHIP BLOCK temporarily releases.

Reactivating the temporarily released V-CHIP BLOCK

You can reactivate the temporarily released V-CHIP BLOCK as shown below.

- Select "Status" setting from the Parental CTRL menu to reactivate BLOCK. (See page 34.)
- Select "V-Chip" setting ("MPAA", "TV Guidelines", "Can. English Ratings" or "Can. French Ratings") from the Parental CTRL to reactivate BLOCK. (See pages 35 to 36.)
- Switch off the TV power.

NOTE

- Performing any of the three above will activate the V-CHIP BLOCK.

Information

Example

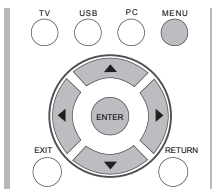
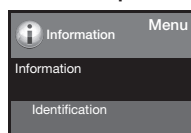

1. Press **MENU** to display the MENU screen, and then press ◀/▶ to select "Information".
2. Press ▲/▼ to select a specific adjustment item, and then press **ENTER**.
3. Press ▲/▼ (or ◀/▶) to select the desired setting, and then press **ENTER**.
4. Press **MENU** to exit.

Identification

The current version of the TV software is displayed.

Enjoying Photo/Music/Video Playback

You can connect the TV to a USB memory device, USB hard drive to enjoy viewing pictures, listening to music, and watching videos.

NOTE

- Depending on the USB memory device/USB hard drive, the TV may not be able to recognize the recorded data.
- It may take time to read the recorded data if the USB memory device/USB hard drive contains many files or folders.
- Use only alphanumeric characters for naming files.
- File names over 80 characters (may vary depending on character set) may not be displayed.

Connecting a USB Memory Device/USB Hard Drive

Insert the USB memory device with recorded photos, music or videos into the USB terminal on the TV.

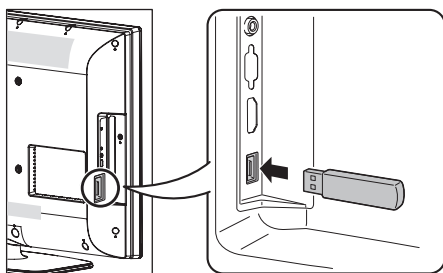

- When connecting a USB hard drive, be sure to use a hard drive with an AC adapter.
- Do not remove a USB memory device or memory card from the TV while transferring files, using the slide show function, or switching screens, or before you exit "USB" from the INPUT list.
- Do not insert and remove a USB memory device/USB hard drive to and from the TV repeatedly.
- When using a card reader, be sure to insert Memory first before using the card reader.

CAUTION

- Do not use a USB extension cable when connecting a USB memory device to the USB terminal on the TV.**
- Using a USB extension cable with the USB memory device may prevent the TV from performing correctly.**

Select the Files to Play Back

- Press **INPUT** to select USB from the input list or press **USB** direct button to enter it.

Input Source	
TV	
INPUT1	HDMI1
INPUT2	HDMI2
INPUT3	HDMI3
INPUT4	COMP/AV
PC IN	
▼	USB

- Press **◀/▶** to select "Photo", "Music" or "Video", and then press **ENTER**.

Example

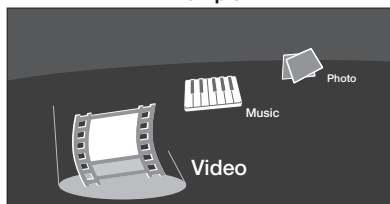

- Press **◀/▶** to select the desired folder, and then press **ENTER**.

NOTE

- 16GB is the maximum number of USB drives that can be displayed.
- "VIEW MODE" is fixed during the Photo or Music mode. During "Video mode", is depending on the type of video signal currently being received.(see page 25)
- The key guide display disappears automatically after a set time. To display the key guide display again, press **DISPLAY**.

Playing Back Files on a USB Memory Device

Photo Mode

Viewing Thumbnails

Example



Buttons for thumbnails operations

Buttons	Description
▲/▼/◀/▶	Select a desired item.
ENTER	When selecting a folder icon: Enter this directory. When selecting a photo thumbnail: Slide show.
EXIT	Return to the previous process.
Menu	Sub Menu

Enjoying Photo/Music/Video Playback

Press **MENU** to display the sub-menu. You can browse the files by the following options.

- Sort
- Media Type
- Thumbnail size

NOTE

- When there are invalid photo files, the X mark will be display for the file.
- You can see the file name, shooting date, file size and pixel size of the selected photo in the top-left corner of the screen (shooting date is only available in the EXIF file format).

Slide Show

The photo selected on the thumbnail selection screen by press **ENTER**.

Example

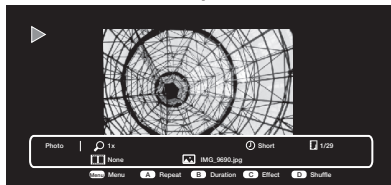

Buttons for slide show operation

Buttons	Description
EXIT	Return to the thumbnail selection screen.
A (red)	Repeat one / Repeat all.
B (green)	Select slider show interval.
C (blue)	Select slide show effect.
D (yellow)	Play the photo in random order.
◀◀ / ▶▶	Go to the previous/next photo.
	Viewing individual photo.
DISPLAY	Display the information.
Menu	Sub Menu.

Press **MENU** to display the sub-menu. You can select the following options to display the photos.

- Pause
- Repeat
- Shuffle
- Duration
- Effect
- Show Info

NOTE

- The key guide display disappears automatically after a set time. To display the key guide display again, press **DISPLAY**.

Viewing Individual Photos

The photo in slide show by pressing **||**.

Example



Buttons for viewing Individual Photos operation

Buttons	Description
EXIT	Return to the thumbnail selection screen.
A (red)	Repeat one / Repeat all
B (green)	Rotate the photo by 90 degrees to the right.
C (blue)	Zoom photo.
D (yellow)	Play the photo in random order.
◀◀ / ▶▶	Go to the previous/next photo.
▶	Slider show.
DISPLAY	Display the information.
Menu	Sub Menu

Press **MENU** to display the sub-menu. You can select the following options to display the photos.

- Play
- Repeat
- Shuffle
- Rotate
- Zoom
- Show Info

NOTE

- The key guide display disappears automatically after a set time. To display the key guide display again, press **DISPLAY**.
- Rotating photos only applies to the temporarily selected item and this setting is not saved.

Music Mode

Example



Buttons for music mode

Buttons	Description
▲/▼/◀/▶	Select a desired item.
ENTER	When selecting a folder icon: Enter this directory. When selecting a music file: Play music.
EXIT	Return to the previous process.
Menu	Sub Menu

Press **MENU** to display the sub-menu. You can browse the files by the following options.

- Sort
- Media Type
- Thumbnail size

Example



Enjoying Photo/Music/Video Playback

Buttons for playing music

Buttons	Description
EXIT	Return to the thumbnail selection screen.
A(red)	Repeat one / Repeat all
B(green)	Play the music in random order.
◀ / ▶	Go to the next/previous photo.
◀◀ / ▶▶	Forward/Backward.
▶ / 	Play/Pause.
DISPLAY	Display the information.
Menu	Sub Menu

Press **MENU** to display the sub-menu. You can select the following options to play the musics.

- Pause
- Repeat
- Shuffle On
- Show Info
- Hide Spectrum
- Lyric options

Video Mode

Example

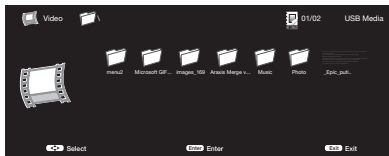

Buttons for Video mode

Buttons	Description
▲/▼/◀/▶	Select a desired item.
ENTER	When selecting a folder icon: Enter this directory. When selecting a video file: Play video.
EXIT	Return to the previous process.
Menu	Sub Menu

Press **MENU** to display the sub-menu. You can browse the files by the following options.

- Sort
- Media Type
- Thumbnail size

Example

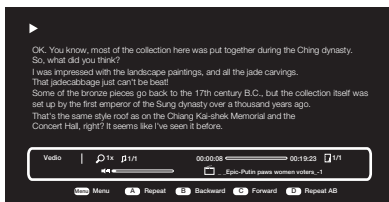

Buttons for playing Video

Buttons	Description
EXIT	Return to the thumbnail selection screen.
A(red)	Repeat one / Repeat all
B(green)	Backward
C (blue)	Forward
D (yellow)	Repeat AB. Select the part you want to play repeatedly.
◀◀ / ▶▶	Go to the next/previous video.
▶ / / ■	Play/Pause/Stop.
DISPLAY	Display the information.
Menu	Sub Menu

Press **MENU** to display the sub-menu. You can follow the options to play the videos.

- Pause
- Repeat
- Program
- Show Info
- AV Mode
- Title
- Edition
- Chapter
- View Mode

USB Device Compatibility

USB device	USB Memory, USB card reader (Mass Storage class), USB hard drive
File system	FAT/FAT32/NTFS (USB hard drive only)
Photo file format	JPEG (.jpg .jpeg) Progressive JPEG (.jpg .jpeg) BMP (.bmp) PNG (.png)
Music file format	MP3 (.mp3) Bitrate: 32k, 40k, 48k, 56k, 64k, 80k, 96k, 112k, 128k, 160k, 192k, 224k, 256k, 320kbps Sampling frequency: 32k, 44.1k, 48kHz

Video file format

File extension	Container	Video	Audio
.avi	AVI	XviD H.264 MPEG4 Motion Jpeg MPEG2 MPEG1	MP3 AC3 LPCM ADPCM
.mkv	MKV	XviD H.264 MPEG4 MPEG2	MP3 AC3 LPCM ADPCM
.asf	ASF	XviD H.264	MP3 AC3 LPCM ADPCM
.mp4	MP4 (SMP4)	XviD H.264 MPEG4	MP3 AAC/HEAAC
.mov	MP4 (SMP4)	XviD H.264 MPEG4 Motion Jpeg	MP3 AAC/HEAAC
.mpg .mpeg	PS	MPEG2 MPEG1	AC3 LPCM MPEG

NOTE

- Operation using USB hubs is not guaranteed.
- Some video file formats may not be played depending on the file.
- Some images may not be displayed in the appropriate aspect ratio depending on the file format.

Appendix

Troubleshooting

Problem	Possible Solution
<ul style="list-style-type: none"> No power 	<ul style="list-style-type: none"> Check if you pressed POWER on the remote control unit. (See page 21.) If the indicator on the TV is still red, press POWER on the TV. Is the AC cord disconnected? (See page 9.) Has the power been turned on? (See page 21.)
<ul style="list-style-type: none"> Unit cannot be operated. 	<ul style="list-style-type: none"> External influences such as lightning, static electricity, may cause improper operation. In this case, operate the unit after first turning off the power of the TV or unplugging the AC cord and re-plugging it after 1 or 2 minutes.
<ul style="list-style-type: none"> Remote control unit does not operate. 	<ul style="list-style-type: none"> Are batteries inserted with polarity (+ , -) aligned? (See page 12.) Are batteries worn out? (Replace with new batteries.) Are you using it under strong or fluorescent lighting? Is a fluorescent light illuminated near the remote control sensor?
<ul style="list-style-type: none"> Picture is cut off/with sidebar screen. 	<ul style="list-style-type: none"> Are screen mode adjustments such as picture size made correctly? (See page 25.)
<ul style="list-style-type: none"> Strange color, light color, or color misalignment 	<ul style="list-style-type: none"> Adjust the picture tone. (See page 29.) Is the room too bright? The picture may look dark in a room that is too bright.
<ul style="list-style-type: none"> Power is suddenly turned off. 	<ul style="list-style-type: none"> Is the sleep timer set? (See page 23.) The unit's internal temperature has increased. Remove any objects blocking vent.
<ul style="list-style-type: none"> No picture 	<ul style="list-style-type: none"> Is connection to other components correct? (See page 16.) Is the correct input selected? (See page 16.)
<ul style="list-style-type: none"> No sound 	<ul style="list-style-type: none"> Is the volume too low? (See page 23.) Have you pressed MUTE on the remote control unit? (See page 23.)
<ul style="list-style-type: none"> The TV sometimes makes a cracking sound. 	<ul style="list-style-type: none"> This is not a malfunction. This happens when the cabinet slightly expands and contracts according to change in temperature. This does not affect the TV's performance.

Cautions regarding use in high and low temperature environments

- When the unit is used in a low temperature space (e.g. room, office), the picture may leave trails or appear slightly delayed. This is not a malfunction, and the unit will recover when the temperature returns to normal.
- Do not leave the unit in a hot or cold location. Also, do not leave the unit in a location exposed to direct sunlight or near a heater, as this may cause the cabinet to deform and the Liquid Crystal panel to malfunction.
Storage temperature: -4°F to +140°F (-20°C to +60°C)

Appendix

Specifications

Item		Model: LC-46SV50U	Model: LC-42SV50U	
LCD panel	Size	46" Class (46" Diagonal)	42" Class (42" Diagonal)	
	Resolution	2,073,600 pixels (1,920 x 1080)	2,073,600 pixels (1,920 x 1080)	
TV Function	TV-standard (CCIR)	American TV Standard ATSC/NTSC System		
	Receiving Channel	VHF/UHF	VHF 2-13ch, UHF 14-69ch	
		CATV	1-135ch (non-scrambled channel only)	
		Digital Terrestrial Broadcast (8VSB)	2-69ch	
		Digital cable ¹⁾ (64/256 QAM)	1-135ch (non-scrambled channel only)	
Audio multiplex	BTSC System			
Audio out		10 W x 2	10 W x 2	
Terminals	Side	INPUT 1	HDMI in with HDCP, Audio in (Ø 3.5 mm stereo jack)	
		USB	Photo/Music/Video mode, Software update	
		Headphone	Headphone out	
		RS-232C	9-pin D-sub male connector	
		DIGITAL AUDIO OUTPUT	Optical Digital audio output x 1 (PCM/Dolby Digital)	
	Rear	INPUT 2	HDMI in with HDCP, Audio in (Ø 3.5 mm stereo jack)	
		INPUT 3	HDMI in with HDCP, Audio in (Ø 3.5 mm stereo jack)	
		INPUT 4	COMPONENT/ AV in	
		INPUT 5	ANALOG RGB (PC) in (15-pin mini D-sub female connector)	
		AUDIO PC/HDMI	Audio in (Ø 3.5 mm jack)	
		ANT/CABLE	75Ω Unbalance, F Type x 1 for Analog And Digital (VHF/ UHF/ CATV)	
	OSD language		English/French/Spanish	
Power Requirement		AC 120V~60Hz		
Power Consumption		210W (0.7W Standby with AC 120V)	170W(0.7W Standby with AC 120V)	
Weight	TV + stand	51.8 lbs./23.5 kg	40.8 lbs./18.5 kg	
	TV only	46.3 lbs./21.0 kg	35.3 lbs./16.0 kg	
Dimension ²⁾ (W x H x D)	TV + stand	44 ⁷ / ₆₄ x 29 ²¹ / ₃₂ x 12 ¹³ / ₃₂ inch	40 ²⁹ / ₃₂ x 27 ²⁷ / ₃₂ x 11 ³ / ₁₆ inch	
	TV only	44 ⁷ / ₆₄ x 27 ⁷ / ₈ x 3 ⁵³ / ₆₄ inch	40 ²⁹ / ₃₂ x 26 ⁷ / ₆₄ x 3 ³³ / ₆₄ inch	
Operating temperature		+32°F to +104°F (0°C to +40°C)		

- As part of policy of continuous improvement, SHARP reserves the right to make design and specification changes for product improvement without prior notice. The performance specification figures indicated are nominal values of production units. There may be some deviations from these values in individual units.

Appendix

Specifications

Item		Model: LC-32SV40U	
LCD panel	Size	32" Class (31 ^{33/64} " Diagonal)	
	Resolution	1,049,088 pixels (1,366 x 768)	
TV Function	TV-standard (CCIR)	American TV Standard ATSC/NTSC System	
	Receiving Channel	VHF/UHF	VHF 2-13ch, UHF 14-69ch
		CATV	1-135ch (non-scrambled channel only)
		Digital Terrestrial Broadcast (8VSB)	2-69ch
	Digital cable ¹ (64/256 QAM)	1-135ch (non-scrambled channel only)	
Audio multiplex	BTSC System		
Audio out		5 W x 2	
Terminals	Side	INPUT 1	HDMI in with HDCP, Audio in (Ø 3.5 mm stereo jack)
		USB	Photo/Music/Video mode, Software update
		Headphone	Headphone out
		RS-232C	9-pin D-sub male connector
		DIGITAL AUDIO OUTPUT	Optical Digital audio output x 1 (PCM/Dolby Digital)
	Rear	INPUT 2	HDMI in with HDCP, Audio in (Ø 3.5 mm stereo jack)
		INPUT 3	HDMI in with HDCP, Audio in (Ø 3.5 mm stereo jack)
		INPUT 4	COMPONENT/ AV in
		INPUT 5	ANALOG RGB (PC) in (15-pin mini D-sub female connector)
		AUDIO PC/HDMI	Audio in (Ø 3.5 mm jack)
ANT/CABLE	75Ω Unbalance, F Type x 1 for Analog And Digital (VHF/ UHF/ CATV)		
OSD language		English/French/Spanish	
Power Requirement		AC 120V-60Hz	
Power Consumption		100W (0.7W Standby with AC 120V)	
Weight	TV + stand	24.3 lbs./11.0 kg	
	TV only	21.2 lbs./9.6 kg	
Dimension ² (W x H x D)	TV + stand	30 ^{63/64} x 22 ^{3/32} x 9 ^{47/64} inch	
	TV only	30 ^{63/64} x 20 ^{9/16} x 3 ^{15/64} inch	
Operating temperature		+32°F to +104°F (0°C to +40°C)	

- As part of policy of continuous improvement, SHARP reserves the right to make design and specification changes for product improvement without prior notice. The performance specification figures indicated are nominal values of production units. There may be some deviations from these values in individual units.

Appendix

PC Compatibility Chart

It is necessary to set the PC correctly to display XGA and WXGA signal.

PC	Resolution		Horizontal Frequency	Vertical Frequency	VESA Standard
PC	VGA	720 x 400	31.46 kHz	70.08 Hz	—
		640 x 480	31.47 kHz	59.94 Hz	○
			37.50 kHz	75.00 Hz	○
	SVGA	800 x 600	37.88 kHz	60.32 Hz	○
			48.08 kHz	72.19 Hz	○
			46.88 kHz	75.00 Hz	○
			48.36 kHz	60.00 Hz	○
	XGA	1024 x 768	56.48 kHz	70.07 Hz	○
			60.02 kHz	75.03 Hz	○
			47.71 kHz	59.79 Hz	○
	WXGA	1366 x 768	47.71 kHz	59.79 Hz	○
* WUXGA	1920 x 1080	66.58 kHz	59.94 Hz	○	

* Only LC-46SV50U / LC-42SV50U support this timing, LC-32SV40U doesn't support it.

Appendix

RS232 Port Specifications

PC control of the TV

- Attach an RS-232C cable cross-type (commercially available) to the supplied Din/D-Sub RS-232C for the connections.

NOTE

- This operation system should be used by a person who is accustomed to using computers.

Communication conditions

Set the RS-232C communication settings on the PC to match the TV's communication conditions. The TV's communication settings are as follows:

Baud rate:	9,600 bps
Data length:	8 bits
Parity bit:	None
Stop bit:	1 bit
Flow control:	None

Communication procedure

Send the control commands from the PC via the RS-232C connector.

The TV operates according to the received command and sends a response message to the PC. Do not send multiple commands at the same time. Wait until the PC receives the OK response before sending the next command.

Command table

- Commands not indicated here are not guaranteed to operate.

CONTROL ITEM		COMMAND	PARAMETER	CONTROL CONTENTS				
POWER ON COMMAND SETTING	RS	P	0	Off The Power On command rejected.				
	RS	P	1	On The Power On command accepted.				
POWER SETTING	P	0	0	Power Off It shifts to standby.				
	P	1	0	Power On The Power On Command must be waited until system is completely Power Off (LED power indicator turns to be Red).				
INPUT SELECTION A	TOGGLE	I	T	(Toggle) It input-switches by the toggle. (It is the same as an input change key)				
	TV	I	T	0 It input-switches to TV. (A channel remains as it is. (Last memory))				
AV MODE SELECTION	INPUT1-6	I	A	1-6 It input-switches to INPUT1-INPUBT.				
VOLUME	A	V	M	0 0(TOGGLE), 1:STANDARD, 2:MOVE, 3:GAME, 4:PC, 5:DYNAMIC, 6:DYNAMIC(PRE), 7:USER				
	V	O	L	M	* * * * * Volume (0-100)			
POSITION	H-POSITION	H	P	O	S	* * * * *	Only PC mode. (0-100, menu display range +/- 50)	The screen position variable ranges depend on the View Mode or the signal type. The ranges can be seen on the position-setting screen.
	V-POSITION	V	P	O	S	* * * * *	Only PC mode. (0-140, menu display range +/- 20)	
	CLOCK	C	L	C	K	* * * * *	Only PC mode. (0-180, menu display range +/- 90)	
	PHASE	P	H	S	E	* * * * *	Only PC mode. (0-140, menu display range +/- 20)	
VIEW MODE	W	I	D	E	* * * * *	0:(Toggle) 1:Normal 2:S.Stretch 3:Stretch 4:Zoom 5:Full Screen 6:Dot by Dot 7:Cinema	0: Although it can choose now, it is toggle operation in available items. 1: Available in [AV] SD timing and [PC] except some timing (*) 2,3,4: Only available when [AV] signal is being input. 5: Available in [AV] 720p and [PC] except 1280x720, 1920x1080 timing. 6: Available in [AV] 1080 and 1080p timing and [PC] except 1600x1200, 1280x1024(LC-32SV40U) and 1400x1050(LC-32SV40U). 7: Only available in [PC] except some timing(*) (*)1:360x768, 1366x768, 1280x1024, 1400x1050, 1600x1200, 1920x1080 (*)2:1360x768, 1366x768, 1280x720, 1600x1080	
	MUTE	M	U	T	E	* * * * *	0: (Toggle), 1: On, 2: Off	
SURROUND	A	C	S	U	* * * * *	0: (Toggle), 1: On, 2: Off		
AUDIO SELECTION	A	C	H	A	x	* * * * *	(Toggle)	
SLEEP TIMER	O	F	T	M	* * * * *	0: Off, 1: OFF TIMER - 30 MIN., 2: OFF TIMER - 60 MIN., 3: OFF TIMER - 90 MIN., 4: OFF TIMER - 120 MIN.		
CHANNEL	DIRECT CHANNEL (ANALOG)	D	C	C	H	* * * * *	The channel number of TV (1-135)	An input change is included if it is not TV display. In Air, 2-4ch is effective. In Cable, 1-135ch is effective.
	DIRECT CHANNEL (DIGITAL)	D	A	2	P	* * * * *	(0100-9999)	DIGITAL Air (Two-Part numbers, 2-digit plus 2-digit)
		D	C	2	U	* * * * *	(1-999)	DIGITAL Cable (Two-Part numbers, 3-digit plus 3-digit)
		D	C	2	L	* * * * *	(0-999)	Front half of DIGITAL CABLE CHANNEL NO. (Designate major channel)
		D	C	1	0	* * * * *	(0-9999)	DIGITAL Cable (Two-Part numbers, 3-digit plus 3-digit)
		D	C	1	1	* * * * *	(0-8389)	Rear half of DIGITAL CABLE CHANNEL NO. (Designate minor channel)
CH UP	C	H	U	P	x	* * * * *	The channel number of TV + 1	DIGITAL Cable (One-Part numbers, 5-digit, less than 10,000)
CH DOWN	C	H	D	W	x	* * * * *	The channel number of TV - 1	DIGITAL Cable (One-Part numbers, 5-digit, more than 10,000)
CC	C	L	C	P	x	* * * * *	(Toggle)	If it is not TV display, it will input-switch to TV. (same function as CH▲) If it is not TV display, it will input-switch to TV. (same function as CH▼) Toggle operation of a closed caption.

NOTE

- If an underbar (_) appears in the parameter column, enter a space.
- If an asterisk (*) appears, enter a value in the range indicated in brackets under CONTROL CONTENTS.
- Any numerical value can replace the "x" on the table.

Command format

Eight ASCII codes + CR

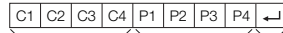

Command 4-digits Parameter 4-digits Return code

Command 4-digits: Command. The text of four characters.
Parameter 4-digits: Parameter 0-9, x, blank, ?

Parameter

Input the parameter values, aligning left, and fill with blank(s) for the remainder. (Be sure that 4 values are input for the parameter.)

When the input parameter is not within an adjustable range, "ERR" returns. (Refer to "Response code format".) Any numerical value can replace the "x" on the table.

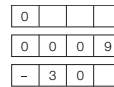

When "?" is input for some commands, the present setting value responds.

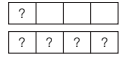

Response code format

Normal response

Problem response (communication error or incorrect command)



Return code (ODH)



Return code (ODH)

Appendix

Information on the Software License for This Product

■ Software composition

The software included in this product is comprised of various software components whose individual copyrights are held by SHARP or by third parties.

■ Software developed by SHARP and open source software

The copyrights for the software components and various relevant documents included with this product that were developed or written by SHARP are owned by SHARP and are protected by the Copyright Act, international treaties, and other relevant laws. This product also makes use of freely distributed software and software components whose copyrights are held by third parties. These include software components covered by a GNU General Public License (hereafter GPL), a GNU Lesser General Public License (hereafter LGPL) or other license agreement.

■ Obtaining source code

Some of the open source software licensors require the distributor to provide the source code with the executable software components. GPL and LGPL include similar requirements. For information on obtaining the source code for the open source software and for obtaining the GPL, LGPL, and other license agreement information, visit the following website:

<http://www.sharpusa.com/gpl>

We are unable to answer any questions about the source code for the open source software. The source code for the software components whose copyrights are held by SHARP is not distributed.

■ Acknowledgements

The following open source software components are included in this product:

- linux kernel/busybox/uClibc/zlib/libpng/libjpeg

CLEARING THE MASTER PASSWORD

If you forgot the password number, reset the secret number by following the procedures below:

1. Press **MENU**
2. Select "**InitialSetup**", press "**ENTER**"
3. Select "**Individual Setup**", press "**ENTER**"
4. Press number 7071
5. Select "**Secret No.**"
6. Enter new password

NOTE

- As a precautionary measure, make a note of your secret number above, cut it from this manual, and keep it in a safe place.

Appendix

Legal notices

■ FCC Part 15

This device complies with Part 15 of the FCC Rules. Operation of this product is subject to the following two conditions: (1) this device may not cause harmful interference, and (2) this device must accept any interference received, including interference that may cause undesired operation.

This equipment has been tested and found to comply within the limits for a class B digital device, pursuant to Part 15 of the FCC Rules. These limits are designed to provide reasonable protection against harmful interference in a residential installation. This equipment generates, uses, and can radiate radio frequency energy and, if not installed and used in accordance with the instructions, may cause harmful interference to radio communications. However, there is no guarantee that interference will not occur in a particular installation. If this equipment does cause harmful interference to radio or television reception, which can be determined by turning the equipment off and on, the user is encouraged to try to correct the interference by one or more of the following measures:

- Reorient or relocate the receiving antenna.
- Increase the separation between the equipment and receiver.
- Connect the equipment into an outlet on a circuit different from that to which the receiver is connected.
- Consult the dealer or an experienced radio/TV technician for help.

■ FCC warning

Changes or modifications not expressly approved by the party responsible for compliance with the FCC Rules could void the user's authority to operate this equipment.

■ Cables

Connections to this device must be made with shielded cables with metallic RF/EMI connector hoods to maintain compliance with FCC Rules and Regulations.

■ Canadian notice

This Class B digital apparatus complies with Canadian ICES-003.

Cet appareil numérique de la classe B est conforme à la norme NMB-003 du Canada.
"Standard Television Receiving Apparatus-Appareil de réception télévision ordinaire, Canada BETS-7 / NTMR-7".

Calling for Service

For location of the nearest Sharp Authorized Service, or to obtain product literature, accessories, supplies, or customer assistance, please call 1-800-BE-SHARP.

LIMITED WARRANTY

CONSUMER LIMITED WARRANTY

SHARP ELECTRONICS CORPORATION warrants to the first consumer purchaser that this Sharp brand Liquid Crystal Display product (the "Product"), when shipped in its original container, will be free from defective workmanship and materials, and agrees that it will, at its option, either repair the defect or replace the defective Product or part thereof with a new or remanufactured equivalent at no charge to the purchaser for parts or labor for the period(s) set forth below.

This warranty does not apply to any appearance items of the Product or if the serial number or model number affixed to the Product has been removed, defaced, changed, altered or tampered with. This warranty does not cover installation or signal reception problems. This limited warranty will not apply if the Product has been or is being used in a commercial setting or application; this warranty is meant solely for the non-commercial, household use of the Product by consumers in their home or residence. If you intend to or already use this Product for commercial purposes or in a commercial setting, there are warranties available to cover your use of this Product, the terms of which may vary. Please contact 1-800-BE-SHARP for further information.

In order to enforce your rights under this limited warranty, you should follow the steps set forth below. You must be able to provide proof of purchase to the servicer, which proof must include the date of purchase.

To the extent permitted by applicable state law, the warranties set forth are in lieu of, and exclusive of, all other warranties, express or implied. Specifically ALL OTHER WARRANTIES OTHER THAN THOSE SET FORTH ABOVE ARE EXCLUDED, ALL EXPRESS AND IMPLIED WARRANTIES INCLUDING THE WARRANTIES OF MERCHANTABILITY, FITNESS FOR USE, AND FITNESS FOR A PARTICULAR PURPOSE ARE SPECIFICALLY EXCLUDED. IF, UNDER APPLICABLE STATE LAW, IMPLIED WARRANTIES MAY NOT VALIDLY BE DISCLAIMED OR EXCLUDED, THE DURATION OF SUCH IMPLIED WARRANTIES IS LIMITED TO THE PERIOD(S) FROM THE DATE OF PURCHASE SET FORTH BELOW. THIS WARRANTY GIVES YOU SPECIFIC LEGAL RIGHTS. YOU MAY ALSO HAVE OTHER RIGHTS WHICH VARY FROM STATE TO STATE.

The warranties given herein shall be the sole and exclusive warranties granted by Sharp and shall be the sole and exclusive remedy available to the purchaser and only for the time periods set forth herein. No other representations or promises made by anyone are permitted. Correction of defects, in the manner and for the period of time described herein, shall constitute complete fulfillment of all liabilities and responsibilities of Sharp to the purchaser with respect to the Product, and shall constitute full satisfaction of all claims, whether based on contract, negligence, strict liability or otherwise. Sharp does not warrant nor shall Sharp be liable, or in any way responsible, for Products which have been subject to abuse (including, but not limited to, improper voltage), accident, misuse, negligence, lack of reasonable care, alteration, modification, tampering, misuse, improper operation or maintenance or any damages or defects in the Product which were caused by repairs or attempted repairs performed by anyone other than a Sharp authorized servicer. Nor shall Sharp be liable or in any way responsible for any incidental or consequential economic or property damage. Some states do not allow limits on warranties or on remedies for breach in certain transactions; in such states, the limits herein may not apply.

THIS LIMITED WARRANTY IS VALID ONLY IN THE FIFTY (50) UNITED STATES, THE DISTRICT OF COLUMBIA, AND PUERTO RICO

Model Specific Section

Your Product Model Number & Description:

LC-46SV50U, LC-42SV50U, LC-32SV40U LCD Color Television
(Be sure to have this information and Proof of Purchase available when you need service for your Product.)

Warranty Period for this Product:

One (1) year parts and labor from date of purchase.

Additional Exclusions from Warranty Coverage (if any):

Image Retention resulting from a fixed image being displayed for long periods of time is not covered by this Limited Warranty (see Operation Manual on how to prevent this).

Service is provided by a Sharp Authorized Service Center in the United States. To find the location of the nearest Sharp Authorized Service Center, call Sharp toll free at 1-800-BE-SHARP. Sharp will provide instructions on service options available for your Product.

What to do to Obtain Service:

If it is deemed the Product is to be shipped for servicing, be sure it is insured and packaged securely. Please use two persons to carry the Product, transport it in original packaging or packaging that provides comparable protection of the Product, and ensure that the Product is covered to avoid scratches and damage. Sharp shall not be responsible for lost, stolen or misdirected mail or for damage to the product incurred during shipping.

For Products that are deemed in home service, a servicer will come to your location. If necessary, the servicer may remove the unit for repair at the service facility and return it once completed. In home service is not available in all areas and Sharp may, at our option, elect to provide transportation of the Product to and from an Authorized Service Center in those areas.

TO OBTAIN PRODUCT INFORMATION OR PURCHASE ACCESSORIES, CALL 1-800-BE-SHARP OR VISIT www.SharpUSA.com

SHARP®

SHARP ELECTRONICS CORPORATION

Sharp Plaza, Mahwah, New Jersey 07495-1163

SHARP CORPORATION

Dimensional Drawings

LC-46SV50U

Unit: inch (mm)
Unité: pouce (mm)
Unidad: pulgada (mm)

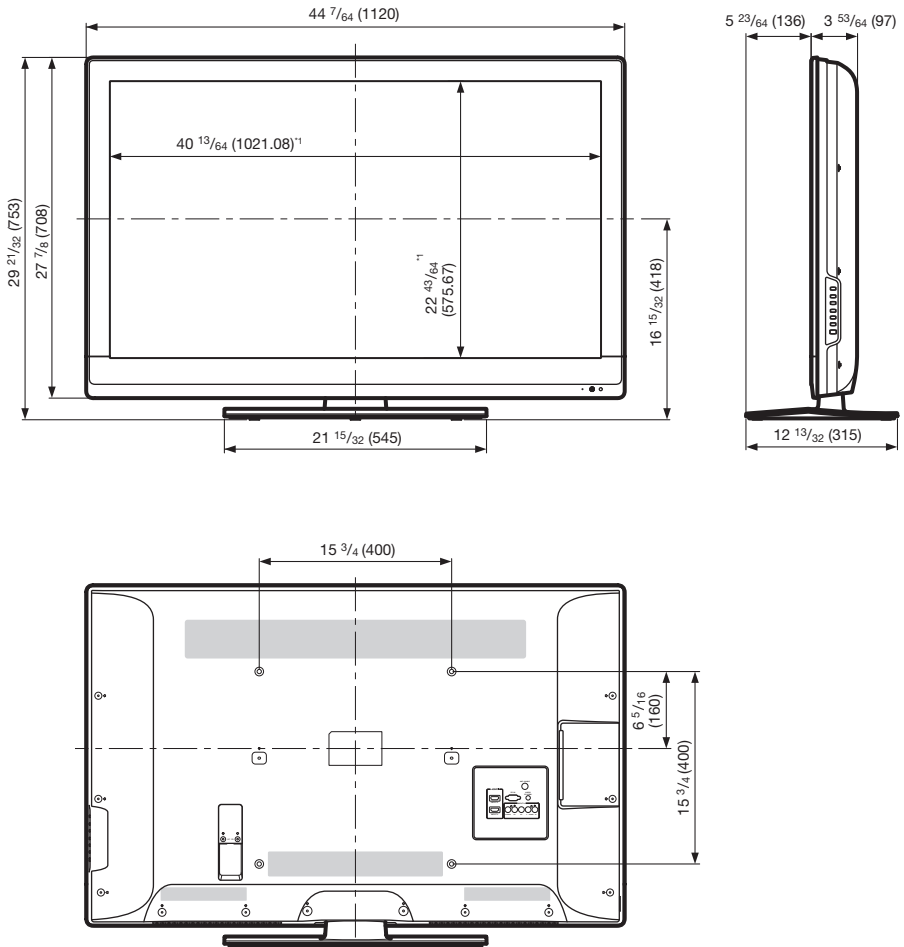

¹⁾ Active area/Área activa/Zone active

Dimensional Drawings

LC-42SV50U

Unit: inch (mm)
Unité: pouce (mm)
Unidad: pulgada (mm)

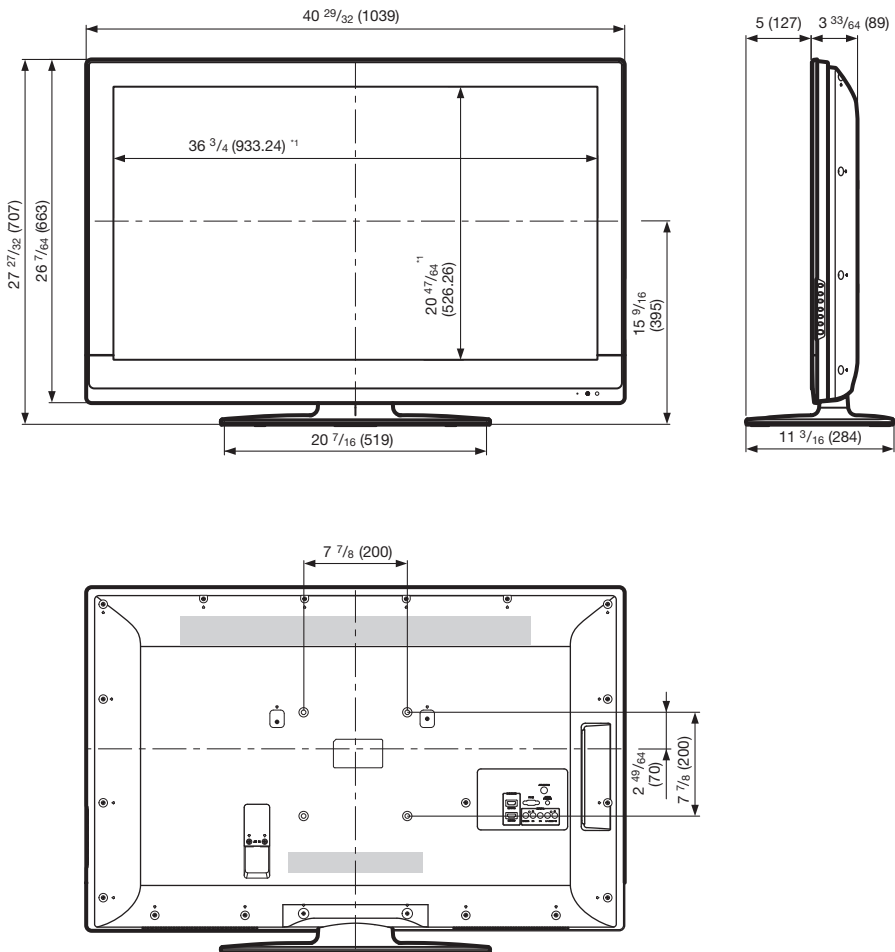

¹ Active area/Área activa/Zone active

Dimensional Drawings

LC-32SV40U

Unit: inch (mm)
Unité: pouce (mm)
Unidad: pulgada (mm)

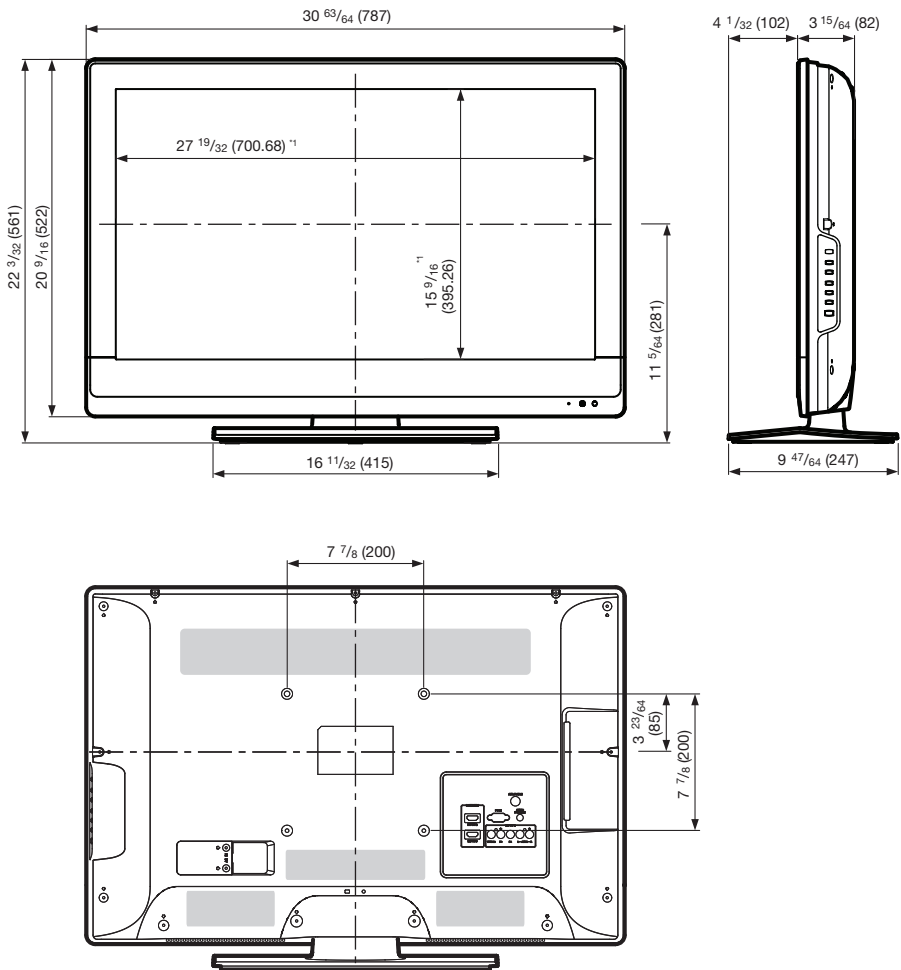

¹ Active area/Área activa/Zone active

² Thinnest part/Parte más delgada/Partie la plus mince

SHARP®

SHARP ELECTRONICS CORPORATION

Sharp Plaza, Mahwah, New Jersey 07495-1163

SHARP CORPORATION

Printed in China
Imprimé au Chine
Impreso en China
XXXXXXXXXXXXXX