

SONY

Model: KDL-65HX729

Description: LCD TV

Dimensions: 59' 36 5/8" 14 5/8" (WHD):

(WHD): 59' 35 3/8" 2 1/4" w/o stand

Weight: 128 lb

Carton Dimensions: tbd

(WHD):

Power 120V AC

requirements: 60HZ

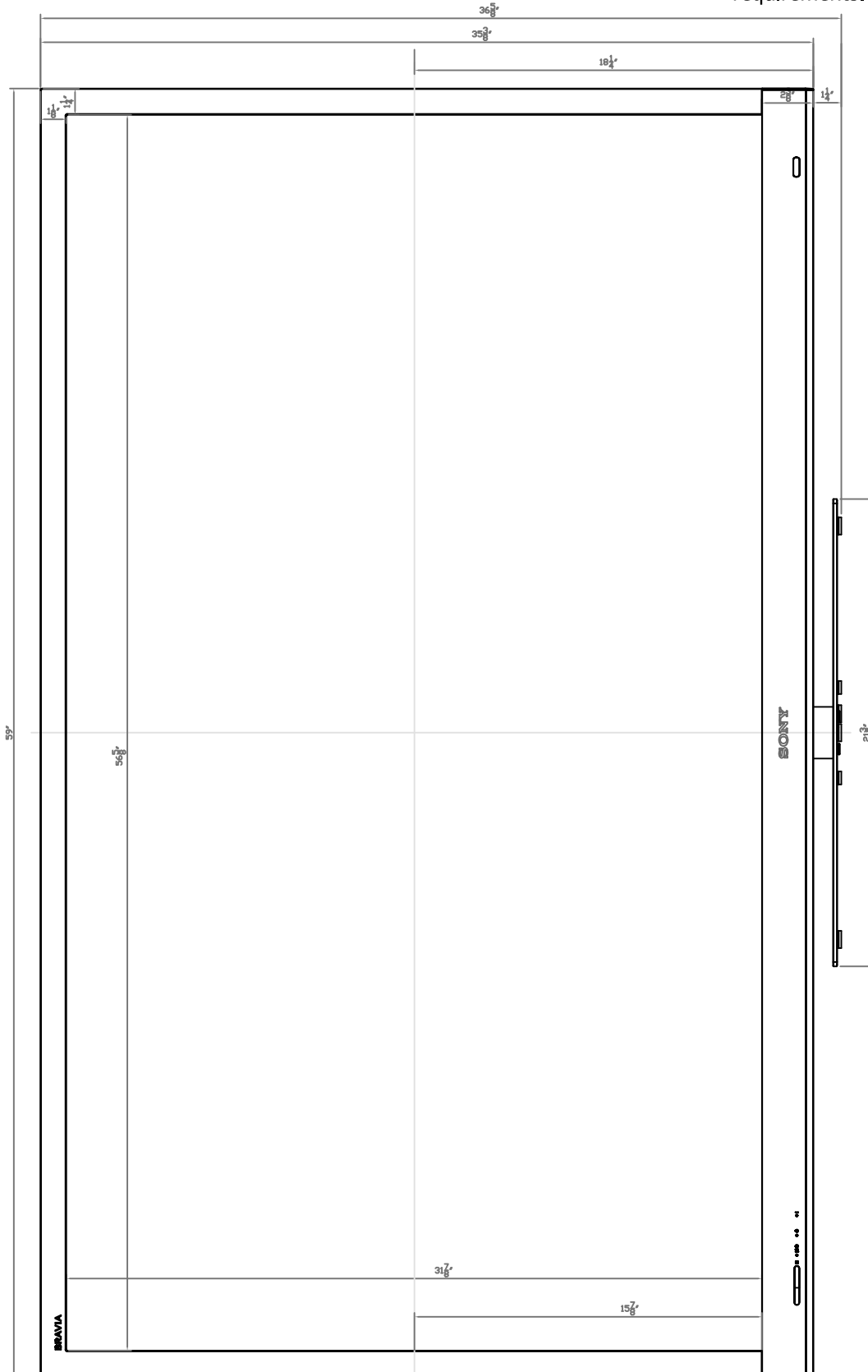

NOTE:

WHERE THERE ARE CLOSE TOLERANCES INVOLVED IN CABINET BUILDING OR APPLICATIONS WHICH REQUIRE A GREAT DEGREE OF PRECISION, WE RECOMMEND THAT THE PRODUCT ITSELF BE USED TO MAKE THE ACTUAL MEASUREMENTS. SONY WILL NOT BE HELD RESPONSIBLE FOR INACCURACIES IN THE DESIGN OR MANUFACTURE OF ENCLOSURES.

Consumer Integrated Systems - Park Ridge, New Jersey 07656 - Fax (201)930-7891 - www.sony.com/dn

SONY

Model: KDL-65HX729

Description: LCD TV

Dimensions: 59" 36 5/8" 14 5/8" (WHD):

(WHD): 59" 35 3/8" 2 1/4" w/o stand

Weight: 128 lb

Carton Dimensions: tbd (WHD):

Power requirements: 120V AC 60HZ

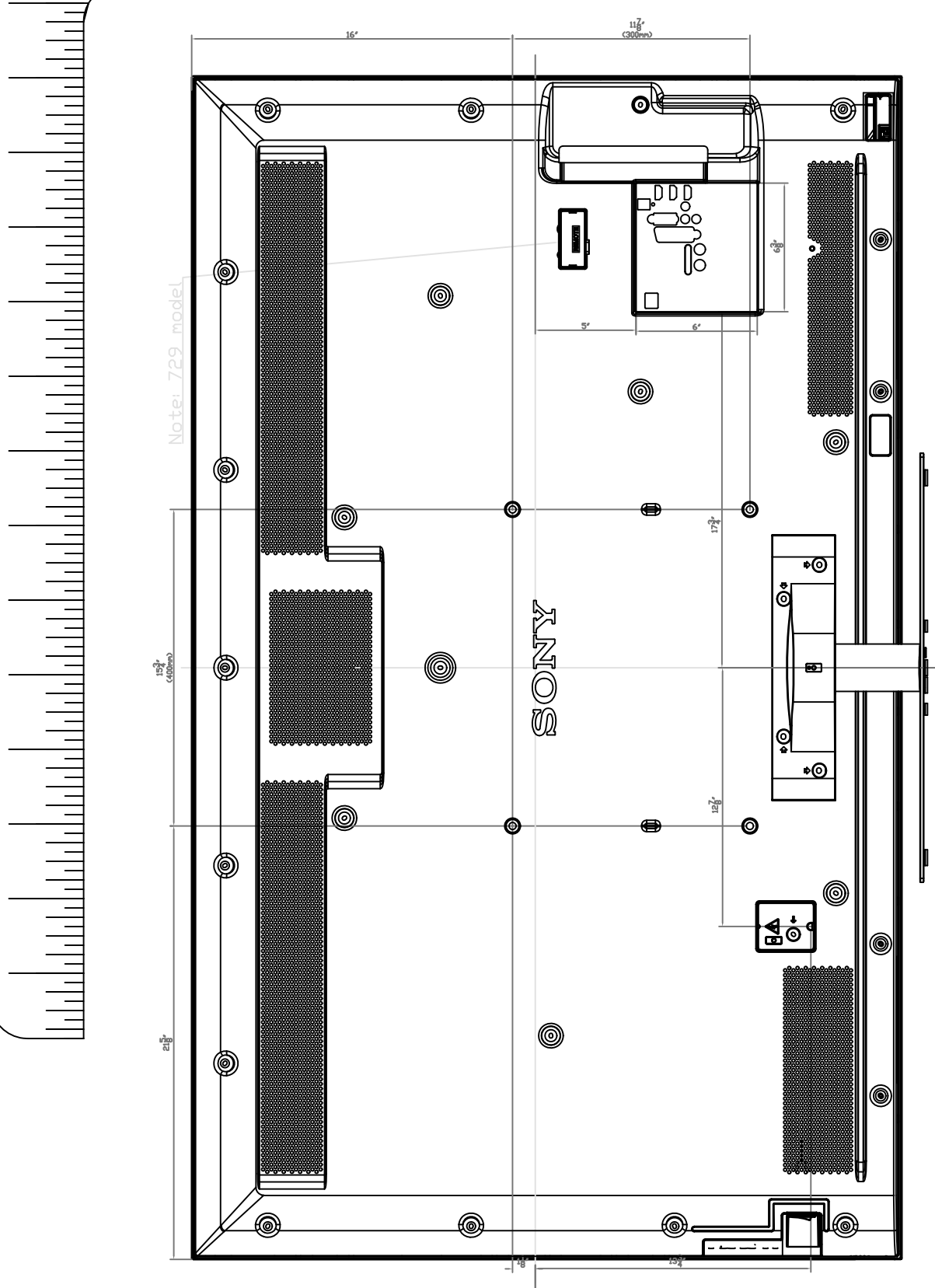

NOTE:

WHERE THERE ARE CLOSE TOLERANCES INVOLVED IN CABINET BUILDING OR APPLICATIONS WHICH REQUIRE A GREAT DEGREE OF PRECISION, WE RECOMMEND THAT THE PRODUCT ITSELF BE USED TO MAKE THE ACTUAL MEASUREMENTS. SONY WILL NOT BE HELD RESPONSIBLE FOR INACCURACIES IN THE DESIGN OR MANUFACTURE OF ENCLOSURES.

Consumer Integrated Systems - Park Ridge, New Jersey 07656 - Fax (201)930-7891 - www.sony.com/dn

Features and specifications subject to change without notice. Non-Metric weights and measurements are approximate.

SONY

Model: KDL-65HX729

Description: LCD TV

Dimensions: 59' 36 5/8" 14 5/8" (WHD):

(WHD): 59' 35 3/8" 2 1/4" w/o stand

Weight: 128 lb

Carton Dimensions: tbd

(WHD):

Power 120V AC
requirements: 60HZ

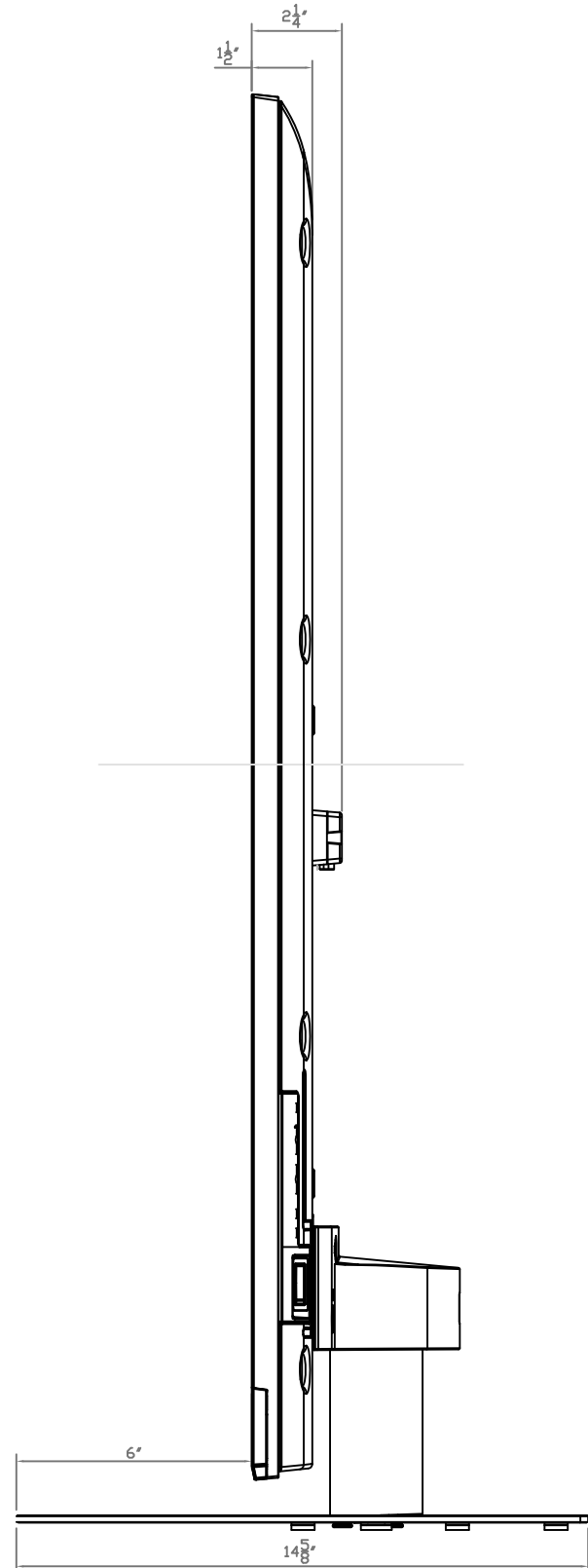
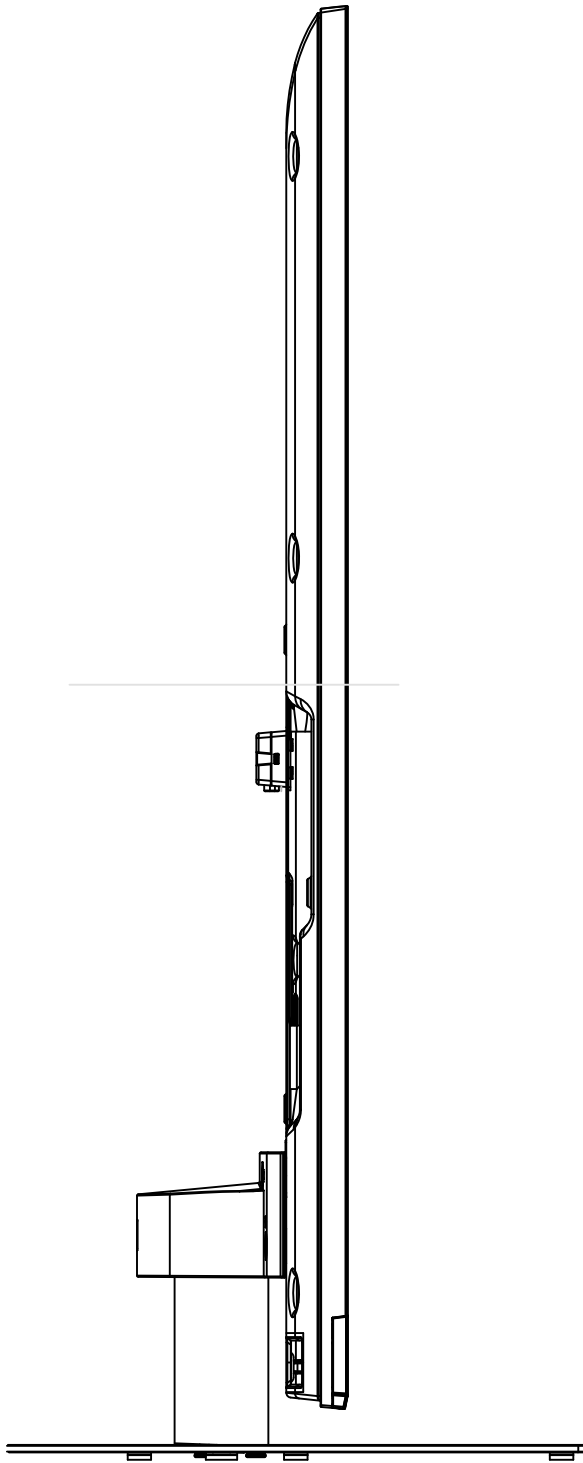
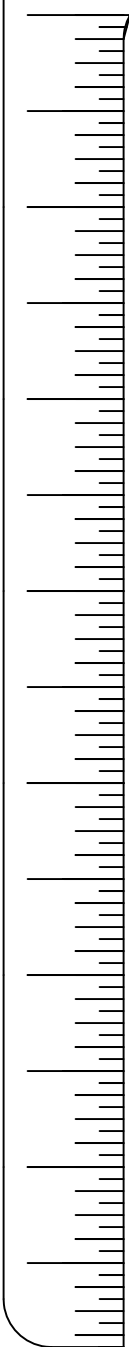

NOTE:

WHERE THERE ARE CLOSE TOLERANCES INVOLVED IN CABINET BUILDING OR APPLICATIONS WHICH REQUIRE A GREAT DEGREE OF PRECISION, WE RECOMMEND THAT THE PRODUCT ITSELF BE USED TO MAKE THE ACTUAL MEASUREMENTS. SONY WILL NOT BE HELD RESPONSIBLE FOR INACCURACIES IN THE DESIGN OR MANUFACTURE OF ENCLOSURES.

Consumer Integrated Systems - Park Ridge, New Jersey 07656 - Fax (201)930-7891 - www.sony.com/dn

Features and specifications subject to change without notice. Non-Metric weights and measurements are approximate.

SONY

Model: KDL-65HX729

Description: LCD TV

Dimensions: 59" 36 5/8" 14 5/8" (WHD):

(WHD): 59" 35 3/8" 2 1/4" w/o stand

Weight: 128 lb

Carton Dimensions: tbd

Power requirements: 120V AC 60HZ

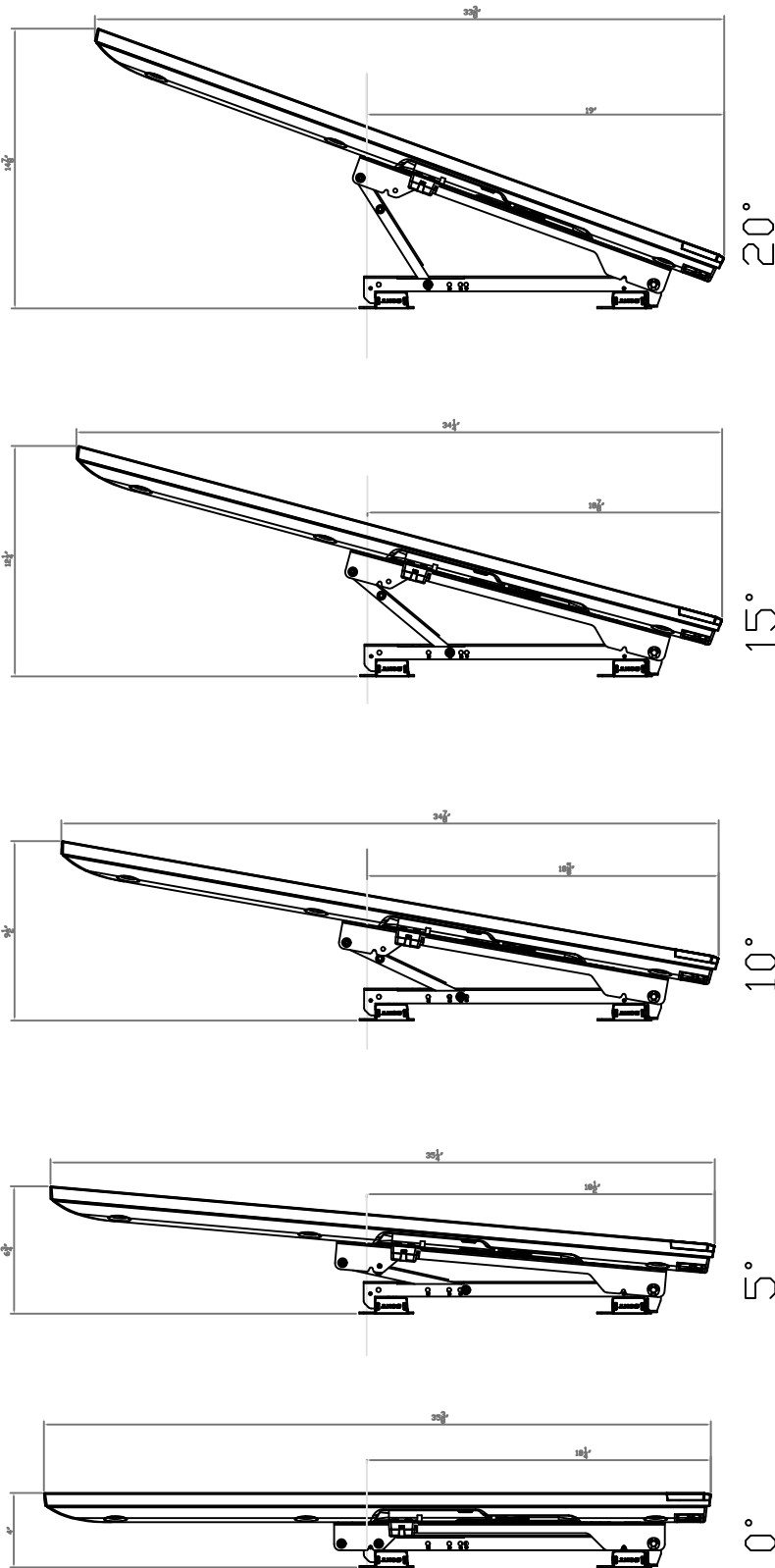

NOTE:

WHERE THERE ARE CLOSE TOLERANCES INVOLVED IN CABINET BUILDING OR APPLICATIONS WHICH REQUIRE A GREAT DEGREE OF PRECISION, WE RECOMMEND THAT THE PRODUCT ITSELF BE USED TO MAKE THE ACTUAL MEASUREMENTS. SONY WILL NOT BE HELD RESPONSIBLE FOR INACCURACIES IN THE DESIGN OR MANUFACTURE OF ENCLOSURES.

Consumer Integrated Systems - Park Ridge, New Jersey 07656 - Fax (201)930-7891 - www.sony.com/dn

Features and specifications subject to change without notice. Non-Metric weights and measurements are approximate.

SONY

Model: KDL-65HX729

Description: LCD TV

Dimensions: 59' 36 5/8' 14 5/8' (WHD):

(WHD): 59' 35 3/8' 2 1/4' w/o stand

Weight: 128 lb

Carton Dimensions: tbd

Power requirements: 120V AC 60HZ

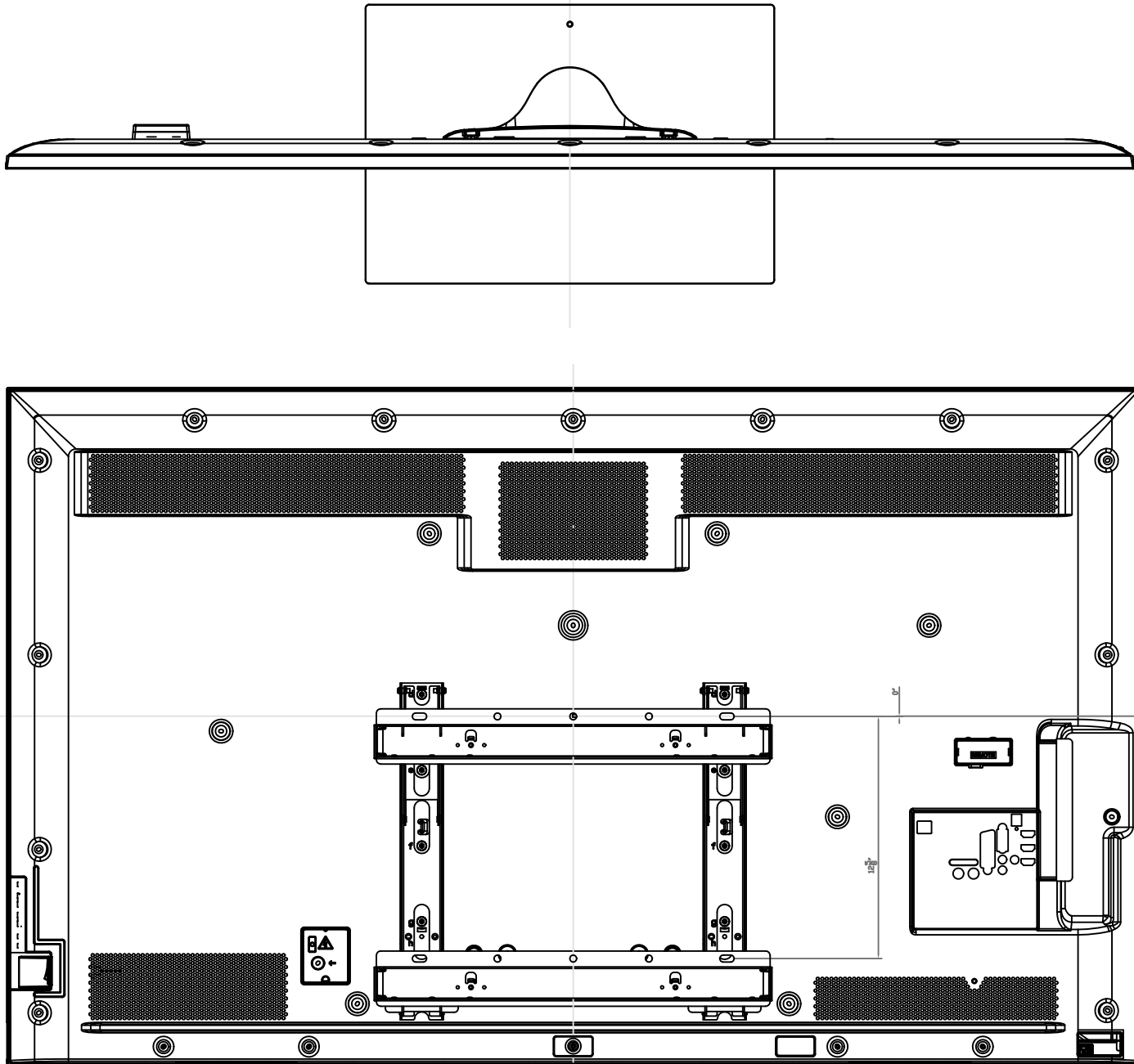

SU-WL500

NOTE:

WHERE THERE ARE CLOSE TOLERANCES INVOLVED IN CABINET BUILDING OR APPLICATIONS WHICH REQUIRE A GREAT DEGREE OF PRECISION, WE RECOMMEND THAT THE PRODUCT ITSELF BE USED TO MAKE THE ACTUAL MEASUREMENTS. SONY WILL NOT BE HELD RESPONSIBLE FOR INACCURACIES IN THE DESIGN OR MANUFACTURE OF ENCLOSURES.

Consumer Integrated Systems - Park Ridge, New Jersey 07656 - Fax (201)930-7891 - www.sony.com/dn

Features and specifications subject to change without notice. Non-Metric weights and measurements are approximate.